

(Disclaimer: All book covers in this manual are for display purposes only, not pre-installed books)

Contents

1.About Bigme	04
2.Standard Accessories	05
3.Safety Guide	06
4.Product View	08
5.Capacitive pen	12
6.Main Interface	14
7.Meeting Records	21
8.Quick Notes	31
9.Bookshelf	36
10.Office Documents	54
11.ChatGPT	56
12.Image Browser	61
13.Application Center	65
14.E ink Center	67
15.Global Handwriting	71
16.Application Split Screen	74
17.Input Method Management	76

18.File Download Transfer	79
19.Floating Ball	90
20.Settings	93
21.Disclaimer	102

1. About Bigme

The founder and core team of Bigme have been engaged in the research and development of e-ink readers since 2008. Over the past 15 years, they have accumulated rich R&D and product experience, with a total shipment of over 8 million units. The products are sold to more than 100 countries, and there are more than 100 offline experience stores in China. The Bigme team pays great attention to the user experience and after-sales service of the products.

2. Standard Accessories

1. E Ink Tablet	x1
2. Capacitive pen	x1
3. Type - C Data Cable	x1
4. Leather Case	x1
5. Pen Refills	x2
6. Pen Refill Clamp	x1
7. Product Instructions	x1
8. Warranty Card	x1
9. Certificate of Conformity	x1

3. Safety Guide

Please read the following safety guidelines before use. If you encounter any technical difficulties, please contact your Bigme retailer, or call the national customer service number 400-0188-938, or send an email to the official email address vip@bigme.vip for assistance.



Screen Protection

The E-ink screen is fragile and easily damaged. Do not directly hit, squeeze, press the screen, or drop it from a height onto a hard surface. If the display screen is broken, stop using it and contact the official or other qualified professionals for replacement. Do not disassemble and replace it yourself.



Qualified Accessories

Only batteries, chargers, and other accessories that meet the safety standards of this device are allowed. Please refer to the product configuration parameters. You will bear the damage caused by the use of incompatible accessories.



Keep Away from Liquids

This device is not waterproof. Do not expose the device to a humid environment, do not use the product in the rain, and keep it away from any corrosive liquids.



Do Not Disassemble

The battery of this device cannot be replaced. Do not disassemble it yourself to avoid structural or screen damage.



Operating Environment

The allowable operating temperature range of this device is 0°C-50°C.

4. Product View

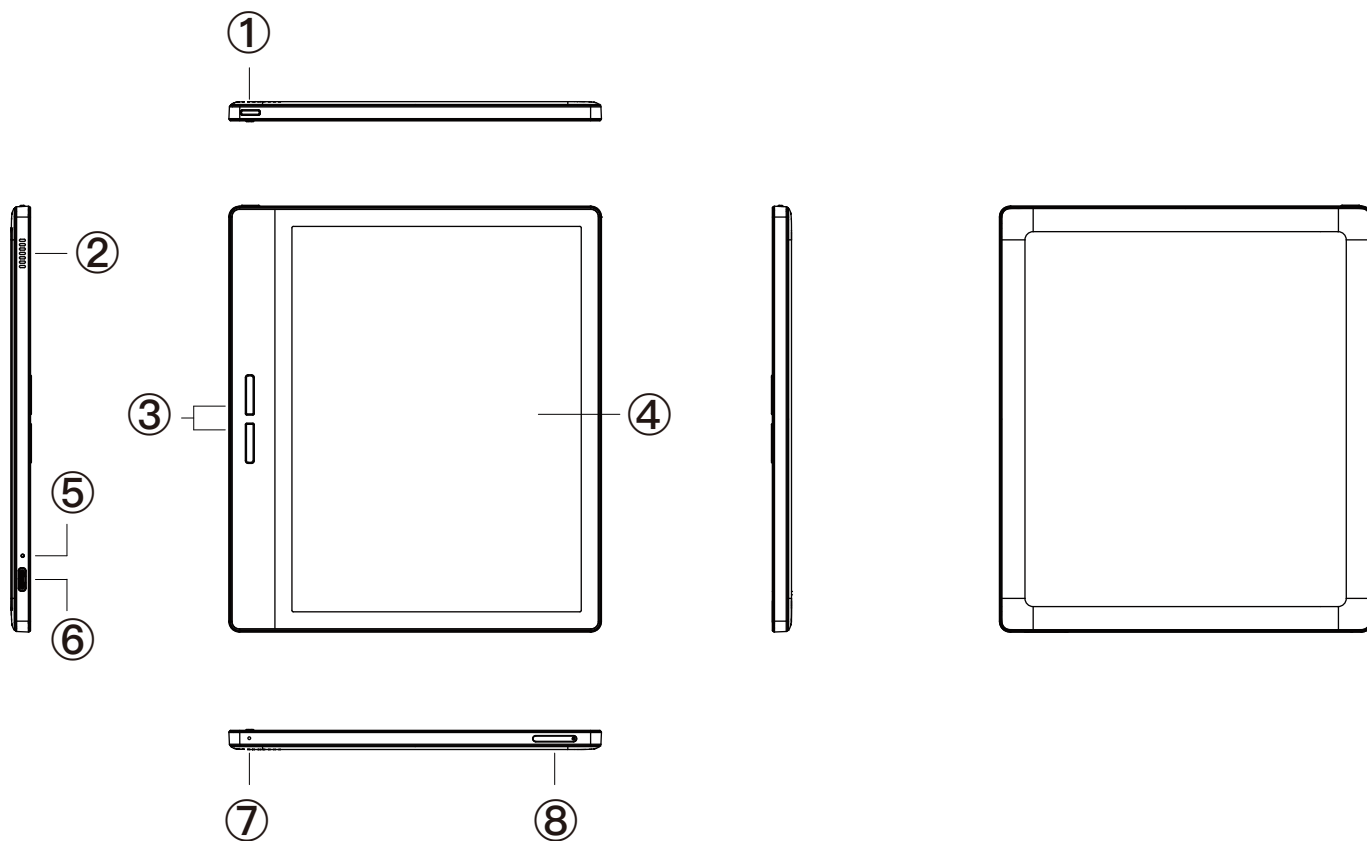

1.Power Button

2.Speaker

3.page turn button

4.E-ink Screen

5.Indicator Light

6.Type-C Interface

7.Microphone

8.TF Card Slot

Button Function Description

1.Power Button/Fingerprint Button:

- Press and hold the power button for 3 seconds to start the device
- Press and hold the power button for 1 second, choose "Shutdown/Restart" in the menu to shutdown/restart the device
- Press the power button and then release immediately, the device enters sleep mode
- Press the power button and then release immediately, wake up the device from sleep mode

2.Indicator Light:

- The indicator light is on, indicating that it is charging and not yet full
- The indicator light is off, indicating that it is fully charged or the Type-C USB cable is not properly inserted

3.Type-C Interface:

Connect the PC host and the device to transfer data through the Type-C data cable, or charge the device

4.TF Card Slot:

- Used for TF card expansion, supports up to 1 TB expansion

Product Specifications

Model	B751C
Size	7 inch color e-ink screen
Overall Size	136.2*155.7*7mm
Display Area Size	105.81*140.96mm
Resolution	1680*1264 B/W 840*632 COLOR
PPI	300PPI B/W 150PPI COLOR
CPU	8-core 2.3GHz
RAM/ROM	4+64GB
Handwriting	Capacitive pen
Expansion	TF card slot(TF card supports up to 1TB expansion)
Microphone	Supported
Speaker	Supported
Wireless Connection	2.4G/5G WIFI Bluetooth 2.1/3.0/4.1/5.0
Front light	36 levels (cold and warm)
Voice transcription	Free
Battery capacity	2300mAh
Operating system	Android 11 open system

5. Capacitive pen

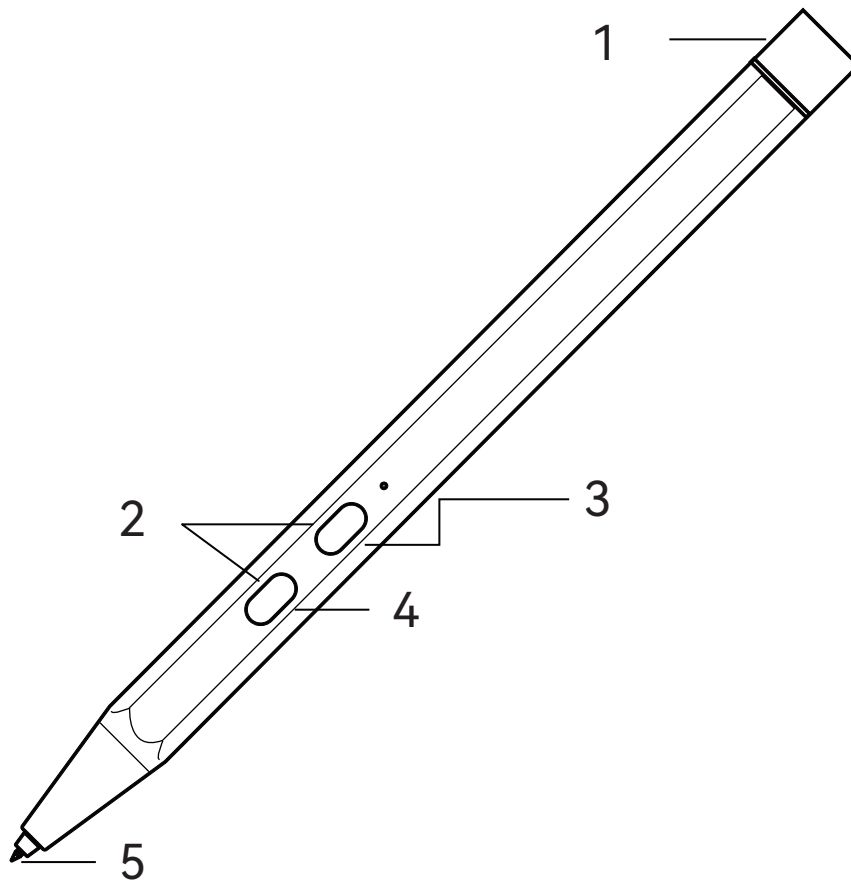

1. Battery cap: Rotate and unscrew to replace the battery
2. Pressure calibration button: Press and hold 2 buttons at the same time for 5s. (Waiting flashlight flashes 2 times)
3. Erase button: range erase
4. Wake-up button: Press the wake-up button to write
5. Pen Nib: Writing and touch in the writing area

Instructions for use

Unscrew the pen cap, insert AAAA alkaline batteries, and wake up by any button on the side, the red indicator light will flash once

Power saving mode

1. If it is not used for more than 3 minutes, the pen will enter power saving mode and can be woken up by any button on the side.
2. If the pen is placed upright and not used for more than 3 minutes, the pen will enter power saving mode and can be woken up by any button on the side

6. Main Interface

System Bar

Menu Bar

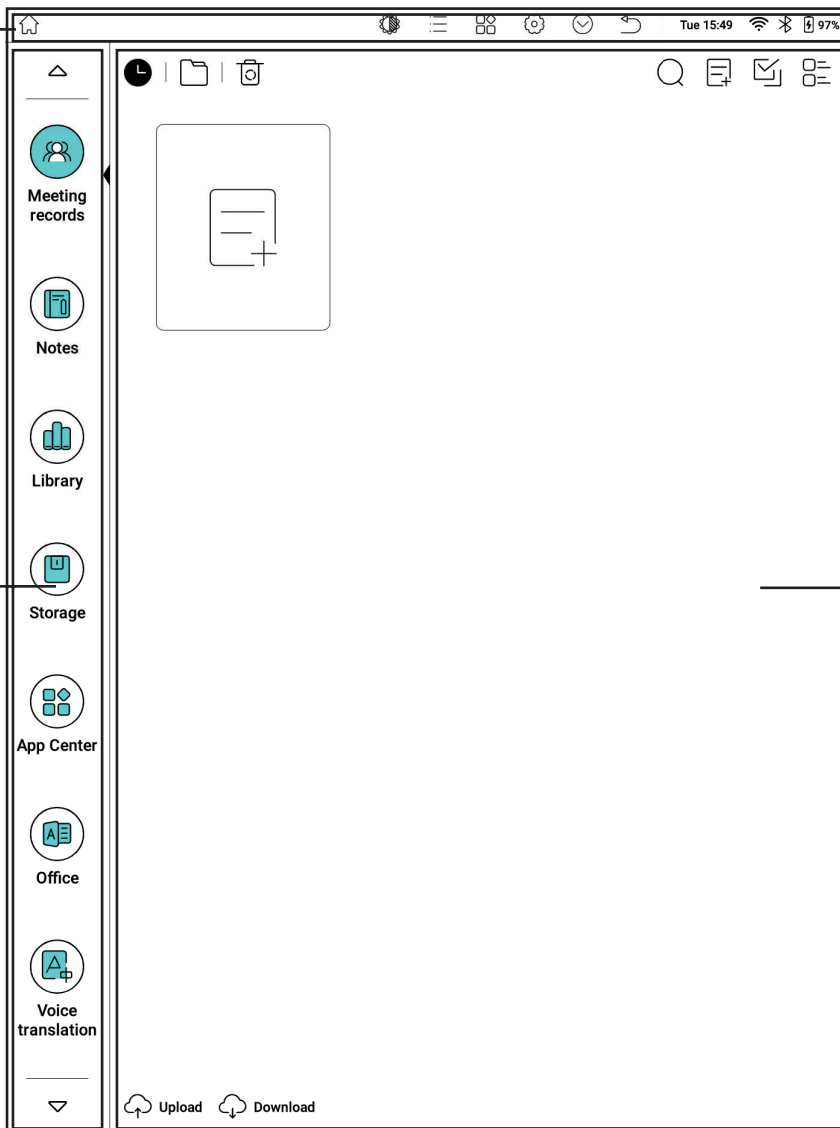

Content Area

Office Mode

System
Bar

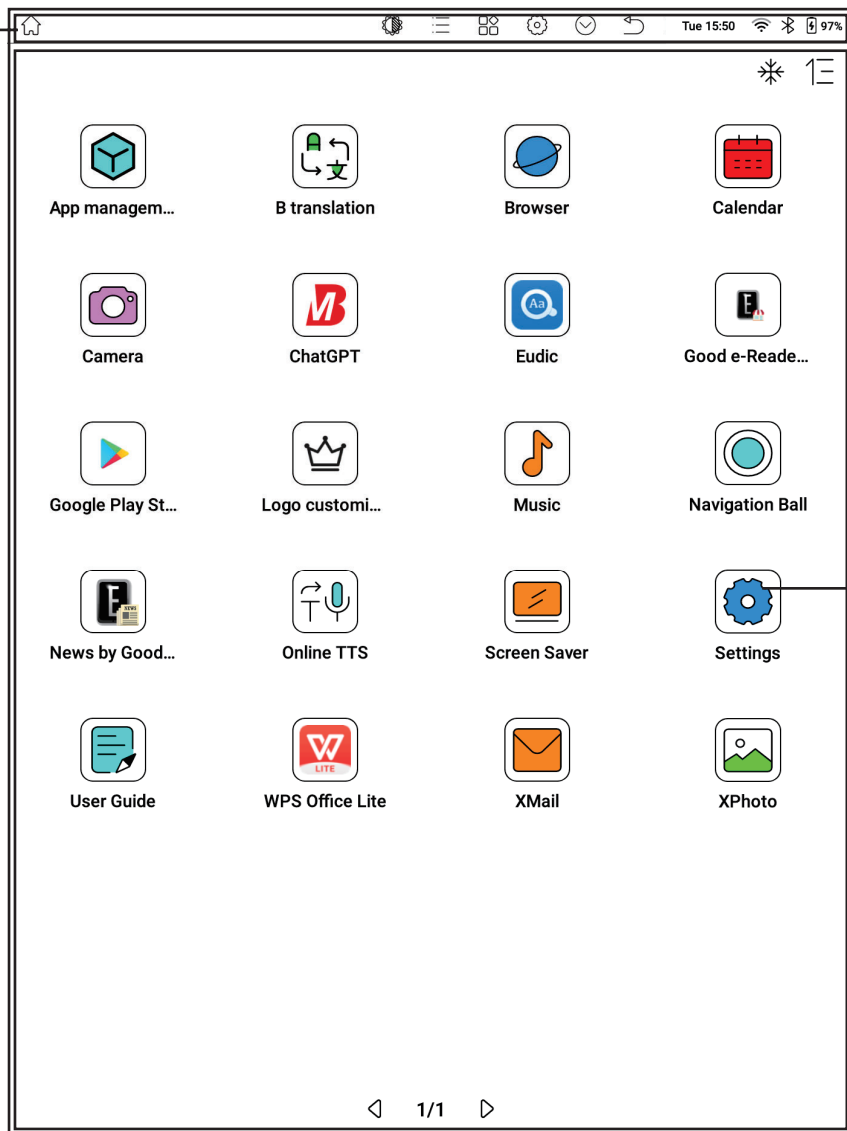

Content
Area

Tablet Mode

Theme Mode: You can click [Settings] > [Homepage Style] to switch between [Office Mode] and [Tablet Mode]

System Bar

1. Displays the current basic status of the device, including: time, WIFI status, Bluetooth, smart pen battery level, device battery level, etc.
2. Convenient operations, including returning to the homepage, application center, EInk center, return, EInk Center, Application process, Settings, etc.
3. Pull down to bring out the status bar

Menu Bar

1. Long press the application, drag to exchange application positions
2. Long press the menu bar or click [Settings - Menu Management] to enter the custom list; click [Switch] to set the shortcut applications in the menu bar

Content Area

1. Under Office Mode: The content area displays the content interface of the selected application
2. Under Tablet Mode: The content area displays the application desktop

Status Bar

Home icon | Settings | App Store | Control Center | Tue 15:53 | Wi-Fi | Bluetooth | 97%

Nov 28, 2023 3:53 PM

XRZ3-5G | **Bluetooth**

Eink center | Global hand... | Split screen | Process man...
Screenshots | Miracast | Speed up | Record screen
Airplane mode | Touch | Power mana... | Screen rotati...

Lights out | Daytime | Night | Bedding | Other

Daytime: 24 | Night: 28

More volume: 0

Navigation icons: XPhoto, XMail, Settings, Screen Saver, Navigation Ball, Music, Good e-Read..., Eudic, Calendar, Browser

Bottom bar: ◀ 1/1

Operation

1. Pull down at the top of the screen to display the [Status Bar]
2. Click on the blank space outside the [Status Bar] to retract the [Status Bar]

WIFI

1. Click to connect or disconnect WIFI
2. Long press to enter the WIFI settings page and set up WIFI

Bluetooth

1. Click to connect or disconnect Bluetooth
2. Long press to enter the Bluetooth settings page and set up Bluetooth

Shortcut Area

Used to display the convenient entrances of functions such as [E ink Center], [Global Handwriting], [Application Split Screen], [Process Management], [Super Screenshot], [One-Key Projection], [One-Key Acceleration], [Screen Recording], [Flight Mode], [Hand Touch], [Settings] and [Homepage]

Reading Light

Can adjust the cold and warm front light freely according to the usage environment and reading habits

Volume

1. Freely adjust the sound volume or mute
2. Can adjust the volume of media, calls, notifications, and alarms separately

7. Meeting Record

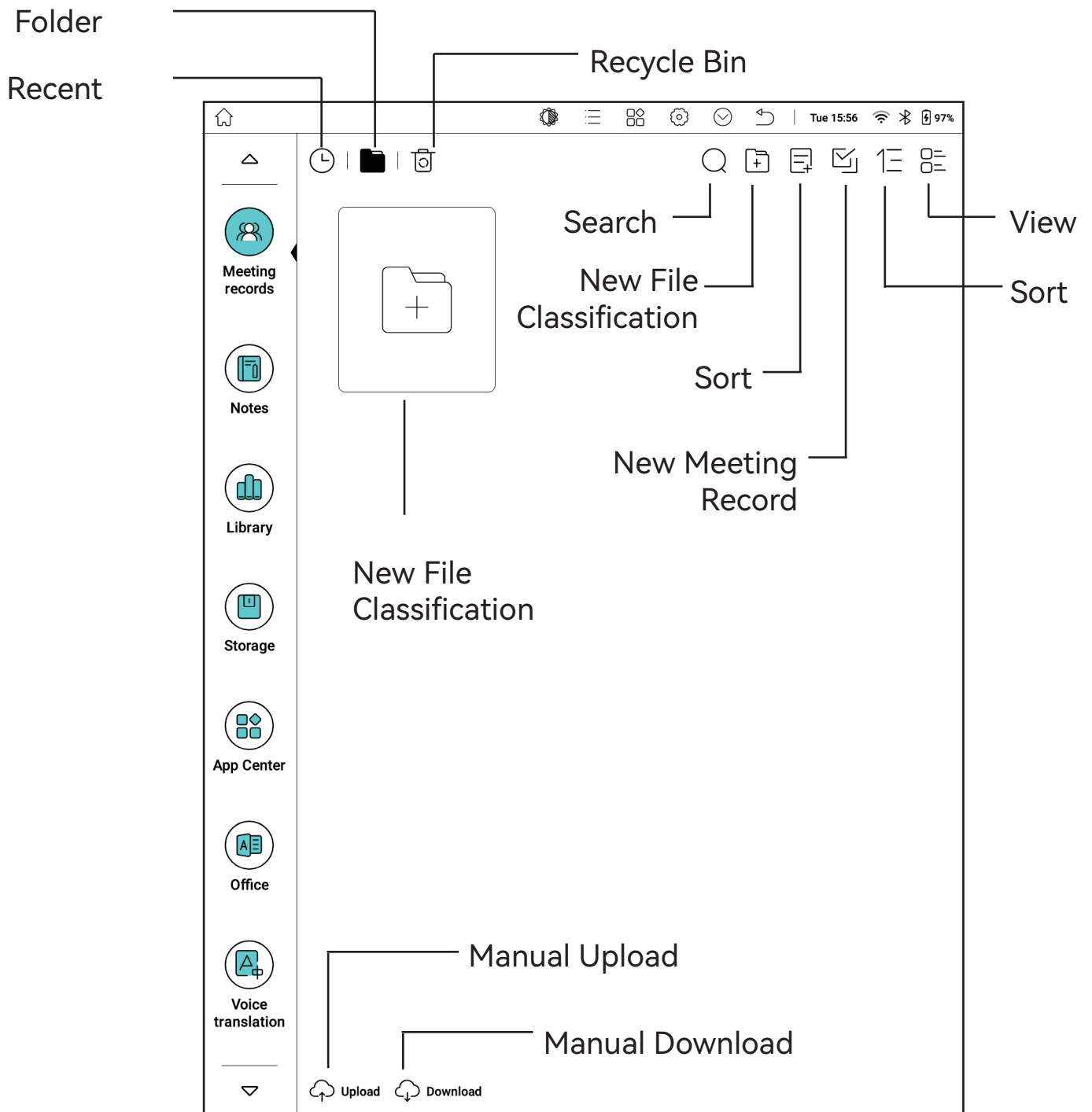

Menu Bar

Save | 2023-11-28 15:08:00 | Record | Settings | Toolbar | Share ex... | More | Undo | Redo | 1/1

Recording and Transcription Area

00:00/00:00 | 00:00/00:10

Cheer for the new era!

View full | Polish | Summary

Writing area

Writing area

Free to write notes or create

New Meeting Record – Basic Menu Bar

1. Save and Exit: You can save or delete meeting record notes
2. Title: You can customize the note name
3. Recording Transcription: You can record the meeting and transcribe it into text
4. Settings: Can freely switch between Chinese dialects and foreign languages; Turn on or off (multiplayer mode), multiple people can be recognized when recording and transcribing; Select professional vocabulary
5. Toolbar: Allows for the display or hiding of the floating toolbar; long press on the floating toolbar to move its position.
6. Sharing and Exporting: Allows for sharing of meeting records to others through QR code, verification code, etc. Also allows for exporting of meeting records as PDF files or TXT files.
7. More: file transcription, OCR, Encrypt, Rotation, Enable Sliding Page Turning, etc.

8. Undo: Returns to the previous operation.
9. Redo: Proceeds to the next operation.
10. Previous Page: Turns to the previous page.
11. Next Page: Turns to the next page or adds a new page.
12. Intelligent Summary: Extracts important information from the meeting content.
13. Intelligent Organization: Optimizes the content of the meeting records.

Creating New Meeting Records – Handwriting Area

1. Allows for freehand note-taking.
2. Allows for template switching.

Creating New Meeting Records – Recording Transcription Area

1. Allows for viewing of transcribed text content from voice recordings.
2. Allows for playback of recorded content.
3. Allows for speed adjustment during playback.
4. Allows for volume adjustment.
5. View Full Text: Allows for viewing of all transcribed content.
6. Playback Recording: Tapping on handwritten content plays corresponding voice recording; tapping on the recording playback progress bar jumps to corresponding transcribed content.
7. Transcription Content Editing: Tapping on transcribed content allows for manual modification or deletion of text.

Creating New Meeting Records - Translation



1. Click on [Recording Transcription] > [Start Translation] > [Select Language].
2. Start recording, and the system will automatically translate.
3. The translated results can be exported in the View Full Textsection.

Creating New Meeting Records - Pen Type and Eraser Selection

The screenshot displays the top toolbar of a meeting application with the following items from left to right: Save, a timestamp '2023-11-28 15:08:00', Record, Settings, Toolbar, Share ex..., More, Undo, Redo, and a page indicator '1/1'. Below the toolbar is a vertical sidebar containing icons for Pen, Pencil, Brush, BallPen, Erase, Insert, Page, Template, Shapes, Photo, Text, Page, and Crop. The 'Brush2' configuration panel is open, showing options for Type (Pen, Pencil, Brush, BallPen, HighLight), Color (a grid of 16 color swatches), and Line width (a slider set to 2). A 'Black(#000000)' label is positioned above the top row of color swatches. A circular arrow icon is located in the top right corner of the configuration panel.

1. Toolbar: Allows for the display or hiding of the toolbar window.
2. Clicking on the pen type in the floating window, such as [Highlighter], allows for adjustment of the color and thickness of the pen stroke.
3. Eraser: Allows for selection of erasure methods such as track erasure, range erasure, or full erasure.
4. Insert: text, pictures, pages, templates, etc. can be inserted
5. Delete this page: Delete the page that currently being edited

Creating New Meeting Records – Template Selection

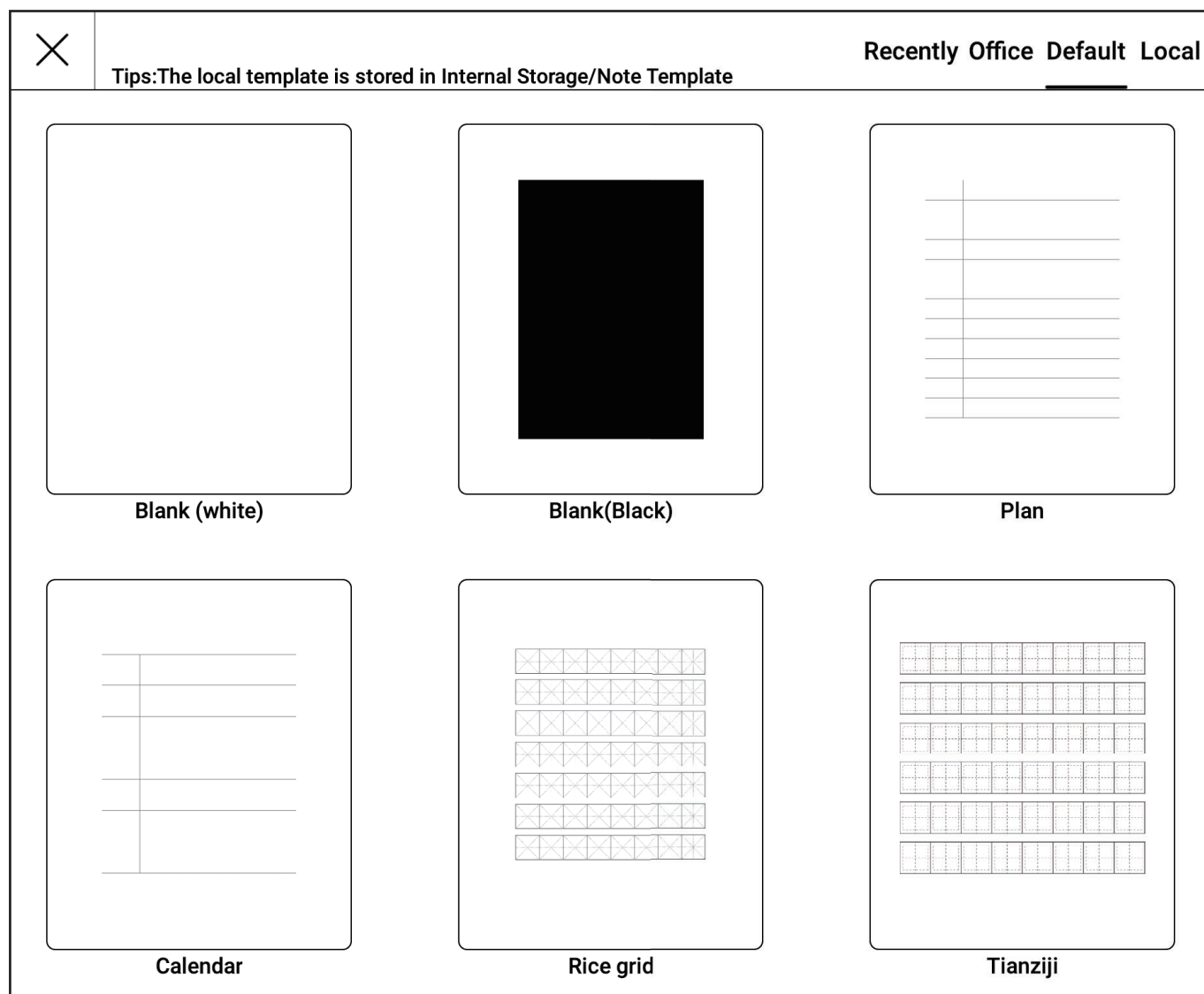

1. Allows for selection of various writing templates for office, study, life, etc. provided by the system.

2. Also supports the import of bmp, jpg, png, pdf format templates, just place the file in the /local storage/ noteTemplate directory.

Managing Meeting Records

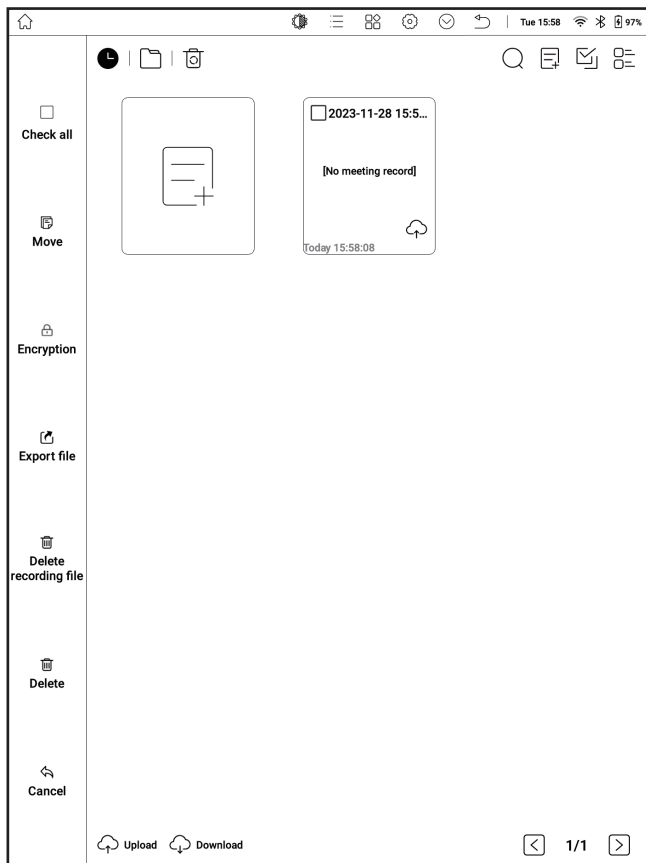

Multi-select

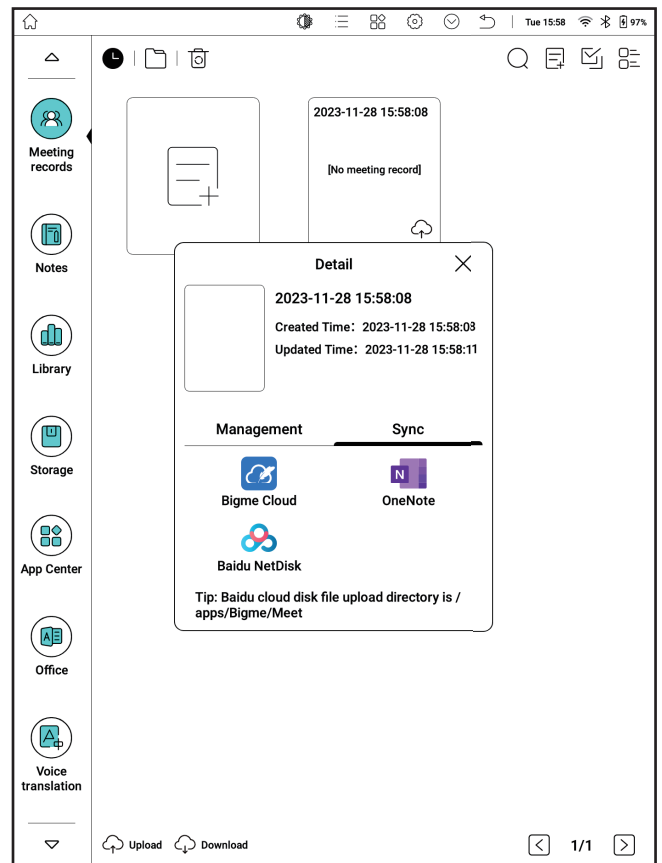

Long Press

1. Click (multi-select) to perform operations such as selecting all, moving, encrypting, exporting files, deleting recording files, and deleting the meeting record documents.

2. Long press the meeting record document to rename, delete, move, encrypt notes, and synchronize to Onenote notes, Bigme Cloud, Baidu Cloud Disk, etc.

8. Notes

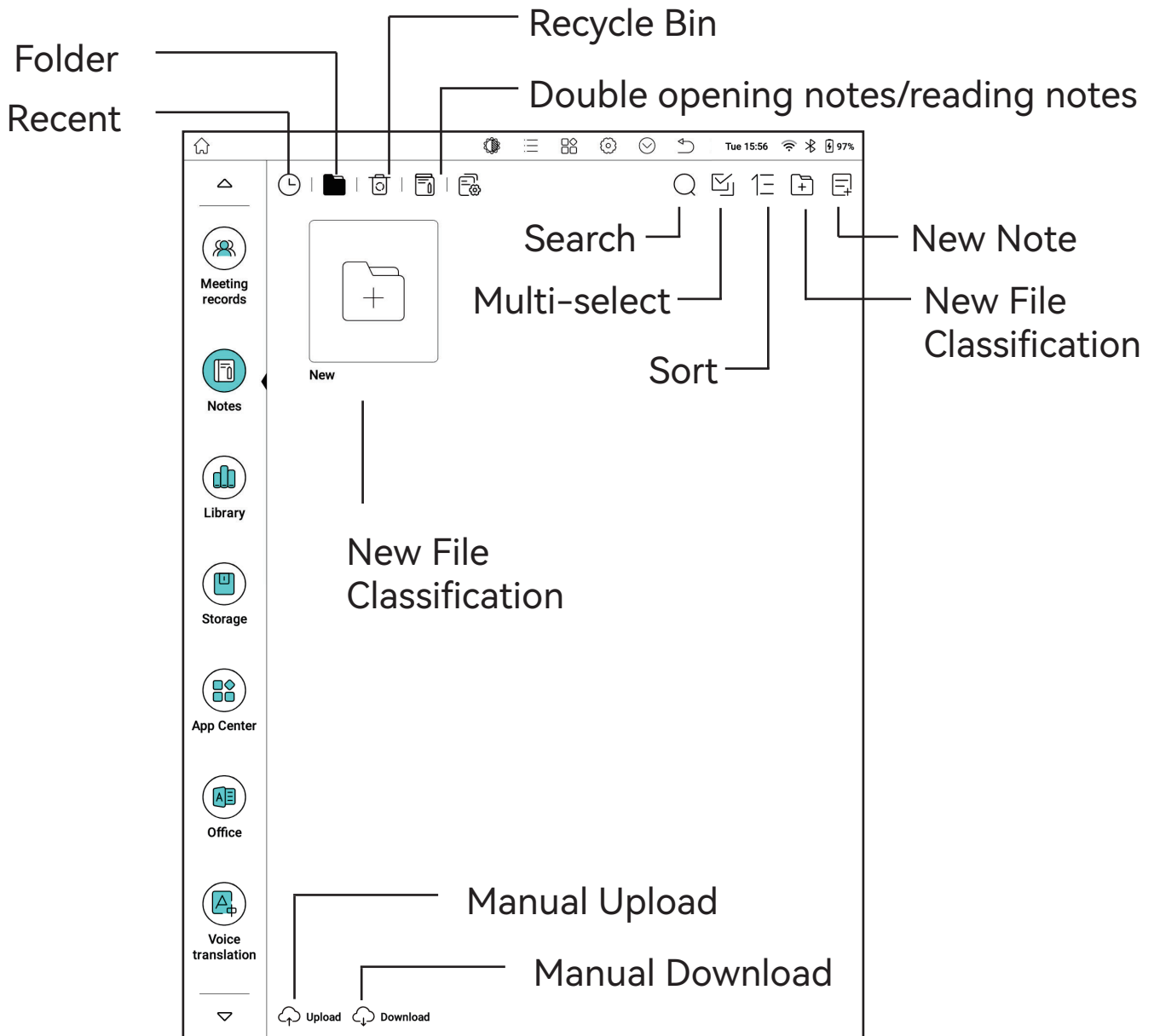

Menu Bar

Brush2

Type: Pen, Pencil, **Brush**, BallPen, HighLight

Color: Black(#000000), [Color Swatches]

Line width: [Slider set to 2]

- Pen
- Pencil
- Brush
- BallPen
- Pencil
- Erase
- Insert
- Page
- Template
- Shapes
- Photo
- Text
- Page
- Crop

Writing area

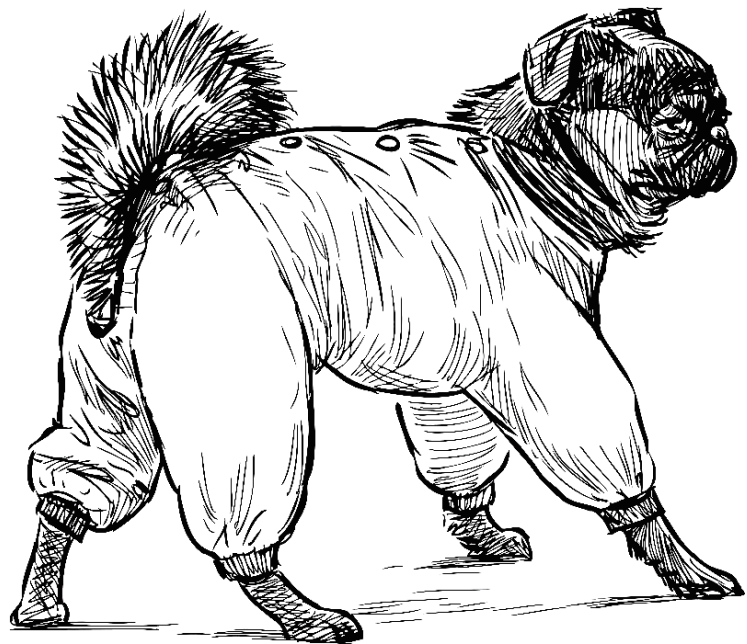

Creating New Notes – Basic Menu Bar

1. Save and Exit: You can save or delete meeting record notes
2. Title: You can customize the note name
3. Toolbar: Allows for the display or hiding of the floating toolbar; long press on the floating toolbar to move its position.
6. Sharing and Exporting: Allows for sharing of meeting records to others through QR code, verification code, etc. Also allows for exporting of meeting records as PDF files or TXT files.
7. More: file transcription, OCR, Encrypt, Rotation, Enable Sliding Page Turning, etc.
8. Undo: Returns to the previous operation.
9. Redo: Proceeds to the next operation.
10. Previous Page: Turns to the previous page.
11. Next Page: Turns to the next page or adds a new page.

Creating New Notes – Floating Toolbar and Handwriting Area

1. Toolbar: Allows for the display or hiding of the toolbar window.
2. Clicking on the pen type in the floating window, such as [Highlighter], allows for adjustment of the color and thickness of the pen stroke.
3. Eraser: Allows for selection of erasure methods such as track erasure, range erasure, or full erasure.
4. Insert: text, pictures, pages, templates, etc. can be inserted
5. Delete this page: Delete the page that currently being edited

Managing Notes

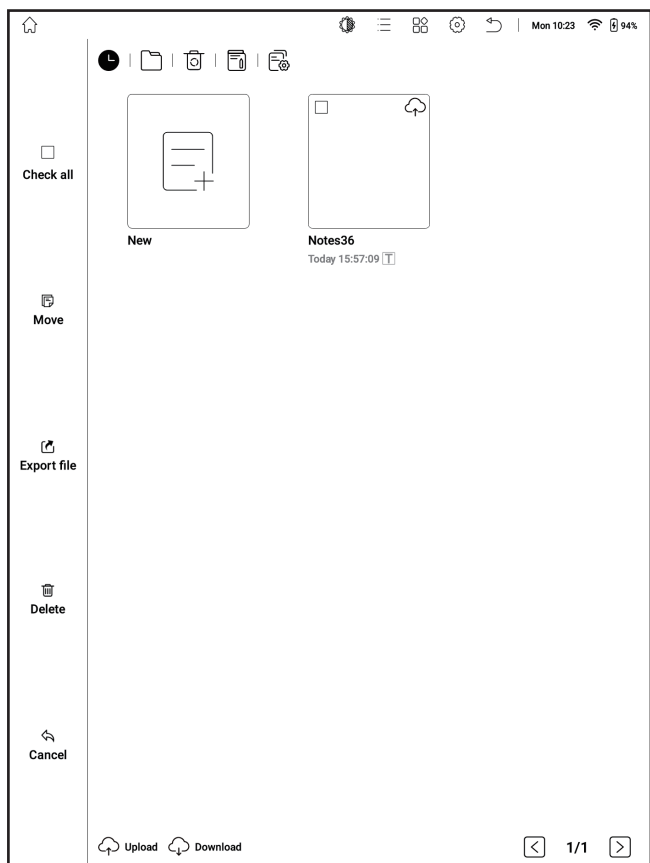

Multi-select

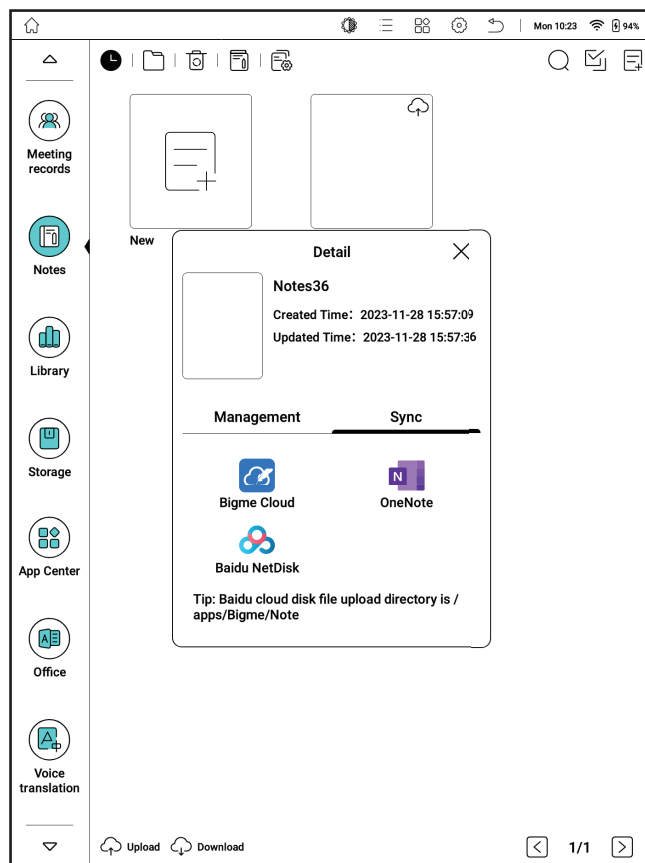

Long Press

1. Click (multi-select), you can select all, move, export files, and delete the documents.

2. Long press the document that on Notes, you can set it as a screen saver image, move, rename, delete, encrypt notes, and sync to Onenote notes, Bigme Cloud, Baidu Cloud Disk, etc.

9. Bookshelf

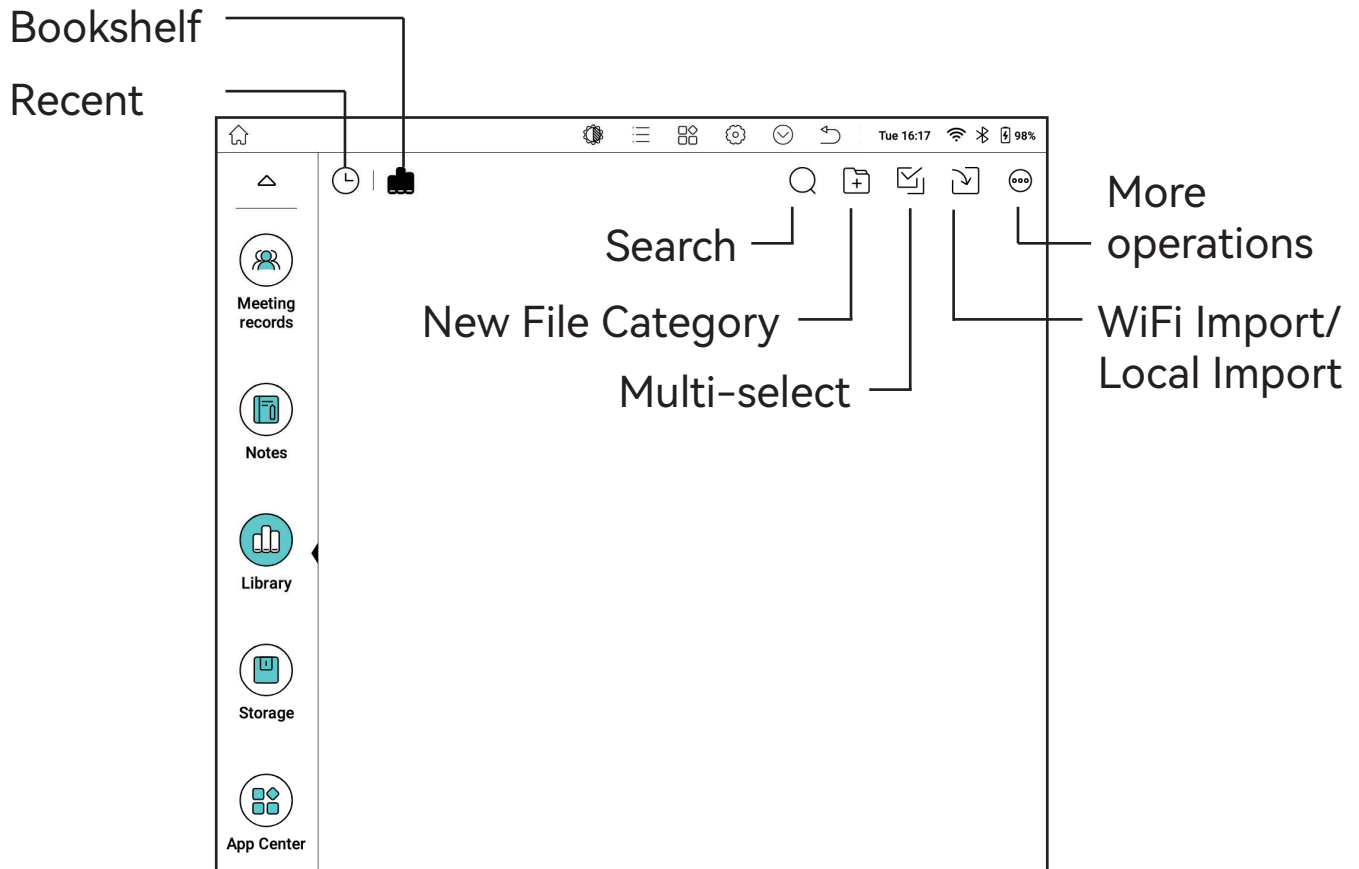

Additional Operations:

1. You can reorder books by filename, creation time, and update time
2. You can freely switch the page display style between grid and list

Manage Books

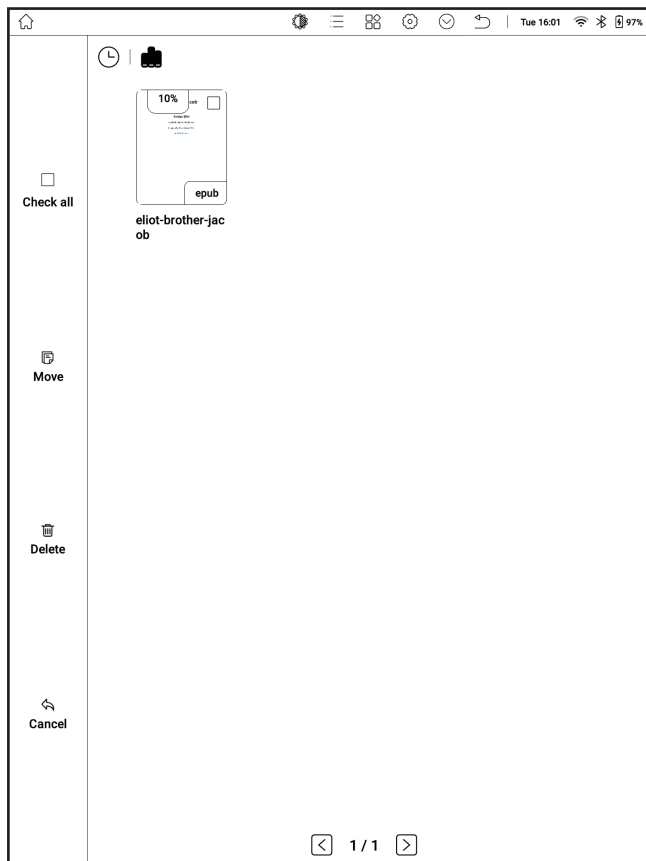

Multiple Selection

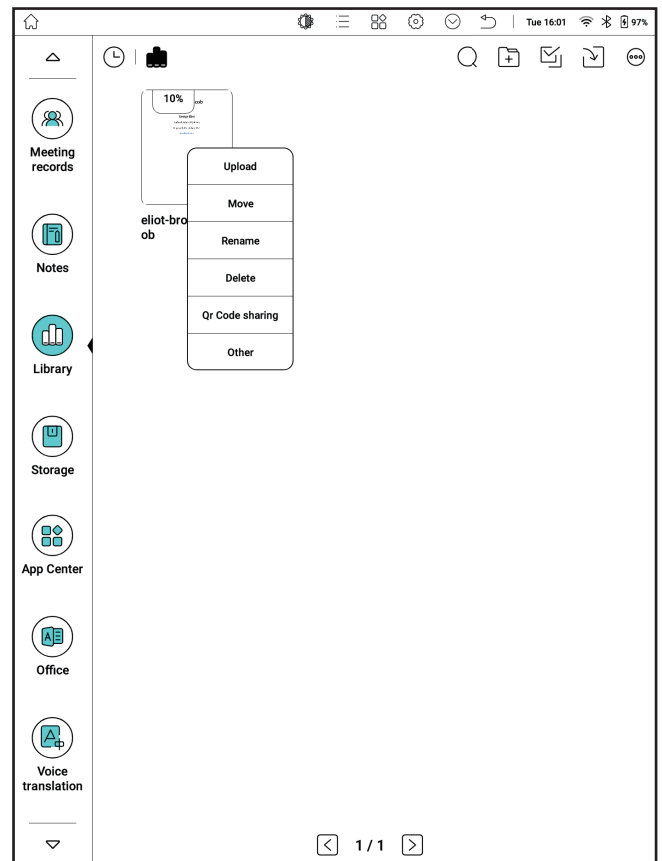

Long Press

1. Click on "Multiple Selection" to select all and delete book documents
2. Long press on the book document to upload, move, rename, delete, share QR code, and other sharing operations

Reading



1. Return: Exit reading
2. Touch: Click to turn on or off touch
3. Handwriting Pen: Click to show or hide the type of pen and eraser window; adjust the color and thickness of the pen stroke; or choose an eraser to erase traces, erase range, erase all, etc.
4. Search: Enter keywords to search
5. Settings: Refresh mode and basic settings
6. Bookmark: Bookmark the current reading page

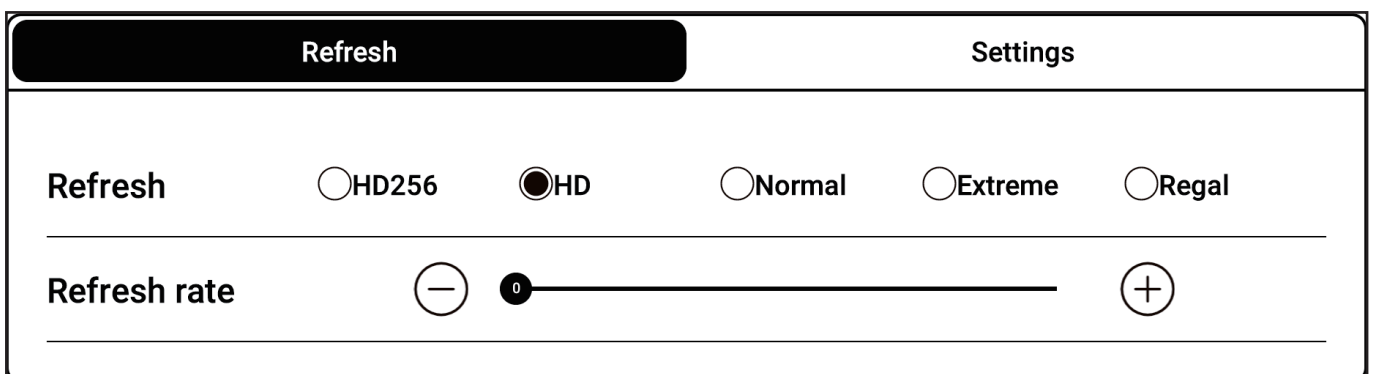

Refresh Mode



1. Choose from HD 256, HD, Normal, Speed, and Regal refresh modes



2. Adjust the full refresh frequency

settings

Refresh	Settings
Export path Export bookmark, annotate, and handwriting catalogue	/storage/emulated/0/exportBooks/
Long tap to enter Menu Long press to display menu	<input checked="" type="radio"/> Menu <input type="radio"/> Dictionary
Dictionary setting Click Dictionary to replace the old Dictionary	Click and select dictionary
Bookmark Start bookmark	<input type="checkbox"/> OFF
Download Cloud tag content Log in and enable Wi-Fi cloud read and write marks (notes, bookmarks, handwriting) to sync the current book	
mode selection Choose your preferences	<input type="radio"/> Left To Right <input checked="" type="radio"/> Right To Left
Reading progress style	<input type="radio"/> Page number <input checked="" type="radio"/> Percentage
Data synchronization	

1. View export path
2. Modify long press menu: Choose menu or dictionary
3. Dictionary settings: Customize the dictionary
4. Convenient bookmark: Turn on or off
5. Download cloud read-write mark content: Download bookmarks, annotations, handwriting, etc. uploaded to the cloud to the local machine
6. Mode selection: Freely switch between left-hand or right-hand mode according to your own usage habits
7. Style of Reading Progress: Page number display or percentage display can be selected
8. Data Synchronization: embedded data and old data of documents can be imported

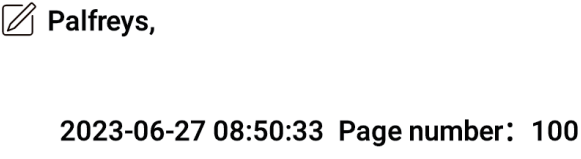
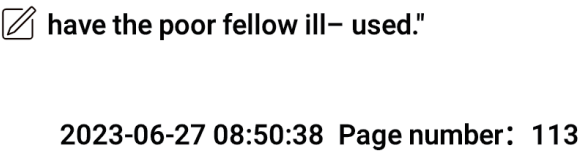
Table of Contents

	<input type="checkbox"/>	ling, with every
	<input type="checkbox"/>	nd, except the d the Bath buns
		them.
		

08:50  100%





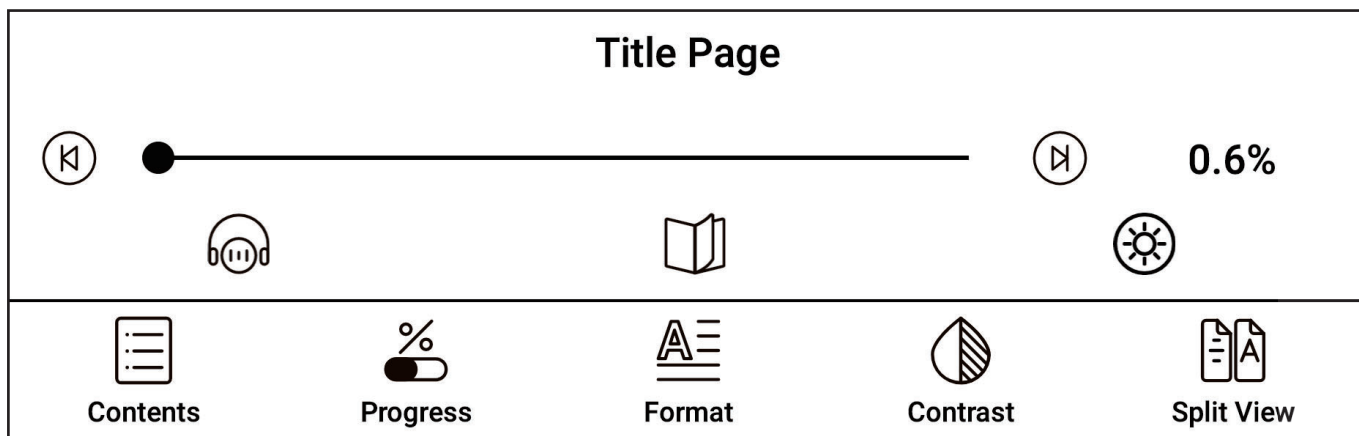







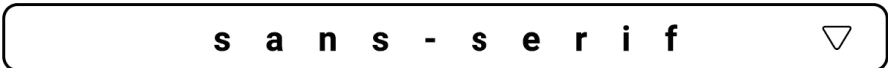

1. View the book's table of contents
2. View the book reading's bookmark notes
3. View the book reading's annotation notes
4. View the book reading's handwritten notes
5. You can sort, delete, upload to the cloud, export, and select all notes
6. You can display the window in full screen

Progress











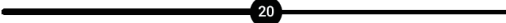







1. Previous Chapter: Go back to the previous chapter of the book
2. Next Chapter: Go to the next chapter of the book
3. Listen to the book: Set a timer, adjust the volume and playback speed
4. Automatic page turning: Set a timer, adjust the automatic page turning interval and adjust the total number of automatic page turns
5. Night/Day Mode: Freely switch between night or day mode according to your own reading habits













Typesetting

Fonts	Spacing	Others		
Font Size	 			
Embolden	 			
Fonts				
More	 			
 Contents	 Progress	 Format	 Contrast	 Split View

1. Font: Adjust the text size, font thickness, and change the font; change the encoding, turn on or off two-finger zoom and one-click restore default settings; support custom fonts, put ttf format fonts in the xReader/fonts directory











Fonts	Spacing		Others	
LineSpacing				
SegmentSpacing				
Left/right Margin				
Top/Bottom Margin				
				
Contents	Progress	Format	Contrast	Split View

2. Style: Adjust the line spacing, paragraph spacing, left and right spacing, and top and bottom spacing of the article

Fonts	Spacing			Others	
Chinese	原		简		繁
Page Display					
Rotating screen					
					
Contents	Progress	Format	Contrast	Split View	

3. Other: Convert between simplified, traditional and default fonts; set double-page or single-page reading; adjust the screen orientation









Contrast

Text contrast					
Picture contrast					
					
Contents	Progress	Format	Contrast	Split View	

1. Text Contrast: Adjust the clarity of the text

2. Image Contrast: Adjust the clarity of the image

Double Open

 Current Doc & only	 Current Doc & Another Doc	 Doc & Notepad	 Doc & Translate	
 Contents	 Progress	 Format	 Contrast	 Split View

1. Double open the current document: Double open the currently reading document for split-screen browsing
2. Double open different documents: Double open split screen, open two different documents for reading at the same time
3. Double open notes: Double open split screen, make records while browsing the document
4. Double open translation: Double open split screen, intelligently translate the document content while browsing the document

Long Press - Word Selection Menu

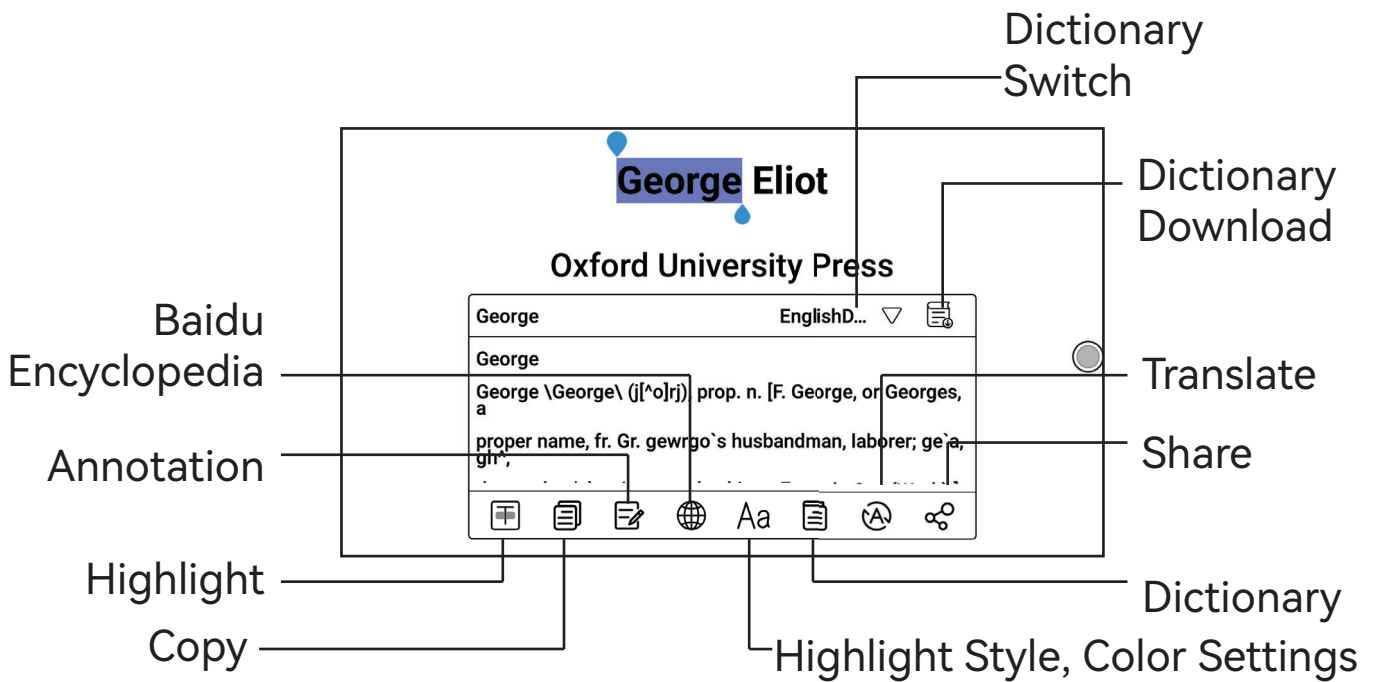

1. You can call the dictionary to query the text
2. Support multiple dictionary switching, you can select the required dictionary document from the drop-down menu
3. This function requires dictionary document support. If no dictionary document is loaded, word queries cannot be made
4. Click on a blank space to exit the dictionary query

Long Press – Word Selection Menu

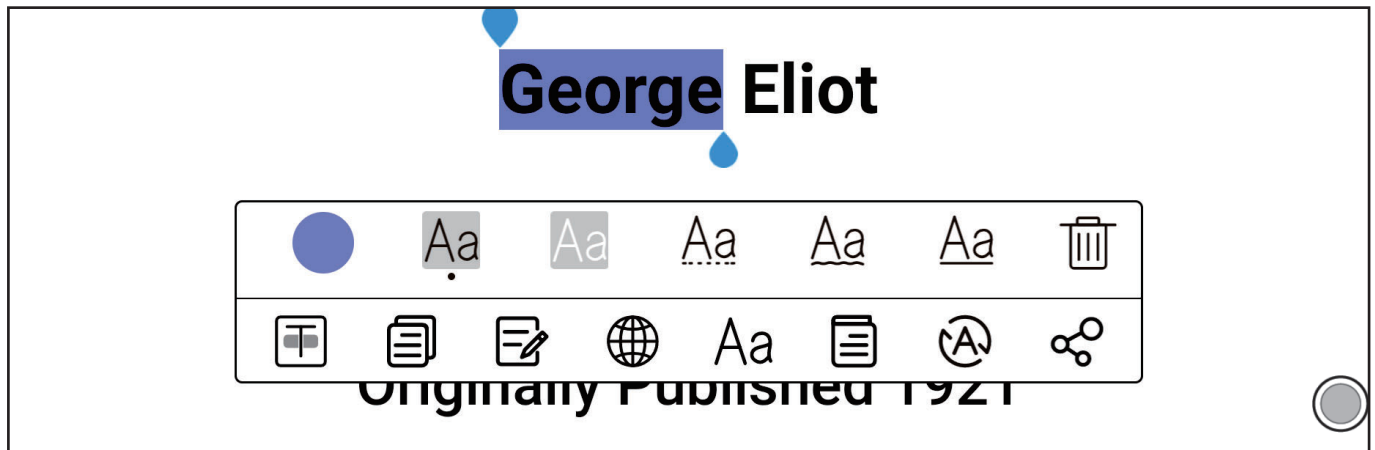

1. Highlight Style Color Setting: Use the highlighter to long press the word and select the icon [Aa] in the pop-up menu. You can set the highlight style such as highlight, underline, wavy line, and also set the highlight color.

2. Set Highlight: Use the highlighter to long press the word and select the icon [T] in the pop-up menu to highlight the selected content

3. Delete Highlight: Click on the highlighted content with your hand and select the icon [Aa > 🗑️] in the pop-up menu to delete the highlight

4. Click outside the word selection menu to directly exit the word selection menu

Progress - PDF

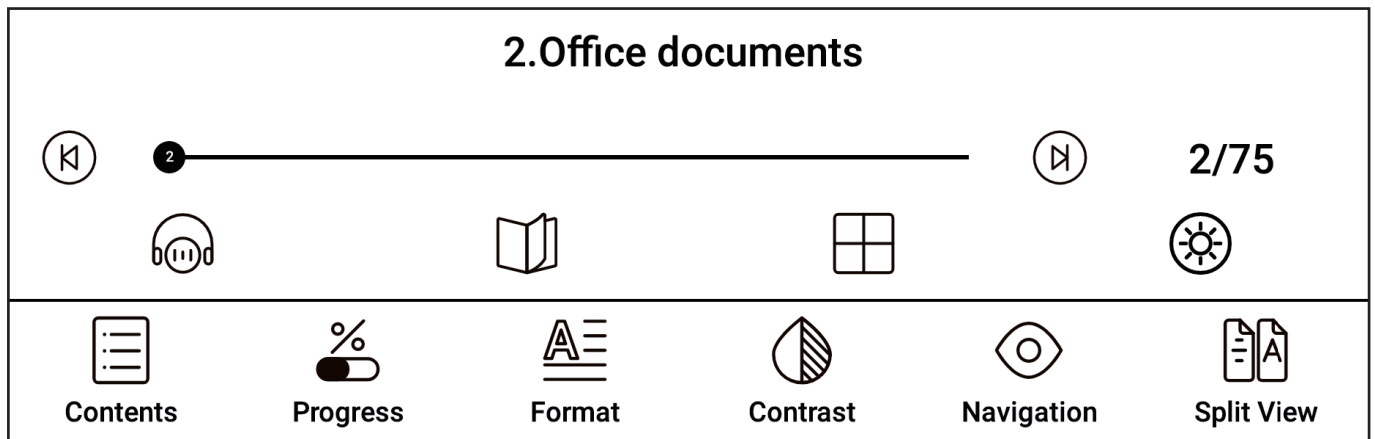

1. Previous Chapter: Go back to the previous chapter of the book

2. Next Chapter: Go to the next chapter of the book

























3. Listen to the book: Set a timer, adjust the volume and playback speed

4. Automatic page turning: Set a timer, adjust the automatic page turning interval and adjust the total number of automatic page turns

5. Quick Preview: Display multiple pages of documents at the same time for quick preview, you can set single page, 4 grid, 9grid, and 16 grid display

6. Night/Day Mode: Freely switch between night or day mode according to your own reading habits

Typesetting - PDF

Page Display					
Zoom					
Crop					
Rotation					
Leaving Blank Space					
					
Contents	Progress	Format	Contrast	Navigation	Split View

1. Pagination: Choose the left or right side as the starting page
2. Zoom: Click to gradually enlarge or shrink; turn on or off two-finger zoom
3. Crop: You can crop corners, top and bottom, left and right, all around, and custom cropping
4. Rotate: You can set the rotation direction to default portrait, rotate 90°, rotate 180°, rotate 270° or rotate with the system direction
5. Margin: When choosing left and right cropping, it is the default size of the blank area retained when cropping, which is a manual modification of the cropping edge

Contrast - PDF

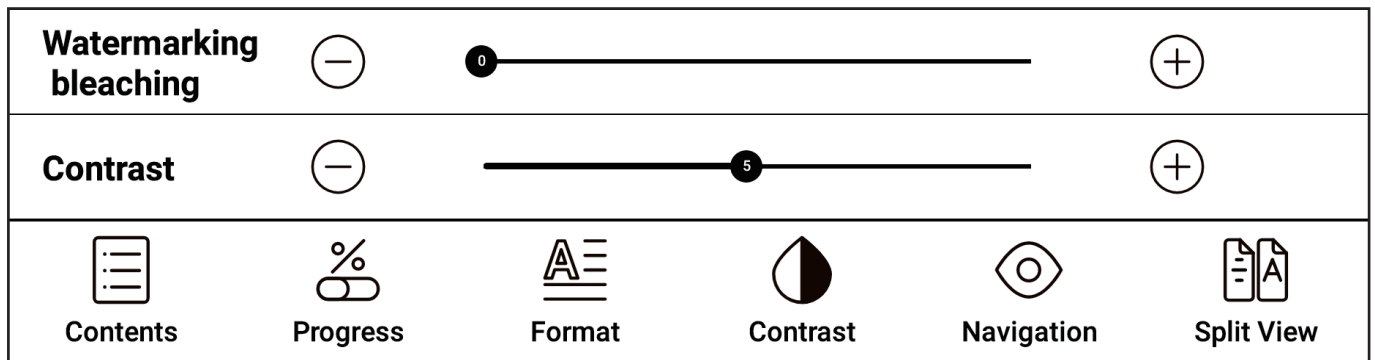

1. Watermark Bleaching: You can bleach and remove the watermark on the page
2. Contrast: Adjust the clarity of the document content

Browse - PDF

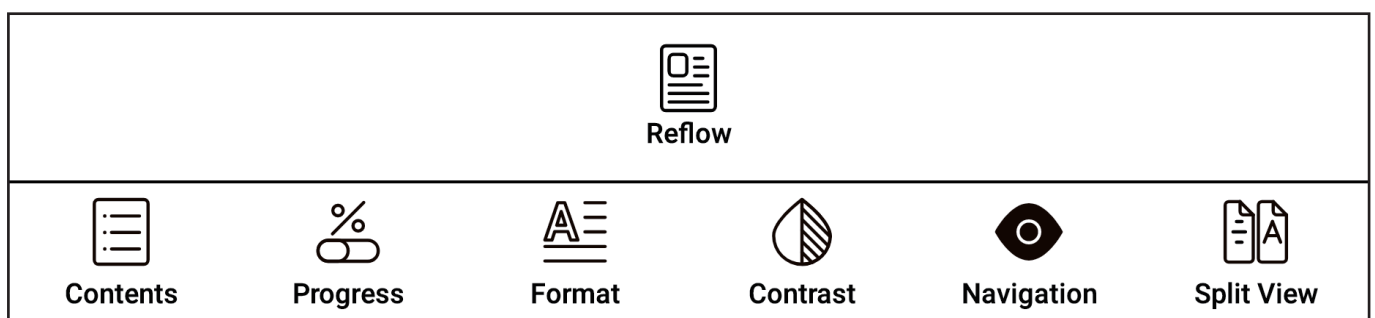

Reflow: Repaginate the document content

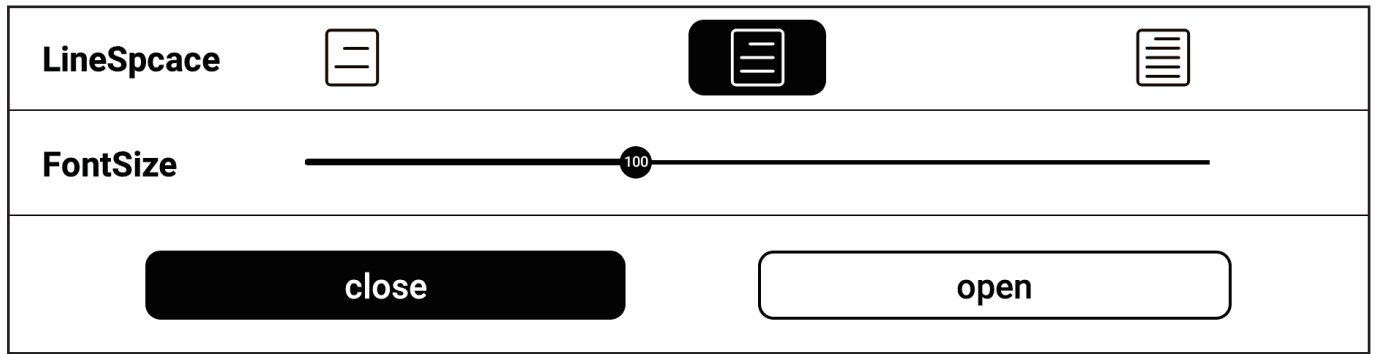

1. Line Spacing Format: Adjust the line spacing of the document's text content.

2. Font Size: Adjust the size of the document's text.

10. Office Documents

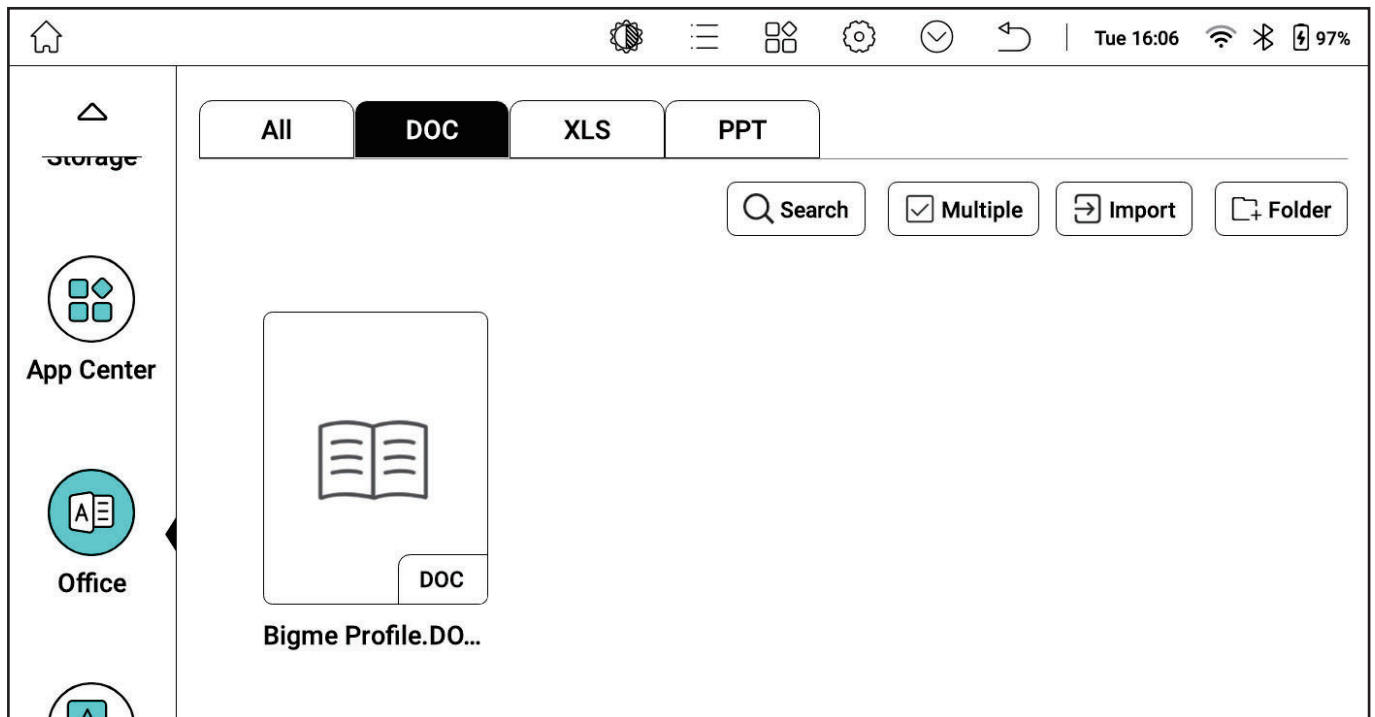

1. All: Display all Office documents.
2. Documents: Display doc, docx files.
3. Tables: Display xls,xlsx files.
4. Presentations: Display ppt, pptx files.
5. Search: Enter keywords to find files.
6. Multi-select: Select multiple files for actions like moving and deleting.

7. Import: Import from /internal storage/Office subfolders or /internal storage/Download folder.

8. Folder: Create new folders for file categorization.



9. Long press file: Upload, delete, rename, move, share via QR code and other sharing options (like Bluetooth, email).



11.ChatGPT

Chat

<

Chat Composition AI Draw 

2023-11-28 16:22:28  Conversation  New

 Help me write a daily work report, focusing on UI design work content 



 Subject: Daily Work Report - UI Design

Date: [Date]

Dear [Supervisor/Team],

I am writing to provide a detailed summary of the UI design work I have accomplished today. Please find below a breakdown of the tasks I have completed:

- 1. User Interface Prototyping:**
 - Created wireframes and prototypes for the new product feature in collaboration with the development team.
 - Incorporated feedback from stakeholders to fine-tune the user interface designs.
 - Explored various design concepts and layouts to ensure an intuitive and visually appealing interface.
- 2. Graphic Design:**
 - Developed high-fidelity mockups for upcoming website enhancements, including landing pages and interactive elements.
 - Collaborated with the marketing team to design engaging visual assets for social media campaigns, ensuring brand consistency.
- 3. Interaction Design:**
 - Conducted thorough research on user behaviors and preferences to inform optimal interaction patterns.
 - Implemented interactive elements, such as buttons, menus, tooltips, and animations, for enhanced user experience.
 - Worked closely with the development team to ensure seamless implementation of interactions within the interface.
- 4. Visual Styling:**
 - Defined a comprehensive style guide for UI components, including typography choices, color schemes, and iconography.
 - Maintained consistency across all screens by adhering to established design standards throughout various product modules.
- 5. User Testing and Feedback Integration:**
 - Conducted usability testing sessions with a group of selected users to gather feedback on specific UI features.
 - Analyzed feedback data and implemented necessary design iterations based on user insights garnered from these sessions.

 What would you like to chat with me? 

1. Avatar: View ChatGPT's account and profile.
2. Conversations: View past chat history.
3. New: Create a new chat with a custom title.
4. Dialogue Box: Voice input, keyboard input, or handwriting input.

Composition

< Chat **Composition** AI Draw 

Export

Composition Theme

Sky Submit

Outline

1. The Majesty of the Sky: Exploring its Wonders and Marvels
2. The Significance of the Sky in Human Culture and Religion
3. Protecting the Skies: Environmental Concerns and Efforts for a Sustainable Future

AI Generate

1. Topic: Enter the title of the article you want to write.
2. Outline: AI generates a creative outline, which can be modified.
3. AI Generation: AI generates different content paragraphs.
4. Export: Export as TXT or PDF document.

AI Draw

< Chat Composition **AI Draw** 

Drawing description

I am an AI painter, I can generate pictures based on your description (it is recommended to use multiple specific keywords and phrases to describe)

0/300 

You can describe the image features that need to be generated like this

Sweet, long hair, eyes Natural scenery, mo... cute, magical, fantasy...

Lions, flowers, exqui... Fantasy adventure... The fish tank world, ...

Paper cutting craft, ...

Start creation

My creation 



< 1 / 1 >

Painting Description: Enter keywords and adjectives related to the picture you want. The more detailed the description, the more accurate the picture will be.

12. Image Browser

Set Screensaver/Cancel Screensaver

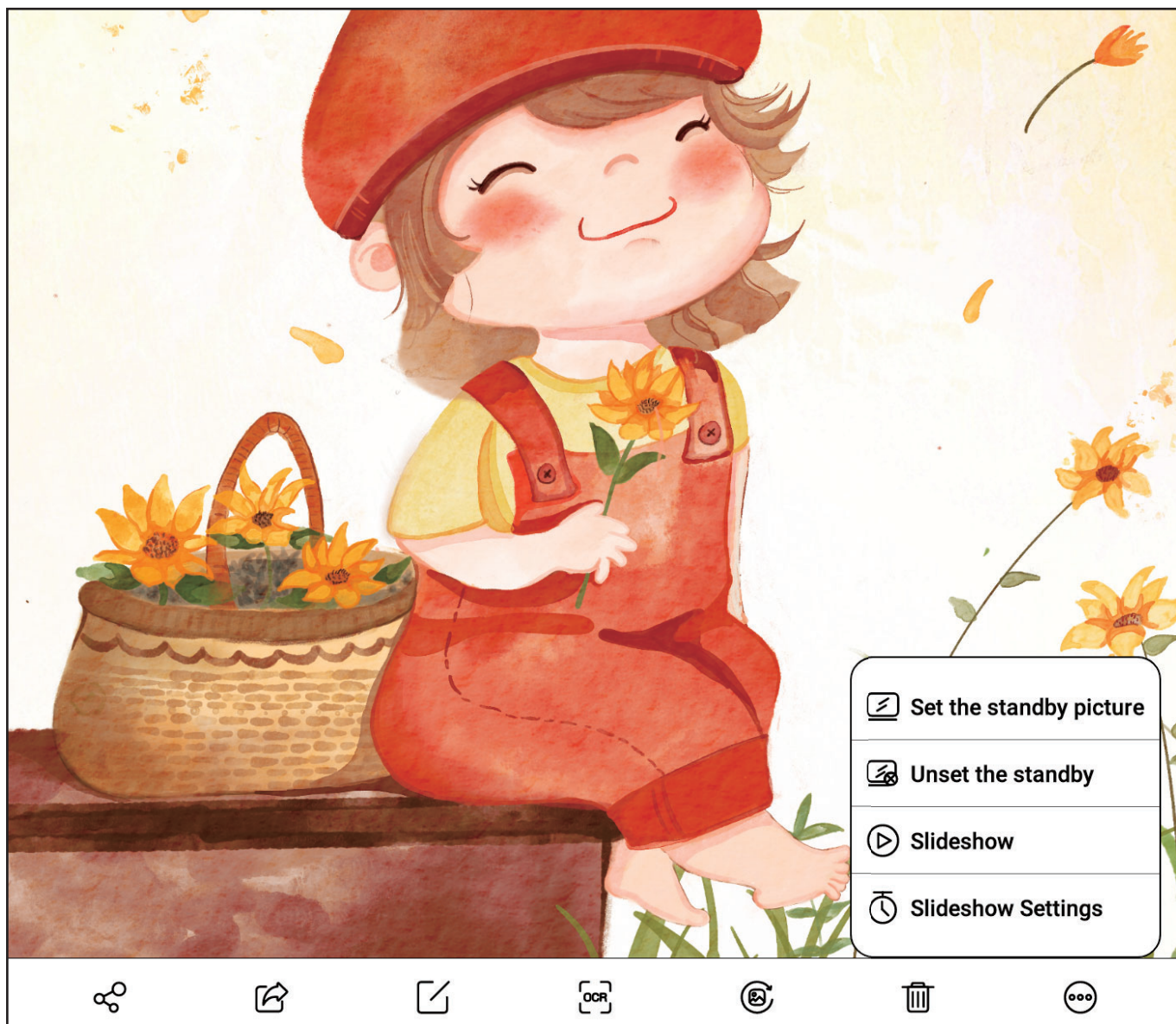

Click on “More” to set/cancel the screensaver for the current image

Export as PDF

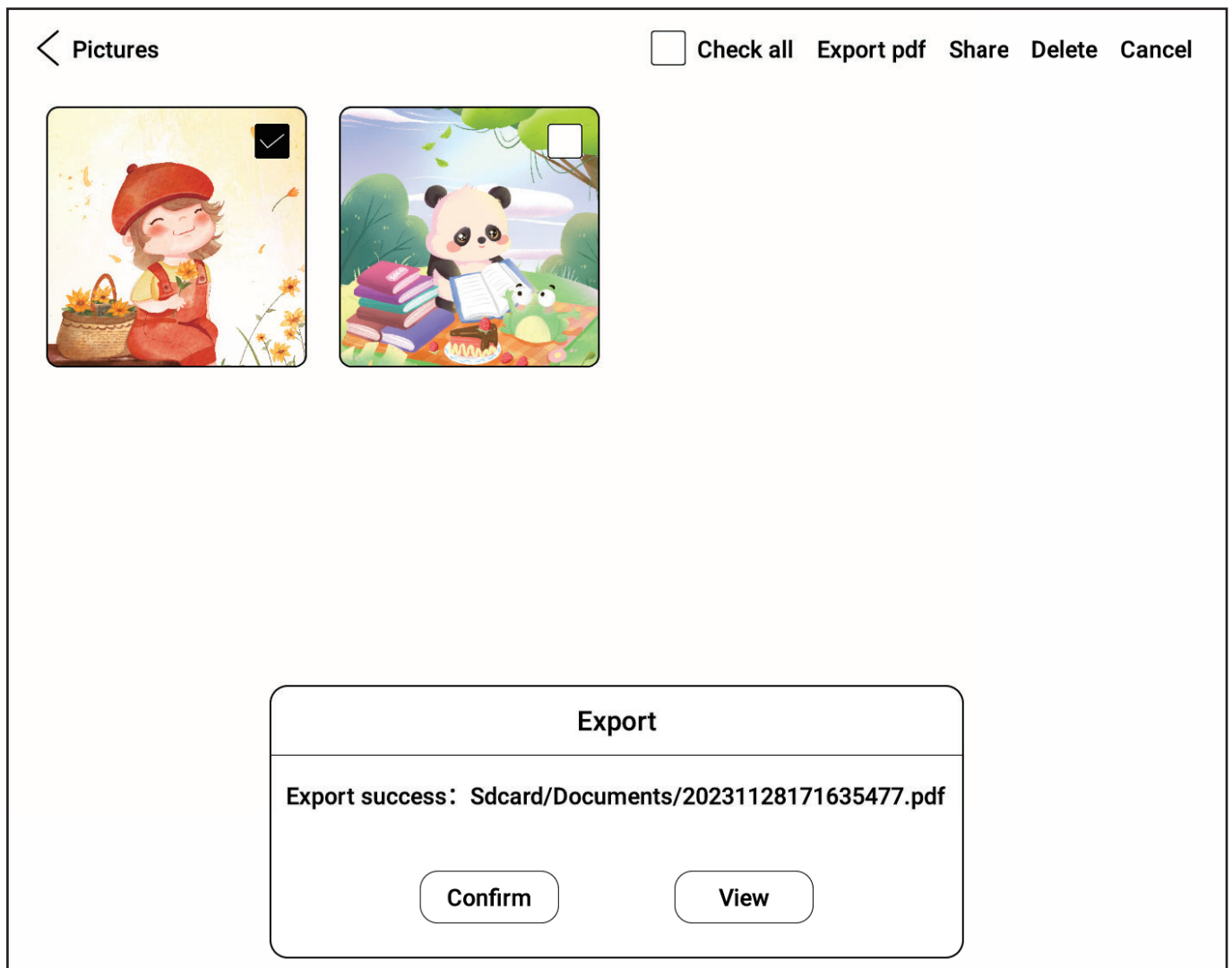

1. Click on "Select", choose multiple files.
2. Click on "Export" to PDF.
3. Export path is: Internal storage/Documents/.

Image Editing



Click on "Edit" to make changes to the image, crop, insert text, etc.

OCR Recognition

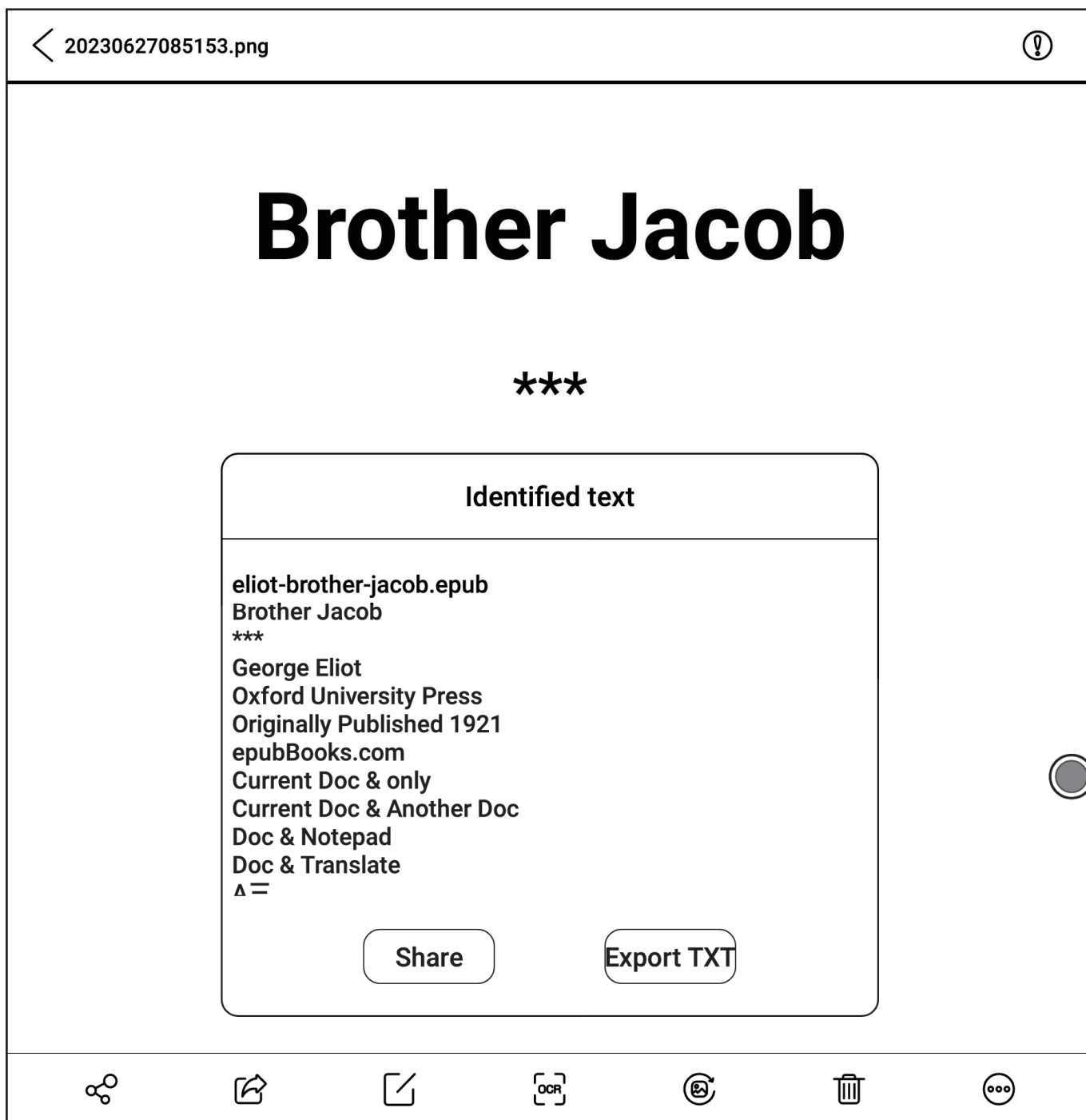

1. Click on "OCR" to recognize text in the image.
2. Share or export the recognized results as a TXT file.
3. Path is: Internal storage/Pictures/OCR/.

13. App Center

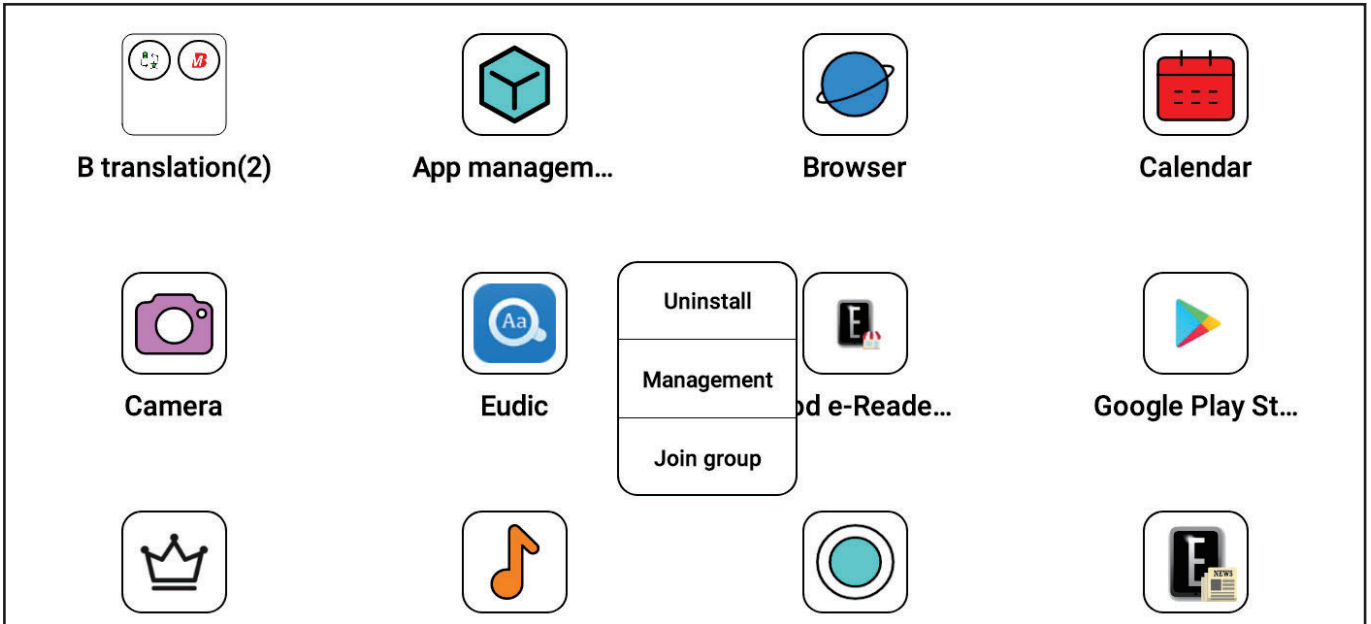

1. Long press app: Uninstall, manage (open, set app permissions, force stop, etc.), add to group.

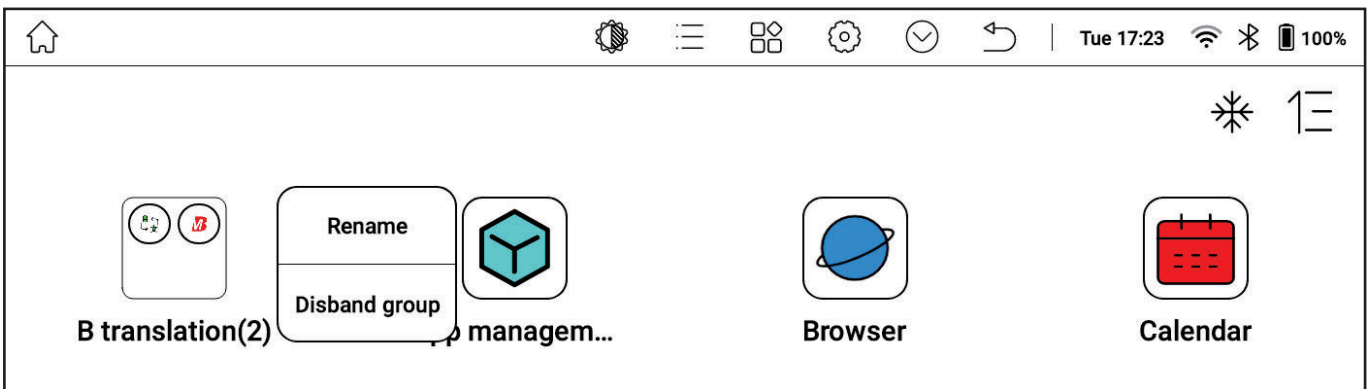

2. Long press app group: Rename, disband group.