

HOW TO REGISTER

Download the TLock app from Google Play or App Store. Search "TLock."

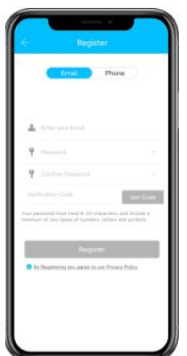

STEP 1
Tap on register to get started!



STEP 2
Fill out this and then tap "Get Code". You will be sent a verification code to verify your account! Once, you receive it, tap on "Register"

Note: The TLock app is needed to use this lock. If this lock was professionally installed (or installed by someone other than the homeowner), make sure this step is performed by the homeowner.

PAIRING YOUR LOCK



STEP 1
Tap on the three horizontal lines.



STEP 2
Tap on "+ Add Lock"



STEP 3
Tap on "Next"



STEP 4
Tap on the blue plus sign.

Note: You may need to tap on lock keypad.

LOCK PAGE OVERVIEW

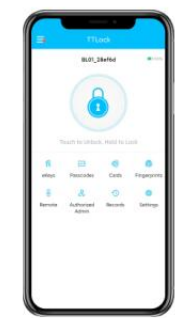

- Unlock/Lock**
Unlock/Lock using phone's bluetooth
- eKeys**
Set up and send eKeys
- Passcodes**
Set up and generate 6 different types of passcodes
- Cards/Fobs**
Set up your fobs here
- Records**
View entry times, attempts and methods
- Fingerprints**
Set up fingerprints
- Settings**
View and modify settings
- Remote**
Wireless Key Fob Page
- Authorized Admin**
Create and edit admins

APP UNLOCK/LOCK



To unlock the lock, tap this icon once.
To lock the lock, press and hold on this icon.

Note: This will only work while you are within bluetooth range of the lock. Refer to Wifi Gateway Guide page for remote unlock/lock information.

PASSCODES

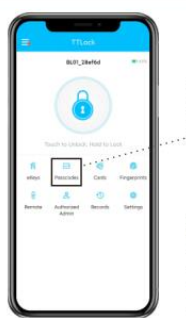

STEP 1
To access the passcode menu, tap on "Generate Passcode". This will take you to the passcode page.

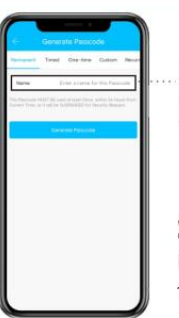

STEP 2
Enter a name for this Passcode.

Here is a breakdown of the 6 different code types for different durations.

Permanent	Lasts permanently	Erase	Erases all codes on lock
Timed	Lasts between selected hours	Custom	Choose your own digits such as 654321 (permanent or timed)
One-time	Lasts for one use	Recurring	Lasts during scheduled hours weekly

PASSCODES



Best Practice:
When inputting the passcode, use "Code + #".

Pay attention to this text when generating a code. You may experience issues if these instructions are not followed.

Note: To generate custom codes, you will need to be within bluetooth range of the lock unless a Wifi Gateway is connected.



Within this page, you can
1, Edit a passcode's number, validity, and name.
2, Delete code and view records.



Note: The above can only be done within bluetooth range unless a Wifi Gateway is connected.

IC CARD/FOBS

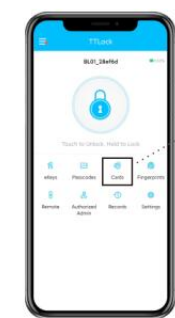

1. Tap on "Cards"
2. Tap on "Add Card"
3. Choose the validity period of the lock.
4. Once the lock says "Please swipe your card", place the fob against 5 on the keypad.
5. If you hear "input successful", the fob can be used to unlock your lock.

To add a fob to your lock. Follow these steps.

FINGERPRINTS To add a fingerprint follow these instructions:

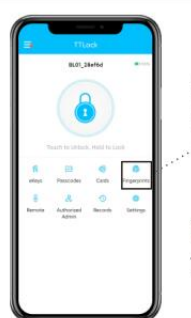

STEP 1
Tap on Fingerprints.



STEP 2
Tap on "Add Fingerprint"

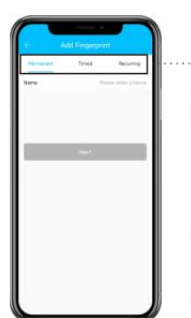

STEP 3
Select Fingerprint type depending on when you would like it to be valid.

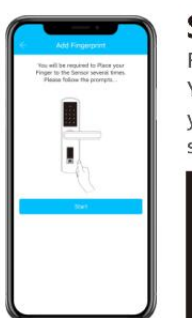

STEP 4
Follow instructions on app. You will be asked to place your finger on the sensor 4 times.

Experiencing issues with fingerprint recognition?

- Ensure the sensor surface is clean.
- Try a different finger.
- Ensure your finger is moist enough.
- Take out batteries for one minute and place back in.

eKEYS



STEP 1

eKeys work by sharing app access of your lock with another TLock account. eKey recipients will be able to use their phone to unlock/lock the lock.

Best Practices:
It is strongly recommended that the recipient first register for an account using the TLock app.

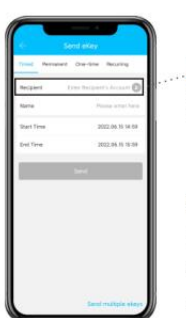

STEP 2

Enter recipient's username. It will be the phone number or email address used during registration. eKeys do not require wifi or bluetooth to be sent or revoked.

二维码

AUTHORIZED ADMIN



STEP 1

Authorized Admins are similar to eKeys; however, an authorized admin can do the following:
1. Unlock/lock via the app.
2. Generate, Edit, Delete passcodes, IC cards, fingerprints
3. Adjust settings like passage mode, auto-lock timer, turn on/off the lock sound.



STEP 2

Enter recipient's username. It will be the phone number or email address used during registration.

二维码

PASSAGE MODE & AUTO-LOCK



STEP 1

Auto-lock will automatically lock the lock when it has been opened after 5 second by default. This can be adjusted with Passage Mode and Auto-lock timer. Outlined below is how to adjust these settings related to auto-lock.



STEP 2

Select Passage Mode



STEP 3

Passage Mode disables auto-lock during a set schedule.

LOCK SETTINGS



- Basics
- Remote Unlock
- Lock Sound
- Privacy Lock
- Import from another lock
- Software Update

Here are some settings you should familiarize yourself with.

Under **Basics**, you can view and change information such as Lock Name.

With **Remote Unlock** on and a Wifi Gateway connected, you can remotely unlock/lock your lock.

Lock Sound adjusts the locks sound level.

Import from another lock allows for the transfer of passcodes and fobs from one lock to another.

Delete will remove the lock from your account and clear any settings on the lock. You must be near the lock to do this.

INTEGRATIONS

Our locks work with the following software:



With more to come in the near future.

SCAN ME

Scan this code to find out how to pair the gateway to app

二维码

WIFI GATEWAY

Wifi Gateway bridges any nearby locks to your local wifi allowing for remote control.



With the WIFI Gateway connected.

- Receive unlock notifications wherever you are.
- Remote unlock/lock.
- Check access logs whenever you need them.
- Generate, edit, or delete custom codes for your guests.
- Access the features of the webportal version of our app for free!
- Check battery level remotely.

二维码

FAQ

Q: I entered a code or fingerprint incorrectly too many times and my lock will not accept any new inputs.

A: Unlock the lock once via the app or wait 5 minutes.

Q: How can I manually lock the lock?

A: Press and hold "#" to lock the lock.

Q: The batteries died before I could replace them. What can I do?

A: Use the provided physical keys to open or plug in a powerbank into the slot on the underside of the keypad to power it up to be able to enter and change the batteries.

Q: How do I share access of the lock on 2 different phones?

A: Refer to eKeys or Authorized Admin section on how to do that is.

Not working like it should? Contact us with the following information for quicker resolution.

- Which product you do have?
- Where are you in the setup process?
 - Installing the product.
 - Setting up the app and pairing the product.
 - Already set up app with the product.
- How long have you had our products for?

Here is how you can contact us:
Web: www.olumatsafe.com
E-mail: olumatsafe@gmail.com
WhatsApp: +86 15918484515

二维码

Explore our constantly updating FAQ for Olumat Smart Lock

二维码

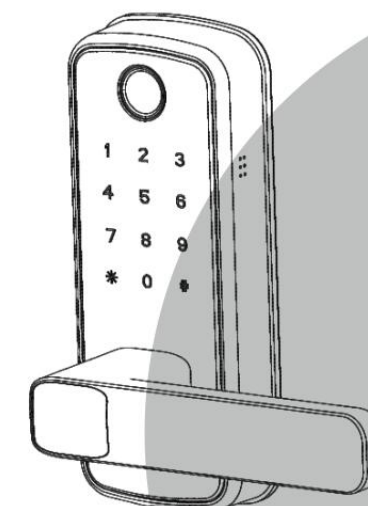

Installation Video

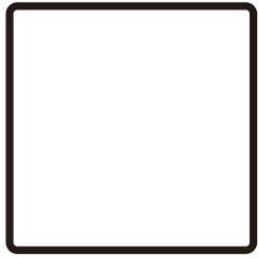

go to <https://www.olumatsafe.com> to watch installation video.

WHAT'S INCLUDED			
Latch and strike	Exterior Assembly	Interior Assembly	Screws
			<p>Step 3</p> <p>Step 4</p> <p>Step 5</p> <p>Backup screws</p>

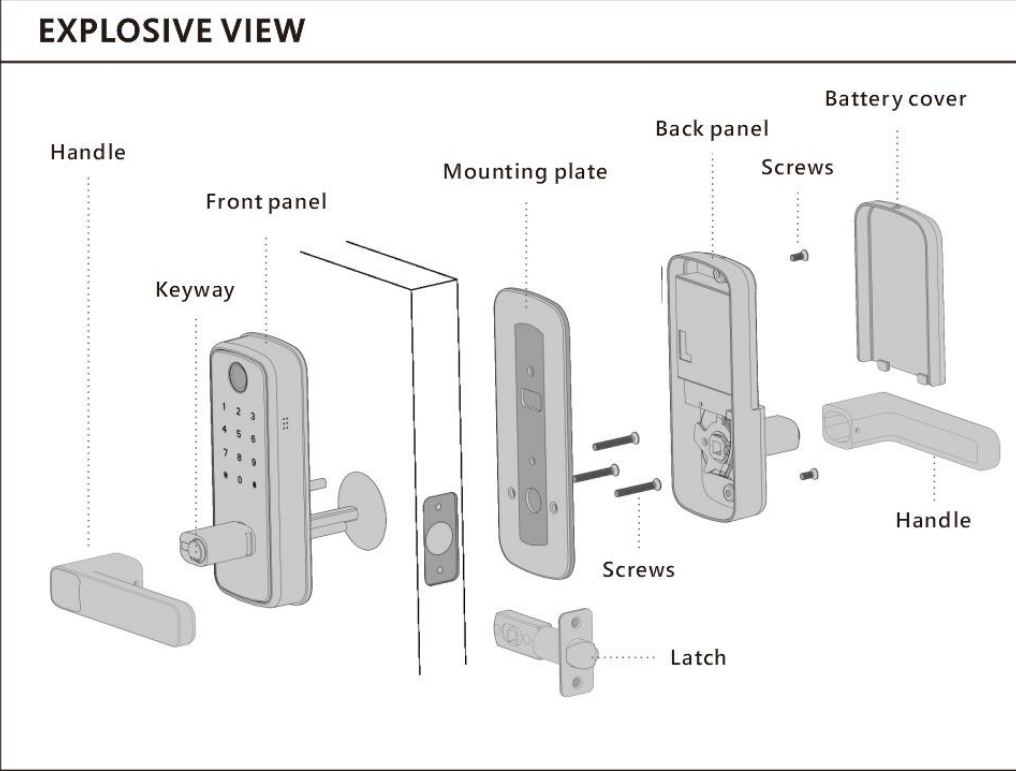
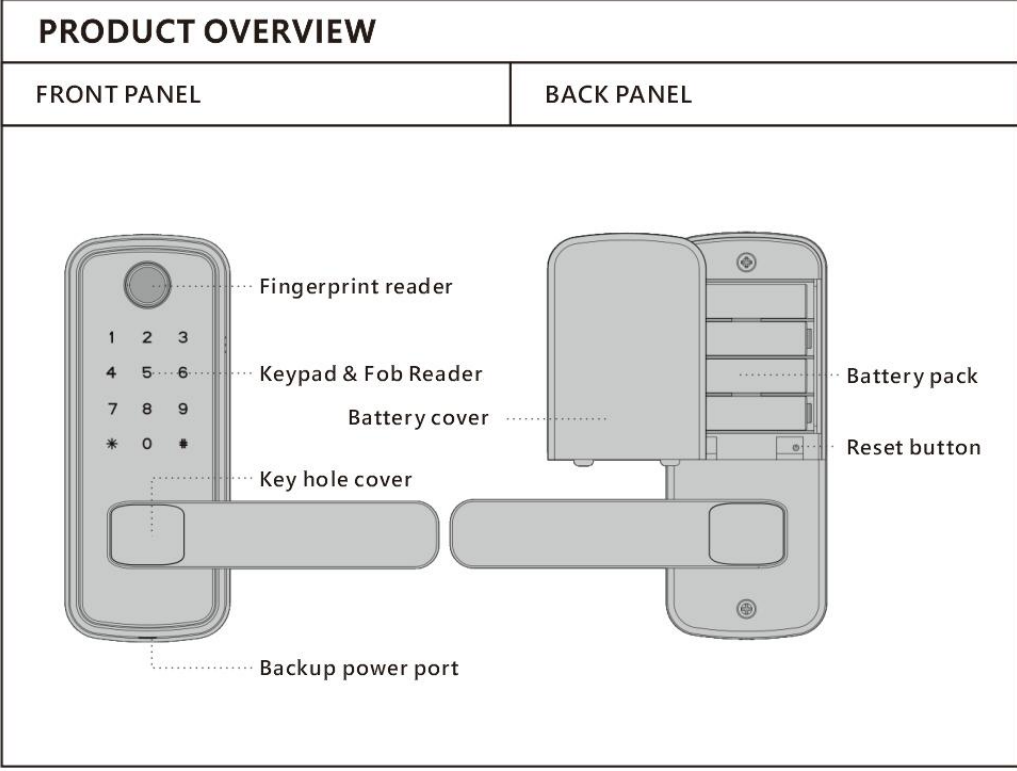

1 Adjust the backset of latch (if needed)

A Hold the latch in front of the door hole, with the latch face flush against the door edge.

B If the latch holes are centered in the door hole, no adjustment is required. Proceed to step 2. If the latch holes are NOT centered, adjust latch. See "Latch Adjustment."

C Latch adjustment (only if needed)

2 Determine the handing of your doors (standing outside the door)

A Right-Handed Door

B Right-Handed Door

A Left-Handed Door

B Left-Handed Door

Note: The square hole must be horizontal.

3 Install latch

A inside

B inside

4 Install front panel and interior mounting plate

A outside

B outside

Note: Choose the screws that will fit the thickness of your door. Check labels on the screw bags.

5 Connect wire connector and install back panel

A inside

Note: The wire connectors can only be connected in one way.

B inside

C inside

D inside

6 Install 4 AA batteries and battery cover

A inside

B inside

C inside

7 Install the door handles

A

B

C

8 Insert the key and test the installation

Install our lock on top (only if needed)

If you have a deadbolt lock on top please move the deadbolt lock to the bottom and install our lock on top to avoid installation issues.

Return and Warranty Information

Return Policy

30 day money back guarantee from date of purchase. Some exceptions may be made with a restocking fee on a case by case basis and buyer may be responsible for return shipping cost. For inquiries regarding this, please contact us at olumatsafe@gmail.com.

Product Warranty

We offer a 1 year free replacement from the date of purchase. To claim your warranty replacement, the first request or inquiry must be made within 1 year of date of purchase. Any requests or inquiries after 1 year from the date of purchase are not eligible for warranty. Olumat reserves the right to deny a replacement request. For inquiries regarding this, please contact us at olumatsafe@gmail.com.

FCC Warning Statement: Changes or modifications to this unit not expressly approved by the party responsible for compliance could void the user's authority to operate the equipment. This equipment has been tested and found to comply with the limits for a Class B digital device, pursuant to Part 15 of the FCC Rules. These limits are designed to provide reasonable protection against harmful interference in a residential installation. This equipment generates, uses and can radiate radio frequency energy and, if not installed and used in accordance with the instructions, may cause harmful interference to radio communications. However, there is no guarantee that interference will not occur in a particular installation. If this equipment does cause harmful interference to radio or television reception, which can be determined by turning the equipment off and on, the user is encouraged to try to correct the interference by one or more of the following measures:

- Reorient or relocate the receiving antenna.
- Increase the separation between the equipment and receiver.
- Connect the equipment into an outlet on a circuit different from that to which the receiver is connected.
- Consult the dealer or an experienced radio/TV technician for help.

This device complies with Part 15 of the FCC Rules. Operation is subject to the following two conditions: (1) this device may not cause harmful interference, and (2) this device must accept any interference received, including interference that may cause undesired operation.

FCC Radiation Exposure Statement

The antennas used for this transmitter must be installed to provide a separation distance of at least 20 cm from all persons and must not be co-located for operating in conjunction with any other antenna or transmitter.

Email us first! We are here to help.

For any technical questions or support, please email us at olumatsafe@gmail.com or visit our website olumatsafe.com to chat with us.

Support is available:
MON-SUN-9 AM to 5 PM PST
www.olumatsafe.com