

TEST REPORT

Client Information:

Applicant: Shenzhen Eversolo Audio Technology Co., Ltd.
Applicant add.: Room 1302, Floor 13, Chentian R&D Building, No. 50, Baotian First Road, Chentian Community, Xixiang Avenue, Baoan District, Shenzhen, China
Manufacturer: Shenzhen Hengshengwei Electronics Co., Ltd.
Manufacturer add.: Room202, Building B, Hengmingzhulindustrial Park, Lingguosuo, Taoyuan Community, Xixiang Street, Baoan District, Shenzhen, China

Product Information:

Product Name: Hi-End Music Streamer
Model No.: DMP-A10
Serial Model: N/A
Brand Name: Eversolo
Test samples.: AiTSZ-240921007-1
FCC ID: 2A8D2-DMP-A10

Applicable standards: FCC CFR Title 47 Part 15 Subpart E Section 15.407

Prepared By:

Guangdong Asia Hongke Test Technology Limited

B1/F, Building 11, Junfeng Industrial Park, Chongqing Road, Heping Community, Fuhai Street, Bao'an District, Shenzhen, Guangdong, China

Tel.: +86 0755-230967639 Fax.: +86 0755-230967639

Date of Receipt: Sept. 28, 2024 Date of Test: Sept 28, 2024 ~ Oct. 13, 2024

Date of Issue: Oct. 13, 2024 Test Result: Pass

This device described above has been tested by Guangdong Asia Hongke Test Technology Limited and the test results show that the equipment under test (EUT) is in compliance with the FCC requirements. And it is applicable only to the tested sample identified in the report.

Note: This report shall not be reproduced except in full, without the written approval of Guangdong Asia Hongke Test Technology Limited, this document may be altered or revised by Guangdong Asia Hongke Test Technology Limited, personal only, and shall be noted in the revision of the document. This test report must not be used by the client to claim product endorsement.

Reviewed by: _____

Leon Yi

Leon.yi

Approved by: _____

Sean She

Sean She



1 Contents

	Page
COVER PAGE	
1 CONTENTS	2
2 TEST SUMMARY	5
2.1 Statement of the Measurement Uncertainty	5
2.2 Measurement Uncertainty	5
3 TEST FACILITY	6
3.1 Deviation from standard	6
3.2 Abnormalities from standard conditions	6
3.3 Test Location	6
4 GENERAL INFORMATION	7
4.1 Test frequencies	8
4.2 EUT Peripheral List	8
4.3 Test Peripheral List	8
4.4 TEST METHODOLOGY	9
4.5 Description of Test Modes	10
5 EQUIPMENT USED DURING TEST	13
6 TEST RESULTS AND MEASUREMENT DATA	14
6.1 Antenna requirement	14
6.1.1 Standard requirement:	14
6.1.2 EUT Antenna:	14
6.2 On Time and Duty Cycle	15
6.2.1 Standard requirement:	15
6.2.2 Measuring Instruments and Setting:	15
6.2.3 Test Procedures	15
6.2.4 Test Setup Layout	15
6.2.5 EUT Operation during Test	15
6.2.6 Test result	15
6.3 Maximum Conducted Output Power Measurement	16
6.3.1 Standard requirement:	16
6.3.2 Measuring Instruments:	16
6.3.3 Test Procedures:	16
6.3.4 Test Setup Layout	17
6.3.5 EUT Operation during Test	17
6.3.6 Test result	17
6.4 6dB Bandwidth Measurement	18
6.4.1 Standard requirement:	18
6.4.2 Measuring Instruments:	18
6.4.3 Test Procedures	18
6.4.4 Test Setup Layout	18

6.4.5	EUT Operation during Test	18
6.4.6	Test result	18
6.5	99% Occupied Bandwidth Measurement	19
6.5.1	Standard requirement:	19
6.5.2	Measuring Instruments:	19
6.5.3	Test Procedures	19
6.5.4	Test Setup Layout	19
6.5.5	EUT Operation during Test	19
6.5.6	Test result	19
6.6	Power Spectral Density	21
6.6.1	Standard requirement:	21
6.6.2	Measuring Instruments and Setting:	21
6.6.3	Test Procedures	21
6.6.4	Test Setup Layout	21
6.6.5	EUT Operation during Test	21
6.6.6	Test result	21
6.7	Radiated Emissions and Radiation Restricted band Measurement	23
6.7.1	Standard requirement:	23
6.7.2	Measuring Instruments and Setting:	24
6.7.3	Test Procedures	24
6.7.4	Test Setup Layout	27
6.7.5	EUT Operation during Test	28
6.7.6	Test result	28
6.8	Power Line Conducted Emissions	44
6.8.1	Standard requirement:	44
6.8.2	Test Setup Layout	44
6.8.3	EUT Operation during Test	44
6.8.4	Test Procedures	44
6.8.5	Test result	44
6.9	Frequency Stability	47
6.9.1	Standard requirement:	47
6.9.2	Measuring Instruments and Setting:	47
6.9.3	Test Procedures	47
6.9.4	Test Setup Layout	47
6.9.5	EUT Operation during Test	47
6.9.6	Test result	48
7	TEST SETUP PHOTOGRAPHS OF EUT	49
8	EXTERNAL PHOTOGRAPHS OF EUT	49
9	INTERNAL PHOTOGRAPHS OF EUT	49



Revision History

Revision	Issue Date	Revisions	Revised By
01	Oct. 13, 2024	Initial Issue	Sean She

2 Test Summary

Test Item	Section in CFR 47	Result
/	On Time and Duty Cycle	/
§15.407(a)	Maximum Conducted Output Power	Pass
§15.407(a)	Power Spectral Density	Pass
§15.407(e)	6dB Bandwidth	Pass
§15.209 §15.407(b)	Radiated Emissions	Pass
§15.20	Emissions at Restricted Band	Pass
§15.407(g)	Frequency Stability	Pass
§15.207(a)	Power Line Conducted Emissions	Pass
§15.203	Antenna Requirements	Pass
§2.1093&§2.1091	RF Exposure	Pass*

Note

1. Test according to ANSI C63.10:2013.
2. The measurement uncertainty is not included in the test result.
3. “*” Test results in other test report (RF Exposure Evaluation Report)

2.1 Statement of the Measurement Uncertainty

The data and results referenced in this document are true and accurate. The reader is cautioned that there may be errors within the calibration limits of the equipment and facilities. The measurement uncertainty was calculated for all measurements listed in this test report acc. To CISPR 16 – 4 “Specification for radio disturbance and immunity measuring apparatus and methods – Part 4: Uncertainty in EMC Measurements” and is documented in the AiT quality system acc. To DIN EN ISO/IEC 17025. Furthermore, component and process variability of devices similar to that tested may result in additional deviation. The manufacturer has the sole responsibility of continued compliance of the device.

2.2 Measurement Uncertainty

Test Item	Frequency Range	Measurement Uncertainty	Notes
Radiated Emission	0.009MHz-30MHz	3.10dB	(1)
Radiated Emission	30MHz-1GHz	3.75dB	(1)
Radiated Emission	1GHz-18GHz	3.88dB	(1)
Radiated Emission	18GHz-40GHz	3.88dB	(1)
AC Power Line Conducted Emission	0.15MHz ~ 30MHz	1.20dB	(1)

Note (1): The measurement uncertainty is for coverage factor of k=2 and a level of confidence of 95%.

3 Test Facility

The test facility is recognized, certified or accredited by the following organizations:

FCC-Registration No.: 251906 Designation Number: CN1376

Guangdong Asia Hongke Test Technology Limited has been registered and fully described in a report filed with the (FCC) Federal Communications Commission. The acceptance letter from the FCC is maintained in our files.

IC —Registration No.: 31737 CAB identifier: CN0165

The 3m Semi-anechoic chamber of Guangdong Asia Hongke Test Technology Limited has been registered by Certification and Engineering Bureau of Industry Canada for radio equipment testing with Registration No.: 31737

A2LA-Lab Cert. No.: 7133.01

Guangdong Asia Hongke Test Technology Limited has been accredited by A2LA for technical competence in the field of electrical testing, and proved to be in compliance with ISO/IEC 17025: 2017 General Requirements for the Competence of Testing and Calibration Laboratories and any additional program requirements in the identified field of testing.

3.1 Deviation from standard

None

3.2 Abnormalities from standard conditions

None

3.3 Test Location

Guangdong Asia Hongke Test Technology Limited

Address: B1/F, Building 11, Junfeng Industrial Park, Chongqing Road, Heping Community, Fuhai Street, Bao'an District, Shenzhen, Guangdong, China

Tel.: +86 0755-230967639 Fax.: +86 0755-230967639

4 General Information

EUT Name:	Hi-End Music Streamer
Model No:	DMP-A10
Brand Name:	Eversolo
Serial Model:	N/A
Sample(s) Status:	Engineer sample
Operation frequency:	5745MHz-5825MHz
Modulation Technology:	5 channels for 20MHz bandwidth(5745MHz-5825MHz) 2 channels for 40MHz bandwidth(5755MHz~5795MHz) 1 channels for 80MHz bandwidth(5775MHz)
Modulation Type	IEEE 802.11a/n/ac/ax: OFDM(64QAM, 16QAM, QPSK, BPSK)
Antenna Type:	Stick Antenna
Antenna gain:	3.91dBi
H/W No.:	N/A
S/W No.:	N/A
Adapter:	Input: 100-240V 50/60Hz 0.4A Output: 12V=2.5A 30W
Model different:	N/A
Note:	For a more detailed features description, please refer to the manufacturer's specifications or the User's Manual.

4.1 Test frequencies

EUT channels and frequencies list:

Frequency Band	Channel No.	Frequency (MHz)	Channel No.	Frequency (MHz)
5745~5825MHz	149	5745	155	5775
	151	5755	159	5795
	153	5765	161	5805
	157	5785	165	5825

For IEEE 802.11a/n HT20/ac VHT20/ax HE20, Channel 149, 157 and 165 were tested.
 For IEEE 802.11n HT40/ac VHT40/ax HE40, Channel 151 and 159 were tested.
 For IEEE 802.11ac VHT80/ax HE80, Channel 155 was tested.

4.2 EUT Peripheral List

No.	Equipment	Manufacturer	EMC Compliance	Model No.	Serial No.	Power cord	Signal cord
1	N/A	N/A	N/A	N/A	N/A	N/A	N/A

4.3 Test Peripheral List

No.	Equipment	Manufacturer	EMC Compliance	Model No.	Serial No.	Power cord	Signal cord
1	Notebook	DELL	VOSTRO.3 800	DELL	N/A	N/A	N/A
2	USB Cable	N/A	N/A	100cm	N/A	N/A	N/A

4.4 TEST METHODOLOGY

All measurements contained in this report were conducted with ANSI C63.10-2013, American National Standard of Procedures for Compliance Testing of Unlicensed Wireless Devices.

The radiated testing was performed at an antenna-to-EUT distance of 3 meters. All radiated and conducted emissions measurement was performed at Guangdong Asia Hongke Test Technology Limited

4.4.1 EUT Configuration

The EUT configuration for testing is installed on RF field strength measurement to meet the Commissions requirement and operating in a manner that intends to maximize its emission characteristics in a continuous normal application.

4.4.2 EUT Exercise

The EUT was operated in the engineering mode to fix the TX frequency that was for the purpose of the measurements.

According to FCC's request, Test Procedure 789033 D02 General UNII Test Procedures New Rules v01r03 and KDB 662911 D01 Multiple Transmitter Output v02r01 is required to be used for this kind of FCC 15.407 UII device.

According to its specifications, the EUT must comply with the requirements of the Section 15.203, 15.205, 15.207, 15.209 and 15.407 under the FCC Rules Part 15 Subpart E

4.4.3 General Test Procedures

Conducted Emissions

The EUT is placed on the turntable, which is 0.8 m above ground plane. According to the requirements in Section 6.2.1 of ANSI C63.10-2013 Conducted emissions from the EUT measured in the frequency range between 0.15 MHz and 30MHz using Quasi-peak and average detector modes.

Radiated Emissions

The EUT is placed on a turn table, which is 0.8 m above ground plane. The turntable shall rotate 360 degrees to determine the position of maximum emission level. EUT is set 3m away from the receiving antenna, which varied from 1m to 4m to find out the highest emission. And also, each emission was to be maximized by changing the polarization of receiving antenna both horizontal and vertical. In order to find out the maximum emissions, exploratory radiated emission measurements were made according to the requirements in Section 6.3 of ANSI C63.10-2013.

4.5 Description of Test Modes

The EUT has been tested under operating condition.

This test was performed with EUT in X, Y, Z position and the worst case was found when EUT in X position.

Worst-case mode and channel used for 150 KHz-30 MHz power line conducted emissions was the mode and channel with the highest output power that was determined to be IEEE 802.11ac VHT20 mode (High Channel, at Antenna Chain1).

Worst-case mode and channel used for 9 KHz-1000 MHz radiated emissions was the mode and channel with the highest output power, that was determined to be IEEE 802.11ac VHT20 mode (High Channel, at Antenna Chain1).

Pre-test AC conducted emission at both voltage AC 120V/60Hz and AC 240V/50Hz, recorded worst case.

Worst-Case data rates were utilized from preliminary testing of the Chipset, worst-case data rates used during the testing are as follows:

IEEE 802.11a Mode: 6 Mbps, OFDM.

IEEE 802.11ac VHT20 Mode: MCS0

IEEE 802.11n HT20 Mode: MCS0, OFDM.

IEEE 802.11ac VHT40 Mode: MCS0, OFDM.

IEEE 802.11n HT40 Mode: MCS0, OFDM.

IEEE 802.11ac VHT80 Mode: MCS0, OFDM.

IEEE 802.11ax HE20 Mode: MCS0, OFDM.

IEEE 802.11ax HE40 Mode: MCS0, OFDM.

IEEE 802.11ax HE80 Mode: MCS0, OFDM.

In section 15.31(m), regards to the operating frequency range over 10 MHz, the Lowest frequency, the middle frequency, and the highest frequency of channel were selected to perform the test, and the selected channel see below:

Transmitting mode	Keep the EUT in continuously transmitting mode.					
Test software:	*##9646633##*					
Frequency	5745 MHz	5785 MHz	5825 MHz	--	--	--
Parameters(802.11a)	Default	Default	Default	--	--	--
Parameters(802.11n20)	Default	Default	Default	--	--	--
Parameters(802.11ac20)	Default	Default	Default	--	--	--
Parameters(802.11ax20)	Default	Default	Default			
Frequency	5755 MHz	5795 MHz	--	--	--	--
Parameters(802.11n40)	Default	Default	--	--	--	--
Parameters(802.11ac40)	Default	Default	--	--	--	--
Parameters(802.11ax40)	Default	Default				
Frequency	5775 MHz	--	--	--	--	--



Parameters(802.11ac80)	Default	--	--	--	--	--
Parameters(802.11ax80)	Default					

Antenna & Bandwidth

Antenna Bandwidth Mode	Chain 1 (ANT1)			Chain 2 (ANT2)			Simultaneously
	20MHz	40MHz	80MHz	20MHz	40MHz	80MHz	/
IEEE 802.11a	<input checked="" type="checkbox"/>	<input type="checkbox"/>	<input type="checkbox"/>	<input checked="" type="checkbox"/>	<input type="checkbox"/>	<input type="checkbox"/>	<input type="checkbox"/>
IEEE 802.11n	<input checked="" type="checkbox"/>	<input checked="" type="checkbox"/>	<input type="checkbox"/>	<input checked="" type="checkbox"/>	<input checked="" type="checkbox"/>	<input type="checkbox"/>	<input checked="" type="checkbox"/>
IEEE 802.11ac	<input checked="" type="checkbox"/>	<input checked="" type="checkbox"/>	<input checked="" type="checkbox"/>	<input checked="" type="checkbox"/>	<input checked="" type="checkbox"/>	<input checked="" type="checkbox"/>	<input checked="" type="checkbox"/>
IEEE 802.11ax	<input checked="" type="checkbox"/>	<input checked="" type="checkbox"/>	<input checked="" type="checkbox"/>	<input checked="" type="checkbox"/>	<input checked="" type="checkbox"/>	<input checked="" type="checkbox"/>	<input checked="" type="checkbox"/>

5 Equipment Used during Test

No	Test Equipment	Manufacturer	Model No	Serial No	Cal. Date	Cal. Due Date
1	Spectrum Analyzer	R&S	FSV40	101470	2024.09.25	2025.09.24
2	Spectrum Analyzer	Keysight	N9020A	MY51280643	2024.09.25	2025.09.24
3	EMI Measuring Receiver	R&S	ESR	101660	2024.09.25	2025.09.24
4	Low Noise Pre-Amplifier	HP	HP8447E	1937A01855	2024.09.25	2025.09.24
5	Low Noise Pre-Amplifier	Tsj	MLA-0120-A02-34	2648A04738	2024.09.25	2025.09.24
6	Passive Loop	ETS	6512	00165355	2024.09.25	2025.09.24
7	TRILOG Super Broadband test Antenna	SCHWARZBECK	VULB9160	9160-3206	2024.08.28	2027.08.27
8	Broadband Horn Antenna	SCHWARZBECK	BBHA9120D	452	2024.08.28	2027.08.27
9	SHF-EHF Horn Antenna 15-40GHz	SCHWARZBECK	BBHA9170	BBHA9170367d	2024.08.28	2027.08.27
10	EMI Measuring Receiver	R&S	ESR	101160	2024.09.25	2025.09.24
11	LISN	SCHWARZBECK	NNLK 8129	8130179	2024.09.25	2025.09.24
12	Pulse Limiter	R&S	ESH3-Z2	102789	2024.09.25	2025.09.24
13	Pro.Temp&Humi.chamber	MENTEK	MHP-150-1C	MAA08112501	2024.09.25	2025.09.24
14	RF Automatic Test system	MW	MW100-RFCB	21033016	2024.09.25	2025.09.24
15	Signal Generator	Agilent	N5182A	MY50143009	2024.09.25	2025.09.24
16	Wideband Radio communication tester	R&S	CMW500	1201.0002K50	2024.09.25	2025.09.24
17	RF Automatic Test system	MW	MW100-RFCB	21033016	2024.09.25	2025.09.24
18	DC power supply	ZHAOXIN	RXN-305D-2	28070002559	N/A	N/A
19	RE Software	EZ	EZ-EMC_RE	Ver.AIT-03A	N/A	N/A
20	CE Software	EZ	EZ-EMC_CE	Ver.AIT-03A	N/A	N/A
21	RF Software	MW	MTS 8310	2.0.0.0	N/A	N/A
22	temporary antenna connector(Note)	NTS	R001	N/A	N/A	N/A

Note: The temporary antenna connector is soldered on the PCB board in order to perform conducted tests and this temporary antenna connector is listed in the equipment list.

6 Test results and Measurement Data

6.1 Antenna requirement

6.1.1 Standard requirement:

For intentional device, according to FCC 47 CFR Section 15.203:

An intentional radiator shall be designed to ensure that no antenna other than that furnished by the responsible party shall be used with the device. The use of a permanently attached antenna or of an antenna that uses a unique coupling to the intentional radiator, the manufacturer may design the unit so that a broken antenna can be replaced by the user, but the use of a standard antenna jack or electrical connector is prohibited

And according to FCC 47 CFR Section 15.407 (a), if transmitting antennas of directional gain greater than 6dBi are used, the power shall be reduced by the amount in dB that the directional gain of the antenna exceeds 6dBi.

According to § 15.203 & RSS-Gen, an intentional radiator shall be designed to ensure that no antenna other than that furnished by the responsible party shall be used with the device.

6.1.2 EUT Antenna:

The antenna is Stick Antenna, the best case gain of the antenna is 3.91dBi reference to the Internal photos for details

6.2 On Time and Duty Cycle

6.2.1 Standard requirement:

None; for reporting purpose only

6.2.2 Measuring Instruments and Setting:

Please refer to equipments list in this report. The following table is the setting of the spectrum analyser.

6.2.3 Test Procedures

- 1). Set the Centre frequency of the spectrum analyzer to the transmitting frequency;
- 2). Set the span=0MHz, RBW=8MHz, VBW=50MHz, Sweep time=10.13ms;
- 3). Detector = peak;
- 4). Trace mode = Single hold.

6.2.4 Test Setup Layout

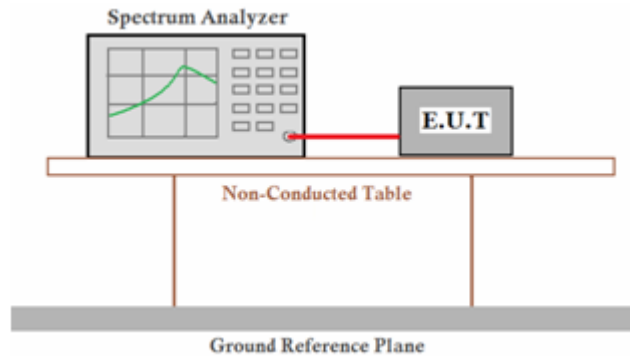

6.2.5 EUT Operation during Test

The EUT was programmed to be in continuously transmitting mode.

6.2.6 Test result

For reporting purpose only.

Please refer to Appendix D

6.3 Maximum Conducted Output Power Measurement

6.3.1 Standard requirement:

For 5725~5850MHz

For the band 5.725-5.85 GHz, the maximum conducted output power over the frequency band of operation shall not exceed 1 W. In addition, the maximum power spectral density shall not exceed 30 dBm in any 500-kHz band. If transmitting antennas of directional gain greater than 6 dBi are used, both the maximum conducted output power and the maximum power spectral density shall be reduced by the amount in dB that the directional gain of the antenna exceeds 6 dBi. However, fixed point-to-point U-NII devices operating in this band may employ transmitting antennas with directional gain greater than 6 dBi without any corresponding reduction in transmitter conducted power. Fixed, point-to-point operations exclude the use of point-to-multipoint systems, omnidirectional applications, and multiple collocated transmitters transmitting the same information. The operator of the U-NII device, or if the equipment is professionally installed, the installer, is responsible for ensuring that systems employing high gain directional antennas are used exclusively for fixed, point-to-point operations.

6.3.2 Measuring Instruments:

Please refer to equipment list in this report.

6.3.3 Test Procedures:

Method SA-2A uses rms detection with slow sweep with each spectrum bin averaging across ON and OFF times of the EUT transmissions, followed by duty cycle correction. The procedure for this method is as follows:

- a) Measure the duty cycle D of the transmitter output signal as described in 12.2.
- b) Set span to encompass the entire 26 dB EBW or 99% OBW of the signal.
- c) Set RBW = 1 MHz.
- d) Set VBW ≥ 3 MHz.
- e) Number of points in sweep $\geq [2 \times \text{span} / \text{RBW}]$. (This gives bin-to-bin spacing $\geq \text{RBW} / 2$, so that narrowband signals are not lost between frequency bins.)
- f) Manually set sweep time $\geq [10 \times (\text{number of points in sweep}) \times (\text{total ON/OFF period of the transmitted signal})]$.
- g) Set detector = RMS (power averaging).
- h) Perform a single sweep.
- i) Compute power by integrating the spectrum across the 26 dB EBW or 99% OBW of the signal using the instrument's band power measurement function with band limits set equal to the EBW or OBW band edges. If the instrument does not have a band power function, then sum the spectrum levels (in power units) at 1 MHz intervals extending across the 26 dB EBW of the spectrum.
- j) Add $[10 \log (1 / D)]$, where D is the duty cycle, to the measured power to compute the average power during the actual transmission times (because the measurement represents an average over both the ON and OFF times of the transmission). For example, add $[10 \log (1 / 0.25)] = 6$ dB if the duty cycle is 25%.

6.3.4 Test Setup Layout

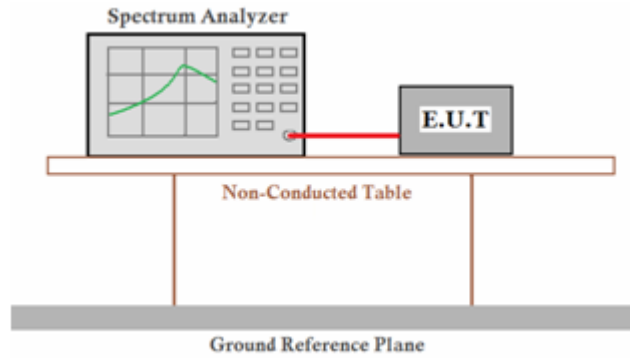

6.3.5 EUT Operation during Test

The EUT was programmed to be in continuously transmitting mode.

6.3.6 Test result

PASS

Please refer to Appendix D

Remark:

1. Measured output power at difference data rate for each mode and recorded worst case for each mode.
2. Test results including cable loss;
3. Worst case data at 6Mbps at IEEE 802.11a; MCS0 at IEEE 802.11n HT20, IEEE 802.11n HT40, IEEE 802.11ac VHT20, IEEE 802.11ac VHT40, IEEE 802.11ac VHT80; IEEE 802.11ax HE20, IEEE 802.11ax HE40, IEEE 802.11ax HE80;
4. Report conducted power = Measured conducted average power + Duty Cycle factor;

6.4 6dB Bandwidth Measurement

6.4.1 Standard requirement:

Within the 5.725-5.85 GHz band, the minimum 6 dB bandwidth of U-NII devices shall be at least 500 kHz.

6.4.2 Measuring Instruments:

Please refer to equipment list in this report. The following table is the setting of the Spectrum Analyzer.

Spectrum Parameter	Setting
Attenuation	Auto
Span	> 26dB Bandwidth
Detector	Peak
Trace	Max Hold
Sweep Time	Auto

6.4.3 Test Procedures

1. The transmitter output (antenna port) was connected to the spectrum analyzer in peak hold mode.
2. The resolution bandwidth of 100 KHz and the video bandwidth of 300 KHz were used.
3. Measured the spectrum width with power higher than 6dB below carrier.

6.4.4 Test Setup Layout

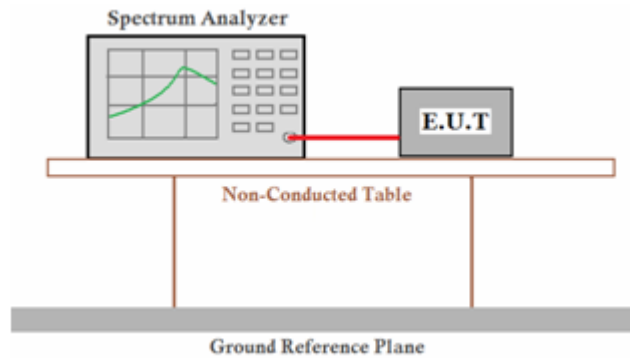

6.4.5 EUT Operation during Test

The EUT was programmed to be in continuously transmitting mode.

6.4.6 Test result

PASS.

Please refer to Appendix D

Remark:

1. Measured 6dB bandwidth at difference data rate for each mode and recorded worst case for each mode.
2. Test results including cable loss;
3. Worst case data at 6Mbps at IEEE 802.11a; MCS0 at IEEE 802.11n HT20, IEEE 802.11n HT40, IEEE 802.11ac VHT20, IEEE 802.11ac VHT40, IEEE 802.11ac VHT80; IEEE 802.11ax HE20, IEEE 802.11ax HE40, IEEE 802.11ax HE80;

6.5 99% Occupied Bandwidth Measurement

6.5.1 Standard requirement:

According to §2.1049: The occupied bandwidth, that is the frequency bandwidth such that, below its lower and above its upper frequency limits, the mean powers radiated are each equal to 0.5 percent of the total mean power radiated by a given emission shall be measured under the following conditions as applicable.

6.5.2 Measuring Instruments:

Please refer to equipment list in this report. The following table is the setting of the Spectrum Analyzer.

Spectrum Parameter	Setting
Attenuation	Auto
RBW	> RBW
VBW	Peak
Span Frequency	Max Hold
Detector	100ms

6.5.3 Test Procedures

1. The transmitter output (antenna port) was connected to the spectrum analyzer in peak hold mode.
2. Set RBW = 1%~5% OBW; VBW \geq 3*RBW;
3. Measured the 99% occupied bandwidth by related function of the spectrum analyzer.

6.5.4 Test Setup Layout

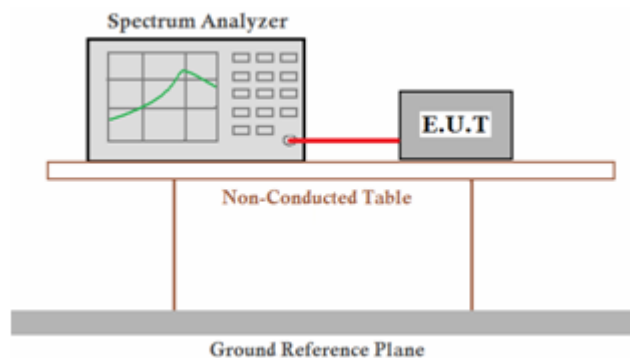

6.5.5 EUT Operation during Test

The EUT was programmed to be in continuously transmitting mode.

6.5.6 Test result

PASS.

Please refer to Appendix D

Remark:

1. *Measured 6dB bandwidth at difference data rate for each mode and recorded worst case for each mode.*
2. *Test results including cable loss;*
3. *Worst case data at 6Mbps at IEEE 802.11a; MCS0 at IEEE 802.11n HT20, IEEE 802.11n HT40, IEEE 802.11ac VHT20, IEEE 802.11ac VHT40, IEEE 802.11ac VHT80; IEEE 802.11ax HE20, IEEE 802.11ax HE40, IEEE 802.11ax HE80;*

6.6 Power Spectral Density

6.6.1 Standard requirement:

For 5725~5850MHz

For the band 5.725-5.85 GHz, the maximum conducted output power over the frequency band of operation shall not exceed 1 W. In addition, the maximum power spectral density shall not exceed 30 dBm in any 500-kHz band. If transmitting antennas of directional gain greater than 6 dBi are used, both the maximum conducted output power and the maximum power spectral density shall be reduced by the amount in dB that the directional gain of the antenna exceeds 6 dBi. However, fixed point-to-point U-NII devices operating in this band may employ transmitting antennas with directional gain greater than 6 dBi without any corresponding reduction in transmitter conducted power. Fixed, point-to-point operations exclude the use of point-to-multipoint systems, omnidirectional applications, and multiple collocated transmitters transmitting the same information. The operator of the U-NII device, or if the equipment is professionally installed, the installer, is responsible for ensuring that systems employing high gain directional antennas are used exclusively for fixed, point-to-point operations.

6.6.2 Measuring Instruments and Setting:

Please refer to equipment list in this report. The following table is the setting of Spectrum Analyzer.

6.6.3 Test Procedures

Refer to section 6.3.3 (except for i), the spectrograph cancels the channel power mode and changes to the spectrum mode.

6.6.4 Test Setup Layout

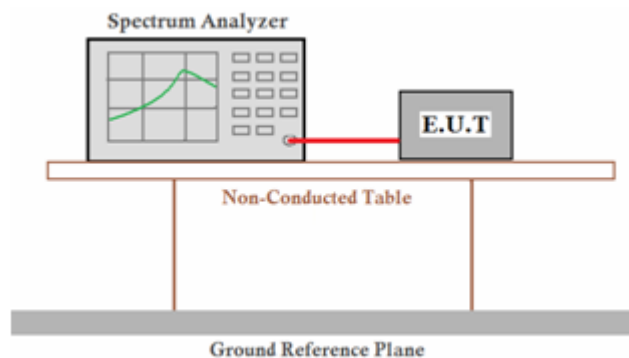

6.6.5 EUT Operation during Test

The EUT was programmed to be in continuously transmitting mode.

6.6.6 Test result

PASS.

Please refer to Appendix D

Remark:

1. Measured power spectrum density at difference data rate for each mode and recorded worst case for each mode.

2. *Test results including cable loss;*
3. *Worst case data at 6Mbps at IEEE 802.11a; MCS0 at IEEE 802.11n HT20, IEEE 802.11n HT40, IEEE 802.11ac VHT20, IEEE 802.11ac VHT40, IEEE 802.11ac VHT80; IEEE 802.11ax HE20, IEEE 802.11ax HE40, IEEE 802.11ax HE80;*
4. *Report conducted PSD = measured conducted PSD + Duty Cycle factor + RBW factor;*
RBW factor = $10 \log (500 \text{ KHz} / 300 \text{ KHz}) = 2.218 \text{ dB}$;

6.7 Radiated Emissions and Radiation Restricted band Measurement

6.7.1 Standard requirement:

15.205 (a) Except as shown in paragraph (d) of this section, only spurious emissions are permitted in any of the frequency bands listed below:

MHz	MHz	MHz	GHz
0.090-0.110	16.42-16.423	399.9-410	4.5-5.15
\1\ 0.495-0.505	16.69475-16.69525	608-614	5.35-5.46
2.1735-2.1905	16.80425-16.80475	960-1240	7.25-7.75
4.125-4.128	25.5-25.67	1300-1427	8.025-8.5
4.17725-4.17775	37.5-38.25	1435-1626.5	9.0-9.2
4.20725-4.20775	73-74.6	1645.5-1646.5	9.3-9.5
6.215-6.218	74.8-75.2	1660-1710	10.6-12.7
6.26775-6.26825	108-121.94	1718.8-1722.2	13.25-13.4
6.31175-6.31225	123-138	2200-2300	14.47-14.5
8.291-8.294	149.9-150.05	2310-2390	15.35-16.2
8.362-8.366	156.52475-156.52525	2483.5-2500	17.7-21.4
8.37625-8.38675	156.7-156.9	2690-2900	22.01-23.12
8.41425-8.41475	162.0125-167.17	3260-3267	23.6-24.0
12.29-12.293.	167.72-173.2	3332-3339	31.2-31.8
12.51975-12.52025	240-285	3345.8-3358	36.43-36.5
12.57675-12.57725	322-335.4	3600-4400	(\2\)
13.36-13.41			

\1\ Until February 1, 1999, this restricted band shall be 0.490-0.510 MHz.

\2\ Above 38.6

For transmitters operating in the 5.725-5.85 GHz band:

All emissions shall be limited to a level of -27 dBm/MHz(68.2dBuV/m at 3m) at 75 MHz or more above or below the band edge increasing linearly to 10 dBm/MHz(105.2dBuV/m at 3m) at 25 MHz above or below the band edge, and from 25 MHz above or below the band edge increasing linearly to a level of 15.6(110.8dBuV/m at 3m) dBm/MHz at 5 MHz above or below the band edge, and from 5 MHz above or below the band edge increasing linearly to a level of 27 dBm/MHz(122.2dBuV/m at 3m) at the band edge.

In addition, In case the emission fall within the restricted band specified on 15.205(a), then the 15.209(a) limit in the table below has to be followed.

IFrequencies (MHz)	Field Strength (microvolts/meter)	Measurement Distance (meters)
0.009~0.490	2400/F(KHz)	300
0.490~1.705	24000/F(KHz)	30
1.705~30.0	30	30
30~88	100	3
88~216	150	3
216~960	200	3

Above 960	500	3
-----------	-----	---

6.7.2 Measuring Instruments and Setting:

Please refer to equipment list in this report. The following table is the setting of spectrum analyzer and receiver.

Spectrum Parameter	Setting
Attenuation	Auto
Start Frequency	1000 MHz
Stop Frequency	10 th carrier harmonic
RB / VB (Emission in restricted band)	1MHz / 1MHz for Peak, 1 MHz / 1/B kHz for Average
RB / VB (Emission in non-restricted band)	1MHz / 1MHz for Peak, 1 MHz / 1/B kHz for Average

Receiver Parameter	Setting
Attenuation	Auto
Start ~ Stop Frequency	9kHz~150kHz / RB/VB 200Hz/1KHz for QP/AVG
Start ~ Stop Frequency	150kHz~30MHz / RB/VB 9kHz/30KHz for QP/AVG
Start ~ Stop Frequency	30MHz~1000MHz / RB/VB 120kHz/1MHz for QP

6.7.3 Test Procedures

1) Sequence of testing 9 kHz to 30 MHz

Setup:

- The equipment was set up to simulate a typical usage like described in the user manual or described by manufacturer.
- If the EUT is a tabletop system, a rotatable table with 0.8 m height is used.
- If the EUT is a floor standing device, it is placed on the ground.
- Auxiliary equipment and cables were positioned to simulate normal operation conditions.
- The AC power port of the EUT (if available) is connected to a power outlet below the turntable.
- The measurement distance is 3 meter.
- The EUT was set into operation.

Premeasurement:

- The turntable rotates from 0° to 315° using 45° steps.
- The antenna height is 1.5 meter.
- At each turntable position the analyzer sweeps with peak detection to find the maximum of all emissions

Final measurement:

- Identified emissions during the premeasurement the software maximizes by rotating the turntable position (0° to 360°) and by rotating the elevation axes (0° to 360°).
- The final measurement will be done in the position (turntable and elevation) causing the highest emissions with QPK detector.
- The final levels, frequency, measuring time, bandwidth, turntable position, correction factor, margin to the limit and limit will be recorded. Also a plot with the graph of the premeasurement and

the limit will be stored.

2) Sequence of testing 30 MHz to 1 GHz

Setup:

--- The equipment was set up to simulate a typical usage like described in the user manual or described by manufacturer.

--- If the EUT is a tabletop system, a table with 0.8 m height is used, which is placed on the ground plane.

--- If the EUT is a floor standing device, it is placed on the ground plane with insulation between both.

--- Auxiliary equipment and cables were positioned to simulate normal operation conditions

--- The AC power port of the EUT (if available) is connected to a power outlet below the turntable.

--- The measurement distance is 3 meter.

--- The EUT was set into operation.

Premeasurement:

--- The turntable rotates from 0° to 315° using 45° steps.

--- The antenna is polarized vertical and horizontal.

--- The antenna height changes from 1 to 3 meter.

--- At each turntable position, antenna polarization and height the analyzer sweeps three times in peak to find the maximum of all emissions.

Final measurement:

--- The final measurement will be performed with minimum the six highest peaks.

--- According to the maximum antenna and turntable positions of premeasurement the software maximize the peaks by changing turntable position ($\pm 45^\circ$) and antenna movement between 1 and 4 meter.

--- The final measurement will be done with QP detector with an EMI receiver.

--- The final levels, frequency, measuring time, bandwidth, antenna height, antenna polarization, turntable angle, correction factor, margin to the limit and limit will be recorded. Also a plot with the graph of the premeasurement with marked maximum final measurements and the limit will be stored.

3) Sequence of testing 1 GHz to 18 GHz

Setup:

- The equipment was set up to simulate a typical usage like described in the user manual or described by manufacturer.
- If the EUT is a tabletop system, a rotatable table with 1.5 m height is used.
- If the EUT is a floor standing device, it is placed on the ground plane with insulation between both.
- Auxiliary equipment and cables were positioned to simulate normal operation conditions
- The AC power port of the EUT (if available) is connected to a power outlet below the turntable.
- The measurement distance is 3 meter.
- The EUT was set into operation.

Premeasurement:

- The turntable rotates from 0° to 315° using 45° steps.
- The antenna is polarized vertical and horizontal.
- The antenna height scan range is 1 meter to 2.5 meter.
- At each turntable position and antenna polarization the analyzer sweeps with peak detection to find the maximum of all emissions.

Final measurement:

- The final measurement will be performed with minimum the six highest peaks.
- According to the maximum antenna and turntable positions of premeasurement the software maximize the peaks by changing turntable position ($\pm 45^\circ$) and antenna movement between 1 and 4 meter. This procedure is repeated for both antenna polarizations.
- The final measurement will be done in the position (turntable, EUT-table and antenna polarization) causing the highest emissions with Peak and Average detector.
- The final levels, frequency, measuring time, bandwidth, turntable position, EUT-table position, antenna polarization, correction factor, margin to the limit and limit will be recorded. Also a plot with the graph of the premeasurement with marked maximum final measurements and the limit will be stored.

4) Sequence of testing above 18 GHz

Setup:

- The equipment was set up to simulate a typical usage like described in the user manual or described by manufacturer.
- If the EUT is a tabletop system, a rotatable table with 1.5 m height is used.
- If the EUT is a floor standing device, it is placed on the ground plane with insulation between both.
- Auxiliary equipment and cables were positioned to simulate normal operation conditions
- The AC power port of the EUT (if available) is connected to a power outlet below the turntable.
- The measurement distance is 1 meter.
- The EUT was set into operation.

Premeasurement:

- The antenna is moved spherical over the EUT in different polarisations of the antenna.

Final measurement:

- The final measurement will be performed at the position and antenna orientation for all detected emissions that were found during the premeasurements with Peak and Average detector.
- The final levels, frequency, measuring time, bandwidth, correction factor, margin to the limit and limit will be recorded. Also a plot with the graph of the premeasurement and the limit will be stored.

6.7.4 Test Setup Layout

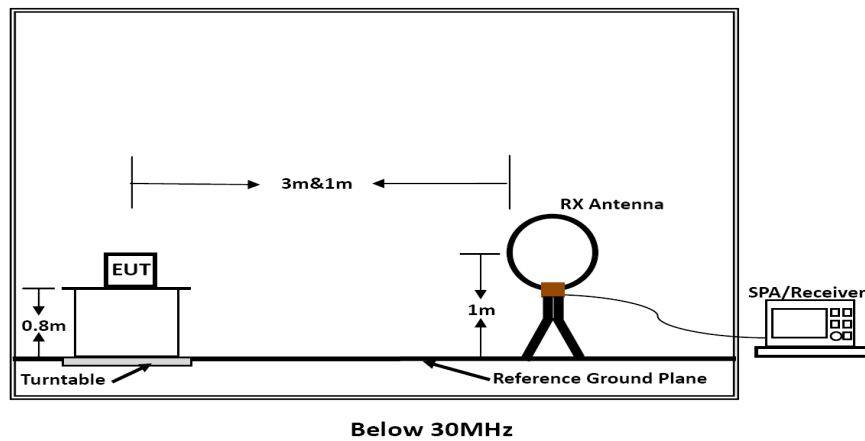

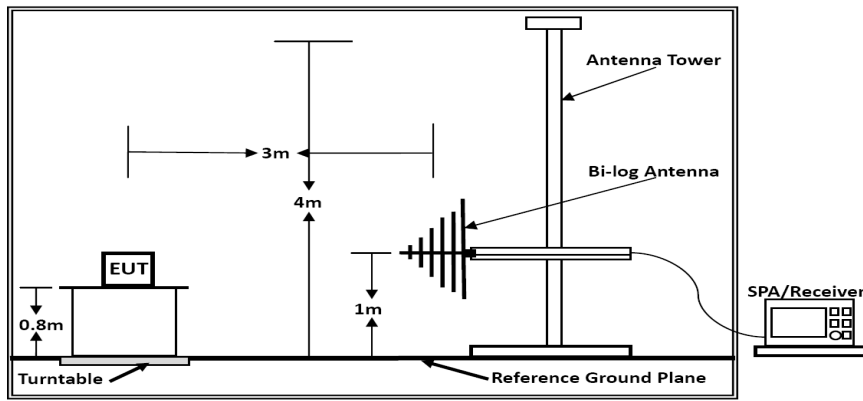

Below 1GHz

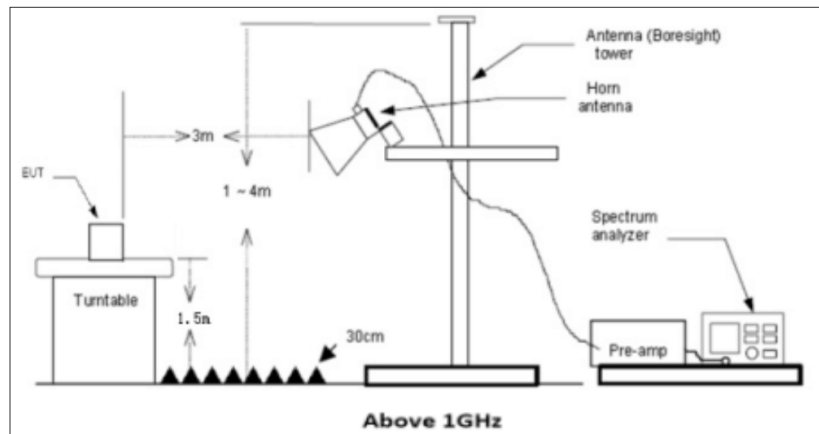

Above 1GHz

Above 18 GHz shall be extrapolated to the specified distance using an extrapolation factor of 20 dB/decade from 3m to 1m.

Distance extrapolation factor = $20 \log(\text{specific distance [3m]} / \text{test distance [1m]})$ (dB);

Limit line = specific limits (dBuV) + distance extrapolation factor [6 dB].

6.7.5 EUT Operation during Test

The EUT was programmed to be in continuously transmitting mode.

6.7.6 Test result

Temperature	25.8°C	Humidity	52.5%
Configurations	IEEE 802.11a/n/ac		

Remarks:

1. Only the worst case Main Antenna test data.
2. Pre-scan all kind of the place mode (X-axis, Y-axis, Z-axis), and found the Y-axis which it is worse case.

■ Results of Radiated Emissions (9 KHz~30MHz)

Freq. (MHz)	Level (dBuV)	Over Limit (dB)	Over Limit (dBuV)	Remark
-	-	-	-	See Note

Note:

The emission from 9 kHz to 30MHz was pre-tested and found the result was 20dB lower than the limit, and the permissible value has no need to be reported.

Distance extrapolation factor = $40 \log(\text{specific distance} / \text{test distance})$ (dB);

Limit line = specific limits (dBuV) + distance extrapolation factor.

■ Results of Radiated Emissions (30MHz~1GHz)

Pre-scan all modes and recorded the worst case results in this report (IEEE 802.11ac(VHT40)).

Model name:	DMP-A10	Test Date :	2024-10-09
Polarization :	Vertical	Test Result:	<input checked="" type="checkbox"/> Pass <input type="checkbox"/> Fail

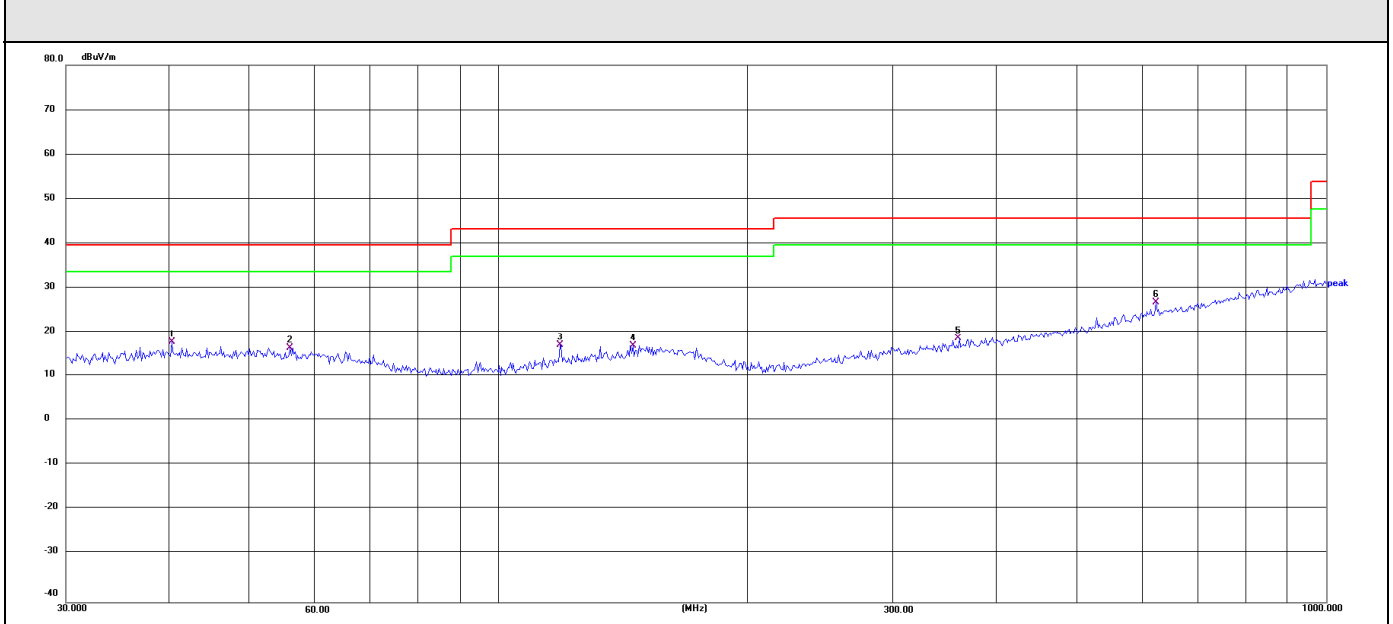

Remark:
 Emission Level = Reading + Factor;
 Factor = Antenna Factor + Cable Loss – Pre-amplifier;
 Margin= Emission Level - Limit.

No.	Frequency (MHz)	Reading (dBuV)	Factor (dB/m)	Level (dBuV/m)	Limit (dBuV/m)	Margin (dB)	Det.
1	40.2757	34.69	-16.46	18.23	40.00	-21.77	QP
2	56.0007	33.94	-17.09	16.85	40.00	-23.15	QP
3	118.6014	36.05	-18.54	17.51	43.50	-25.99	QP
4	145.3506	34.30	-16.89	17.41	43.50	-26.09	QP
5	360.4476	34.62	-15.48	19.14	46.00	-26.86	QP
6 *	622.8900	36.38	-9.22	27.16	46.00	-18.84	QP

Model name:	DMP-A10	Test Date :	2024-10-09
Polarization :	Horizontal	Test Result:	<input checked="" type="checkbox"/> Pass <input type="checkbox"/> Fail

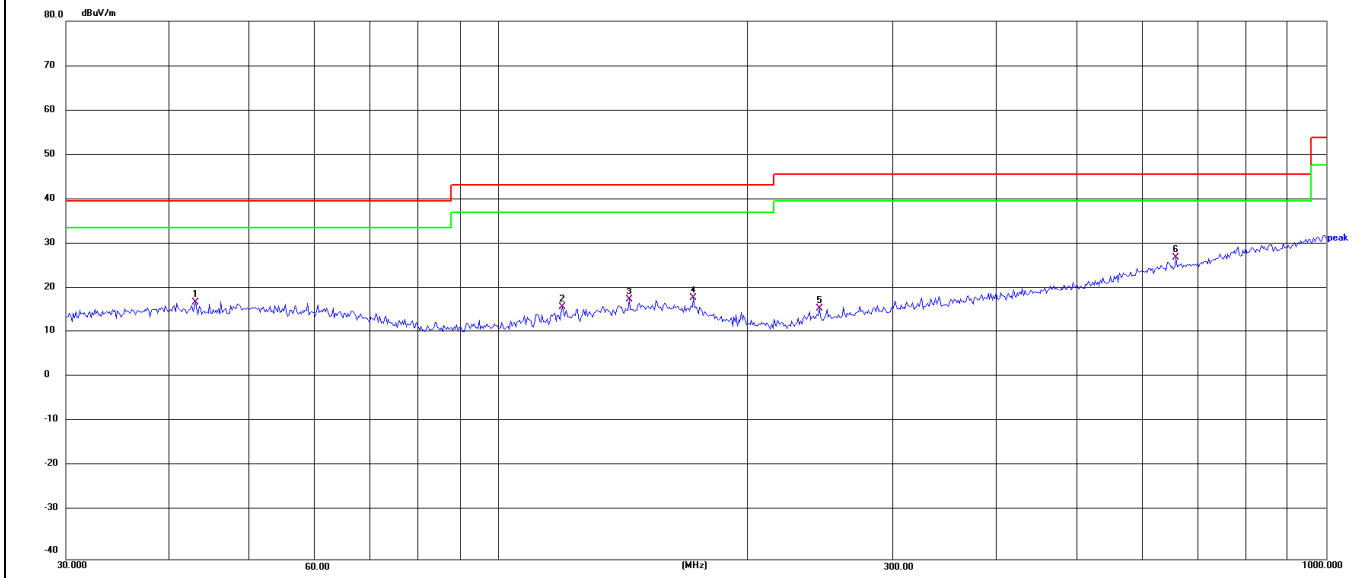

Remark:
 Emission Level = Reading + Factor;
 Factor = Antenna Factor + Cable Loss – Pre-amplifier;
 Margin= Emission Level - Limit.

No.	Frequency (MHz)	Reading (dBuV)	Factor (dB/m)	Level (dBuV/m)	Limit (dBuV/m)	Margin (dB)	Det.
1	43.0505	33.80	-16.61	17.19	40.00	-22.81	QP
2	119.4361	34.61	-18.45	16.16	43.50	-27.34	QP
3	143.8295	34.96	-17.00	17.96	43.50	-25.54	QP
4	171.9946	35.35	-17.14	18.21	43.50	-25.29	QP
5	244.2321	34.61	-18.74	15.87	46.00	-30.13	QP
6 *	658.8362	36.22	-8.78	27.44	46.00	-18.56	QP

Results for Radiated Emissions (1- 40 GHz)

Note: All the modes have been tested and recorded worst mode in the report. (IEEE 802.11ac(VHT40))

Band IV(5.725-5.85) GHz										
Frequency (MHz)	Reading (dBuV)	Amplifier (dB)	Loss (dB)	Antenna Factor (dB/m)	Orrected Factor (dB)	Emission Level (dBμV/m)	Limit (dBuV/m)	Margin (dB)	Detector	Comment
	Low Channel (802.11ac(VHT40)/ 5755 MHz)									
3260.80	43.87	44.70	6.70	28.20	-9.80	34.07	68.20	-34.13	Pk	Vertical
3260.80	41.76	44.70	6.70	28.20	-9.80	31.96	54.00	-22.04	AV	Vertical
3264.94	43.78	44.70	6.70	28.20	-9.80	33.98	68.20	-34.22	Pk	Horizontal
3264.94	41.19	44.70	6.70	28.20	-9.80	31.39	54.00	-22.61	AV	Horizontal
3994.92	39.05	44.20	7.90	29.70	-6.60	32.45	68.20	-35.75	Pk	Vertical
3994.92	35.66	44.20	7.90	29.70	-6.60	29.06	54.00	-24.94	AV	Vertical
3995.48	38.73	44.20	7.90	29.70	-6.60	32.13	68.20	-36.07	Pk	Horizontal
3995.48	37.07	44.20	7.90	29.70	-6.60	30.47	54.00	-23.53	AV	Horizontal
7224.00	36.99	43.50	11.40	35.50	3.40	40.39	68.20	-27.81	Pk	Vertical
7224.00	33.62	43.50	11.40	35.50	3.40	37.02	54.00	-16.98	AV	Vertical
7217.19	37.57	43.50	11.40	35.50	3.40	40.97	68.20	-27.23	Pk	Horizontal
7217.19	33.61	43.50	11.40	35.50	3.40	37.01	54.00	-16.99	AV	Horizontal
10515.92	38.80	44.50	13.90	38.80	8.20	47.00	68.20	-21.20	Pk	Vertical
10515.92	35.75	44.50	13.90	38.80	8.20	43.95	54.00	-10.05	AV	Vertical
10507.18	38.88	44.50	13.90	38.80	8.20	47.08	68.20	-21.12	Pk	Horizontal
10507.18	37.01	44.50	13.90	38.80	8.20	45.21	54.00	-8.79	AV	Horizontal
11490.37	32.76	43.60	14.30	39.50	10.20	42.96	68.20	-25.24	Pk	Vertical
11490.37	29.89	43.60	14.30	39.50	10.20	40.09	54.00	-13.91	AV	Vertical
11490.13	33.07	43.60	14.30	39.50	10.20	43.27	68.20	-24.93	Pk	Horizontal
11490.13	30.37	43.60	14.30	39.50	10.20	40.57	54.00	-13.43	AV	Horizontal
13293.88	32.11	42.60	15.90	38.90	12.20	44.31	68.20	-23.89	Pk	Vertical
13293.88	29.71	42.60	15.90	38.90	12.20	41.91	54.00	-12.09	AV	Vertical
13289.65	31.91	42.60	15.90	38.90	12.20	44.11	68.20	-24.09	Pk	Horizontal
13289.65	29.43	42.60	15.90	38.90	12.20	41.63	54.00	-12.37	AV	Horizontal

High Channel (802.11ac(VHT40)/ 5795 MHz)										
3246.58	44.03	44.70	6.70	28.20	-9.80	34.23	68.20	-33.97	Pk	Vertical
3246.58	41.78	44.70	6.70	28.20	-9.80	31.98	54.00	-22.02	AV	Vertical
3251.25	44.44	44.70	6.70	28.20	-9.80	34.64	68.20	-33.56	Pk	Horizontal
3251.25	41.88	44.70	6.70	28.20	-9.80	32.08	54.00	-21.92	AV	Horizontal
3987.03	39.08	44.20	7.90	29.70	-6.60	32.48	68.20	-35.72	Pk	Vertical
3987.03	36.48	44.20	7.90	29.70	-6.60	29.88	54.00	-24.12	AV	Vertical
4000.16	39.64	44.20	7.90	29.70	-6.60	33.04	68.20	-35.16	Pk	Horizontal
4000.16	36.89	44.20	7.90	29.70	-6.60	30.29	54.00	-23.71	AV	Horizontal
7231.00	36.53	43.50	11.40	35.50	3.40	39.93	68.20	-28.27	Pk	Vertical
7231.00	34.49	43.50	11.40	35.50	3.40	37.89	54.00	-16.11	AV	Vertical
7234.20	37.80	43.50	11.40	35.50	3.40	41.20	68.20	-27.00	Pk	Horizontal
7234.20	34.38	43.50	11.40	35.50	3.40	37.78	54.00	-16.22	AV	Horizontal
10586.56	39.11	44.50	13.80	38.80	8.10	47.21	68.20	-20.99	Pk	Vertical
10586.56	36.20	44.50	13.80	38.80	8.10	44.30	54.00	-9.70	AV	Vertical
10599.08	39.08	44.50	13.80	38.80	8.10	47.18	68.20	-21.02	Pk	Horizontal
10599.08	37.10	44.50	13.80	38.80	8.10	45.20	54.00	-8.80	AV	Horizontal
11570.04	34.05	43.60	14.30	39.50	10.20	44.25	68.20	-23.95	Pk	Vertical
11570.04	30.11	43.60	14.30	39.50	10.20	40.31	54.00	-13.69	AV	Vertical
11570.34	33.80	43.60	14.30	39.50	10.20	44.00	68.20	-24.20	Pk	Horizontal
11570.34	30.87	43.60	14.30	39.50	10.20	41.07	54.00	-12.93	AV	Horizontal
13294.78	32.92	42.60	15.90	38.90	12.20	45.12	68.20	-23.08	Pk	Vertical
13294.78	29.10	42.60	15.90	38.90	12.20	41.30	54.00	-12.70	AV	Vertical
13294.96	32.04	42.60	15.90	38.90	12.20	44.24	68.20	-23.96	Pk	Horizontal
13294.96	28.93	42.60	15.90	38.90	12.20	41.13	54.00	-12.87	AV	Horizontal

Notes:

- 1). Measuring frequencies from 9 KHz ~ 40GHz, No emission found between lowest internal used/generated frequency to 30MHz.
- 2). Radiated emissions measured in frequency range from 9 KHz ~ 40GHz were made with an instrument using Peak detector mode.
- 3). 18~40GHz at least have 20dB margin. No recording in the test report.
- 4). Worst case data at 6Mbps at IEEE 802.11a; MCS0 at IEEE 802.11n HT20, IEEE 802.11n HT40, IEEE 802.11ac VHT20, IEEE 802.11ac VHT40, IEEE 802.11ac VHT80; IEEE 802.11ax HE20, IEEE 802.11ax HE40, IEEE 802.11ax HE80;
- 5). Data of measurement within this frequency range shown “---” in the table above means the reading of emissions are attenuated more than 20dB below the permissible limits or the field strength is too small to be measured.
- 6). Margin= Emission Level – Limit

Undesirable emission:

802.11ax20_Low channel_Horizontal

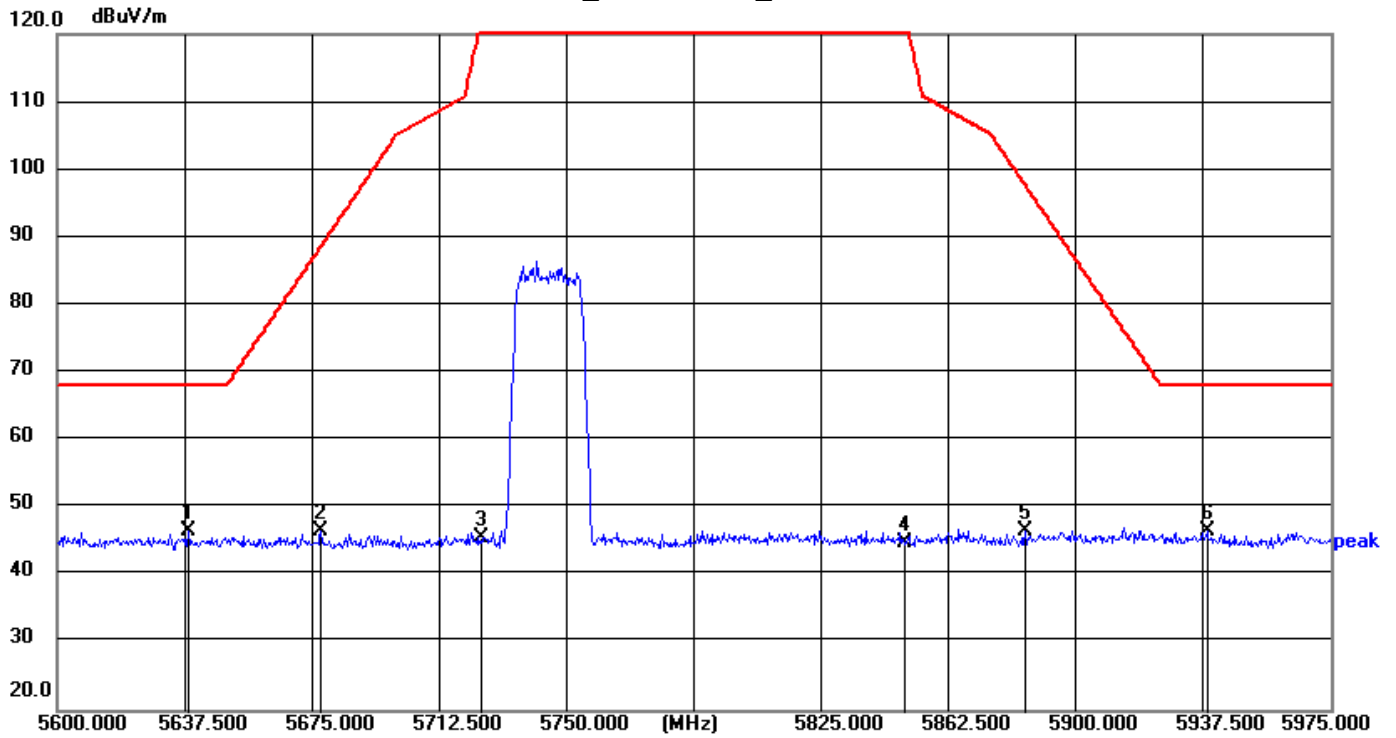

No.	Frequency (MHz)	Reading (dBuV)	Factor (dB/m)	Level (dBuV/m)	Limit (dBuV/m)	Margin (dB)	Det.
1	5638.625	51.23	-4.69	46.54	68.20	-21.66	peak
2	5677.625	51.16	-4.67	46.49	88.64	-42.15	peak
3	5725.000	50.07	-4.57	45.50	122.20	-76.70	peak
4	5850.000	48.95	-4.10	44.85	122.20	-77.35	peak
5	5885.000	50.66	-3.94	46.72	97.80	-51.08	peak
6 *	5938.625	50.64	-3.95	46.69	68.20	-21.51	peak

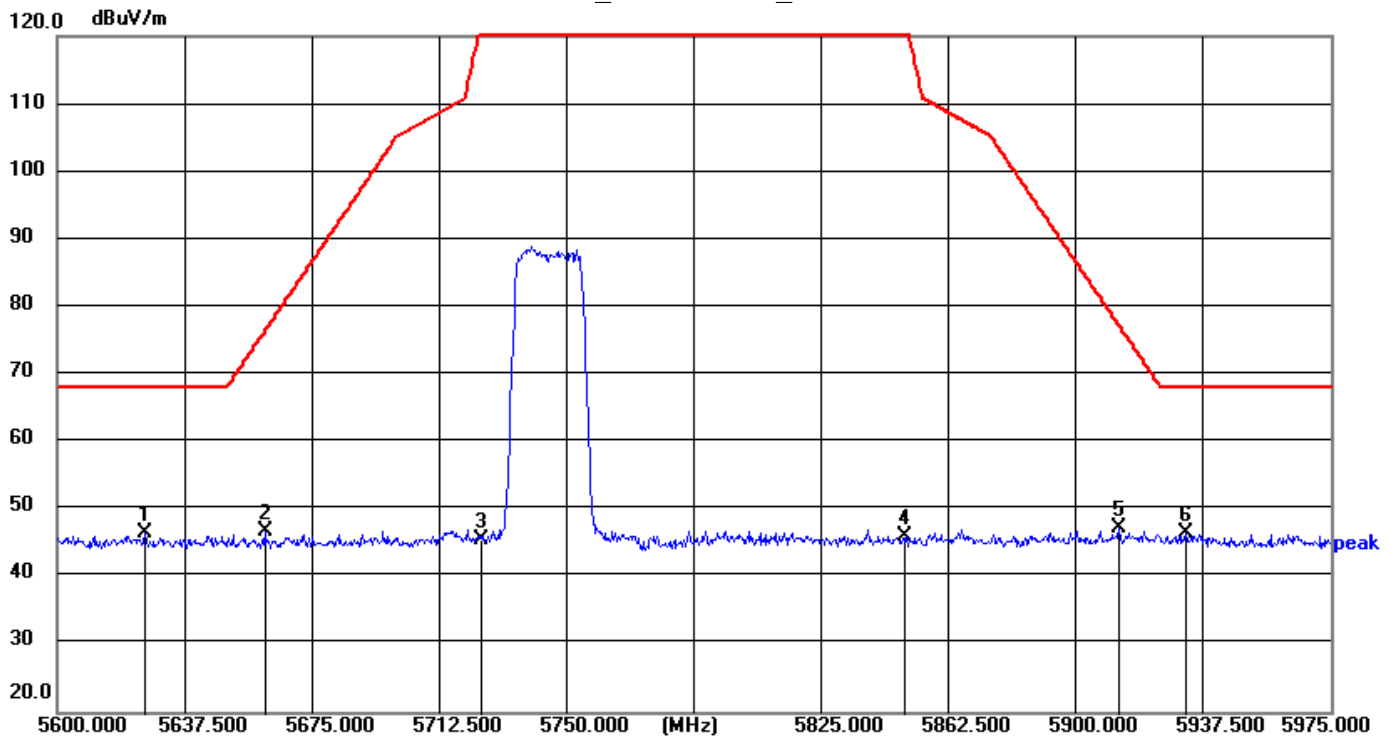

No.	Frequency (MHz)	Reading (dBuV)	Factor (dB/m)	Level (dBuV/m)	Limit (dBuV/m)	Margin (dB)	Det.
1	5625.875	51.18	-4.69	46.49	68.20	-21.71	peak
2	5661.125	51.55	-4.67	46.88	76.43	-29.55	peak
3	5725.000	50.22	-4.57	45.65	122.20	-76.55	peak
4	5850.000	50.28	-4.10	46.18	122.20	-76.02	peak
5	5912.750	51.31	-3.90	47.41	77.27	-29.86	peak
6 *	5932.250	50.54	-3.94	46.60	68.20	-21.60	peak

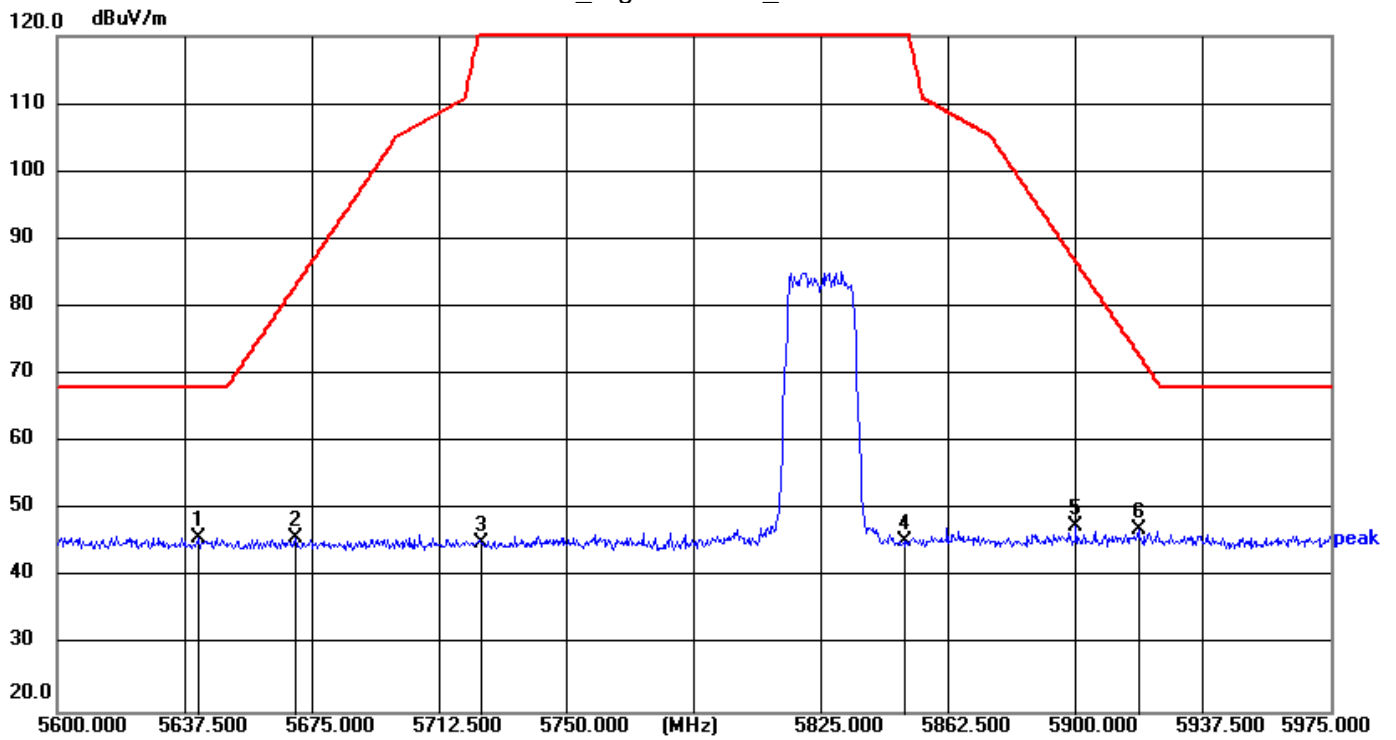

No.	Frequency (MHz)	Reading (dBuV)	Factor (dB/m)	Level (dBuV/m)	Limit (dBuV/m)	Margin (dB)	Det.
1 *	5641.625	50.60	-4.68	45.92	68.20	-22.28	peak
2	5670.125	50.56	-4.67	45.89	83.09	-37.20	peak
3	5725.000	49.59	-4.57	45.02	122.20	-77.18	peak
4	5850.000	49.57	-4.10	45.47	122.20	-76.73	peak
5	5900.000	51.45	-3.88	47.57	86.70	-39.13	peak
6	5918.375	51.10	-3.91	47.19	73.10	-25.91	peak

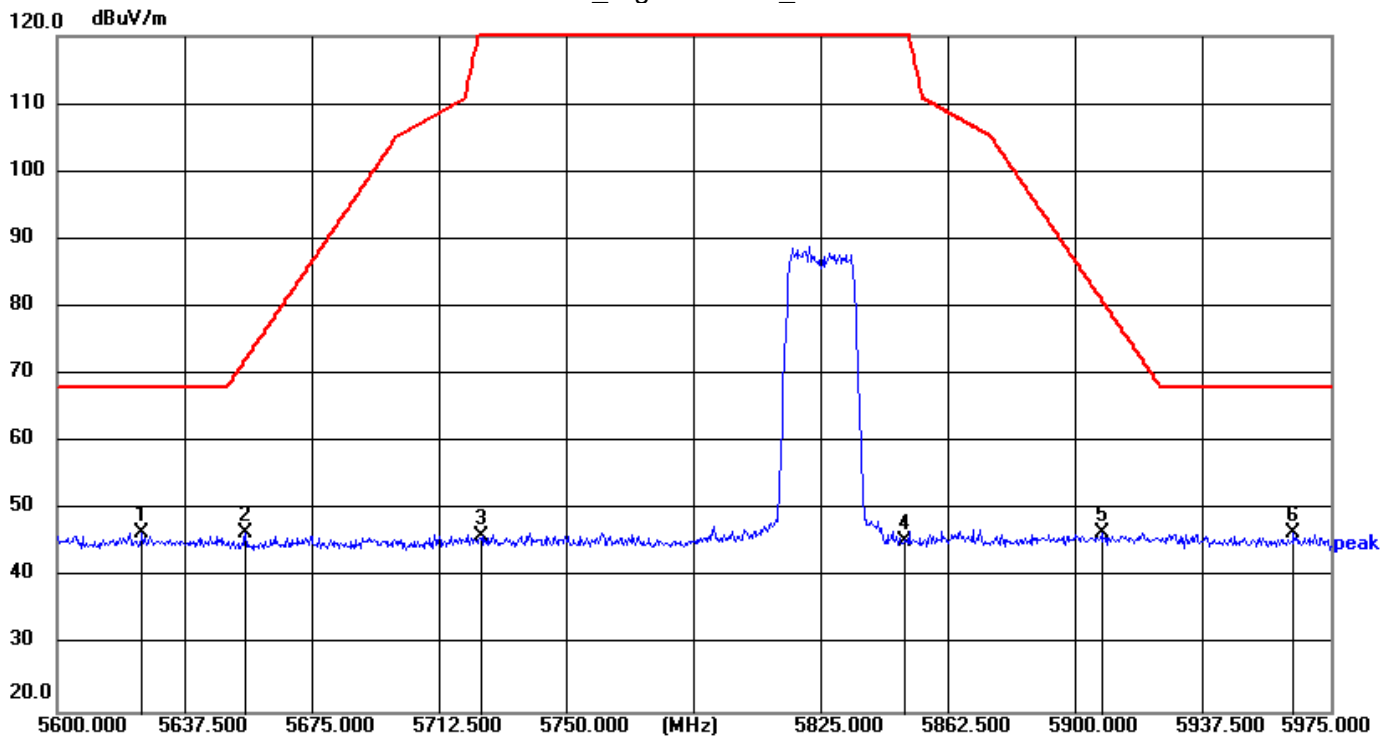

No.	Frequency (MHz)	Reading (dBuV)	Factor (dB/m)	Level (dBuV/m)	Limit (dBuV/m)	Margin (dB)	Det.
1 *	5625.125	51.38	-4.69	46.69	68.20	-21.51	peak
2	5655.500	51.27	-4.68	46.59	72.27	-25.68	peak
3	5725.000	50.59	-4.57	46.02	122.20	-76.18	peak
4	5850.000	49.58	-4.10	45.48	122.20	-76.72	peak
5	5907.500	50.44	-3.89	46.55	81.15	-34.60	peak
6	5964.125	50.68	-3.99	46.69	68.20	-21.51	peak

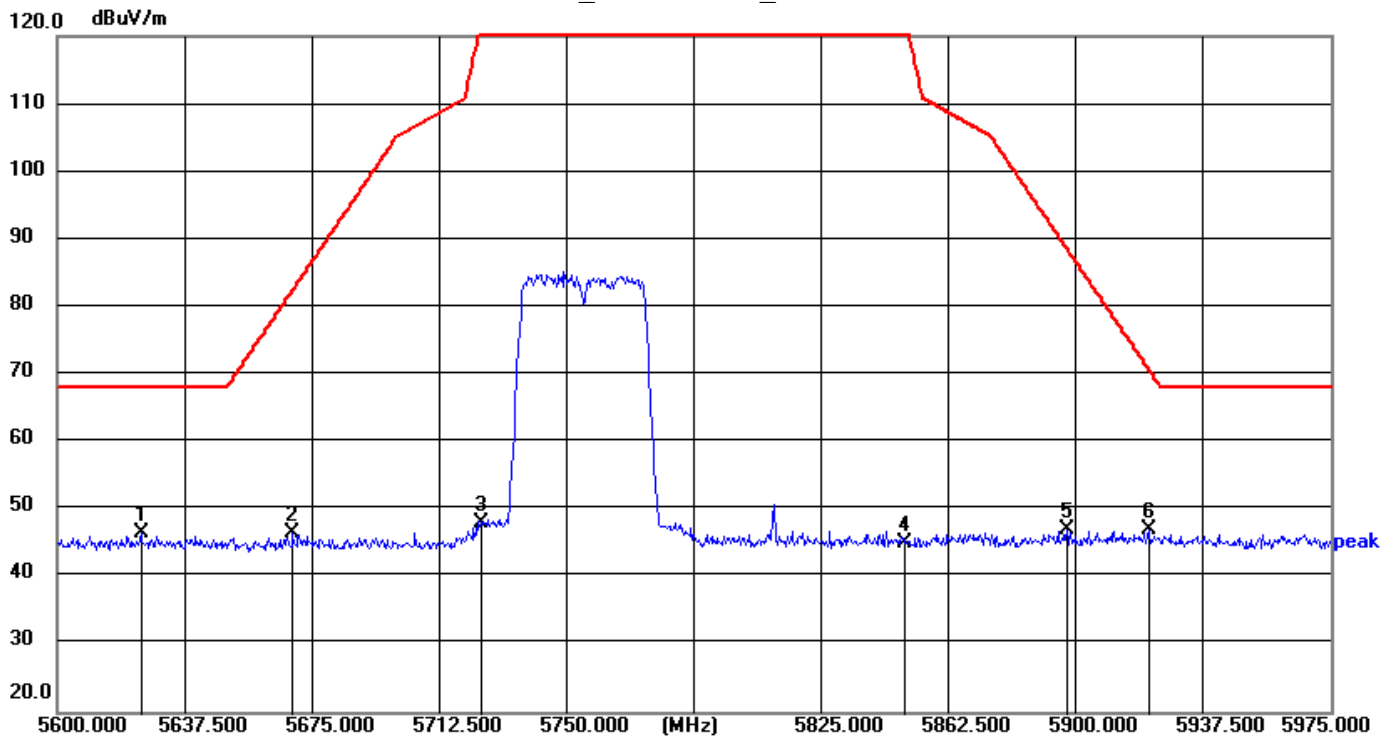

No.	Frequency (MHz)	Reading (dBuV)	Factor (dB/m)	Level (dBuV/m)	Limit (dBuV/m)	Margin (dB)	Det.
1 *	5624.750	51.24	-4.69	46.55	68.20	-21.65	peak
2	5669.375	51.16	-4.67	46.49	82.54	-36.05	peak
3	5725.000	52.78	-4.57	48.21	122.20	-73.99	peak
4	5850.000	49.23	-4.10	45.13	122.20	-77.07	peak
5	5897.375	51.03	-3.89	47.14	88.64	-41.50	peak
6	5921.375	50.91	-3.92	46.99	70.88	-23.89	peak

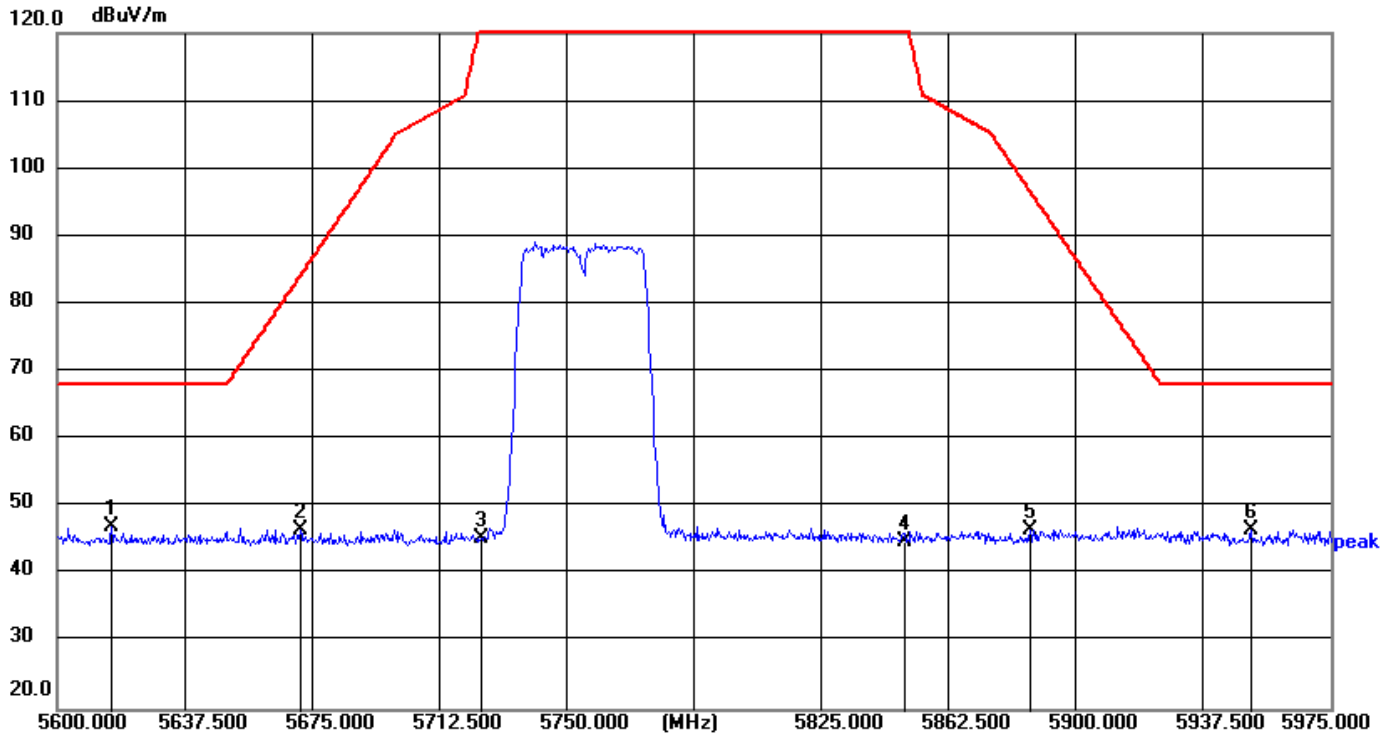

No.	Frequency (MHz)	Reading (dBuV)	Factor (dB/m)	Level (dBuV/m)	Limit (dBuV/m)	Margin (dB)	Det.
1 *	5616.125	51.71	-4.69	47.02	68.20	-21.18	peak
2	5671.625	51.40	-4.68	46.72	84.20	-37.48	peak
3	5725.000	49.83	-4.57	45.26	122.20	-76.94	peak
4	5850.000	48.96	-4.10	44.86	122.20	-77.34	peak
5	5886.500	50.64	-3.94	46.70	96.69	-49.99	peak
6	5951.375	50.56	-3.97	46.59	68.20	-21.61	peak

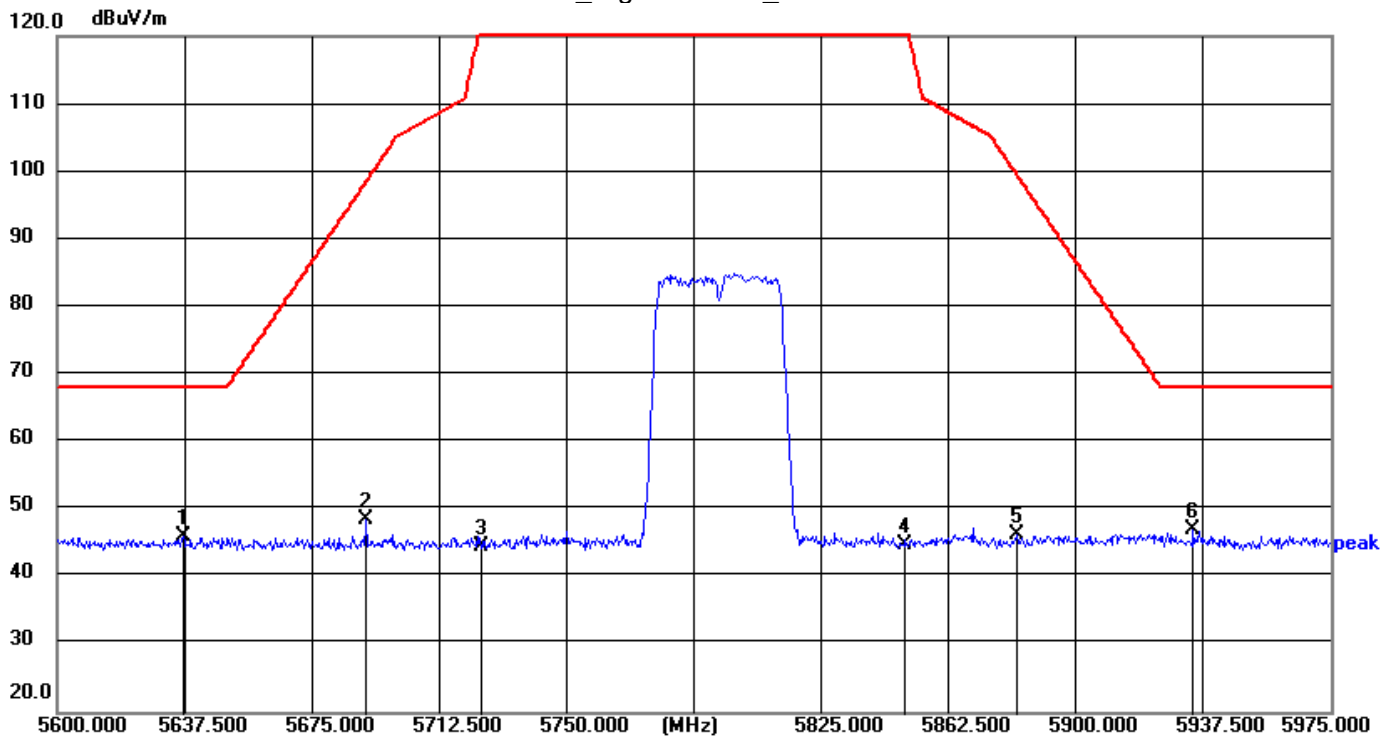

No.	Frequency (MHz)	Reading (dBuV)	Factor (dB/m)	Level (dBuV/m)	Limit (dBuV/m)	Margin (dB)	Det.
1	5637.125	50.73	-4.68	46.05	68.20	-22.15	peak
2	5691.125	53.28	-4.66	48.62	98.63	-50.01	peak
3	5725.000	49.08	-4.57	44.51	122.20	-77.69	peak
4	5850.000	48.87	-4.10	44.77	122.20	-77.43	peak
5	5882.750	50.26	-3.96	46.30	99.47	-53.17	peak
6 *	5934.500	50.92	-3.93	46.99	68.20	-21.21	peak

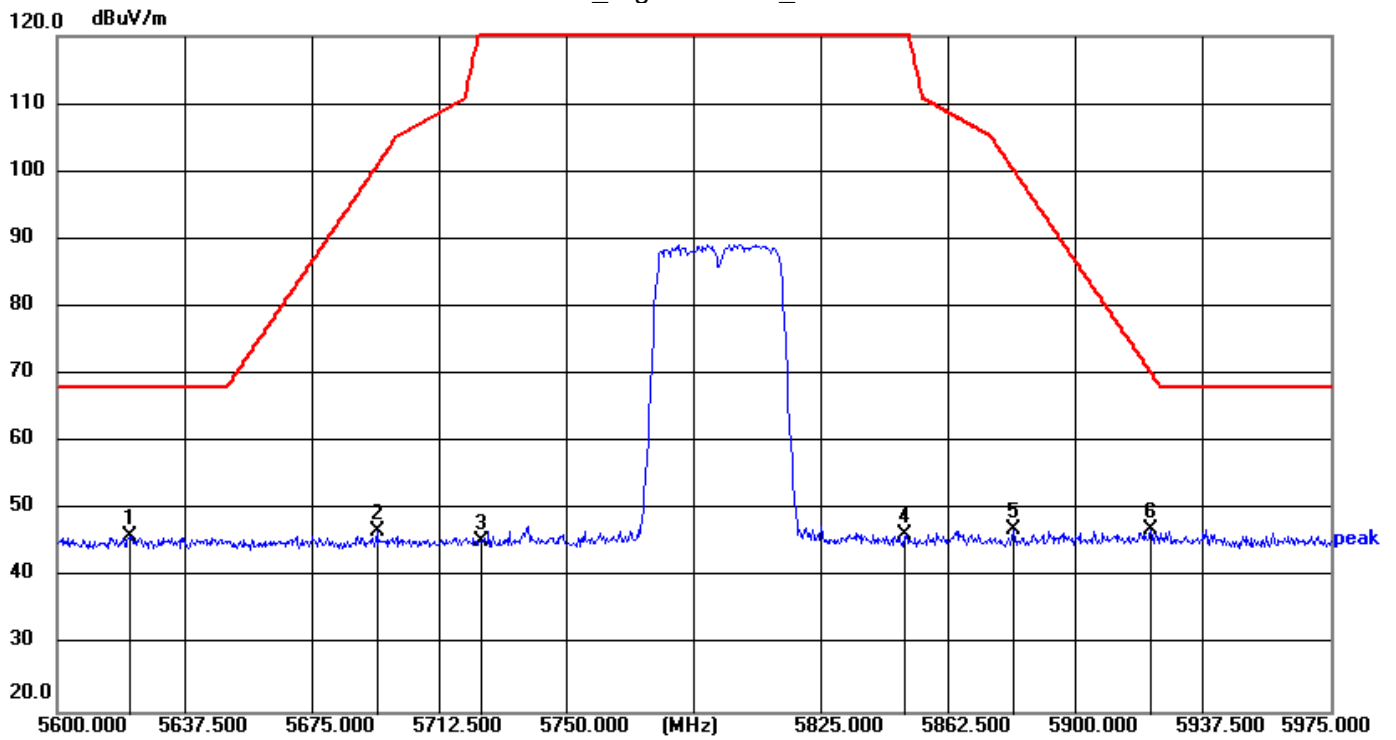

No.	Frequency (MHz)	Reading (dBuV)	Factor (dB/m)	Level (dBuV/m)	Limit (dBuV/m)	Margin (dB)	Det.
1 *	5621.375	50.72	-4.70	46.02	68.20	-22.18	peak
2	5694.125	51.50	-4.66	46.84	100.85	-54.01	peak
3	5725.000	49.98	-4.57	45.41	122.20	-76.79	peak
4	5850.000	50.43	-4.10	46.33	122.20	-75.87	peak
5	5881.625	51.06	-3.96	47.10	100.30	-53.20	peak
6	5922.125	50.98	-3.91	47.07	70.33	-23.26	peak

802.11ax80_Horizontal

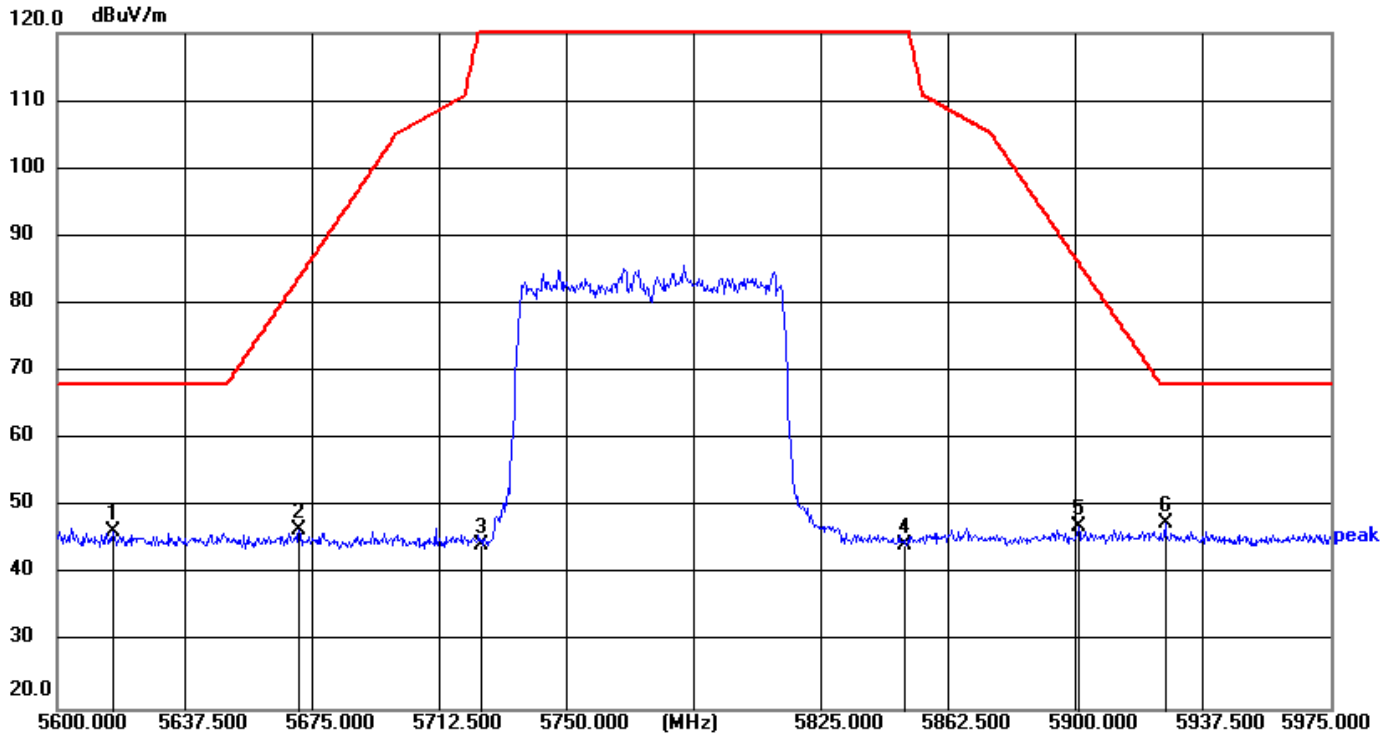

No.	Frequency (MHz)	Reading (dBuV)	Factor (dB/m)	Level (dBuV/m)	Limit (dBuV/m)	Margin (dB)	Det.
1	5616.500	51.12	-4.69	46.43	68.20	-21.77	peak
2	5671.250	51.31	-4.68	46.63	83.92	-37.29	peak
3	5725.000	49.07	-4.57	44.50	122.20	-77.70	peak
4	5850.000	48.38	-4.10	44.28	122.20	-77.92	peak
5	5900.750	51.10	-3.88	47.22	86.14	-38.92	peak
6 *	5926.250	51.52	-3.93	47.59	68.20	-20.61	peak

802.11ax80_Vertical

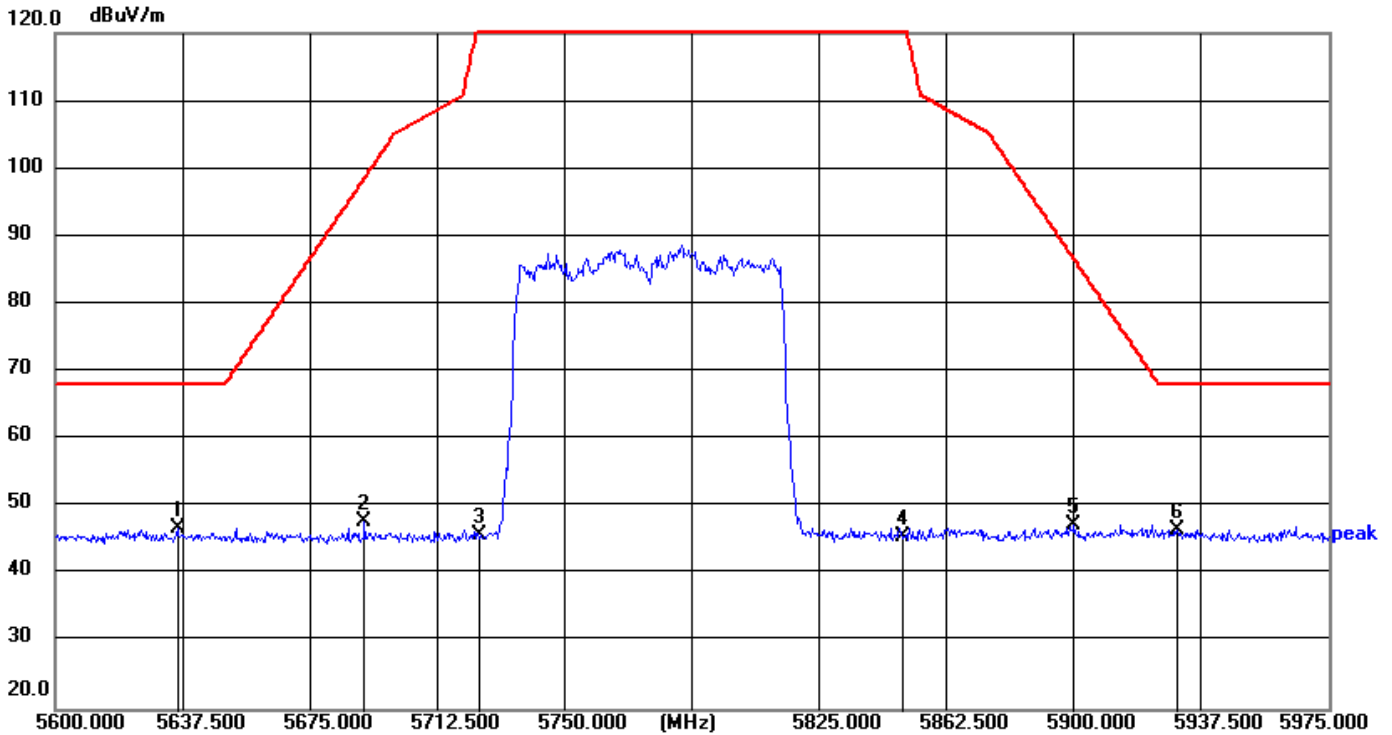

No.	Frequency (MHz)	Reading (dBuV)	Factor (dB/m)	Level (dBuV/m)	Limit (dBuV/m)	Margin (dB)	Det.
1 *	5636.000	51.64	-4.68	46.96	68.20	-21.24	peak
2	5691.125	52.44	-4.66	47.78	98.63	-50.85	peak
3	5725.000	50.34	-4.57	45.77	122.20	-76.43	peak
4	5850.000	49.75	-4.10	45.65	122.20	-76.55	peak
5	5900.000	51.14	-3.88	47.26	86.70	-39.44	peak
6	5930.375	50.62	-3.93	46.69	68.20	-21.51	peak

Remarks:

- 1). $Margin = Emission\ Level - Limit$
- 2). $Emission\ Level = Reading + Factor$
- 3). $Factor = Antenna\ Factor + Cable\ Loss - Pre-amplifier$
- 4). Worst case data at 6Mbps at IEEE 802.11a; MCS0 at IEEE 802.11n HT20, IEEE 802.11n HT40, IEEE 802.11ac VHT20, IEEE 802.11ac VHT40, IEEE 802.11ac VHT80; IEEE 802.11ax HE20, IEEE 802.11ax HE40, IEEE 802.11ax HE80
- 5) All the modes have been tested and recorded worst mode in the report. (IEEE 802.11ax)

6.8 Power Line Conducted Emissions

6.8.1 Standard requirement:

According to §15.207 (a): For an intentional radiator which is designed to be connected to the public utility (AC) power line, the radio frequency voltage that is conducted back onto the AC power line on any frequency or frequencies within the band 150 kHz to 30 MHz shall not exceed 250 microvolts (The limit decreases linearly with the logarithm of the frequency in the range 0.15 MHz to 0.50 MHz). The limits at specific frequency range is listed as follows:

Frequency Range (MHz)	Limits (dB μ V)	
	Quasi-peak	Average
0.15 to 0.50	66 to 56	56 to 46
0.50 to 5	56	46
5 to 30	60	50

* Decreasing linearly with the logarithm of the frequency

6.8.2 Test Setup Layout

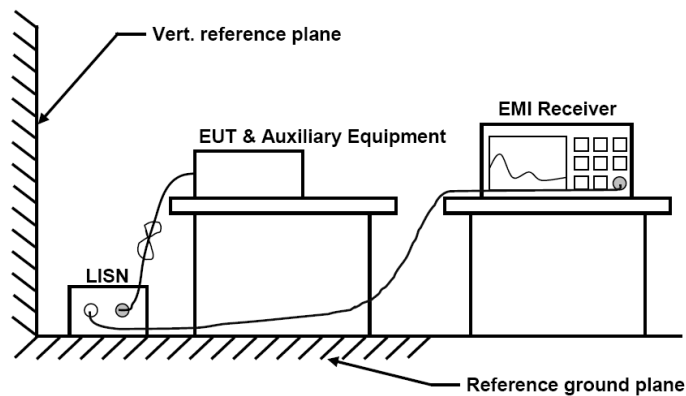

6.8.3 EUT Operation during Test

The EUT was programmed to be in continuously transmitting mode.

6.8.4 Test Procedures

The transmitter output is connected to EMI receiver. The resolution bandwidth is set to 9 kHz. The video bandwidth is set to 30 kHz, Sweep time=Auto

The spectrum from 150 kHz to 30MHz is investigated with the transmitter set to the lowest, middle, and highest channels.

6.8.5 Test result

PASS

The test data please refer to following page.

Measurement data:

AC Conducted Emission of charge from Adapter mode @ AC 120V/60Hz @ (IEEE 802.11ac(VHT40)) (worst case)

Model name:	DMP-A10	Test Date :	2024-10-09
Temperature:	25.8° C	Relative Humidity:	52.5%
ATM Pressure:	101 kPa	Test Result:	<input checked="" type="checkbox"/> Pass <input type="checkbox"/> Fail
Phase :	Line		

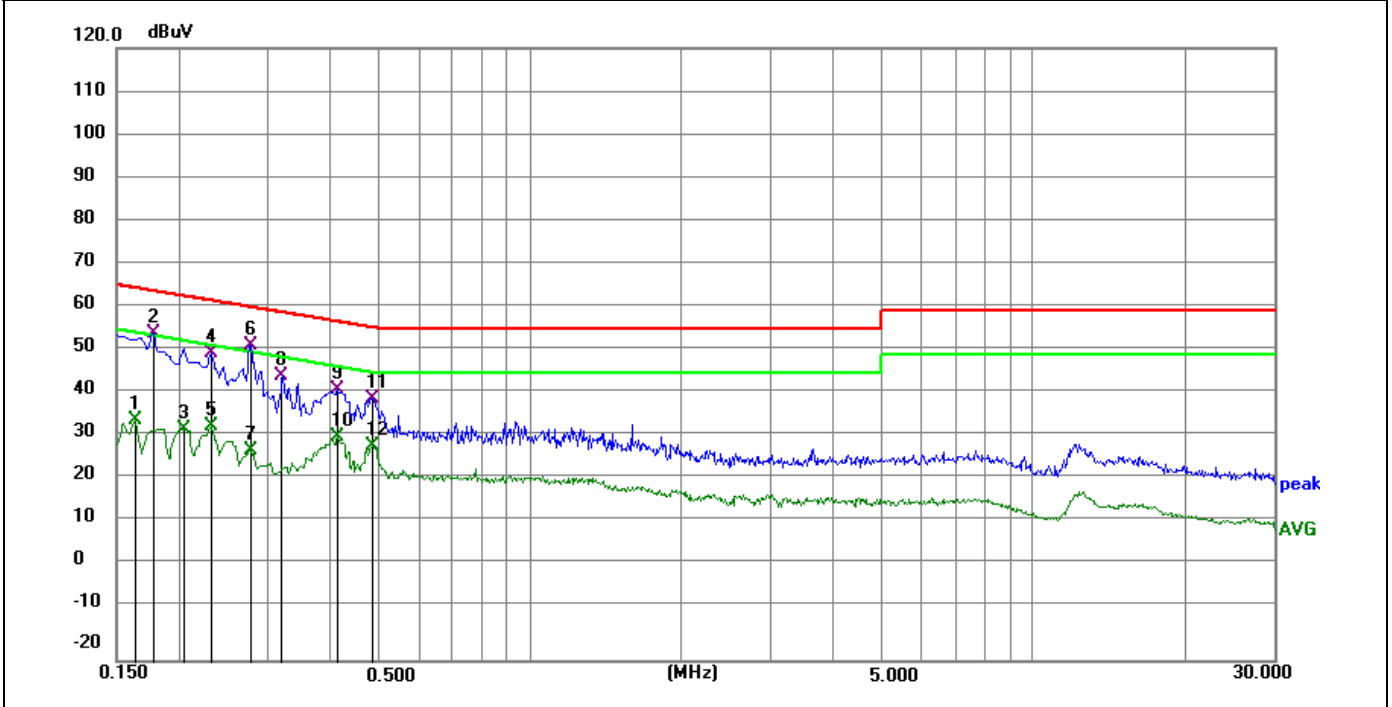

Remark: Correct Factor = Insertion loss of LISN + Cable loss + Insertion loss of Pulse Limiter;
 Measurement Result = Reading Level +Correct Factor;
 Margin = Measurement Result- Limit;

No.	Frequency (MHz)	Reading (dBuV)	Correct (dB)	Result (dBuV)	Limit (dBuV)	Margin (dB)	Remark
1	0.1635	24.43	10.67	35.10	55.28	-20.18	AVG
2	0.1770	44.24	10.68	54.92	64.63	-9.71	QP
3	0.2040	22.32	10.70	33.02	53.45	-20.43	AVG
4	0.2310	39.65	10.70	50.35	62.41	-12.06	QP
5	0.2310	22.86	10.70	33.56	52.41	-18.85	AVG
6	0.2760	41.52	10.70	52.22	60.94	-8.72	QP
7	0.2760	17.44	10.70	28.14	50.94	-22.80	AVG
8	0.3209	34.36	10.70	45.06	59.68	-14.62	QP
9	0.4110	31.15	10.69	41.84	57.63	-15.79	QP
10	0.4110	20.43	10.69	31.12	47.63	-16.51	AVG
11	0.4830	29.27	10.69	39.96	56.29	-16.33	QP
12	0.4830	18.58	10.69	29.27	46.29	-17.02	AVG

Model name:	DMP-A10	Test Date :	2024-10-09
Temperature:	25.8° C	Relative Humidity:	52.5%
ATM Pressure:	101 kPa	Test Result:	<input checked="" type="checkbox"/> Pass <input type="checkbox"/> Fail
Phase :	Neutral		

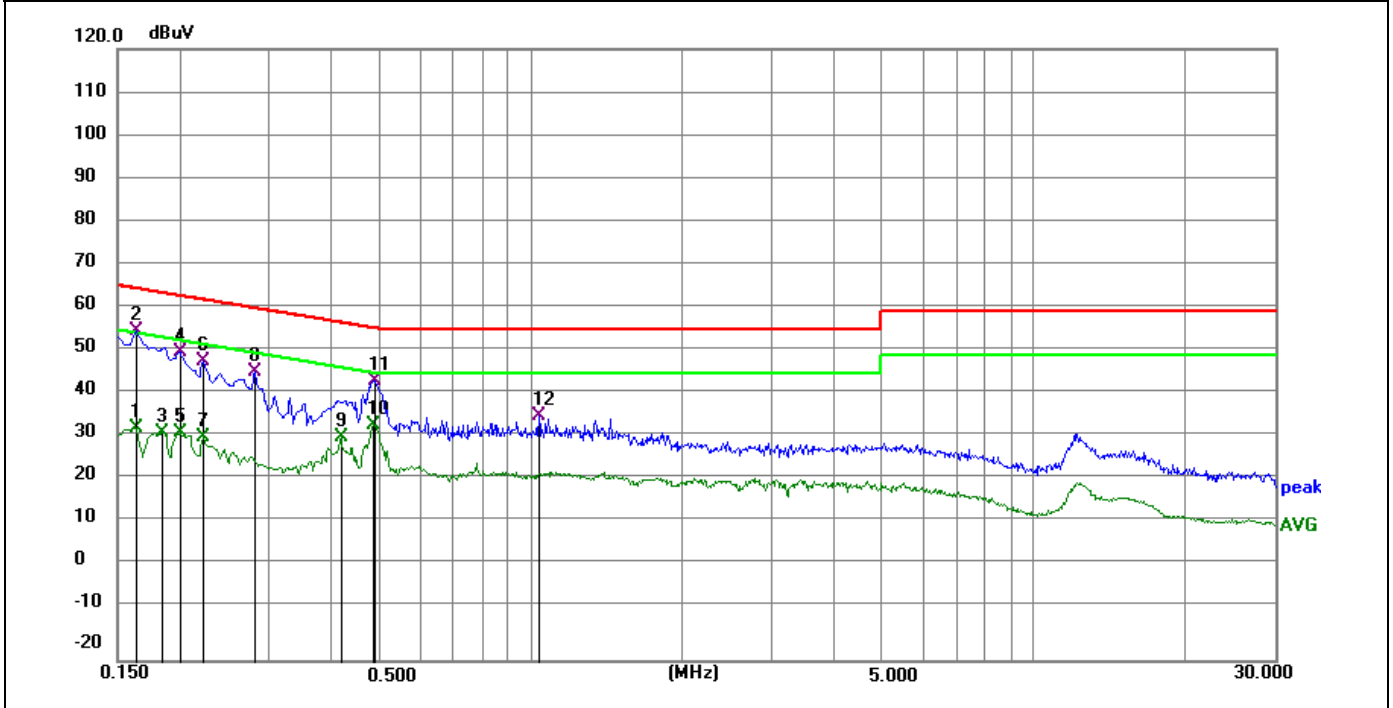

Remark: Correct Factor = Insertion loss of LISN + Cable loss + Insertion loss of Pulse Limiter;
 Measurement Result = Reading Level +Correct Factor;
 Margin = Measurement Result- Limit;

No.	Frequency (MHz)	Reading (dBuV)	Correct (dB)	Result (dBuV)	Limit (dBuV)	Margin (dB)	Remark
1	0.1632	22.63	10.67	33.30	55.30	-22.00	AVG
2	0.1635	45.04	10.67	55.71	65.28	-9.57	QP
3	0.1844	21.54	10.69	32.23	54.29	-22.06	AVG
4	0.1995	40.13	10.69	50.82	63.63	-12.81	QP
5	0.1995	21.49	10.69	32.18	53.63	-21.45	AVG
6	0.2220	38.01	10.69	48.70	62.74	-14.04	QP
7	0.2220	20.56	10.69	31.25	52.74	-21.49	AVG
8	0.2805	35.34	10.69	46.03	60.80	-14.77	QP
9	0.4154	20.51	10.69	31.20	47.54	-16.34	AVG
10	0.4830	23.48	10.69	34.17	46.29	-12.12	AVG
11	0.4874	33.33	10.69	44.02	56.21	-12.19	QP
12	1.0363	25.40	10.64	36.04	56.00	-19.96	QP

Notes:

1. An initial pre-scan was performed on the line and neutral lines with peak detector.
2. Quasi-Peak and Average measurement were performed at the frequencies with maximized peak emission.
3. If the average limit is met when using a quasi-peak detector receiver, the EUT shall be deemed to meet both limits and measurement with the average detector receiver is unnecessary.

6.9 Frequency Stability

6.9.1 Standard requirement:

According to FCC §15.407(g) “Manufacturers of U-NII devices are responsible for ensuring frequency stability such that an emission is maintained within the band of operation under all conditions of normal operation as specified in the users manual.”

According to FCC §2.1055(a) “The frequency stability shall be measured with variation of ambient temperature as follows:”

- (1) From -30° to $+50^{\circ}$ centigrade for all equipment except that specified in paragraphs (a) (2) and (3) of this section.
- (2) From -20° to $+50^{\circ}$ centigrade for equipment to be licensed for use in the Maritime Services under part 80 of this chapter, except for Class A, B, and S Emergency Position Indicating Radiobeacons (EPIRBS), and equipment to be licensed for use above 952 MHz at operational fixed stations in all services, stations in the Local Television Transmission Service and Point-to-Point Microwave Radio Service under part 21 of this chapter, equipment licensed for use aboard aircraft in the Aviation Services under part 87 of this chapter, and equipment authorized for use in the Family Radio Service under part 95 of this chapter.
- (3) From 0° to $+50^{\circ}$ centigrade for equipment to be licensed for use in the Radio Broadcast Services under part 73 of this chapter.

6.9.2 Measuring Instruments and Setting:

Please refer to equipment list in this report.

6.9.3 Test Procedures

The equipment under test was connected to an external AC or DC power supply and input rated voltage. RF output was connected to a frequency counter or spectrum analyzer via feed through attenuators. The EUT was placed inside the temperature chamber. Set the spectrum analyzer RBW low enough to obtain the desired frequency resolution and measure EUT 20 degree operating frequency as reference frequency. Turn EUT off and set the chamber temperature to -30 degree. After the temperature stabilized for approximately 30 minutes recorded the frequency. Repeat step measure wuth 10 degree increased per stage until the highest temperature of +50 degree reached.

6.9.4 Test Setup Layout

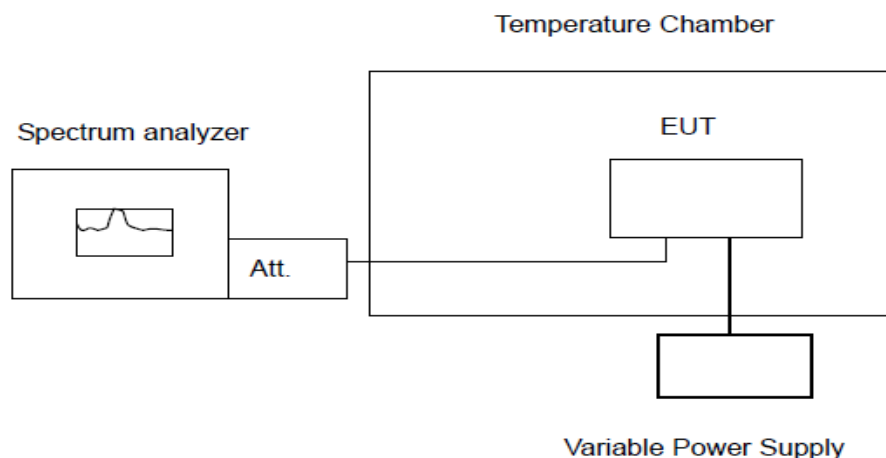

6.9.5 EUT Operation during Test

The EUT was programmed to be in continuously transmitting mode.

6.9.6 Test result

PASS

Please refer to Appendix D

Remark:

1. *Measured all conditions and recorded worst case.*

7 Test Setup Photographs of EUT

Please refer to separated files for Test Setup Photos of the EUT.

8 External Photographs of EUT

Please refer to separated files for External Photos of the EUT.

9 Internal Photographs of EUT

Please refer to separated files for Internal Photos of the EUT.

-----End-----