

TEST REPORT

Client Information:

Applicant: Shenzhen Eversolo Audio Technology Co., Ltd.
Applicant add.: Room 1302, Floor 13, Chentian R&D Building, No. 50, Baotian First Road, Chentian Community, Xixiang Avenue, Baoan District, Shenzhen, China
Manufacturer: Shenzhen Hengshengwei Electronics Co., Ltd.
Manufacturer add.: Room202, Building B, Hengmingzhulindustrial Park, Lingguosuo, Taoyuan Community, Xixiang Street, Baoan District, Shenzhen, China

Product Information:

Product Name: Hi-End Music Streamer
Model No.: DMP-A10
Serial Model: N/A
Brand Name: Eversolo
Test samples.: AiTSZ-240921007-1
FCC ID: 2A8D2-DMP-A10

Applicable standards: FCC CFR Title 47 Part 15 Subpart E Section 15.407

Prepared By:

Guangdong Asia Hongke Test Technology Limited

B1/F, Building 11, Junfeng Industrial Park, Chongqing Road, Heping Community, Fuhai Street, Bao'an District, Shenzhen, Guangdong, China

Tel.: +86 0755-230967639 Fax.: +86 0755-230967639

Date of Receipt: Sept. 28, 2024 Date of Test: Sept 28, 2024 ~ Oct. 13, 2024

Date of Issue: Oct. 13, 2024 Test Result: Pass

This device described above has been tested by Guangdong Asia Hongke Test Technology Limited and the test results show that the equipment under test (EUT) is in compliance with the FCC requirements. And it is applicable only to the tested sample identified in the report.

Note: This report shall not be reproduced except in full, without the written approval of Guangdong Asia Hongke Test Technology Limited, this document may be altered or revised by Guangdong Asia Hongke Test Technology Limited, personal only, and shall be noted in the revision of the document. This test report must not be used by the client to claim product endorsement.

Reviewed by:

Leon Yi

Leon.yi

Approved by:

Sean She

Sean She



1 Contents

	Page
COVER PAGE	
1 CONTENTS	2
2 TEST SUMMARY	5
2.1 Statement of the Measurement Uncertainty	5
2.2 Measurement Uncertainty	5
3 TEST FACILITY	6
3.1 Deviation from standard	6
3.2 Abnormalities from standard conditions	6
3.3 Test Location	6
4 GENERAL INFORMATION	7
4.1 Test frequencies	8
4.2 EUT Peripheral List	8
4.3 Test Peripheral List	8
4.4 TEST METHODOLOGY	9
4.5 Description of Test Modes	10
5 EQUIPMENT USED DURING TEST	12
6 TEST RESULTS AND MEASUREMENT DATA	13
6.1 Antenna requirement	13
6.1.1 Standard requirement:	13
6.1.2 EUT Antenna:	13
6.2 On Time and Duty Cycle	14
6.2.1 Standard requirement:	14
6.2.2 Measuring Instruments and Setting:	14
6.2.3 Test Procedures	14
6.2.4 Test Setup Layout	14
6.2.5 EUT Operation during Test	14
6.2.6 Test result	14
6.3 Maximum Conducted Output Power Measurement	15
6.3.1 Standard requirement:	15
6.3.2 Measuring Instruments:	15
6.3.3 Test Procedures:	15
6.3.4 Test Setup Layout	16
6.3.5 EUT Operation during Test	16
6.3.6 Test result	16
6.4 26dB Bandwidth Measurement	18
6.4.1 Standard requirement:	18
6.4.2 Measuring Instruments:	18
6.4.3 Test Procedures	18

6.4.4	Test Setup Layout	18
6.4.5	EUT Operation during Test	18
6.4.6	Test result	18
6.5	Power Spectral Density	20
6.5.1	Standard requirement:	20
6.5.2	Measuring Instruments and Setting:	20
6.5.3	Test Procedures	20
6.5.4	Test Setup Layout	20
6.5.5	EUT Operation during Test	20
6.5.6	Test result	20
6.6	Radiated Emissions and Radiation Restricted band Measurement	22
6.6.1	Standard requirement:	22
6.6.2	Measuring Instruments and Setting:	23
6.6.3	Test Procedures	23
6.6.4	Test Setup Layout	26
6.6.5	EUT Operation during Test	27
6.6.6	Test result	27
6.7	Power Line Conducted Emissions	36
6.7.1	Standard requirement:	36
6.7.2	Test Setup Layout	36
6.7.3	Test Procedures	36
6.7.4	EUT Operation during Test	36
6.7.5	Test result	36
6.8	Frequency Stability	39
6.8.1	Standard requirement:	39
6.8.2	Measuring Instruments and Setting:	39
6.8.3	Test Procedures	39
6.8.4	Test Setup Layout	39
6.8.5	EUT Operation during Test	39
6.8.6	Test result	40
7	TEST SETUP PHOTOGRAPHS OF EUT.....	41
8	EXTERNAL PHOTOGRAPHS OF EUT.....	41
9	INTERNAL PHOTOGRAPHS OF EUT	41



Revision History

Revision	Issue Date	Revisions	Revised By
00	Oct. 13, 2024	Initial Issue	Sean She

2 Test Summary

Test Item	Section in CFR 47	Result
/	On Time and Duty Cycle	/
§15.407(a)	Maximum Conducted Output Power	Pass
§15.407(a)	Power Spectral Density	Pass
§15.407(a)	26dB Bandwidth	Pass
§15.209 §15.407(b)	Radiated Emissions	Pass
§15.205	Emissions at Restricted Band	Pass
§15.407(g)	Frequency Stability	Pass
§15.207(a)	Power Line Conducted Emissions	Pass
§15.203	Antenna Requirements	Pass
§2.1093&§2.1091	RF Exposure	Pass*

Note

1. Test according to ANSI C63.10:2013.
2. The measurement uncertainty is not included in the test result.
3. “*” Test results in other test report (RF Exposure Evaluation Report)

2.1 Statement of the Measurement Uncertainty

The data and results referenced in this document are true and accurate. The reader is cautioned that there may be errors within the calibration limits of the equipment and facilities. The measurement uncertainty was calculated for all measurements listed in this test report acc. To CISPR 16 – 4 “Specification for radio disturbance and immunity measuring apparatus and methods – Part 4: Uncertainty in EMC Measurements” and is documented in the AiT quality system acc. To DIN EN ISO/IEC 17025. Furthermore, component and process variability of devices similar to that tested may result in additional deviation. The manufacturer has the sole responsibility of continued compliance of the device.

2.2 Measurement Uncertainty

Test Item	Frequency Range	Measurement Uncertainty	Notes
Radiated Emission	0.009MHz-30MHz	3.10dB	(1)
Radiated Emission	30MHz-1GHz	3.75dB	(1)
Radiated Emission	1GHz-18GHz	3.88dB	(1)
Radiated Emission	18GHz-40GHz	3.88dB	(1)
AC Power Line Conducted Emission	0.15MHz ~ 30MHz	1.20dB	(1)

Note (1): The measurement uncertainty is for coverage factor of k=2 and a level of confidence of 95%.

3 Test Facility

The test facility is recognized, certified or accredited by the following organizations:

FCC-Registration No.: 251906 Designation Number: CN1376

Guangdong Asia Hongke Test Technology Limited has been registered and fully described in a report filed with the (FCC) Federal Communications Commission. The acceptance letter from the FCC is maintained in our files.

IC —Registration No.: 31737 CAB identifier: CN0165

The 3m Semi-anechoic chamber of Guangdong Asia Hongke Test Technology Limited has been registered by Certification and Engineering Bureau of Industry Canada for radio equipment testing with Registration No.: 31737

A2LA-Lab Cert. No.: 7133.01

Guangdong Asia Hongke Test Technology Limited has been accredited by A2LA for technical competence in the field of electrical testing, and proved to be in compliance with ISO/IEC 17025: 2017 General Requirements for the Competence of Testing and Calibration Laboratories and any additional program requirements in the identified field of testing.

3.1 Deviation from standard

None

3.2 Abnormalities from standard conditions

None

3.3 Test Location

Guangdong Asia Hongke Test Technology Limited

Address: B1/F, Building 11, Junfeng Industrial Park, Chongqing Road, Heping Community, Fuhai Street, Bao'an District, Shenzhen, Guangdong, China

Tel.: +86 0755-230967639 Fax.: +86 0755-230967639

4 General Information

EUT Name:	Hi-End Music Streamer			
Model No:	DMP-A10			
Brand Name:	Eversolo			
Serial Model:	N/A			
Sample(s) Status:	Engineer sample			
Operation frequency:	Band	Mode	Frequency Range(MHz)	Number of channels
	U-NII Band I	IEEE 802.11a	5180-5240	4
		IEEE 802.11n/ac/ax 20MHz	5180-5240	4
		IEEE 802.11n/ac/ax 40MHz	5190-5230	2
		IEEE 802.11ac/ax 80MHz	5210	1
Modulation Technology:	OFDM			
Modulation Type	IEEE 802.11a/n/ac/ax: OFDM(64QAM, 16QAM, QPSK, BPSK)			
Antenna Type:	Stick Antenna			
Antenna gain:	3.91dBi			
H/W No.:	N/A			
S/W No.:	N/A			
Adapter:	Input: 100-240V 50/60Hz 0.4A Output: 12V=2.5A 30W			
Model different:	N/A			
Note:	For a more detailed features description, please refer to the manufacturer's specifications or the User's Manual.			

4.1 Test frequencies

EUT channels and frequencies list:

Channel list for 802.11a/n(HT20)/ac(VHT20) /ax(HE20)							
Channel	Frequency	Channel	Frequency	Channel	Frequency	Channel	Frequency
36	5180MHz	40	5200MHz	44	5220MHz	48	5240MHz

Channel list for 802.11n(HT40)/ac(VHT40) /ax(HE40)							
Channel	Frequency	Channel	Frequency	Channel	Frequency	Channel	Frequency
38	5190MHz	46	5230MHz				

Channel list for 802.11ac(VHT80) /ax(HE80)							
Channel	Frequency	Channel	Frequency	Channel	Frequency	Channel	Frequency
42	5210MHz						

4.2 EUT Peripheral List

No.	Equipment	Manufacturer	EMC Compliance	Model No.	Serial No.	Power cord	Signal cord
1	N/A	N/A	N/A	N/A	N/A	N/A	N/A

4.3 Test Peripheral List

No.	Equipment	Manufacturer	EMC Compliance	Model No.	Serial No.	Power cord	Signal cord
1	Notebook	DELL	VOSTRO.3 800	DELL	N/A	N/A	N/A
2	USB Cable	N/A	N/A	100cm	N/A	N/A	N/A

4.4 TEST METHODOLOGY

All measurements contained in this report were conducted with ANSI C63.10-2013, American National Standard of Procedures for Compliance Testing of Unlicensed Wireless Devices.

The radiated testing was performed at an antenna-to-EUT distance of 3 meters. All radiated and conducted emissions measurement was performed at Guangdong Asia Hongke Test Technology Limited

4.4.1 EUT Configuration

The EUT configuration for testing is installed on RF field strength measurement to meet the Commissions requirement and operating in a manner that intends to maximize its emission characteristics in a continuous normal application.

4.4.2 EUT Exercise

The EUT was operated in the engineering mode to fix the TX frequency that was for the purpose of the measurements.

According to FCC's request, Test Procedure 789033 D02 General UNII Test Procedures New Rules v01r03 and KDB 662911 D01 Multiple Transmitter Output v02r01 is required to be used for this kind of FCC 15.407 UII device.

According to its specifications, the EUT must comply with the requirements of the Section 15.203, 15.205, 15.207, 15.209 and 15.407 under the FCC Rules Part 15 Subpart E

4.4.3 General Test Procedures

Conducted Emissions

The EUT is placed on the turntable, which is 0.8 m above ground plane. According to the requirements in Section 6.2.1 of ANSI C63.10-2013 Conducted emissions from the EUT measured in the frequency range between 0.15 MHz and 30MHz using Quasi-peak and average detector modes.

Radiated Emissions

The EUT is placed on a turn table, which is 0.8 m above ground plane. The turntable shall rotate 360 degrees to determine the position of maximum emission level. EUT is set 3m away from the receiving antenna, which varied from 1m to 4m to find out the highest emission. And also, each emission was to be maximized by changing the polarization of receiving antenna both horizontal and vertical. In order to find out the maximum emissions, exploratory radiated emission measurements were made according to the requirements in Section 6.3 of ANSI C63.10-2013.

4.5 Description of Test Modes

The EUT has been tested under operating condition.

This test was performed with EUT in X, Y, Z position and the worst case was found when EUT in X position.

AC main conducted emission pre-test voltage at both AC 120V/60Hz and AC 240V/50Hz, recorded worst case;

AC main conducted emission pre-test at charge from power adapter modes, recorded worst case;

Worst-case mode and channel used for 9 KHz-1000 MHz radiated emissions was the mode and channel with the highest output power, that was determined to be IEEE 802.11ac VHT20 mode (HCH).

Worst-Case data rates were utilized from preliminary testing of the Chipset, worst-case data rates used during the testing are as follows:

- IEEE 802.11a Mode: 6 Mbps, OFDM.
- IEEE 802.11ac VHT20 Mode: MCS0
- IEEE 802.11n HT20 Mode: MCS0, OFDM.
- IEEE 802.11ac VHT40 Mode: MCS0, OFDM.
- IEEE 802.11n HT40 Mode: MCS0, OFDM.
- IEEE 802.11ac VHT80 Mode: MCS0, OFDM.
- IEEE 802.11ax HE20 Mode: MCS0, OFDM.
- IEEE 802.11ax HE40 Mode: MCS0, OFDM.
- IEEE 802.11ax HE80 Mode: MCS0, OFDM.

In section 15.31(m), regards to the operating frequency range over 10 MHz, the Lowest frequency, the middle frequency, and the highest frequency of channel were selected to perform the test, and the selected channel see below:

Transmitting mode	Keep the EUT in continuously transmitting mode.					
Test software:	*##9646633##*					
Frequency	5180 MHz	5200 MHz	5240 MHz			
Parameters(802.11a)	Default	Default	Default			
Parameters(802.11n20)	Default	Default	Default			
Parameters(802.11ac20)	Default	Default	Default			
Parameters(802.11ax20)	Default	Default	Default			
Frequency	5190 MHz	5230 MHz				
Parameters(802.11n40)	Default	Default				
Parameters(802.11ac40)	Default	Default				
Parameters(802.11ax40)	Default	Default				
Frequency	5210 MHz					
Parameters(802.11ac80)	Default					
Parameters(802.11ax80)	Default					

Antenna & Bandwidth

Antenna	Chain 1 (ANT1)			Chain 2 (ANT2)			Simultaneously
Bandwidth Mode	20MHz	40MHz	80MHz	20MHz	40MHz	80MHz	/
IEEE 802.11a	<input checked="" type="checkbox"/>	<input type="checkbox"/>	<input type="checkbox"/>	<input checked="" type="checkbox"/>	<input type="checkbox"/>	<input type="checkbox"/>	<input type="checkbox"/>
IEEE 802.11n	<input checked="" type="checkbox"/>	<input checked="" type="checkbox"/>	<input type="checkbox"/>	<input checked="" type="checkbox"/>	<input checked="" type="checkbox"/>	<input type="checkbox"/>	<input type="checkbox"/>
IEEE 802.11ac	<input checked="" type="checkbox"/>	<input checked="" type="checkbox"/>	<input checked="" type="checkbox"/>	<input checked="" type="checkbox"/>	<input checked="" type="checkbox"/>	<input checked="" type="checkbox"/>	<input checked="" type="checkbox"/>
IEEE 802.11ax	<input checked="" type="checkbox"/>	<input checked="" type="checkbox"/>	<input checked="" type="checkbox"/>	<input checked="" type="checkbox"/>	<input checked="" type="checkbox"/>	<input checked="" type="checkbox"/>	<input checked="" type="checkbox"/>

5 Equipment Used during Test

No	Test Equipment	Manufacturer	Model No	Serial No	Cal. Date	Cal. Due Date
1	Spectrum Analyzer	R&S	FSV40	101470	2024.09.25	2025.09.24
2	Spectrum Analyzer	Keysight	N9020A	MY51280643	2024.09.25	2025.09.24
3	EMI Measuring Receiver	R&S	ESR	101660	2024.09.25	2025.09.24
4	Low Noise Pre-Amplifier	HP	HP8447E	1937A01855	2024.09.25	2025.09.24
5	Low Noise Pre-Amplifier	Tsj	MLA-0120-A02-34	2648A04738	2024.09.25	2025.09.24
6	Passive Loop	ETS	6512	00165355	2024.09.25	2025.09.24
7	TRILOG Super Broadband test Antenna	SCHWARZBECK	VULB9160	9160-3206	2024.08.28	2027.08.27
8	Broadband Horn Antenna	SCHWARZBECK	BBHA9120D	452	2024.08.28	2027.08.27
9	SHF-EHF Horn Antenna 15-40GHz	SCHWARZBECK	BBHA9170	BBHA9170367d	2024.08.28	2027.08.27
10	EMI Measuring Receiver	R&S	ESR	101160	2024.09.25	2025.09.24
11	LISN	SCHWARZBECK	NNLK 8129	8130179	2024.09.25	2025.09.24
12	Pulse Limiter	R&S	ESH3-Z2	102789	2024.09.25	2025.09.24
13	Pro.Temp&Humi.chamber	MENTEK	MHP-150-1C	MAA08112501	2024.09.25	2025.09.24
14	RF Automatic Test system	MW	MW100-RFCB	21033016	2024.09.25	2025.09.24
15	Signal Generator	Agilent	N5182A	MY50143009	2024.09.25	2025.09.24
16	Wideband Radio communication tester	R&S	CMW500	1201.0002K50	2024.09.25	2025.09.24
17	RF Automatic Test system	MW	MW100-RFCB	21033016	2024.09.25	2025.09.24
18	DC power supply	ZHAOXIN	RXN-305D-2	28070002559	N/A	N/A
19	RE Software	EZ	EZ-EMC_RE	Ver.AIT-03A	N/A	N/A
20	CE Software	EZ	EZ-EMC_CE	Ver.AIT-03A	N/A	N/A
21	RF Software	MW	MTS 8310	2.0.0.0	N/A	N/A
22	temporary antenna connector(Note)	NTS	R001	N/A	N/A	N/A

Note: The temporary antenna connector is soldered on the PCB board in order to perform conducted tests and this temporary antenna connector is listed in the equipment list.

6 Test results and Measurement Data

6.1 Antenna requirement

6.1.1 Standard requirement:

For intentional device, according to FCC 47 CFR Section 15.203:

An intentional radiator shall be designed to ensure that no antenna other than that furnished by the responsible party shall be used with the device. The use of a permanently attached antenna or of an antenna that uses a unique coupling to the intentional radiator, the manufacturer may design the unit so that a broken antenna can be replaced by the user, but the use of a standard antenna jack or electrical connector is prohibited

And according to FCC 47 CFR Section 15.407 (a), if transmitting antennas of directional gain greater than 6dBi are used, the power shall be reduced by the amount in dB that the directional gain of the antenna exceeds 6dBi.

According to § 15.203 & RSS-Gen, an intentional radiator shall be designed to ensure that no antenna other than that furnished by the responsible party shall be used with the device.

6.1.2 EUT Antenna:

The antenna is Stick Antenna, the best case gain of the antenna is 3.91dBi reference to the Internal photos for details

6.2 On Time and Duty Cycle

6.2.1 Standard requirement:

None; for reporting purpose only

6.2.2 Measuring Instruments and Setting:

Please refer to equipments list in this report. The following table is the setting of the spectrum analyser.

6.2.3 Test Procedures

- 1). Set the Centre frequency of the spectrum analyzer to the transmitting frequency;
- 2). Set the span=0MHz, RBW=8MHz, VBW=50MHz, Sweep time=10.13ms;
- 3). Detector = peak;
- 4). Trace mode = Single hold.

6.2.4 Test Setup Layout

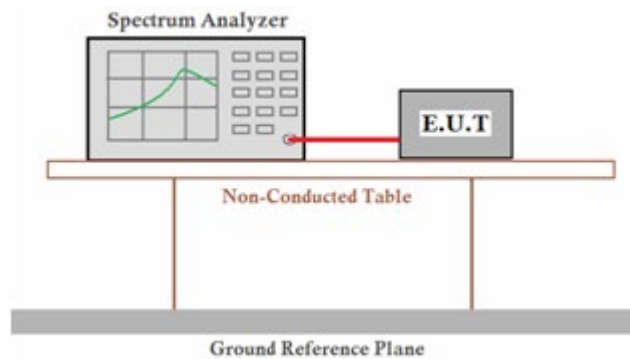

6.2.5 EUT Operation during Test

The EUT was programmed to be in continuously transmitting mode.

6.2.6 Test result

For reporting purpose only.

Please refer to Appendix D

6.3 Maximum Conducted Output Power Measurement

6.3.1 Standard requirement:

(1) For the band 5.15~5.25GHz

- (i) For an outdoor access point operating in the band 5.15-5.25 GHz, the maximum conducted output power over the frequency band of operation shall not exceed 1 W provided the maximum antenna gain does not exceed 6 dBi. If transmitting antennas of directional gain greater than 6 dBi are used, both the maximum conducted output power and the maximum power spectral density shall be reduced by the amount in dB that the directional gain of the antenna exceeds 6 dBi. The maximum e.i.r.p. at any elevation angle above 30 degrees as measured from the horizon must not exceed 125 mW (21 dBm).
- (ii) For an indoor access point operating in the band 5.15-5.25 GHz, the maximum conducted output power over the frequency band of operation shall not exceed 1 W provided the maximum antenna gain does not exceed 6 dBi. If transmitting antennas of directional gain greater than 6 dBi are used, both the maximum conducted output power and the maximum power spectral density shall be reduced by the amount in dB that the directional gain of the antenna exceeds 6 dBi.
- (iii) For fixed point-to-point access points operating in the band 5.15-5.25 GHz, the maximum conducted output power over the frequency band of operation shall not exceed 1 W. Fixed point-to-point U-NII devices may employ antennas with directional gain up to 23 dBi without any corresponding reduction in the maximum conducted output power. For fixed point-to-point transmitters that employ a directional antenna gain greater than 23 dBi, a 1dB reduction in maximum conducted output power is required for each 1 dB of antenna gain in excess of 23 dBi. Fixed, point-to-point operations exclude the use of point-to-multipoint systems, omnidirectional applications, and multiple collocated transmitters transmitting the same information. The operator of the U-NII device, or if the equipment is professionally installed, the installer, is responsible for ensuring that systems employing high gain directional antennas are used exclusively for fixed, point-to-point operations.
- (iv) For mobile and portable client devices in the 5.15-5.25 GHz band, the maximum conducted output power over the frequency band of operation shall not exceed 250 mW provided the maximum antenna gain does not exceed 6 dBi. If transmitting antennas of directional gain greater than 6 dBi are used, both the maximum conducted output power shall be reduced by the amount in dB that the directional gain of the antenna exceeds 6 dBi.

(2) For the band 5.25-5.35 GHz and 5.47-5.725 GHz

The maximum conducted output power over the frequency bands of operation shall not exceed the lesser of 250 mW or $11 \text{ dBm} + 10 \log B$, where B is the 26 dB emission bandwidth in megahertz. If transmitting antennas of directional gain greater than 6 dBi are used, both the maximum conducted output power and the maximum power spectral density shall be reduced by the amount in dB that the directional gain of the antenna exceeds 6 dBi.

6.3.2 Measuring Instruments:

Please refer to equipment's list in this report.

6.3.3 Test Procedures:

Method SA-2A uses rms detection with slow sweep with each spectrum bin averaging across ON and OFF times of the EUT transmissions, followed by duty cycle correction. The procedure for this method is as follows:

- a) Measure the duty cycle D of the transmitter output signal as described in 12.2.
- b) Set span to encompass the entire 26 dB EBW or 99% OBW of the signal.
- c) Set RBW = 1 MHz.

- d) Set VBW ≥ 3 MHz.
- e) Number of points in sweep $\geq [2 \times \text{span} / \text{RBW}]$. (This gives bin-to-bin spacing $\geq \text{RBW} / 2$, so that narrowband signals are not lost between frequency bins.)
- f) Manually set sweep time $\geq [10 \times (\text{number of points in sweep}) \times (\text{total ON/OFF period of the transmitted signal})]$.
- g) Set detector = RMS (power averaging).
- h) Perform a single sweep.
- i) Compute power by integrating the spectrum across the 26 dB EBW or 99% OBW of the signal using the instrument's band power measurement function with band limits set equal to the EBW or OBW band edges. If the instrument does not have a band power function, then sum the spectrum levels (in power units) at 1 MHz intervals extending across the 26 dB EBW of the spectrum.
- j) Add $[10 \log (1 / D)]$, where D is the duty cycle, to the measured power to compute the average power during the actual transmission times (because the measurement represents an average over both the ON and OFF times of the transmission). For example, add $[10 \log (1 / 0.25)] = 6$ dB if the duty cycle is 25%.

6.3.4 Test Setup Layout

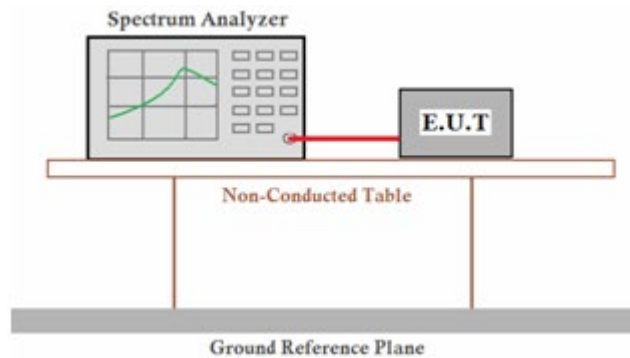

6.3.5 EUT Operation during Test

The EUT was programmed to be in continuously transmitting mode.

6.3.6 Test result

PASS

Please refer to Appendix D

Remark:

1. Measured output power at difference data rate for each mode and recorded worst case for each mode.
2. Test results including cable loss;
3. Worst case data at 6Mbps at IEEE 802.11a; MCS0 at IEEE 802.11n HT20, IEEE 802.11n HT40, IEEE 802.11ac VHT20, IEEE 802.11ac VHT40, IEEE 802.11ac VHT80; IEEE 802.11ax HE20, IEEE 802.11ax HE40, IEEE 802.11ax HE80;
4. Report conducted power = Measured conducted average power + Duty Cycle factor;
5. For power measurements on IEEE 802.11 devices;

Array Gain = 0 dB (i.e., no array gain) for $NANT \leq 4$;

Array Gain = 0 dB (i.e., no array gain) for channel widths ≥ 40 MHz for any NANT;

Array Gain = $5 \log(NANT/NSS)$ dB or 3 dB, whichever is less, for 20-MHz channel widths with $NANT \geq 5$

6.4 26dB Bandwidth Measurement

6.4.1 Standard requirement:

No restriction limits. But resolution bandwidth within band edge measurement is 1% of the 99% occupied bandwidth.

6.4.2 Measuring Instruments:

Please refer to equipment list in this report. The following table is the setting of the Spectrum Analyzer.

Spectrum Parameter	Setting
Attenuation	Auto
Span	> 26dB Bandwidth
Detector	Peak
Trace	Max Hold
Sweep Time	100ms

6.4.3 Test Procedures

1. The transmitter output (antenna port) was connected to the spectrum analyzer in peak hold mode.
2. The RBW = 1% - 3% of occupied bandwidth, VBW = 3*RBW;
3. Measured the spectrum width with power higher than 26dB below carrier.

6.4.4 Test Setup Layout

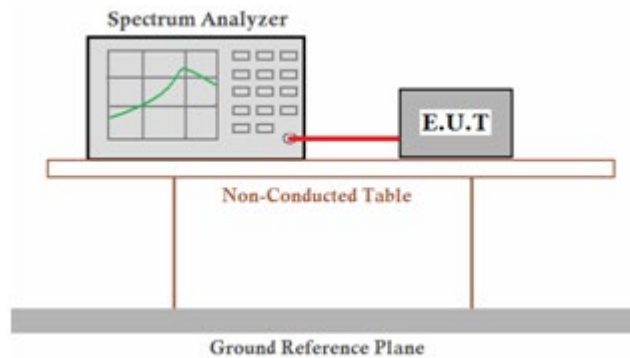

6.4.5 EUT Operation during Test

The EUT was programmed to be in continuously transmitting mode.

6.4.6 Test result

PASS

Please refer to Appendix D

Remark:

1. *Measured 26dB bandwidth at difference data rate for each mode and recorded worst case for each mode.*
2. *Test results including cable loss;*
3. *Worst case data at 6Mbps at IEEE 802.11a; MCS0 at IEEE 802.11n HT20, IEEE 802.11n HT40, IEEE 802.11ac VHT20, IEEE 802.11ac VHT40, IEEE 802.11ac VHT80; IEEE 802.11ax HE20, IEEE 802.11ax HE40, IEEE 802.11ax HE80;*

6.5 Power Spectral Density

6.5.1 Standard requirement:

For 5.15~5.25GHz

- (i) For an outdoor access point operating in the band 5.15 - 5.25 GHz, the maximum power spectral density shall not exceed 17 dBm in any 1 MHz band.note1
- (ii) For an indoor access point operating in the band 5.15 - 5.25 GHz, the maximum power spectral density shall not exceed 17 dBm in any 1 MHz band.note1
- (iii) For fixed point-to-point access points operating in the band 5.15 - 5.25 GHz, transmitters that employ a directional antenna gain greater than 23 dBi, a 1 dB reduction in maximum power spectral density is required for each 1 dB of antenna gain in excess of 23 dBi.
- (iv) For mobile and portable client devices in the 5.15 - 5.25 GHz band, the maximum power spectral density shall not exceed 11 dBm in any 1 MHz band. note1

Note1: If transmitting antennas of directional gain greater than 6 dBi are used, the peak power spectral density shall be reduced by the amount in dB that the directional gain of the antenna exceeds 6 dBi.

For the band 5.25-5.35 GHz and 5.47-5.725 GHz

The maximum power spectral density shall not exceed 11 dBm in any 1 megahertz band. If transmitting antennas of directional gain greater than 6 dBi are used, the peak power spectral density shall be reduced by the amount in dB that the directional gain of the antenna exceeds 6 dBi.

6.5.2 Measuring Instruments and Setting:

Please refer to equipment list in this report. The following table is the setting of Spectrum Analyzer.

6.5.3 Test Procedures

Refer to section 6.3.3 (except for i), the spectrograph cancels the channel power mode and changes to the spectrum mode.

6.5.4 Test Setup Layout

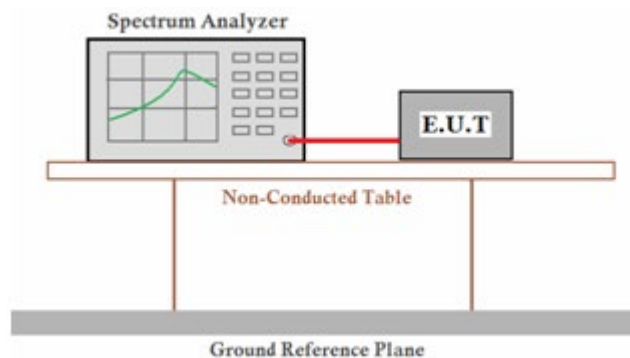

6.5.5 EUT Operation during Test

The EUT was programmed to be in continuously transmitting mode.

6.5.6 Test result

PASS

Please refer to Appendix D

Remark:

1. *Measured power spectrum density at difference data rate for each mode and recorded worst case for each mode.*
2. *Test results including cable loss;*
3. *Worst case data at 6Mbps at IEEE 802.11a; MCS0 at IEEE 802.11n HT20, IEEE 802.11n HT40, IEEE 802.11ac VHT20, IEEE 802.11ac VHT40, IEEE 802.11ac VHT80; IEEE 802.11ax HE20, IEEE 802.11ax HE40, IEEE 802.11ax HE80;*

Report conducted PSD = Measured conducted average power + Duty Cycle factor;

6.6 Radiated Emissions and Radiation Restricted band Measurement

6.6.1 Standard requirement:

15.205 (a) Except as shown in paragraph (d) of this section, only spurious emissions are permitted in any of the frequency bands listed below:

MHz	MHz	MHz	GHz
0.090-0.110	16.42-16.423	399.9-410	4.5-5.15
\1\ 0.495-0.505	16.69475-16.69525	608-614	5.35-5.46
2.1735-2.1905	16.80425-16.80475	960-1240	7.25-7.75
4.125-4.128	25.5-25.67	1300-1427	8.025-8.5
4.17725-4.17775	37.5-38.25	1435-1626.5	9.0-9.2
4.20725-4.20775	73-74.6	1645.5-1646.5	9.3-9.5
6.215-6.218	74.8-75.2	1660-1710	10.6-12.7
6.26775-6.26825	108-121.94	1718.8-1722.2	13.25-13.4
6.31175-6.31225	123-138	2200-2300	14.47-14.5
8.291-8.294	149.9-150.05	2310-2390	15.35-16.2
8.362-8.366	156.52475-156.52525	2483.5-2500	17.7-21.4
8.37625-8.38675	156.7-156.9	2690-2900	22.01-23.12
8.41425-8.41475	162.0125-167.17	3260-3267	23.6-24.0
12.29-12.293.	167.72-173.2	3332-3339	31.2-31.8
12.51975-12.52025	240-285	3345.8-3358	36.43-36.5
12.57675-12.57725	322-335.4	3600-4400	(\2\)
13.36-13.41			

\1\ Until February 1, 1999, this restricted band shall be 0.490-0.510 MHz.

\2\ Above 38.6

According to §15.247 (d): 20dBc in any 100 kHz bandwidth outside the operating frequency band. In case the emission fall within the restricted band specified on 15.205(a), then the 15.209(a) limit in the table below has to be followed.

Frequencies (MHz)	Field Strength (microvolts/meter)	Measurement Distance (meters)
0.009~0.490	2400/F(KHz)	300
0.490~1.705	24000/F(KHz)	30
1.705~30.0	30	30
30~88	100	3
88~216	150	3
216~960	200	3
Above 960	500	3

6.6.2 Measuring Instruments and Setting:

Please refer to equipment list in this report. The following table is the setting of spectrum analyzer and receiver.

Spectrum Parameter	Setting
Attenuation	Auto
Start Frequency	1000 MHz
Stop Frequency	10 th carrier harmonic
RB / VB (Emission in restricted band)	1MHz / 1MHz for Peak, 1 MHz / 1/B kHz for Average
RB / VB (Emission in non-restricted band)	1MHz / 1MHz for Peak, 1 MHz / 1/B kHz for Average

Receiver Parameter	Setting
Attenuation	Auto
Start ~ Stop Frequency	9kHz~150kHz / RB/VB 200Hz/1KHz for QP/AVG
Start ~ Stop Frequency	150kHz~30MHz / RB/VB 9kHz/30KHz for QP/AVG
Start ~ Stop Frequency	30MHz~1000MHz / RB/VB 120kHz/1MHz for QP

6.6.3 Test Procedures

1) Sequence of testing 9 kHz to 30 MHz

Setup:

- The equipment was set up to simulate a typical usage like described in the user manual or described by manufacturer.
- If the EUT is a tabletop system, a rotatable table with 0.8 m height is used.
- If the EUT is a floor standing device, it is placed on the ground.
- Auxiliary equipment and cables were positioned to simulate normal operation conditions.
- The AC power port of the EUT (if available) is connected to a power outlet below the turntable.
- The measurement distance is 3 meter.
- The EUT was set into operation.

Premeasurement:

- The turntable rotates from 0° to 315° using 45° steps.
- The antenna height is 1.5 meter.
- At each turntable position the analyzer sweeps with peak detection to find the maximum of all emissions

Final measurement:

- Identified emissions during the premeasurement the software maximizes by rotating the turntable position (0° to 360°) and by rotating the elevation axes (0° to 360°).
- The final measurement will be done in the position (turntable and elevation) causing the highest emissions with QPK detector.
- The final levels, frequency, measuring time, bandwidth, turntable position, correction factor, margin to the limit and limit will be recorded. Also a plot with the graph of the premeasurement and the limit will be stored.

2) Sequence of testing 30 MHz to 1 GHz

Setup:

- The equipment was set up to simulate a typical usage like described in the user manual or described by manufacturer.
- If the EUT is a tabletop system, a table with 0.8 m height is used, which is placed on the ground plane.
- If the EUT is a floor standing device, it is placed on the ground plane with insulation between both.
- Auxiliary equipment and cables were positioned to simulate normal operation conditions
- The AC power port of the EUT (if available) is connected to a power outlet below the turntable.
- The measurement distance is 3 meter.
- The EUT was set into operation.

Premeasurement:

- The turntable rotates from 0° to 315° using 45° steps.
- The antenna is polarized vertical and horizontal.
- The antenna height changes from 1 to 3 meter.
- At each turntable position, antenna polarization and height the analyzer sweeps three times in peak to find the maximum of all emissions.

Final measurement:

- The final measurement will be performed with minimum the six highest peaks.
- According to the maximum antenna and turntable positions of premeasurement the software maximize the peaks by changing turntable position ($\pm 45^\circ$) and antenna movement between 1 and 4 meter.
- The final measurement will be done with QP detector with an EMI receiver.
- The final levels, frequency, measuring time, bandwidth, antenna height, antenna polarization, turntable angle, correction factor, margin to the limit and limit will be recorded. Also a plot with the graph of the premeasurement with marked maximum final measurements and the limit will be stored.

3) Sequence of testing 1 GHz to 18 GHz

Setup:

- The equipment was set up to simulate a typical usage like described in the user manual or described by manufacturer.
- If the EUT is a tabletop system, a rotatable table with 1.5 m height is used.
- If the EUT is a floor standing device, it is placed on the ground plane with insulation between both.
- Auxiliary equipment and cables were positioned to simulate normal operation conditions
- The AC power port of the EUT (if available) is connected to a power outlet below the turntable.
- The measurement distance is 3 meter.
- The EUT was set into operation.

Premeasurement:

- The turntable rotates from 0° to 315° using 45° steps.
- The antenna is polarized vertical and horizontal.
- The antenna height scan range is 1 meter to 2.5 meter.
- At each turntable position and antenna polarization the analyzer sweeps with peak detection to find the maximum of all emissions.

Final measurement:

- The final measurement will be performed with minimum the six highest peaks.
- According to the maximum antenna and turntable positions of premeasurement the software maximize the peaks by changing turntable position ($\pm 45^\circ$) and antenna movement between 1 and 4 meter. This procedure is repeated for both antenna polarizations.
- The final measurement will be done in the position (turntable, EUT-table and antenna polarization) causing the highest emissions with Peak and Average detector.
- The final levels, frequency, measuring time, bandwidth, turntable position, EUT-table position, antenna polarization, correction factor, margin to the limit and limit will be recorded. Also a plot with the graph of the premeasurement with marked maximum final measurements and the limit will be stored.

4) Sequence of testing above 18 GHz

Setup:

- The equipment was set up to simulate a typical usage like described in the user manual or described by manufacturer.
- If the EUT is a tabletop system, a rotatable table with 1.5 m height is used.
- If the EUT is a floor standing device, it is placed on the ground plane with insulation between both.
- Auxiliary equipment and cables were positioned to simulate normal operation conditions
- The AC power port of the EUT (if available) is connected to a power outlet below the turntable.
- The measurement distance is 1 meter.
- The EUT was set into operation.

Premeasurement:

- The antenna is moved spherical over the EUT in different polarisations of the antenna.

Final measurement:

- The final measurement will be performed at the position and antenna orientation for all detected emissions that were found during the premeasurements with Peak and Average detector.
- The final levels, frequency, measuring time, bandwidth, correction factor, margin to the limit and limit will be recorded. Also a plot with the graph of the premeasurement and the limit will be stored.

6.6.4 Test Setup Layout

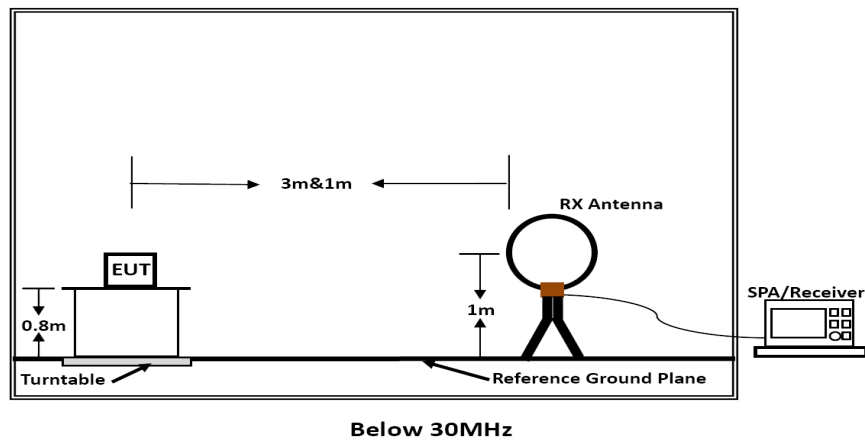

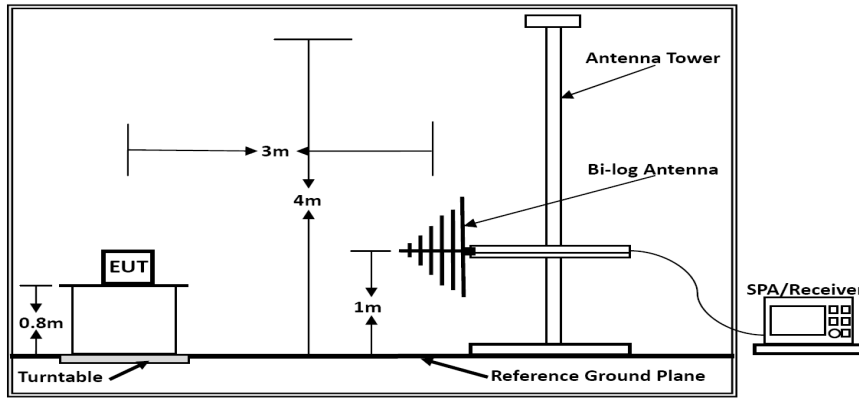

Below 1GHz

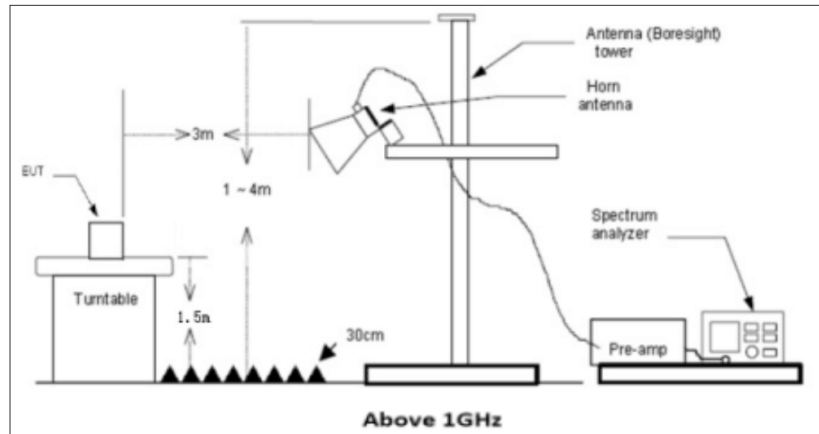

Above 1GHz

Above 18 GHz shall be extrapolated to the specified distance using an extrapolation factor of 20 dB/decade from 3m to 1m.

Distance extrapolation factor = $20 \log(\text{specific distance [3m]} / \text{test distance [1m]})$ (dB);

Limit line = specific limits (dBuV) + distance extrapolation factor [6 dB].

6.6.5 EUT Operation during Test

The EUT was programmed to be in continuously transmitting mode.

6.6.6 Test result

Temperature	25.8°C	Humidity	52.5%
Configurations	IEEE 802.11a/n/ac		

Remarks:

1. Only the worst case Main Antenna test data.
2. Pre-scan all kind of the place mode (X-axis, Y-axis, Z-axis), and found the Y-axis which it is worse case.

■ Results of Radiated Emissions (9 KHz~30MHz)

Freq. (MHz)	Level (dBuV)	Over Limit (dB)	Over Limit (dBuV)	Remark
-	-	-	-	See Note

Note:

The emission from 9 kHz to 30MHz was pre-tested and found the result was 20dB lower than the limit, and the permissible value has no need to be reported.

Distance extrapolation factor = $40 \log(\text{specific distance} / \text{test distance})$ (dB);

Limit line = specific limits (dBuV) + distance extrapolation factor.

■ Results of Radiated Emissions (30MHz~1GHz)

Pre-scan all modes and recorded the worst case results in this report (IEEE 802.11 n(HT20)).

Model name:	DMP-A10	Test Date :	2024-10-09
Polarization :	Vertical	Test Result:	<input checked="" type="checkbox"/> Pass <input type="checkbox"/> Fail

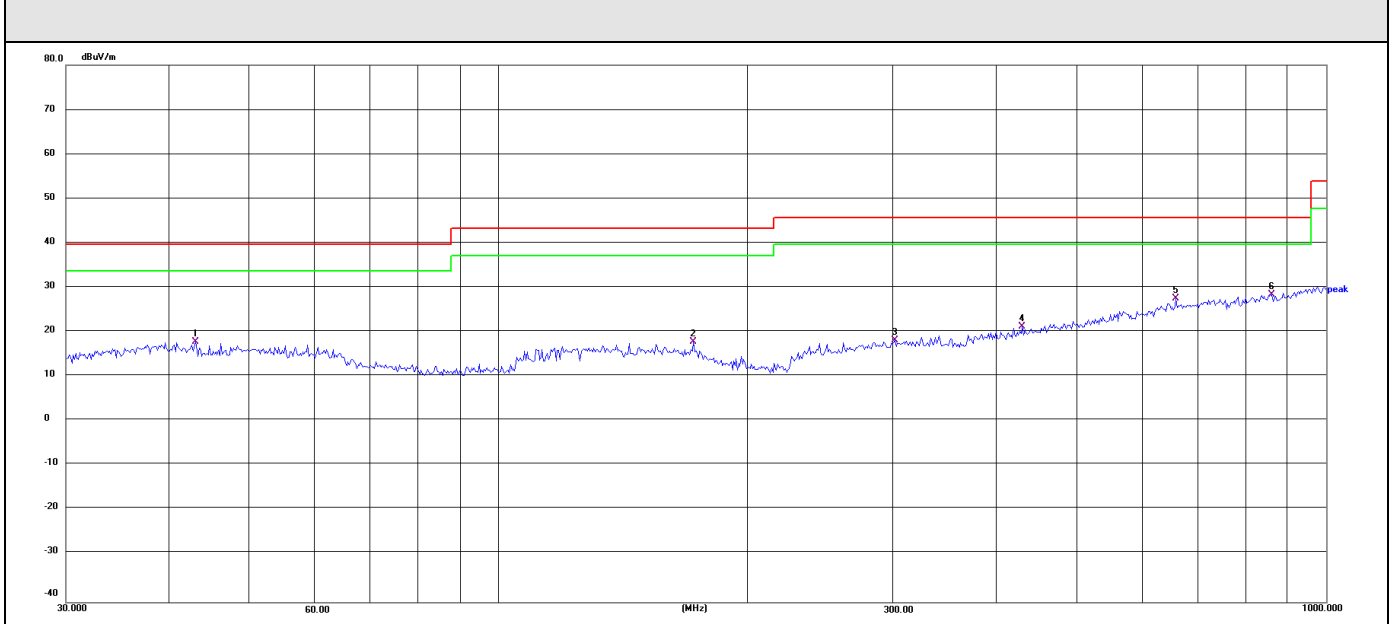

Remark:
 Emission Level = Reading + Factor;
 Factor = Antenna Factor + Cable Loss – Pre-amplifier;
 Margin= Emission Level - Limit.

No.	Frequency (MHz)	Reading (dBuV)	Factor (dB/m)	Level (dBuV/m)	Limit (dBuV/m)	Margin (dB)	Det.
1	43.0504	34.80	-16.61	18.19	40.00	-21.81	QP
2	171.9944	35.35	-17.14	18.21	43.50	-25.29	QP
3	301.4223	35.42	-16.90	18.52	46.00	-27.48	QP
4	429.5228	35.39	-13.77	21.62	46.00	-24.38	QP
5	658.8360	36.72	-8.78	27.94	46.00	-18.06	QP
6 *	860.0351	34.13	-5.30	28.83	46.00	-17.17	QP

Model name:	DMP-A10	Test Date :	2024-10-09
Polarization :	Horizontal	Test Result:	<input checked="" type="checkbox"/> Pass <input type="checkbox"/> Fail

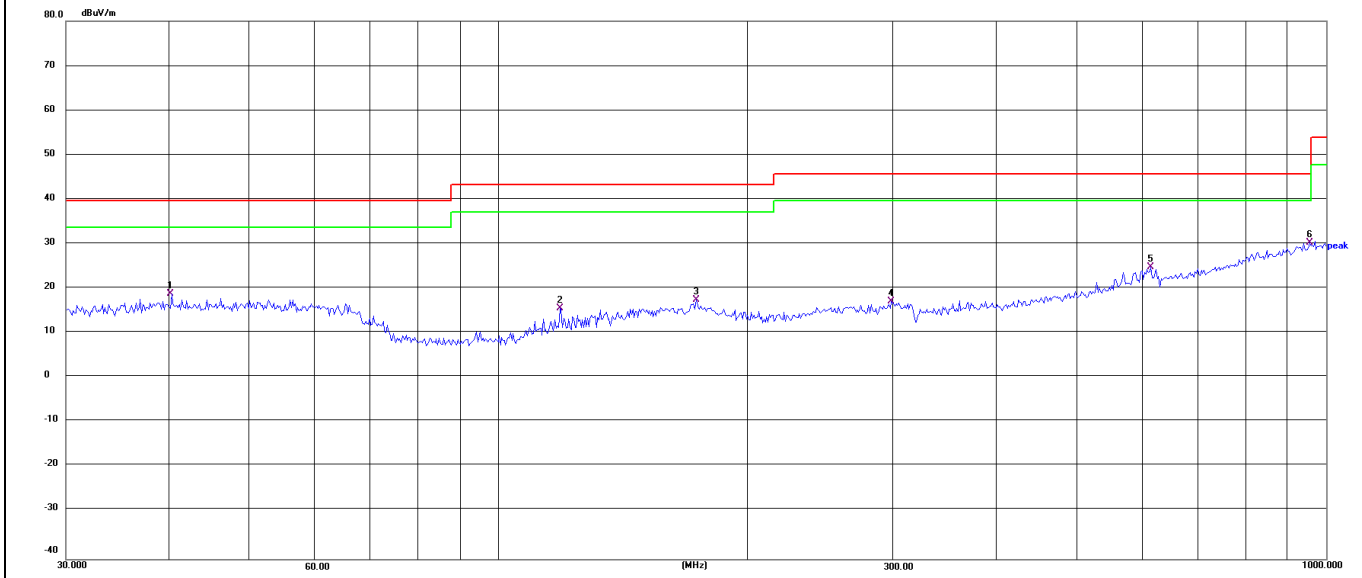

Remark:
 Emission Level = Reading + Factor;
 Factor = Antenna Factor + Cable Loss – Pre-amplifier;
 Margin= Emission Level - Limit.

No.	Frequency (MHz)	Reading (dBuV)	Factor (dB/m)	Level (dBuV/m)	Limit (dBuV/m)	Margin (dB)	Det.
1	40.2754	35.69	-16.46	19.23	40.00	-20.77	QP
2	118.6012	34.55	-18.54	16.01	43.50	-27.49	QP
3	173.2050	35.21	-17.31	17.90	43.50	-25.60	QP
4	298.2681	34.53	-16.99	17.54	46.00	-28.46	QP
5	614.2142	34.66	-9.41	25.25	46.00	-20.75	QP
6 *	955.4380	34.18	-3.49	30.69	46.00	-15.31	QP

Results for Radiated Emissions (1- 40 GHz)

Note: All the modes have been tested and recorded worst mode in the report.(IEEE 802.11n(HT40))

Band I(5.15-5.25) GHz										
Frequency (MHz)	Reading (dBuV)	Amplifier (dB)	Loss (dB)	Antenna Factor (dB/m)	Orrected Factor (dB)	Emission Level (dBµV/m)	Limit (dBuV/m)	Margin (dB)	Detector	Comment
Low Channel (802.11n(HT40)/ 5190 MHz)										
3262.86	44.85	44.70	6.70	28.20	-9.80	35.05	68.20	-33.15	Pk	Vertical
3262.86	41.33	44.70	6.70	28.20	-9.80	31.53	54.00	-22.47	AV	Vertical
3258.43	44.27	44.70	6.70	28.20	-9.80	34.47	68.20	-33.73	Pk	Horizontal
3258.43	40.75	44.70	6.70	28.20	-9.80	30.95	54.00	-23.05	AV	Horizontal
3984.96	39.79	44.20	7.90	29.70	-6.60	33.19	68.20	-35.01	Pk	Vertical
3984.96	37.10	44.20	7.90	29.70	-6.60	30.50	54.00	-23.50	AV	Vertical
3986.57	38.79	44.20	7.90	29.70	-6.60	32.19	68.20	-36.01	Pk	Horizontal
3986.57	36.86	44.20	7.90	29.70	-6.60	30.26	54.00	-23.74	AV	Horizontal
7224.24	36.61	43.50	11.40	35.50	3.40	40.01	68.20	-28.19	Pk	Vertical
7224.24	34.14	43.50	11.40	35.50	3.40	37.54	54.00	-16.46	AV	Vertical
7223.01	37.12	43.50	11.40	35.50	3.40	40.52	68.20	-27.68	Pk	Horizontal
7223.01	33.90	43.50	11.40	35.50	3.40	37.30	54.00	-16.70	AV	Horizontal
10360.27	40.07	44.50	13.80	38.80	8.10	48.17	68.20	-20.03	Pk	Vertical
10360.27	37.00	44.50	13.80	38.80	8.10	45.10	54.00	-8.90	AV	Vertical
10360.39	39.42	44.50	13.80	38.80	8.10	47.52	68.20	-20.68	Pk	Horizontal
10360.39	36.13	44.50	13.80	38.80	8.10	44.23	54.00	-9.77	AV	Horizontal
11026.89	33.48	43.60	14.30	39.50	10.20	43.68	68.20	-24.52	Pk	Vertical
11026.89	29.69	43.60	14.30	39.50	10.20	39.89	54.00	-14.11	AV	Vertical
11030.68	33.34	43.60	14.30	39.50	10.20	43.54	68.20	-24.66	Pk	Horizontal
11030.68	30.70	43.60	14.30	39.50	10.20	40.90	54.00	-13.10	AV	Horizontal
13298.60	32.17	42.60	15.90	38.90	12.20	44.37	68.20	-23.83	Pk	Vertical
13298.60	29.51	42.60	15.90	38.90	12.20	41.71	54.00	-12.29	AV	Vertical
13295.41	31.70	42.60	15.90	38.90	12.20	43.90	68.20	-24.30	Pk	Horizontal
13295.41	29.22	42.60	15.90	38.90	12.20	41.42	54.00	-12.58	AV	Horizontal
Mid Channel (802.11n(HT40)/ 5230 MHz)										
3248.53	44.63	44.70	6.70	28.20	-9.80	34.83	68.20	-33.37	Pk	Vertical
3248.53	41.71	44.70	6.70	28.20	-9.80	31.91	54.00	-22.09	AV	Vertical
3249.79	45.13	44.70	6.70	28.20	-9.80	35.33	68.20	-32.87	Pk	Horizontal
3249.79	41.50	44.70	6.70	28.20	-9.80	31.70	54.00	-22.30	AV	Horizontal
3997.30	38.78	44.20	7.90	29.70	-6.60	32.18	68.20	-36.02	Pk	Vertical
3997.30	36.70	44.20	7.90	29.70	-6.60	30.10	54.00	-23.90	AV	Vertical
3997.31	38.76	44.20	7.90	29.70	-6.60	32.16	68.20	-36.04	Pk	Horizontal
3997.31	36.79	44.20	7.90	29.70	-6.60	30.19	54.00	-23.81	AV	Horizontal
7216.52	36.45	43.50	11.40	35.50	3.40	39.85	68.20	-28.35	Pk	Vertical
7216.52	34.73	43.50	11.40	35.50	3.40	38.13	54.00	-15.87	AV	Vertical



7233.17	36.63	43.50	11.40	35.50	3.40	40.03	68.20	-28.17	Pk	Horizontal
7233.17	34.35	43.50	11.40	35.50	3.40	37.75	54.00	-16.25	AV	Horizontal
10400.23	39.13	44.50	13.80	38.80	8.10	47.23	68.20	-20.97	Pk	Vertical
10400.23	36.90	44.50	13.80	38.80	8.10	45.00	54.00	-9.00	AV	Vertical
10400.03	39.60	44.50	13.80	38.80	8.10	47.70	68.20	-20.50	Pk	Horizontal
10400.03	36.70	44.50	13.80	38.80	8.10	44.80	54.00	-9.20	AV	Horizontal
11022.67	33.43	43.60	14.30	39.50	10.20	43.63	68.20	-24.57	Pk	Vertical
11022.67	30.33	43.60	14.30	39.50	10.20	40.53	54.00	-13.47	AV	Vertical
11031.42	33.63	43.60	14.30	39.50	10.20	43.83	68.20	-24.37	Pk	Horizontal
11031.42	29.81	43.60	14.30	39.50	10.20	40.01	54.00	-13.99	AV	Horizontal
13297.67	32.46	42.60	15.90	38.90	12.20	44.66	68.20	-23.54	Pk	Vertical
13297.67	29.99	42.60	15.90	38.90	12.20	42.19	54.00	-11.81	AV	Vertical
13288.41	32.24	42.60	15.90	38.90	12.20	44.44	68.20	-23.76	Pk	Horizontal
13288.41	28.90	42.60	15.90	38.90	12.20	41.10	54.00	-12.90	AV	Horizontal

Notes:

- 1). Measuring frequencies from 9 KHz ~ 40GHz, No emission found between lowest internal used/generated frequency to 30MHz.
- 2). Radiated emissions measured in frequency range from 9 KHz ~ 40GHz were made with an instrument using Peak detector mode.
- 3). 18~40GHz at least have 20dB margin. No recording in the test report.
- 4). 3. Worst case data at 6Mbps at IEEE 802.11a; MCS0 at IEEE 802.11n HT20, IEEE 802.11n HT40, IEEE 802.11ac VHT20, IEEE 802.11ac VHT40, IEEE 802.11ac VHT80; IEEE 802.11ax HE20, IEEE 802.11ax HE40, IEEE 802.11ax HE80;
- 5). Data of measurement within this frequency range shown "---" in the table above means the reading of emissions are attenuated more than 20dB below the permissible limits or the field strength is too small to be measured.
- 6). Margin= Emission Level – Limit

Radiation Restricted band

Band I(5.15-5.35) GHz										
Frequency	Meter Reading	Amplifier	Loss	Antenna Factor	Orrected Factor	Emission Level	Limits	Margin	Detector	Comment
(MHz)	(dBµV)	(dB)	(dB)	(dB/m)	(dB)	(dBµV/m)	(dBµV/m)	(dB)	Type	
802.11a BW20MHz										
5150	40.18	44.20	8.98	31.60	-3.62	36.56	68.20	-31.64	Peak	Vertical
5150	28.62	44.20	8.98	31.60	-3.62	25.00	54.00	-29.00	AVG	Vertical
5150	40.47	44.20	8.98	31.60	-3.62	36.85	68.20	-31.35	Peak	Horizontal
5150	29.95	44.20	8.98	31.60	-3.62	26.33	54.00	-27.67	AVG	Horizontal
5350	44.24	44.20	9.35	31.60	-3.25	40.99	68.20	-27.21	Peak	Vertical
5350	31.81	44.20	9.35	31.60	-3.25	28.56	54.00	-25.44	AVG	Vertical
5350	38.96	44.20	9.35	31.60	-3.25	35.71	68.20	-32.49	Peak	Horizontal
5350	29.10	44.20	9.35	31.60	-3.25	25.85	54.00	-28.15	AVG	Horizontal
802.11n BW20MHz										
5150	40.20	44.20	8.98	31.60	-3.62	36.58	68.20	-31.62	Peak	Vertical
5150	28.98	44.20	8.98	31.60	-3.62	25.36	54.00	-28.64	AVG	Vertical
5150	38.63	44.20	8.98	31.60	-3.62	35.01	68.20	-33.19	Peak	Horizontal
5150	28.16	44.20	8.98	31.60	-3.62	24.54	54.00	-29.46	AVG	Horizontal
5350	44.54	44.20	9.35	31.60	-3.25	41.29	68.20	-26.91	Peak	Vertical
5350	30.96	44.20	9.35	31.60	-3.25	27.71	54.00	-26.29	AVG	Vertical
5350	38.97	44.20	9.35	31.60	-3.25	35.72	68.20	-32.48	Peak	Horizontal
5350	31.57	44.20	9.35	31.60	-3.25	28.32	54.00	-25.68	AVG	Horizontal
802.11n BW40MHz										
5150	41.98	44.20	8.98	31.60	-3.62	38.36	68.20	-29.84	Peak	Vertical
5150	28.35	44.20	8.98	31.60	-3.62	24.73	54.00	-29.27	AVG	Vertical
5150	38.69	44.20	8.98	31.60	-3.62	35.07	68.20	-33.13	Peak	Horizontal
5150	29.33	44.20	8.98	31.60	-3.62	25.71	54.00	-28.29	AVG	Horizontal
5350	44.71	44.20	9.35	31.60	-3.25	41.46	68.20	-26.74	Peak	Vertical
5350	27.74	44.20	9.35	31.60	-3.25	24.49	54.00	-29.51	AVG	Vertical
5350	42.04	44.20	9.35	31.60	-3.25	38.79	68.20	-29.41	Peak	Horizontal
5350	30.30	44.20	9.35	31.60	-3.25	27.05	54.00	-26.95	AVG	Horizontal
802.11ac BW20MHz										
5150	41.59	44.20	8.98	31.60	-3.62	37.97	68.20	-30.23	Peak	Vertical
5150	31.72	44.20	8.98	31.60	-3.62	28.10	54.00	-25.90	AVG	Vertical
5150	38.78	44.20	8.98	31.60	-3.62	35.16	68.20	-33.04	Peak	Horizontal
5150	27.96	44.20	8.98	31.60	-3.62	24.34	54.00	-29.66	AVG	Horizontal
5350	46.69	44.20	9.35	31.60	-3.25	43.44	68.20	-24.76	Peak	Vertical
5350	30.33	44.20	9.35	31.60	-3.25	27.08	54.00	-26.92	AVG	Vertical
5350	41.99	44.20	9.35	31.60	-3.25	38.74	68.20	-29.46	Peak	Horizontal
5350	30.23	44.20	9.35	31.60	-3.25	26.98	54.00	-27.02	AVG	Horizontal

802.11ac BW40MHz										
5150	38.95	44.20	8.98	31.60	-3.62	35.33	68.20	-32.87	Peak	Vertical
5150	28.41	44.20	8.98	31.60	-3.62	24.79	54.00	-29.21	AVG	Vertical
5150	41.22	44.20	8.98	31.60	-3.62	37.60	68.20	-30.60	Peak	Horizontal
5150	30.78	44.20	8.98	31.60	-3.62	27.16	54.00	-26.84	AVG	Horizontal
5350	42.55	44.20	9.35	31.60	-3.25	39.30	68.20	-28.90	Peak	Vertical
5350	27.60	44.20	9.35	31.60	-3.25	24.35	54.00	-29.65	AVG	Vertical
5350	40.45	44.20	9.35	31.60	-3.25	37.20	68.20	-31.00	Peak	Horizontal
5350	29.51	44.20	9.35	31.60	-3.25	26.26	54.00	-27.74	AVG	Horizontal
802.11ac BW80MHz										
5150	40.50	44.20	8.98	31.60	-3.62	36.88	68.20	-31.32	Peak	Vertical
5150	31.38	44.20	8.98	31.60	-3.62	27.76	54.00	-26.24	AVG	Vertical
5150	41.80	44.20	8.98	31.60	-3.62	38.18	68.20	-30.02	Peak	Horizontal
5150	29.56	44.20	8.98	31.60	-3.62	25.94	54.00	-28.06	AVG	Horizontal
5350	45.85	44.20	9.35	31.60	-3.25	42.60	68.20	-25.60	Peak	Vertical
5350	29.92	44.20	9.35	31.60	-3.25	26.67	54.00	-27.33	AVG	Vertical
5350	41.83	44.20	9.35	31.60	-3.25	38.58	68.20	-29.62	Peak	Horizontal
5350	29.84	44.20	9.35	31.60	-3.25	26.59	54.00	-27.41	AVG	Horizontal
802.11ax BW20MHz										
5150	39.17	44.20	8.98	31.60	-3.62	35.55	68.20	-32.65	Peak	Vertical
5150	31.83	44.20	8.98	31.60	-3.62	28.21	54.00	-25.79	AVG	Vertical
5150	38.69	44.20	8.98	31.60	-3.62	35.07	68.20	-33.13	Peak	Horizontal
5150	31.29	44.20	8.98	31.60	-3.62	27.67	54.00	-26.33	AVG	Horizontal
5350	45.87	44.20	9.35	31.60	-3.25	42.62	68.20	-25.58	Peak	Vertical
5350	28.98	44.20	9.35	31.60	-3.25	25.73	54.00	-28.27	AVG	Vertical
5350	38.79	44.20	9.35	31.60	-3.25	35.54	68.20	-32.66	Peak	Horizontal
5350	28.49	44.20	9.35	31.60	-3.25	25.24	54.00	-28.76	AVG	Horizontal
802.11ax BW40MHz										
5150	41.88	44.20	8.98	31.60	-3.62	38.26	68.20	-29.94	Peak	Vertical
5150	30.82	44.20	8.98	31.60	-3.62	27.20	54.00	-26.80	AVG	Vertical
5150	38.24	44.20	8.98	31.60	-3.62	34.62	68.20	-33.58	Peak	Horizontal
5150	28.74	44.20	8.98	31.60	-3.62	25.12	54.00	-28.88	AVG	Horizontal
5350	43.01	44.20	9.35	31.60	-3.25	39.76	68.20	-28.44	Peak	Vertical
5350	32.06	44.20	9.35	31.60	-3.25	28.81	54.00	-25.19	AVG	Vertical
5350	39.90	44.20	9.35	31.60	-3.25	36.65	68.20	-31.55	Peak	Horizontal
5350	28.08	44.20	9.35	31.60	-3.25	24.83	54.00	-29.17	AVG	Horizontal
802.11ax BW80MHz										
5150	39.65	44.20	8.98	31.60	-3.62	36.03	68.20	-32.17	Peak	Vertical
5150	29.12	44.20	8.98	31.60	-3.62	25.50	54.00	-28.50	AVG	Vertical
5150	42.11	44.20	8.98	31.60	-3.62	38.49	68.20	-29.71	Peak	Horizontal
5150	30.49	44.20	8.98	31.60	-3.62	26.87	54.00	-27.13	AVG	Horizontal
5350	42.94	44.20	9.35	31.60	-3.25	39.69	68.20	-28.51	Peak	Vertical
5350	31.01	44.20	9.35	31.60	-3.25	27.76	54.00	-26.24	AVG	Vertical
5350	41.14	44.20	9.35	31.60	-3.25	37.89	68.20	-30.31	Peak	Horizontal



5350	29.31	44.20	9.35	31.60	-3.25	26.06	54.00	-27.94	AVG	Horizontal
------	-------	-------	------	-------	-------	-------	-------	--------	-----	------------

Remarks:

- 1). *Margin = Emission Level – Limit*
- 2). *Emission Level = Reading + Factor*
- 3). *Factor = Antenna Factor + Cable Loss – Pre-amplifie*

6.7 Power Line Conducted Emissions

6.7.1 Standard requirement:

According to §15.207 (a): For an intentional radiator which is designed to be connected to the public utility (AC) power line, the radio frequency voltage that is conducted back onto the AC power line on any frequency or frequencies within the band 150 kHz to 30 MHz shall not exceed 250 microvolts (The limit decreases linearly with the logarithm of the frequency in the range 0.15 MHz to 0.50 MHz). The limits at specific frequency range is listed as follows:

Frequency Range (MHz)	Limits (dB μ V)	
	Quasi-peak	Average
0.15 to 0.50	66 to 56	56 to 46
0.50 to 5	56	46
5 to 30	60	50

* Decreasing linearly with the logarithm of the frequency

6.7.2 Test Setup Layout

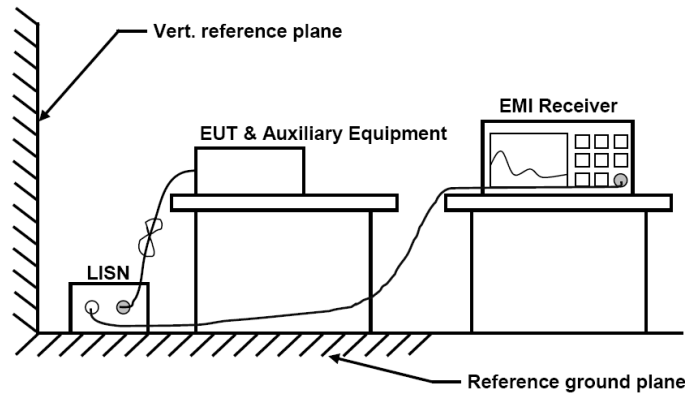

6.7.3 Test Procedures

The transmitter output is connected to EMI receiver. The resolution bandwidth is set to 9 kHz. The video bandwidth is set to 30 kHz, Sweep time=Auto
 The spectrum from 150 kHz to 30MHz is investigated with the transmitter set to the lowest, middle, and highest channels.

6.7.4 EUT Operation during Test

The EUT was programmed to be in continuously transmitting mode.

6.7.5 Test result

PASS

The test data please refer to following page.

Measurement data:

AC Conducted Emission of charge from Adapter mode @ AC 120V/60Hz @ (IEEE 802.11n(HT20)) (worst case)

Model name:	DMP-A10	Test Date :	2024-10-09
Temperature:	25.8° C	Relative Humidity:	52.5%
ATM Pressure:	101 kPa	Test Result:	<input checked="" type="checkbox"/> Pass <input type="checkbox"/> Fail
Phase :	Line		

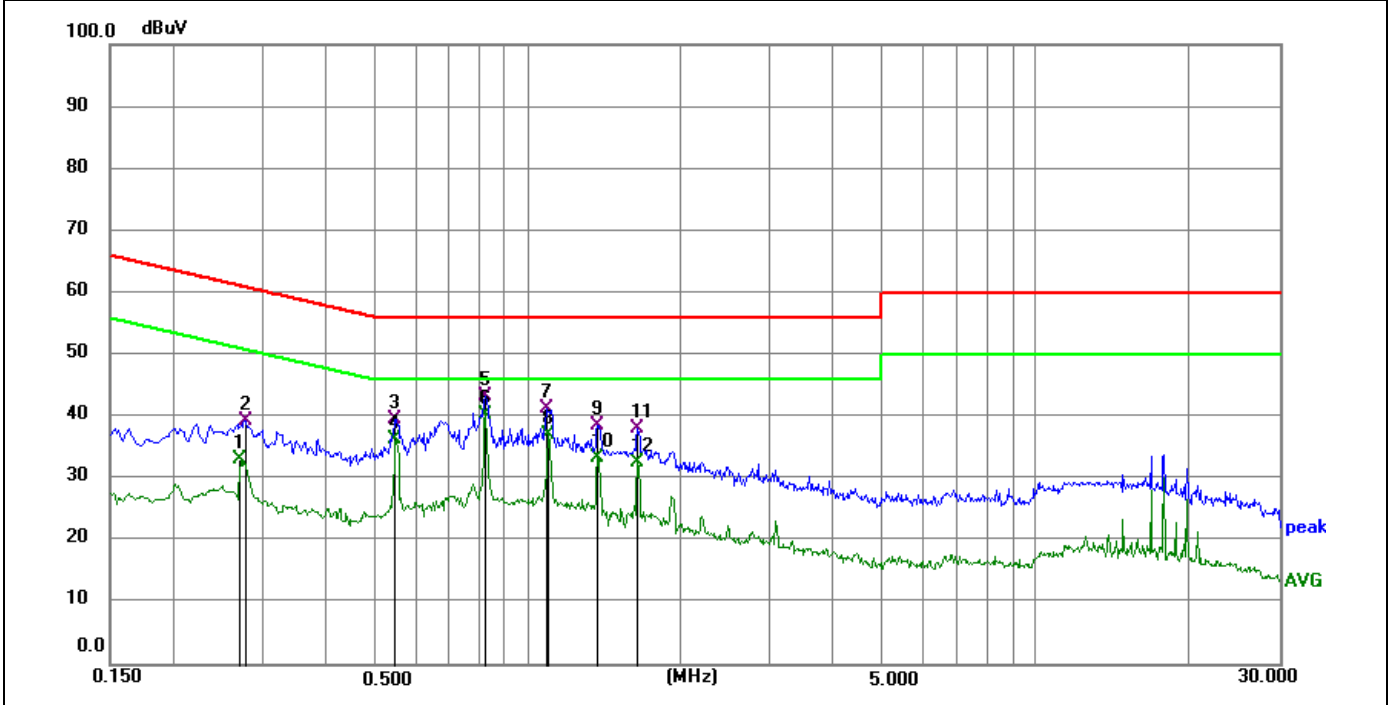

Remark: Correct Factor = Insertion loss of LISN + Cable loss + Insertion loss of Pulse Limiter;
 Measurement Result = Reading Level +Correct Factor;
 Margin = Measurement Result- Limit;

No.	Frequency (MHz)	Reading (dBuV)	Correct (dB)	Result (dBuV)	Limit (dBuV)	Margin (dB)	Remark
1	0.2714	22.36	10.70	33.06	51.07	-18.01	AVG
2	0.2760	28.72	10.70	39.42	60.94	-21.52	QP
3	0.5460	28.96	10.68	39.64	56.00	-16.36	QP
4	0.5503	25.71	10.68	36.39	46.00	-9.61	AVG
5	0.8250	32.55	10.66	43.21	56.00	-12.79	QP
6	0.8250	29.61	10.66	40.27	46.00	-5.73	AVG
7	1.0905	30.64	10.66	41.30	56.00	-14.70	QP
8	1.0950	26.37	10.66	37.03	46.00	-8.97	AVG
9	1.3690	27.91	10.69	38.60	56.00	-17.40	QP
10	1.3690	22.68	10.69	33.37	46.00	-12.63	AVG
11	1.6440	27.25	10.74	37.99	56.00	-18.01	QP
12	1.6440	21.93	10.74	32.67	46.00	-13.33	AVG

Model name:	DMP-A10	Test Date :	2024-10-09
Temperature:	25.5° C	Relative Humidity:	52.4%
ATM Pressure:	101 kPa	Test Result:	<input checked="" type="checkbox"/> Pass <input type="checkbox"/> Fail
Phase :	Neutral		

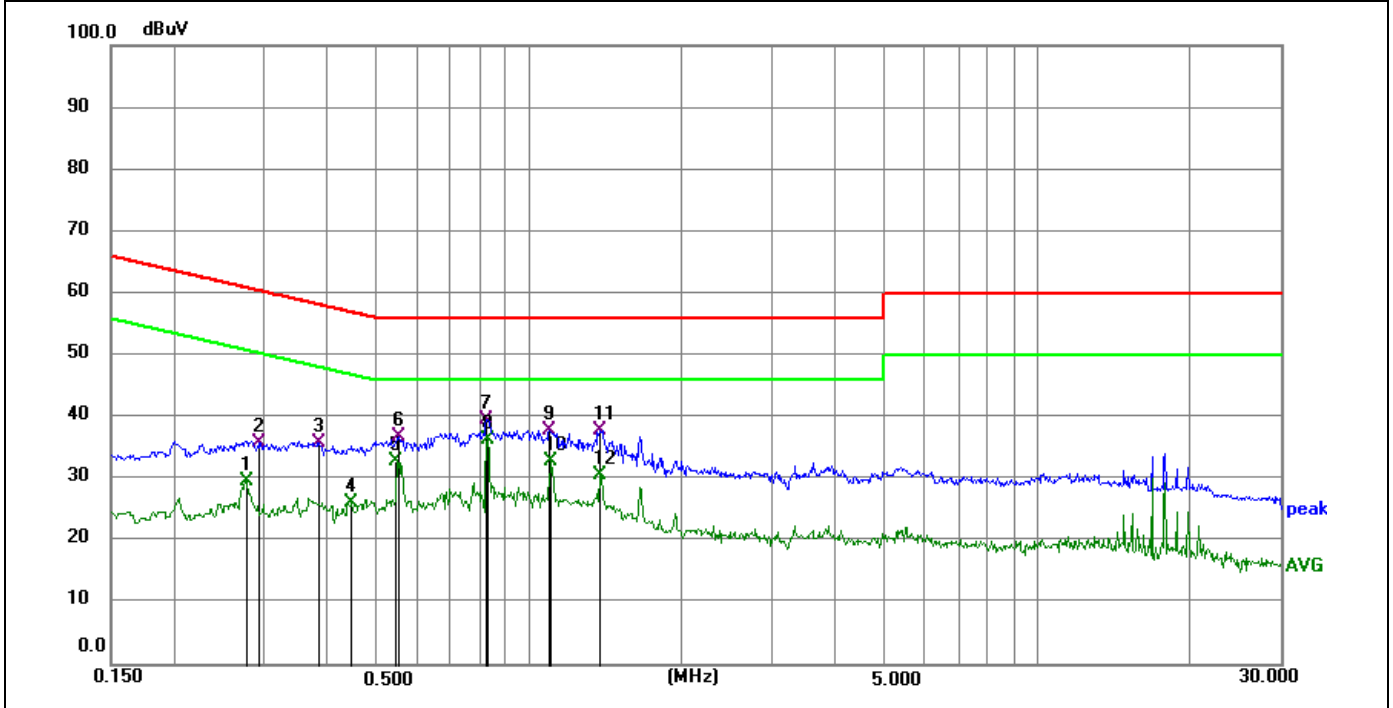

Remark: Correct Factor = Insertion loss of LISN + Cable loss + Insertion loss of Pulse Limiter;
 Measurement Result = Reading Level +Correct Factor;
 Margin = Measurement Result- Limit;

No.	Frequency (MHz)	Reading (dBuV)	Correct (dB)	Result (dBuV)	Limit (dBuV)	Margin (dB)	Remark
1	0.2760	19.03	10.69	29.72	50.94	-21.22	AVG
2	0.2940	25.29	10.69	35.98	60.41	-24.43	QP
3	0.3840	25.29	10.69	35.98	58.19	-22.21	QP
4	0.4470	15.61	10.69	26.30	46.93	-20.63	AVG
5	0.5503	22.21	10.68	32.89	46.00	-13.11	AVG
6	0.5522	26.27	10.68	36.95	56.00	-19.05	QP
7	0.8250	29.05	10.65	39.70	56.00	-16.30	QP
8	0.8295	25.79	10.65	36.44	46.00	-9.56	AVG
9	1.0990	27.30	10.65	37.95	56.00	-18.05	QP
10	1.1040	22.27	10.65	32.92	46.00	-13.08	AVG
11	1.3785	27.22	10.69	37.91	56.00	-18.09	QP
12	1.3785	20.05	10.69	30.74	46.00	-15.26	AVG

Notes:

1. An initial pre-scan was performed on the line and neutral lines with peak detector.
2. Quasi-Peak and Average measurement were performed at the frequencies with maximized peak emission.
3. If the average limit is met when using a quasi-peak detector receiver, the EUT shall be deemed to meet both limits and measurement with the average detector receiver is unnecessary.

6.8 Frequency Stability

6.8.1 Standard requirement:

According to FCC §15.407(g) “Manufacturers of U-NII devices are responsible for ensuring frequency stability such that an emission is maintained within the band of operation under all conditions of normal operation as specified in the users manual.”

According to FCC §2.1055(a) “The frequency stability shall be measured with variation of ambient temperature as follows:”

- (1) From -30° to $+50^{\circ}$ centigrade for all equipment except that specified in paragraphs (a) (2) and (3) of this section.
- (2) From -20° to $+50^{\circ}$ centigrade for equipment to be licensed for use in the Maritime Services under part 80 of this chapter, except for Class A, B, and S Emergency Position Indicating Radiobeacons (EPIRBS), and equipment to be licensed for use above 952 MHz at operational fixed stations in all services, stations in the Local Television Transmission Service and Point-to-Point Microwave Radio Service under part 21 of this chapter, equipment licensed for use aboard aircraft in the Aviation Services under part 87 of this chapter, and equipment authorized for use in the Family Radio Service under part 95 of this chapter.

From 0° to $+50^{\circ}$ centigrade for equipment to be licensed for use in the Radio Broadcast Services under part 73 of this chapter.

6.8.2 Measuring Instruments and Setting:

Please refer to equipment list in this report.

6.8.3 Test Procedures

The equipment under test was connected to an external AC or DC power supply and input rated voltage. RF output was connected to a frequency counter or spectrum analyzer via feed through attenuators. The EUT was placed inside the temperature chamber. Set the spectrum analyzer RBW low enough to obtain the desired frequency resolution and measure EUT 20 degree operating frequency as reference frequency. Turn EUT off and set the chamber temperature to -30 degree. After the temperature stabilized for approximately 30 minutes recorded the frequency. Repeat step measure with 10 degree increased per stage until the highest temperature of +50 degree reached.

6.8.4 Test Setup Layout

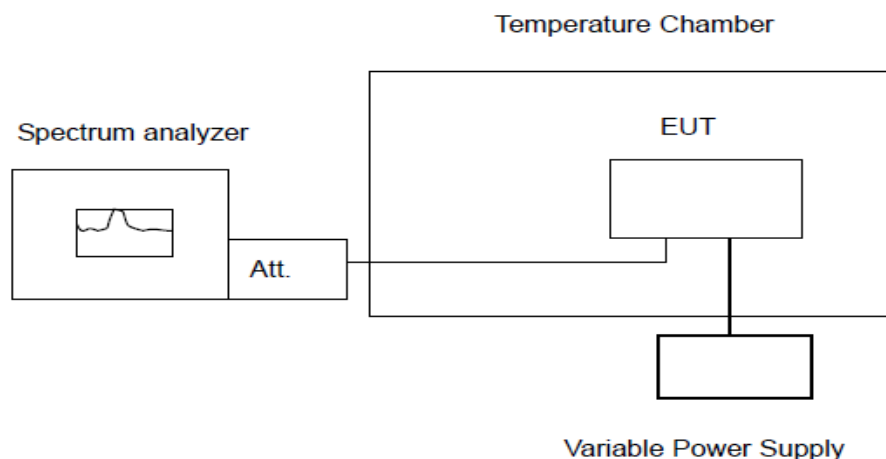

6.8.5 EUT Operation during Test

The EUT was programmed to be in continuously transmitting mode.

6.8.6 Test result

PASS

Please refer to Appendix D

Remark:

1. *Measured all conditions and recorded worst case.*

7 Test Setup Photographs of EUT

Please refer to separated files for Test Setup Photos of the EUT.

8 External Photographs of EUT

Please refer to separated files for External Photos of the EUT.

9 Internal Photographs of EUT

Please refer to separated files for Internal Photos of the EUT.

-----End-----