



2.4 GHz



WIRELESS TIG FOOT PEDAL

Operator's Manual

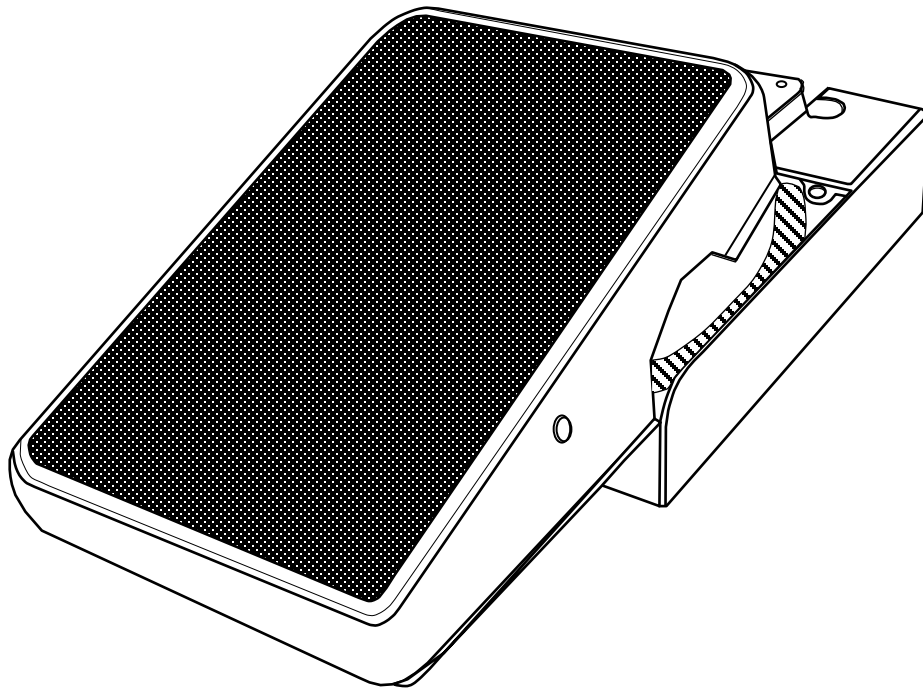

MODEL: NVA-FT06
SERIAL NUMBER:
APPLICATION:
FCC PEDAL/TRANSMITTER ID:
FCC RECEIVER ID:
OTHER:

NOVA WELDING INDUSTRIES

380 Swift Ave. Unit 12 South San Francisco, CA 94080, USA

TABLE OF CONTENTS

SPECIAL NOTICE AND CALIFORNIA PROPOSITION 65 WARNING, FCC Usage Information	3
SAFETY DISCLAIMER AND HF WARNING	4
SPECIFICATIONS, COMPATIBILITY NUMBERS	8
COMPONENT ID	9
INTRODUCTORY NOTICE ON SHIPPING AND PEDAL TOP SERVICING	10
UNPACKING YOUR UNIT	11
PAIRING INFORMATION	11
CONNECTING THE BATTERY WIRES BEFORE USE	12
CHARGING THE BATTERY	12
CONNECTING THE RECEIVER DONGLE TO WELDER	12
OPERATION OF THE NOVA WIRELESS PEDAL	13
TROUBLESHOOTING	15

RECYCLE. DO NOT DISCARD THIS PRODUCT IN THE TRASH!

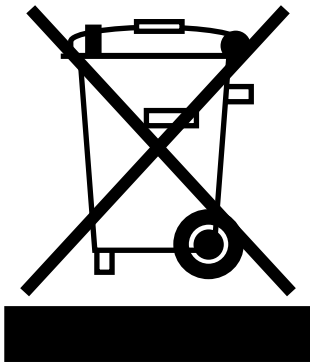

This Wireless Pedal has been designed for a long life. However, in the event part(s) or all of this product becomes non serviceable:

- Do not discard this product or its parts in general waste. Do not burn or attempt to destroy this product or damage it further.
- Reuse or Recycle Waste Electrical And Electronic Equipment (WEEE) by disposing of it at a designated recycling or collection facility.
- Contact your local government or disposal/collection facility for recycling information and locations. Or contact NOVA for further recycling or repair information.

NOTICE:

Product Specifications and features are subject to change without notice. While every attempt has been made to provide the most accurate and current information possible at the time of publication, this manual is intended to be a general guide and not intended to be exhaustive in its content regarding safety, welding, or the operation/maintenance of this unit. Due to multiple variables that exist in the welding field and the changing nature of it and of the NOVA Welding Industries does not guarantee the accuracy, completeness, authority or authenticity of the information contained within this manual or of any information offered during the course of conversation or business by any NOVA employee or subsidiary. The owner of this product assumes all liability for its use and maintenance. NOVA does not warrant this product or this document for fitness for any particular purpose, for performance/accuracy or for suitability of application. Furthermore NOVA does not accept liability for injury or damages, consequential or incidental, resulting from the use of this product or resulting from the content found in this document or accept claims by a third party of such liability.

WARNING!

California Proposition 65 Warning:

This product, when used for welding or cutting, produces fumes or gases which contain chemicals known to the State of California to cause birth defects and, in some cases, cancer. (California Health & Safety Code § 25249.5 et seq.)

 Warning: Cancer and/or Reproductive Harm

www.P65warnings.ca.gov

FCC Information



This equipment has been tested and found to comply with the limits for a Class B digital device, pursuant to part 15 of the FCC Rules. These limits are designed to provide reasonable protection against harmful interference in a residential installation. This equipment generates, uses and can radiate radio frequency energy, and if not installed and used in accordance with instructions, may cause harmful interference to radio communications. However, there is no guarantee that interference will not occur in a particular installation. If this equipment does cause harmful interference to radio or television reception, which can be determined by turning the equipment off and on, the user is encouraged to try to correct the interference by one or more of the following measures:

- Relocate or reorient the transmitter (pedal) and/or receiving antenna (dongle).
- Increase the separation distance between the equipment and receiver.
- Connect the equipment into an outlet on a circuit different from that to which the receiver is connected.
- Consult NOVA, the installing electrician or an experienced radio/TV technician for help.

This device complies with part 15 of the FCC Rules. Operation is subject to the following two conditions: (1) This device may not cause harmful interference, and (2) this device must accept any interference received, including interference that may cause undesired operation.

Caution: Any changes or modifications to this device not explicitly approved by manufacturer could void your authority to operate this equipment.

RF Exposure Information

The device has been evaluated to meet general RF exposure requirement. The device can be used in portable exposure condition without restriction.

If interference cannot be eliminated, discontinue use and contact NOVA.



Safe operation and proper maintenance is your responsibility.

NOVA Welding Industries is dedicated to keeping safety a top priority. While we have compiled this operator's manual to instruct you in basic safe operation and maintenance of your NOVA product, it is no substitute for observing safe welding practices and behavior. Safe welding and related operations require basic knowledge, experience and ultimately the exercise of common sense. **Welding does significant hazards to your health and life! Exercise extreme caution and care in all activities related to welding or cutting. Your safety, health and even life depends upon it.**

WARNING! If you do not have proper knowledge or capability to safely install and operate this foot pedal, do not use this pedal until proper training has been received.

While accidents are never planned, preventing an accident requires careful planning. Stay alert! Keep wires and chargers properly stored. Keep pedal switched to "OFF" when not in use.

Please carefully read this manual before you install and operate your NOVA TIG foot pedal.

The warranty does not cover damage or harm created by improper use, neglect of the pedal or failure to follow safe operating practices.

NOTICE:



- Welding and cutting operations may generate undesirable High Frequency (HF) and EMF energy. This can interfere with surrounding electronic equipment such as computers, routers, CNC equipment, televisions, communication equipment, radios, fluorescent lighting, navigation equipment, etc.
- This unit uses low level radio frequencies
- Only use licensed electricians or qualified electronics installers familiar with similar electronic equipment to install this equipment for use.
- The user is responsible to have any suspected interference resulting from the installation and use of this product investigated and corrected by a qualified individual in a prompt manner.
- If notified by the FCC that the unit is causing interference, you must stop using this equipment at once.
- Do not attempt to modify this equipment or change the way this unit operates in any way.
- Keep the unit in good repair, including batteries, antennas and cables.

Safety Warnings, Dangers, Cautions and Instructions



NOTICE. This unit manual is intended for users with basic knowledge and skillset in welding. It is your responsibility to make certain that the use of this welder is restricted to persons who have read, understand and follow the warnings and instructions in this manual. If you or the operator needs further instruction, contact NOVA at 1-877 755-9353.



WARNING! High Frequency (HF) energy can interfere with the operation of pacemakers and can damage pacemakers. Consult with your physician and pacemaker manufacturer *before* entering an area where welding and cutting equipment is in operation and *before* using this welder. Some pacemakers have limited shielding. Alert any users or customers of this po-



WARNING! Use approved safety glasses with wrap around shields and sides while welding and working in the weld area or serious eye damage or loss of vision may result. Use a grinding shield in addition to the safety glasses during chipping and grinding operations.



WARNING! When welding always use an approved welding helmet or shielding device equipped with at least an equivalent of a shade 9 or greater. Increase the shade number rating as amperage increase over 100 amps. Inspect helmet for cracks in lenses and in the helmet. Keep lens covers in good condition and replace as necessary.



WARNING! Welding/cutting operations carry inherent risks which include but not limited to possible cuts burns, electrical shocks, lung damage, eye damage and even death. Take all appropriate measures to use proper Personal Protective Equipment (PPE). Always use leather welding gloves, closed toe (preferably reinforced or steel toe leather shoes, and long-sleeved flame resistant clothing (i.e. denim). Do not wear Poly/Nylon blend materials.



DANGER! Welding/cutting poses shock and electrocution risks. Keep this welding equipment dry. **Do not weld in the rain or where moisture accumulates.** Use dry, rubber soled shoes, gloves and clothing when welding. Do not rest or contact work clamp (ground) when welding. Keep all parts of the body insulated from the part being welded when possible. Do not touch terminals or connections while the unit is on. Consider all parts to be “live” at all times even if no live work is being performed. Do not use frayed welding cables.





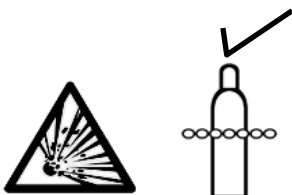

CAUTION! Fires are possible but also preventable while welding. Always remove flammable rags, papers, and other materials from the weld area. Keep rags stored in an approved flame proof canister. Keep a fully charged fire extinguisher at hand. Remove any fuels, oils, paint, pressurized spray cans, and chemicals from the weld area. Make sure any smoke/fire detectors are function properly. Do not weld on tanks, drums or barrels, especially if pressurized or sealed. Do not weld on any container that previously held fuel or chemicals. Make sure the weld area is clear of flammable materials such as grass or wood shavings solvents and fuels. Do not wear frayed or loose clothing. Visually inspect and recheck the work area after welding looking for smoldering debris or flames.









WARNING! Welding gas cylinders are under high pressure. Keep all gas cylinders upright and chained to a cart or held safely in a safety holding pen. Never transport gas cylinders in an enclosed car van or other vehicle. Transport gas cylinders securely. Keep all cylinders capped while not in use or during transport. Replace the cap on the cylinder when it is going to be more than 24 hours before use. Do not use or attempt to repair faulty regulators. Never weld on gas cylinders. Keep gas cylinders away from direct sparks.

Safety Warnings, Dangers, Cautions and Instructions

	<p>DANGER! Welding and cutting operations pose serious inhalation hazards. Some of these hazards are immediate while others are cumulative in their effect. Do not weld in enclosed spaces or in areas without adequate ventilation. Fumes and gases released in the welding and cutting operations can be toxic. Use fans or respiration equipment to insure adequate ventilation if you are welding in a shop or garage area. Do not weld on galvanized metal under any circumstance. You may develop metal fume fever. Symptoms are similar to lu-like symptoms. Seek medical advice and treatment if you are exposed to galvanized welding fumes.</p> <p>If you experience any eye burning, nose or throat irritation while welding, these are signs that you need more ventilation.</p> <p>If you feel these symptoms:</p> <ul style="list-style-type: none"> • Stop work immediately and relocate work area with better ventilation. • Wash and clean your face and hands. • Stop work completely and seek medical help if irritation persists
	<p>DANGER! Never use brake cleaner or any chlorinated solvent to clean or degrease metal scheduled to be welded or other related equipment in the area being welded. The heating of this cleaner and its residue will create highly toxic phosgene gas. Small amounts of this vapor are harmful and can lead to organ failure and death. If degreasing of a part is necessary, use Acetone or an approved pre-weld cleaner. Use the proper personal protective equipment (PPE) when handling any cleaners/solvents.</p>
	<p>DANGER! People with pacemakers should consult a physician and pacemaker manufacturer before welding. There is a potential for damage or serious malfunction resulting in death. High Frequency energy (HF)/Electromagnetic Fields generated during welding can interfere with pacemaker signals, even permanently damaging it. Some pacemakers offer some shielding, but restrictions regarding amperage and HF starting of TIG arcs may be placed upon the individual. Warn all potential bystanders that they should exit the work area if they have a pacemaker or similar medical equipment before welding. Severe electrical shock leading to injury or death may occur while using the plasma cutter if the user becomes part of the circuit path. While the Amp output of the plasma cutter is limited, the unit may produce an OCV of 300V or greater. Consult with a Physician if a pacemaker is expected to be implanted.</p>
	<p>DANGER! Never defeat or modify any safety guards or shields. Keep all safety covers and shields in place.</p> <p>Never place your fingers in or near a fan shroud or insert any object into the fan(s).</p>
	<p>DANGER! Always switch the Foot Pedal/Transmitter to the off position when not in use or when storing. Accidental activation may cause severe shock, arc flashing, burns or other injury or damage. This will also help to preserve the battery and keep it charged.</p>

Safety Warnings, Dangers, Cautions and Instructions

	<p>CAUTION! Trip Hazards exist around welders. Cords, cables, welding leads and hoses pose a trip hazard. Be aware of their location and inform others of their location. Tape and secure them so they will stay out of high traffic areas.</p>
	<p>CAUTION! Welded metal can stay hot long after welding is completed. Burns may occur. Always wear gloves or use tongs/pliers when handling welded or cut metal. Remember the heat from the metal may catch other material on fire. Always have a fire-proof area ready to place welded components until they fully cool. Use soap stone or a metal marking marker to label the metal as “HOT” to serve as a reminder to all present in the area.</p>
	<p>CAUTION! Welding and cutting operations generate high levels of ultraviolet (UV) radiation which can burn and damage skin and eyes. The intensity is so high that exposed skin and eyes can burn in a few minutes of exposure. Minimize direct skin and eye exposure to this intense form of radiation by using proper PPE and sun screen where appropriate.</p>
	<p>CAUTION! Do not allow bystanders. Do not allow others without proper Personal Protection Equipment (PPE) suitable for welding to stand in the welding area or to observe welding and welding related activities. If protection is not readily available, use a welding screen to separate the welding area from the rest of the area. If no protection or screen is available, physically exclude them from the welding area by a wall or other solid divider. Keep all pets and young children away from the welding area.</p>
	<p>IMPORTANT! This is an electronic device, which when properly designed may still occasionally cause undesirable interference. Electromagnetic Fields can be generated by this welding equipment and radiate into the work place which may disturb normal operation of other electronic devices. Keep pedal stored properly with the switch turned to off to prevent accidental transmission. If any electrical interferences is observed, discontinue use immediately and consult a qualified electrician or electronics expert to help isolate and remedy the cause of the problem by repositioning the receiver, or adding distance between the transmitter (pedal) and receiver (dongle). If notified by the FCC that this unit is causing electrical interference, you must discontinue use immediately.</p>
	<p>DANGER! Never touch connectors or fittings while this is connected to the welder and turned on. When storing the pedal, make sure the switch on the pedal is turned to off.</p>

Specifications

Pedal Parameters and Specifications

Specification	Receiver Dongle	Foot Pedal and Transmitter
Power Type	Adapter Input 100-240V 50/60Hz; .5A Adapter Output: 12V, 1A	Lithium Ion Rechargeable Pack
Weight	.78 lbs.	6.0 lbs.
Size	3.3"Lx3.3"Wx1.3"H	12"Lx7.9"Wx 4.1"H
Rated Operation Distance	Up to 100 ft.	Up to 100 ft
Number of pedals supported in one location	Up to 50 units	Up to 50 Units
Expected Charging Cycles of Battery*	Not Applicable. Dongle is powered by wall power.	Up to 300
Charge Duration**	NA	40 Days (8 Hour Shift)
Operation Frequency	2.4 Ghz	2.4 Ghz
Antenna Location	Internal	Internal
Recommended Operation Temperature***	14°F to 140°F /-10°C to 60°C	14°F to 140°F /-10°C to 60°C
Warranty	18 Months	18 Months

*The stated charging cycles are expected charging cycles based on lab and industry testing. Ultimately it depends upon battery storage, and operation temperatures and charging conditions. Extreme temperatures may reduce battery charging cycles that can be obtained. Improper battery cycling and charging techniques may also reduce battery life. This unit uses Lithium ion type batteries, and has the typical requirements of Lithium ion batteries.

**The duration of a single charge of the battery may vary depending upon actual use. The charge duration is based off of an average useage and expected time on of the foot pedal. Leaving foot pedal switched on in storage or while not in use will drain battery.

Model Compatibility For The NOVA Wireless Pedal

Adapter/Pedal Part #	TO FIT FOLLOWING MODEL NUMBER(S) / PART NUMBER(S)*
NVA-WL-FP200-AH07	AHP® and NOVA® 7Pin Alpha TIG 200X, 201XD, 225Xi, and 203XD with 7 Pins P/N: AHP-FP22NWI
NVA-WL-FP200-EB08A	ESAB® FirePower© Thermal Arc® 8 Pin (NOT FOR PEDAL WITH SWITCH) P/N: 10-4015, 10-4016, 600285, 1442-0025
NVA-WL-FP200-EB08B	ESAB (Rebel™ EMP 205ic AC/DC, EMP 215ic, EMP 235ic) P/N: W4014450
NVA-WL-FP200-EV07	Everlast® and NOVA® 7 Pin, Large, 22k and 47K. PowerTIG, PowerPro, PowerARC (models that are foot pedal capable only), PowerUltra, UltraARC. Some MTS with large 7 pin connection (verify size before purchasing) P/N: EV/NVA-FP22NWI, EV-FP50DL, EV-FP22DL
NVA-WL-FP200-EV07MTS	Everlast® and NOVA® 7 Pin, Small. MTS models, small connector (verify before purchase) Does not fit old MTS 160/200S. P/N: EV/NVA-FP22NWI-MTS, EV-FP47DL-MTS
NVA-WL-FP200-LN06	Lincoln® 6 Pin P/N: K870
NVA-WL-FP200-ML14	Miller® Hobart® 14 Pin Standard Model: RFCS-14 and RFCS-14HD P/N : 043554, 194744
NVA-WL-FP200-ML06	Miller® 6 Pin (Maxstar 161STL, 161STH, Multimatic 200) Model: RFCS-6M P/N: 195183 and 195504
Others	Call to Inquire. Specifications and availability subject to change.

*Disclaimer: NOVA is an independent brand and is not endorsed, guaranteed by, or manufactured by Miller, Lincoln or ESAB. All brand names are trademarked and mentioned are for selection purposes only.

Setup Guide

COMPONENT ID

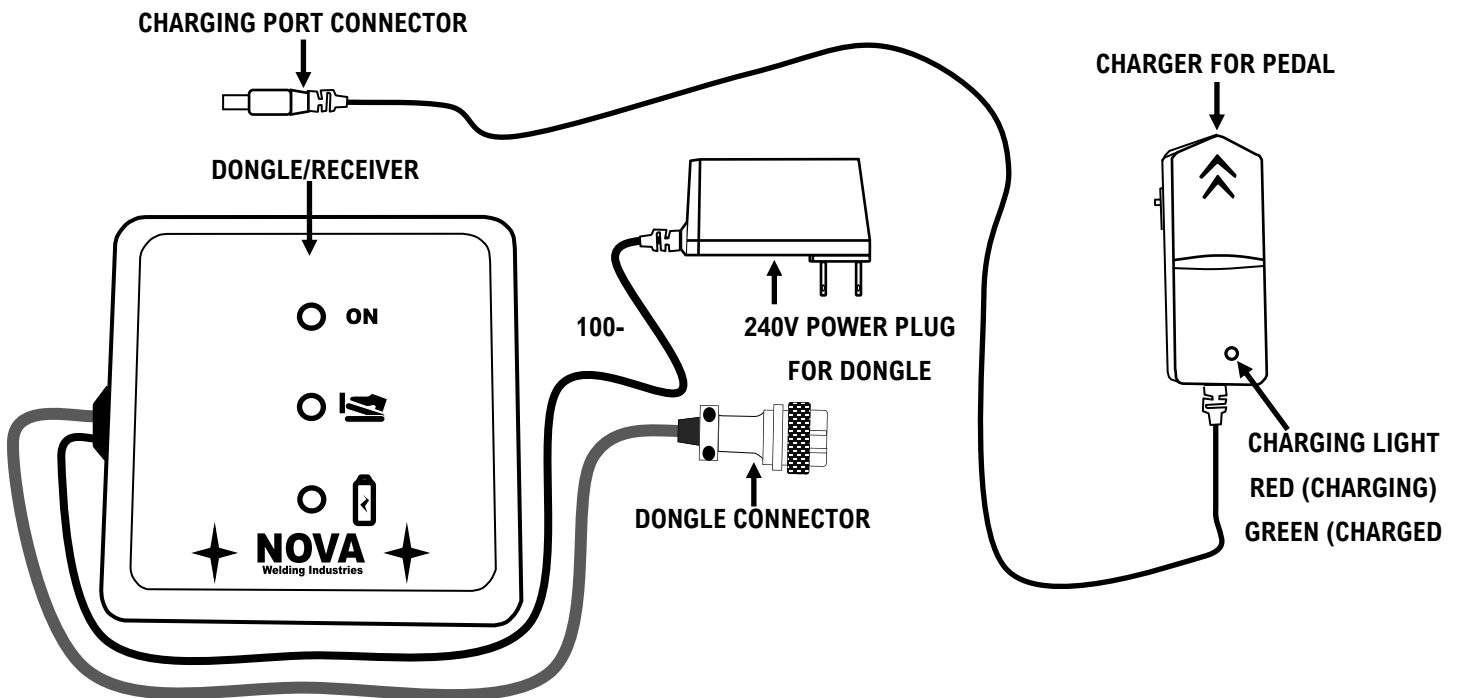
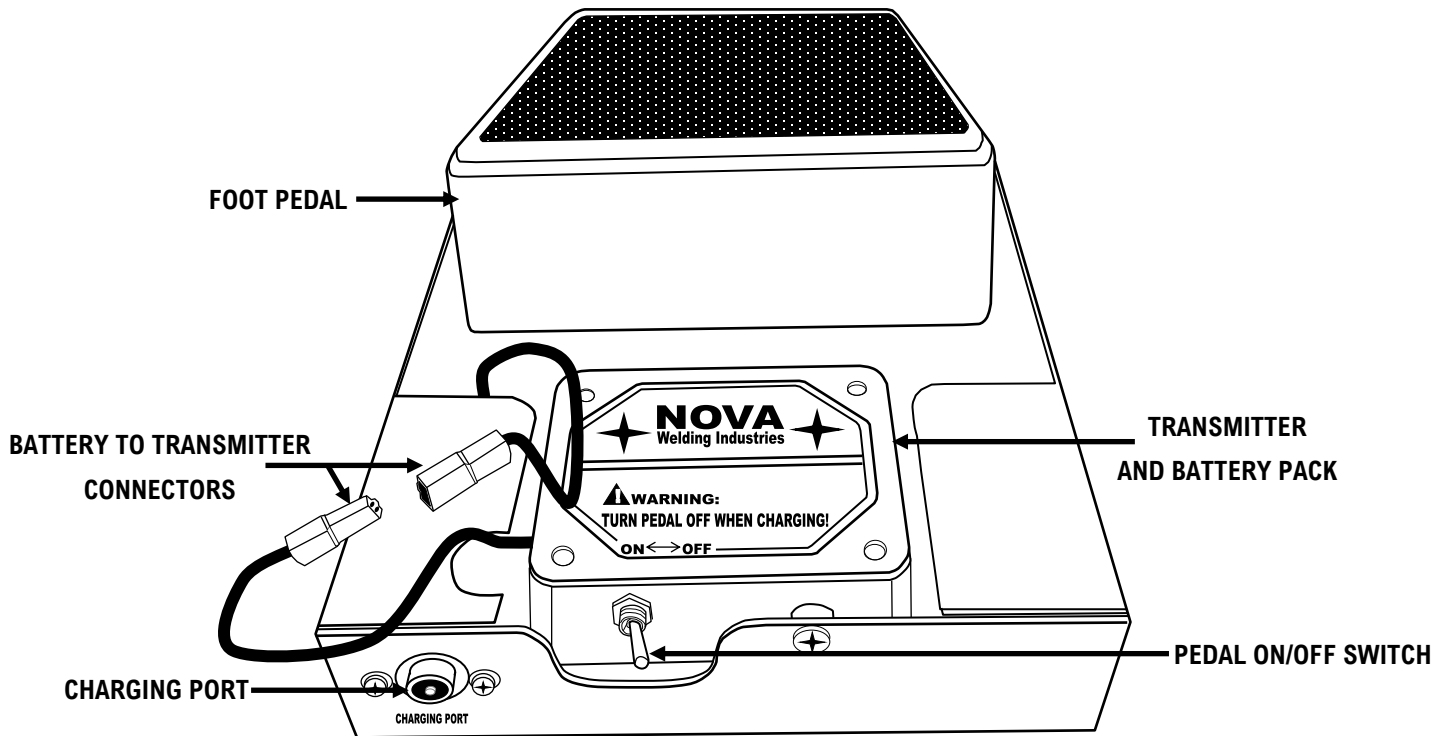

CONTROL ADAPTER FROM DONGLE CONNECTOR TO WELDER
(TYPE VARIES BY BRAND, NOT NEEDED FOR SOME APPLICATIONS)

Setup Guide

NOTICE:

The foot pedal may arrive with the top separated from the bottom. This is not damage. To install the top, flip the pedal spring under the cover to the forward position (towards transmitter end). Align the spring loaded pivot pins with the corresponding holes in the pedal top. The pins are spring loaded and can be squeezed so that the top slides down onto the pins. The pins will pop out into the holes and allow the top to pivot once the pins and holes are properly aligned. If resistance is felt or the pedal does not want to go together, you may need to make sure the pressure return spring is flipped so that it pushes back against the pedal as it is assembled. There will be moderate resistance as the pedal goes together, but it should be a firm, evenly felt resistance. Similarly, the foot pedal may be disassembled for adjustment by simply by pressing in on the ends of the pins with a dull awl, or Phillips type screw driver on both sides to remove the top. Once both pins have been pressed in, the pedal top should pop up for access to the foot pedal switch travel adjustment and other parts.

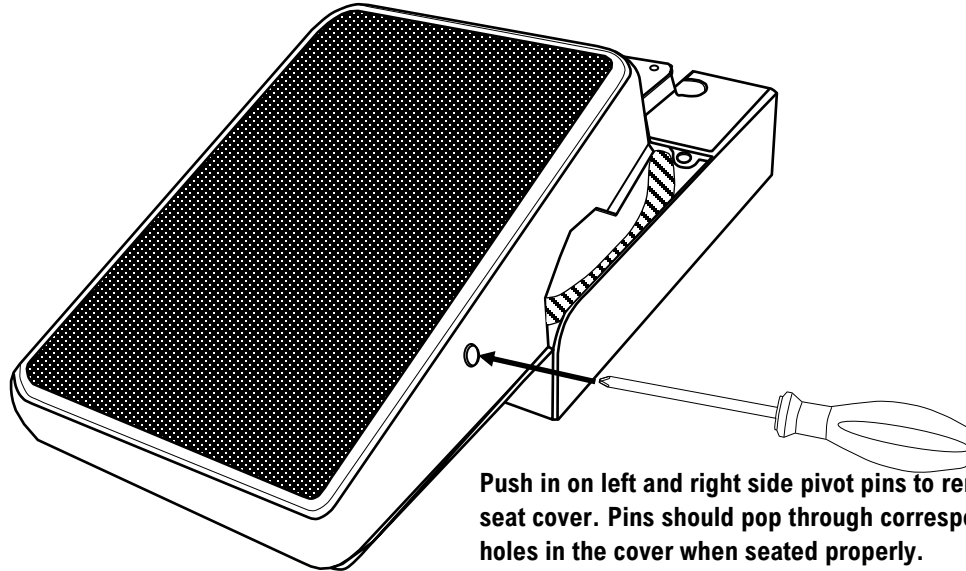

Setup Guide

Getting Started

UNPACK YOUR UNIT.

Upon arrival, you will need to completely unpack your foot pedal, and test it. It is important to identify any potential issues with your pedal. If any issue is noted, you should contact NOVA and resolve it immediately. The pedal is well packaged, but shipping damage can occur.

You should have the following in your box:

1. Wireless foot pedal with built-in transmitter.
2. Charger for pedal.
3. Receiver dongle (Machine side) with magnetic backing.
4. Adapter plug for the dongle to fit welder brand (exact adapter varies by brand) Not needed for Everlast MTS products.



When you receive your package, inspect the unit for damage. Check for the presence and general condition of the parts. Some slight rubbing or chaffing of some parts may be present, but this is considered normal. If any item is damaged or missing, please inform NOVA within 72 hours of product receipt. **NOTICE:** Shipping damage claims after 30 days may not be accepted unless extenuating circumstances exist such as overseas deployment, etc.

DESCRIPTION AND GENERAL OPERATION.

The NOVA Wireless pedal has been designed to operate on a common 2.4 Ghz wireless design which allows the pedal to be operated in an environment where multiple wireless NOVA pedals may be present. The design is aimed at preventing cross-talk between multiple units and accidental activation of the arc from another pedal. Long life Lithium-type batteries are used in the transmitter located in the pedal. These batteries are rechargeable and can be recharged up to 300 times or more. Each charge of the battery is capable of lasting up to 40 days on normal 8 hour shifts. The pedal is capable of operating and controlling the welder up to 100 feet away from the receiver mounted on the welder.

The pedal is used to both start the arc and incrementally control the up and down ramping of the Amperage from minimum to maximum selected Amperage. The maximum Amp output is governed by the

maximum Amp setting selected by the user on the welder control panel. Minimum start setting is governed by the welder default or start setting selected by the user.

NOTICE:

When the welder is set to high Amperages, the pedal will become more sensitive to Amperage change due to the change of ratio between the fixed pedal travel length and the Amp range it is required to control. When set to high maximum Amp settings, fine Amp control may be more difficult to achieve and the unit may seem to “accelerate” throughout the Amp range very quickly. When set to a very low maximum Amp setting, by comparison, the pedal will require more movement to make significant changes in Amperage and the rise and fall of Amperage will change more slowly throughout the range. At low maximum Amp settings, greater movement of the pedal may be required for a stable arc start at low Amps if starting Amperage is at or below the threshold of the Tungsten size used. This is not a pedal fault or flaw. It's the limitation of welding at low maximum Amp settings and incorrect Tungsten size.

PAIRING OF PEDAL AND RECIEVER.

The pedal arrives already paired (synchronized) to the receiver from the factory. There is no need to pair the pedal again unless a repair or replacement of the pedal or receiver has been done. The pedal can be paired again however in the event the pairing is lost.

Use the following directions only if pairing has been lost:

1. With the foot pedal switched to off, and the dongle/receiver disconnected from welder, connect the dongle/receiver to power source. (**NOTE:** The dongle does not need to be disassembled in this process.)
2. Disconnect all other receivers (dongles) in use in the facility.
3. Access the transmitter board depicted below by removing the 4 screws on the cover of the **transmitter box** located on the front of the foot pedal. (Do not remove board from pedal housing.)
4. Orient the board as shown to find the button(1) and the LED (2)
5. With the receiver on, press the button 1. The small LED (2) will light and should stay on constantly for a few moments.
6. The LED should begin to blink when the pairing link has been made. When the LED begins to blink, press button 1 again.
7. Press down on the foot pedal fully to complete the pairing.
8. Replace transmitter cover and check for proper operation.

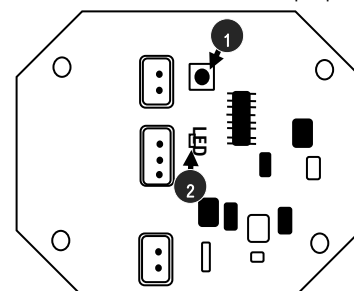

Setup Guide

Getting Started

CONNECT THE BATTERY WIRE.

The pedal is purposefully shipped with the wires from the lithium ion battery in the pedal to the transmitter disconnected for safety and to preserve the initial charge on the battery.

To Connect the Battery to the Transmitter:

- Match up the connector ends by pairing up the tabs on the connector and slide them fully together.
- Tuck the wire down beside the transmitter.
- Do not leave the wires or the connectors sticking out. The gap beside the transmitter allows room for both the wire and connectors to be pushed down beside the transmitter.

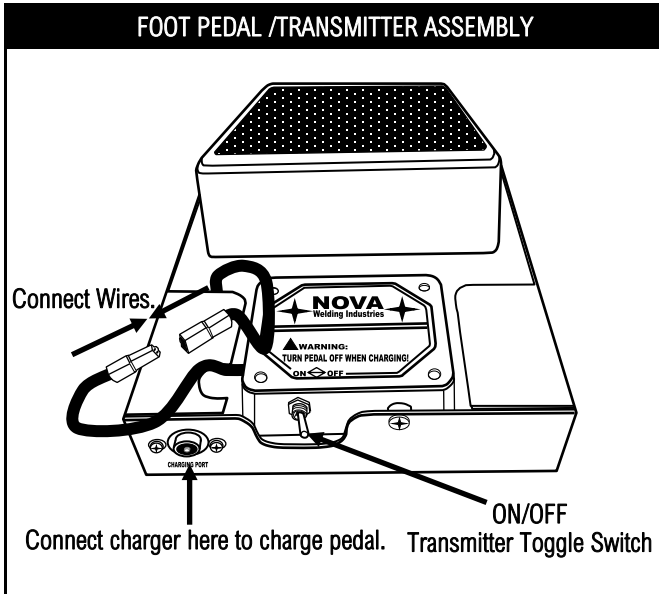

CHARGE THE BATTERY

The battery carries a charge from the factory that was used to pair the transmitter and receiver. However, before use, the battery should be charged. Each charge can last up to 40 days between charges with average use on 8 hour shifts. If the pedal acts irregularly, or the Dongle/Receiver indicates a low battery charge recharge the battery.

To Recharge the Battery:

- Set the transmitter toggle switch on the front of the pedal to the "OFF" position. (See Foot Pedal/Transmitter Assembly Diagram.)
- Locate the charger in the packaging. (See Foot Pedal Charger Diagram.)
- Connect the charger to the charging port on the front of the pedal.
- Plug the charger into a suitable 120V (100-240V permissible)

receptacle.

- The LED light at the bottom of the charger will turn red.
- Charge for at least 4 hours until the LED turns from red to green.
- Once the LED turns green, remove the charger.
- Keep the pedal switched to "OFF" until the pedal is ready for use. Remember to turn the switch to "OFF" position when not in use or when stored to preserve battery life and prevent accidental operation of the pedal.

DANGER!

When left unattended, when work is completed, or when the pedal is otherwise not being used for welding purposes such as in transporting or carrying, turn the pedal/transmitter switch to the "OFF" position to prevent accidental activation. Shock, burn, arc flashing and/or injury could result from accidental activation of the pedal. Damage to high value parts may result as well if torch is left on work and the pedal is accidentally activated and an arc starts.

FOOT PEDAL CHARGER (100-240V)

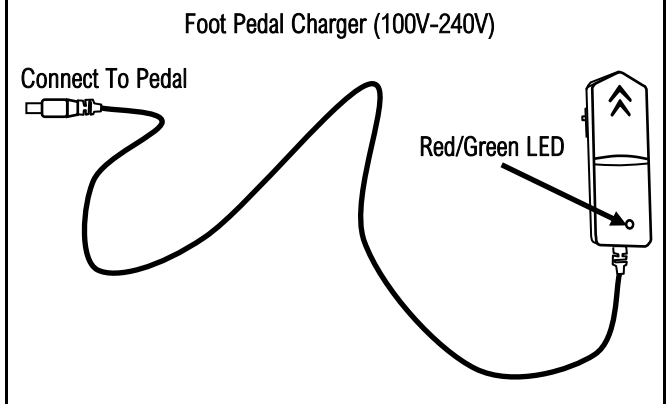

IMPORTANT!

Charge the pedal only when the toggle switch is placed in the off position. Do not use the pedal with the charger connected. Keep the pedal stored with the switch in the "OFF" position to prevent discharge of the batteries. As a "best practice" switch the pedal switch to the "OFF" position whenever the pedal is not be used or left unattended to prevent accidental arcing.

CONNECT THE RECEIVER DONGLE TO WELDER.

The Receiver/Dongle assembly requires 100-240V power to operate. In the North American Market, this will typically be used with a standard NEMA 5-15 120V outlet. The Dongle may be powered with an

Setup Guide

Getting Started

extension cord if the outlet is not near the welder, but be mindful that there is an additional trip hazard.

To connect the Dongle:

- Turn on welder power.
- Switch the Foot Pedal/Transmitter to “OFF”.
- Locate a magnetic surface on the welder or nearby work surface and attach the Dongle via the hidden magnet located on the back side of the dongle housing.
- Locate the correct Dongle Adapter and connect it to the Dongle connector.
- Connect Dongle to machine control/remote terminal of the welder. (This is the normal location for the foot pedal or remote.)
- Plug Dongle into the power source (100 to 240V). The “On” LED should be lit. North American standard is 120V, NEMA 5-15R
- Switch the Foot Pedal/Transmitter to “ON”.
- The NOVA Wireless pedal is now ready for use.

turned on. The wireless nature of the pedal means that the pedal operates best by line of site. Large obstructions, walls, and significant metal structures in the path of transmission will likely interfere with pedal operation. After charging initially, and following the “Getting Started” directions in the previous information, the pedal will be ready for use.

To operate the wire less pedal:

- Confirm the welder is turned on.
- Confirm the dongle is plugged in and receiving power.
- Confirm the foot pedal has been switched on.
- Select the “Pedal” function of your welder, or appropriate setting that you would use with your welder when using a foot pedal.
- Select the maximum Amperage you wish to use with the pedal.
- Set your welder normally as you would with any foot pedal, including start settings, tungsten diameter etc. for best starts.
- Press lightly on the pedal until you hear/feel a slight click. This will start the arc. Pressing further down will increase the Amperage. Raising the pedal will decrease the Amperage. You can continue to modulate the Amperage throughout the entire range by varying the pedal position.
- To stop the arc, smoothly raise your foot off the pedal so that it completely goes back to the pre-start position.
- If you maintain pressure on the pedal, the arc will not terminate until the pedal is fully released back to the pre-start position.

There are a couple of additional pieces of information that will help you to understand the function of the pedal, transmitter, and receiver.

- The Dongle includes 3 LED lights. See diagram, next page.
- The top green LED (1) indicates the dongle is receiving power.
- The middle LED (2) will light and flash red as the pedal is in use. (This is used as a diagnostic to confirm the dongle is receiving signal as well when the pedal is pressed.)
- The bottom LED (3) will light if the Dongle senses a weak battery. If this happens stop and charge the battery on the foot pedal/transmitter as soon as possible. Do not attempt to completely run down the battery or battery life will be shortened.
- The Dongle must have a power source. It is not battery operated. It can be powered by voltage ranging from 100V-240V.
- Unplug the Dongle when not in use. The Dongle does not have an ON/OFF switch.

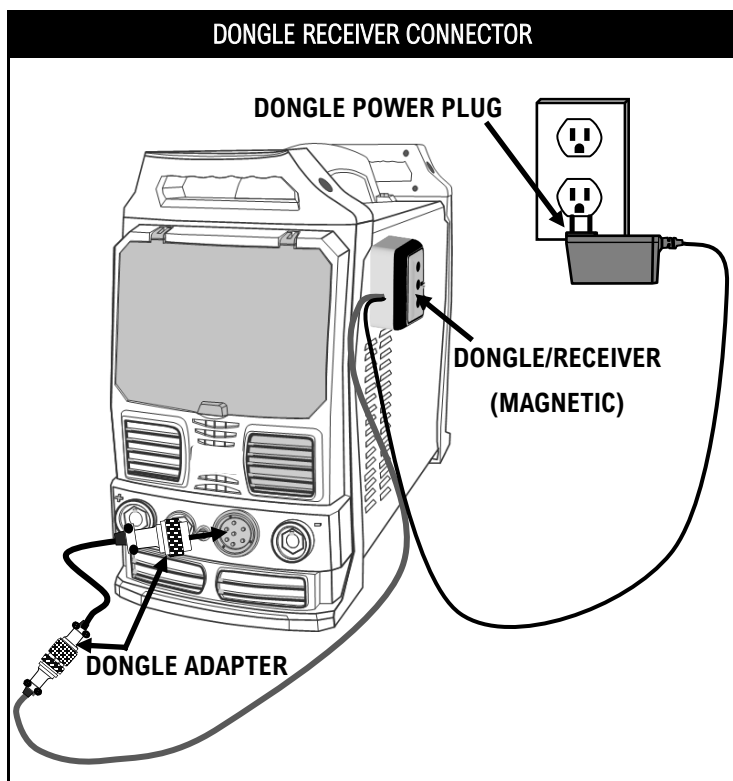

OPERATION OF THE NOVA WIRELESS PEDAL.

The NOVA wireless pedal operates simply and accurately. It is already paired with the receiver so it is ready to go when connected and

Setup Guide

Getting Started

- Not all units require an adapter. If the supplied adapter does not fit your welder, contact NOVA as soon as possible. Not all welders can be used with the NOVA wireless pedal. Older, non-digitalized welders will often not be able to work with this unit. If in doubt, consult the NOVA product compatibility information on the specifications page, or contact NOVA directly before purchase.

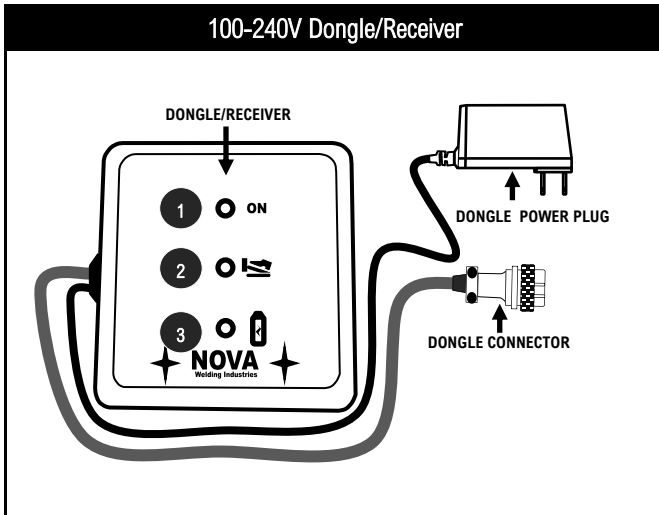

Setup Guide

Troubleshooting

Trouble	Cause/Solution
Welder does not respond when pedal is activated	<p>Battery charge is too low. Check Dongle indicator, Recharge battery.</p> <p>Dongle is not plugged in. Plug in Dongle.</p> <p>Foot pedal transmitter is switched off. Turn switch on</p> <p>Battery to transmitter wires are unplugged, Plug wires into each other .</p> <p>Wrong mode selected on welder. Set to proper mode such as "Pedal".</p>
Welder reacts sluggishly or irregularly and arc lights irregularly or is delayed	<p>Battery charge is low. Check Dongle indicator. Recharge battery.</p> <p>Obstruction. Remove obstruction. Operate line-of-sight.</p> <p>Too far away from receiver. Move closer.</p>
Arc is shut off suddenly and reinitates.	<p>HF point gap (if used) is incorrect, or HF starting device is emitting too much High Frequency at start.</p>
Arc does not shut off cleanly or properly	<p>Improper machine settings. Turn off down slope.</p> <p>Pedal is not fully back to stop. Press on rear of pedal to make sure the pedal is in the fully up position and the micro switch is not being activated.</p> <p>Microswitch is out of adjustment. Remove cover and make sure microswitch is adjusted so that there is no contact when pedal top and the microswitch when in fully up position.</p>
Arc cuts out or doesn't seem stable as pedal is swept up or down. Response is not as expected. (Wired pedal operates normally.)	<p>Interference. Turn off all other electronics in shop one at a time to isolate.</p> <p>Bad potentiometer or broken internal wires on the pedal. Contact NOVA</p>
Another foot pedal is controlling the welder.	<p>Foot pedal has been improperly paired, or lost pairing. This should not normally happen unless the pedal has been worked on or replaced. Follow repairing instructions in this manual. Contact NOVA.</p> <p>If another brand, is interfering, discontinue use of the other pedal and contact NOVA.</p>