



Superun | 
TREADMILL FOR HOME
MANUAL



MAKE YOUR LIFE HEALTHIER

TABLE OF CONTENTS

▼

01.Installation Instructions	01
02.Safety Precautions	02
03.Warm-up	03
04.Products And Accessories	04
05.Function Diagram	06
06.Using The Treadmill	08
07.Installation Steps	10
08.Installation Instructions	12
09.common Faults And Handling Methods	16

01. INSTALLATION INSTRUCTIONS

▼ Welcome to use Help you enjoy exercising at home

Specification

Specifications: CT04

Product Size: 55.5*28*5.2inches

Product weight: 68.3LBS

Peak horsepower: 3.0HP

Running belt size: 42.3*16.5inches

Rated voltage: 120V

Maximum load: 300LBS

Maximum speed: 7.5MPH

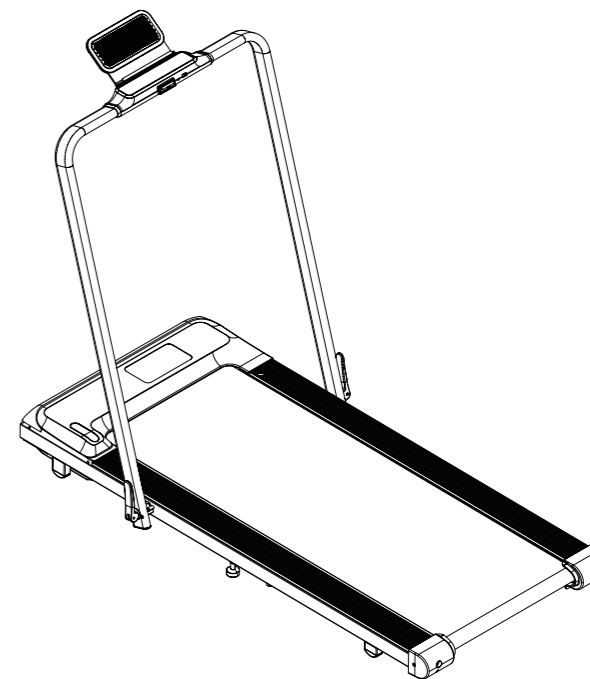

02. SAFETY PRECAUTIONS

✓ Please read all instructions carefully before operating this product.

Basic precautions should always be followed when using the device, including the following safety instructions:

- Please do not use the machine when you are sick, tired or drunk.
- Please wear comfortable clothes and avoid flip-flops or skirts when using this machine.
- Please start from suitable sport as excessive exercise may affect health.
- Load capacity 300LBS, overload may cause damage.
- Please ensure that all parts are not damaged and fixed before use. The device should be placed on a flat surface when used.
- Do not attempt any maintenance or adjustments other than those described in this manual.
- The device is for home use only. Do not use the device in a commercial, rental, or institutional environment.
- Only one person is allowed to use the device.
- Keep children and pets away from the device when using it.
- If you experience any chest pain, nausea, dizziness, or shortness of breath, stop exercising immediately and consult your doctor before continuing.

03. WARM-UP

✓ Sports suggestions and guidelines

WARNING! Before beginning this or any exercise program, you should consult your physician. Warming up prepares the body for the exercise by increasing circulation, supplying more oxygen to the muscles and raising body temperature. Begin each workout with 5 to 10 minutes of stretching and light exercise to warm up. The photos on this page show several forms of basic stretching you may perform before your workouts. In order to achieve an adequate warm-up, perform each stretch three times.



1.Stretch down:

Bend your knees slightly with your body stretch down slowly, let your back and shoulders relax, and try to extend your hands to touch your toes. Hold for 10–15 seconds and take a break for a few seconds. Repeat 3 times.

2.Hamstring stretch:

Sit down on a clean cushion, straighten one leg and place the other leg inward towards the thigh and snug on the inside of the straightened leg. In the meantime, try to touch the toes of your straightened leg with the hand at the same side. Hold for 10–15 seconds and take a break for a few seconds. Repeat 3 times for each leg.

3.Calf and Achilles Tendon Stretches:

Place both hands against the wall while standing with one foot behind the other, keeping your back leg straight and both heels planted on the ground while leaning against the wall. Hold for 10–15 seconds and take a break for a few seconds. Repeat 3 times for each leg.

4.Quadriceps Stretch:

Hold your body steady with your left hand holding against the wall and right hand reaching back to grab your right heel and pull it slowly towards your hips, until you feel the muscle tightness at the front side of your thigh. Hold for 10–15 seconds and take a break for a few seconds. Repeat several times for each leg.

5.Sartorius (muscle of inner thigh) Stretch:

Sit on the floor with your two feet holding against each other and your knees pointing to the opposite directions, grab your feet with your hands and pull them toward your groin. Hold for 10–15 seconds and take a break for a few seconds. Repeat 3 times.





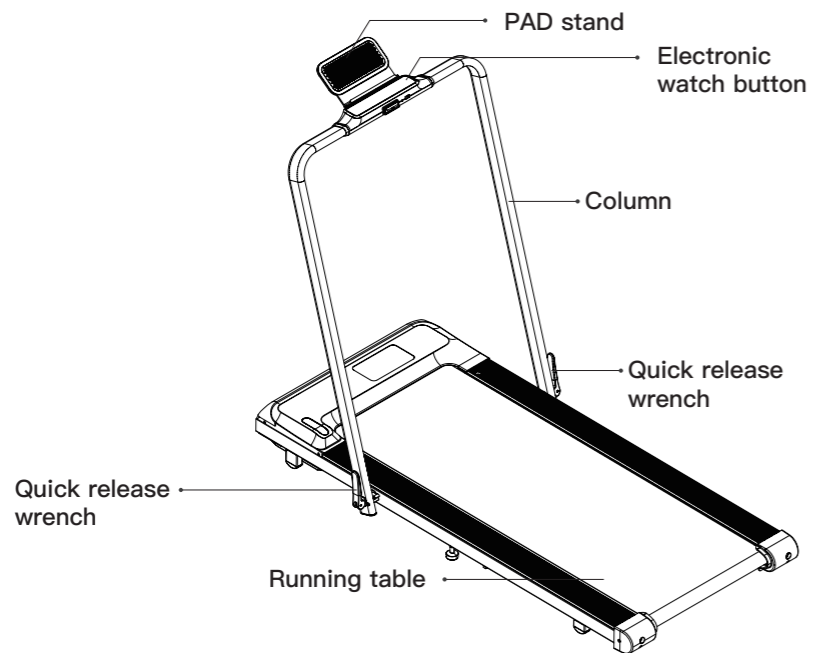

04. PRODUCTS AND ACCESSORIES



√ Product introduction



04. PRODUCTS AND ACCESSORIES

Packing Details

No.	Parts	
1	Main Frame	
2	Phone Stand	
3	Manual	
4	Power Cord	
5	Screw Package	
6	Smart Bracelet	
7	Remote control	

No.	Parts	
1	Safety Lock	1 piece
2		1 piece
3		1 piece

05. FUNCTION DIAGRAM

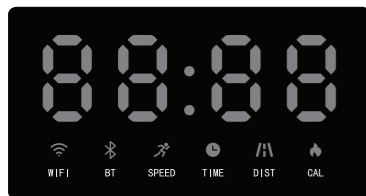

^

When the machine is running, the display window automatically switches every 5 seconds. The indicator light at the bottom of the lull window changes with the display of the window. The information displayed in different Windows is as follows:

(1). "Speed" window

The current speed value is displayed in the running state, and the speed is on. The display range is 1–7.5mph.

- (1) When the column pillar is open, the maximum speed is 7.5mph
- (2) When the column pillar is closed, the maximum speed is 3.8 mph

(2). "Time" window

Display exercise time. The time range is 0:00–99:59 minutes, Maximum display 18h.

(3). "Distance" window

Display the moving distance, the display range is 0.00–9999mp miles, the reverse count is decremented from the set value to zero, when the counter turns to 0, the machine will steadily descend to stop.

(4). "Calories window"

Display the calorie consumption value, the display range is 0.0–9999 kcal.

The reverse count is decremented from the set value to zero, when the counter turns to 0, the machine will steadily descend to stop.

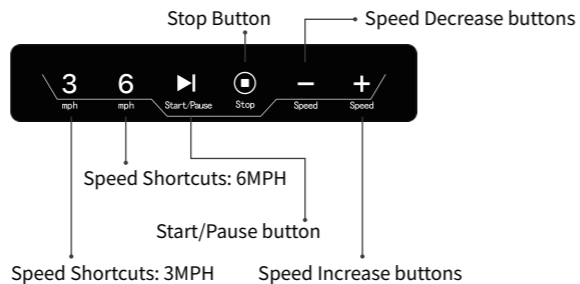

05. FUNCTION DIAGRAM

- WIFI indicator
- Bluetooth indicator
- Speed Display
- Time Display
- Distance Display
- Calorie Display

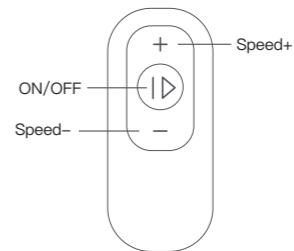

Remote control

- (1). Press the "Speed -" key to reduce the machine speed.
- (2). Press "Speed +" to increase the speed of the machine.
- (3). Press the "ON/OFF" button, and the machine will start or stop slowly.

1. In the standby state, directly press the "ON/OFF" button, the treadmill would start to move at the speed of 0.2 miles/hr, other windows start counting up from 0, press "+", "-" button to change the speed.

Unmanned Shutdown:

In the operating state of the treadmill, if the treadmill detects an unmanned state for more than 10s, it will automatically stop.

06.USING THE TREADMILL



Note: System requirements:
ios13 or above ; android 6.0
or above.

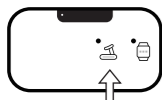

After registration, click the treadmill icon in the upper right corner



01 Waiting for the treadmill to connect

02 Searching for Wifi

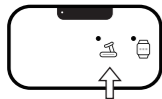

Display “Green” to complete the connection

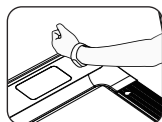

Link bracelet

08

5.

Treadmill supports connection to mobile phone via Bluetooth

1.Download PitPat app on your phone and install it Search for “PitPat” in the app store or scan the following QR code to download and install the app.

2. Configure PitPat app account Open PitPat app and follow the app instructions to log in or register account information

3. Connect the treadmill

(1) Turn on the Bluetooth function of the mobile phone (the android mobile phone also needs to turn on the positioning function)

(2) Open the PitPat app (if the app prompts for authorization, please grant the app related permissions)

(3) Enter the app home page, click the treadmill icon in the upper left corner of the home page to enter the search interface,
your phone will automatically search for nearby devices. Tap your treadmill (devices starting with PitPat-T are your treadmills) to connect.

After the treadmill makes a beep, the connection is successful, and the Bluetooth icon on the treadmill panel lights up.

Note: Please make sure your phone is connected to the Internet when connecting the treadmill via Bluetooth

Please refer to the APP description for detailed networking configuration

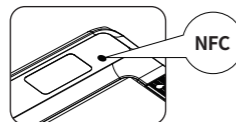

06.USING THE TREADMILL



Note: If the treadmill is not connected to the mobile app, the Bluetooth icon of the treadmill is off; if the treadmill is successfully connected to the mobile app, the Bluetooth icon of the treadmill is on

Sleep function description:

When the treadmill stops running and there is no operation for more than 4 minutes, it will enter the sleep state. The electronic watch will automatically turn off the display. Press any key to wake up the electronic watch, and then enter the initial standby state again after full display.

6.

Treadmill WIFI network configuration

After the treadmill is successfully connected to the mobile app, it will enter the treadmill WIFI configuration interface.

Note: The treadmill only supports 2.4GHZ WIFI (the app also only displays the 2.4GHZ WIFI signal that the treadmill can search for), please make sure that your network device can provide 2.4GHZ WIFI signal

(1) Find the network you need to connect to

(2) Enter your WIFI password according to the prompt. After the treadmill successfully connects to the network, the WIFI icon on the treadmill panel lights up and the app will return to the home page.

Note: If the WIFI connection fails, after the WIFI returns to normal, please restart the treadmill so that it can reconnect to the Internet

5.Connect the bracelet to the treadmill

Turn on the treadmill, put the screen of the bracelet on the NFC logo of the treadmill, the treadmill make a sound of “bleep”, and the bracelet is connected with the treadmill.

Once the bracelet is successfully bound, it will recording your running information immediately.

09

07. INSTALLATION STEPS

Installation steps

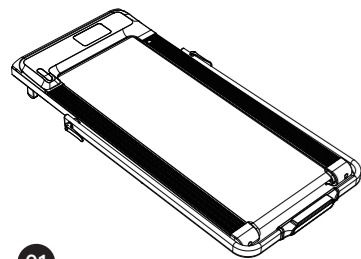

01

Open the package, take out the assembly material in the box and lay the main unit flat on the ground.

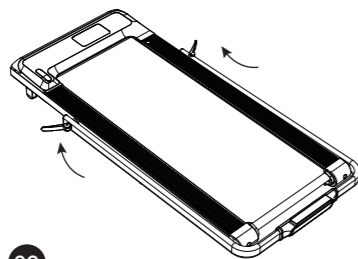

02

Wrench open the quick release wrench and wrench it in the direction shown by the arrow, (as shown in the figure below).

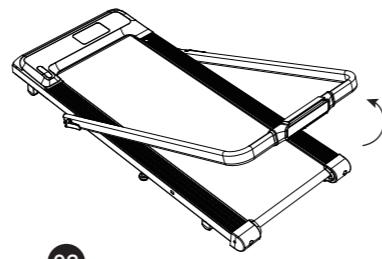

03

erect the column in the direction of the arrow.

07. INSTALLATION STEPS

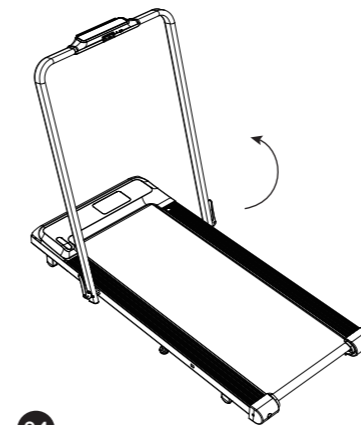

04

Fasten the quick release wrench after the column is erected in place to achieve column fixation.

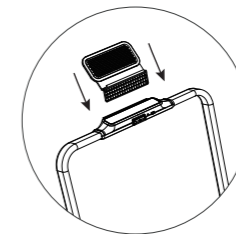

05

Insert the PAD frame.

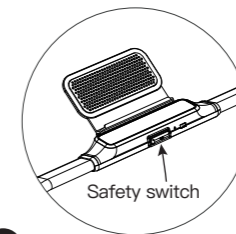

06

electronic table yellow sticker position put on the safety switch, power can operate the treadmill operation.

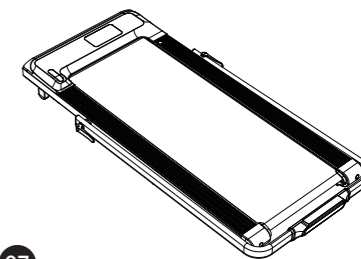

07

column down and restart the machine, the speed is 0.6 ~ 3.8mph. (remote control)
(Reminder: walk when the PAD frame do not inserted in the electronic table button shell)

08. INSTALLATION INSTRUCTIONS

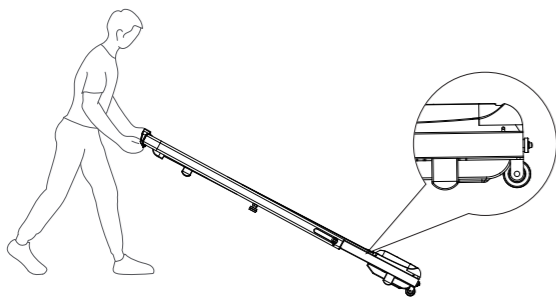

1. First, adjust the foot pads, and place them on flat ground and make sure there is a space of 50cm in front and rear.

2. Connect the power supply, turn on the switch.

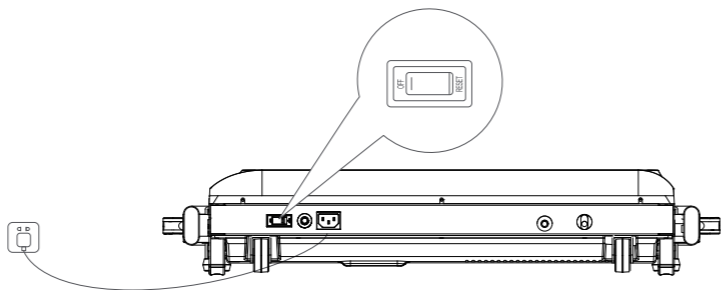

08. INSTALLATION INSTRUCTIONS

v



3. First check and install the battery, press the "ON/OFF" button, there would be 3 seconds delay displayed on the panel before operating.

4. Start using a walking treadmill.

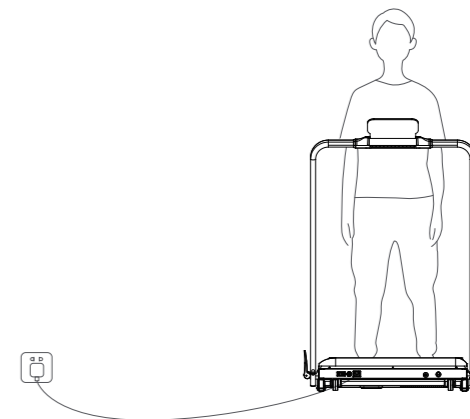

08. MAINTENANCE INSTRUCTION

▼ Slip and correction of walking belt

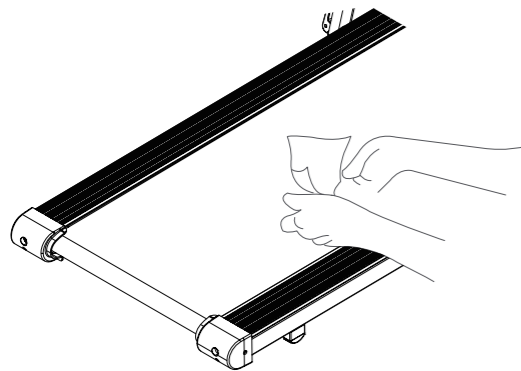

1. Clean the treadmill

- Turn off the machine and unplug the power cord
- Apply a mild cleaner to a cotton cloth.
- Do not spray the cleaner directly on the walking belt
- Do not wipe under the walking belt

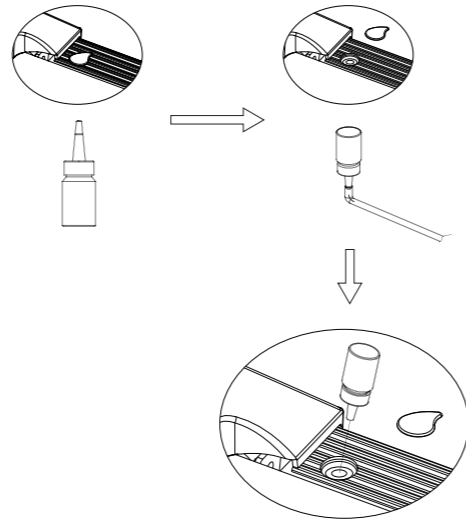

2. Walking belt lubrication

- Turn off the walking machine and unplug the power cord
- Lift the edge of the walking belt and smear the inner surface with silicone oil
- Start the walking treadmill and run at 3mph for 10–20 seconds before use
- The walking belt should be lubricated every one month

08. MAINTENANCE INSTRUCTION

▼

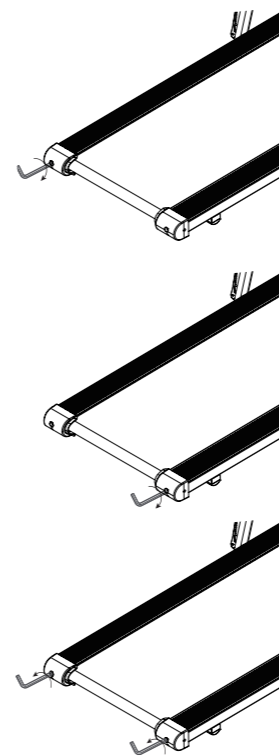

1. When running belt leans to the left, adjusting screw on the left 1–2 turns clockwise. Then, test running; If the running belt still leans to the left, repeat the above steps until the running belt is aligned.

2. When running belt leans to the right, adjusting screw on the right 1–2 turns clockwise. Then, test running; If the running belt still leans to the right, repeat the above steps until the running belt is aligned.

3. When the running belt gets too tight it will cause stronger resistance. Please adjust both sides screws 1–2 turns counterclockwise, loosen the belt until stopping skidding or pausing; When the running belt too loose, please adjust both sides screws 1–2 turns along the clockwise.

09.COMMON FAULTS AND HANDLING METHODS

Er1: indicates that the electronic meter and electronic control communication abnormal phenomenon prompt

Er1 solutions to common problems	The communication line of the electronic meter is not connected, broken, poor contact	Please reconnect the communication line
	No signal output of electronic meter	Replace the electronic meter, to be repaired
	No signal output of the lower control	Replace the lower control, to be repaired

Er3: indicates that the lower control detects the motor over-voltage protection information prompt

Er3 solutions to common problems	Walker load exceeds the rated working voltage of the motor	Recommended to use within the rated working voltage of the motor
	Walking machine motor abnormal / due to light sensor failure caused by speed too fast	Replace the motor / replace the photoelectric sensor
	Lower control board over-voltage detection circuit failure	Replace the lower control, pending repair

Er4: indicates that the lower control detects the motor overcurrent protection information prompt

Er4 solution to common problems	The load of the walker exceeds the rated working current of the motor	Recommended to be within the rated operating current of the motor
	Walking machine and motor assembly structure problems, resulting in motor resistance or blocking phenomenon	Check the walking machine structure is normal
	Lower control current limiting system failure	Replace the lower control, pending repair

09.COMMON FAULTS AND HANDLING METHODS

Er5: indicates that the lower control detects the motor overload abnormal phenomenon prompt

Er5 common problem solution	The current is too high during the continuous time	Please check whether the power supply line is normal
	Lower control board detection line failure	Replace the lower control, pending maintenance

Er6: Indicates that the lower control detects the abnormal phenomenon of speed

Er6 solutions to common problems	Motor line is not connected properly	Reassemble
	The lower control board detection line failure or motor damage (no sense mode)	Replace the lower control or motor, pending repair

Er7: The controller does not receive signal

Er7 or - common problem solution	The communication line of the electronic meter is not connected, broken, poor contact	Please reconnect the communication line
	Lower control board detection line failure	Replace the lower control, pending repair

Er99: Unmanned Shutdown

Er 99	In the operating state of the treadmill, if the treadmill detects an unmanned state for more than 10s, it will automatically stop.
-------	--

TABLE OF CONTENTS

v

01. instrucciones de instalación	18
02. precauciones de Seguridad	19
03. precalentamiento	20
04. productos y accesorios	21
05. mapa funcional	23
06. uso de la cinta de correr	25
07. pasos de instalación	29
08. instrucciones de instalación	31
09. fallas comunes y tratamientos	33

01. INSTRUCCIONES DE INSTALACIÓN

v Bienvenido a usarlo para ayudarlo a disfrutar del ejercicio en casa

Especificaciones

Especificaciones: CT04

Tamaño del producto: 55.5 * 28 * 5.2 pulgadas

Peso del producto: 68.3 LBS

Potencia máxima: 3.0 HP

Tamaño de la correa de transmisión: 42.3 * 16.5 pulgadas

Tensión nominal: 120V

Carga máxima: 300LBS

Velocidad máxima: 7.5 MPH

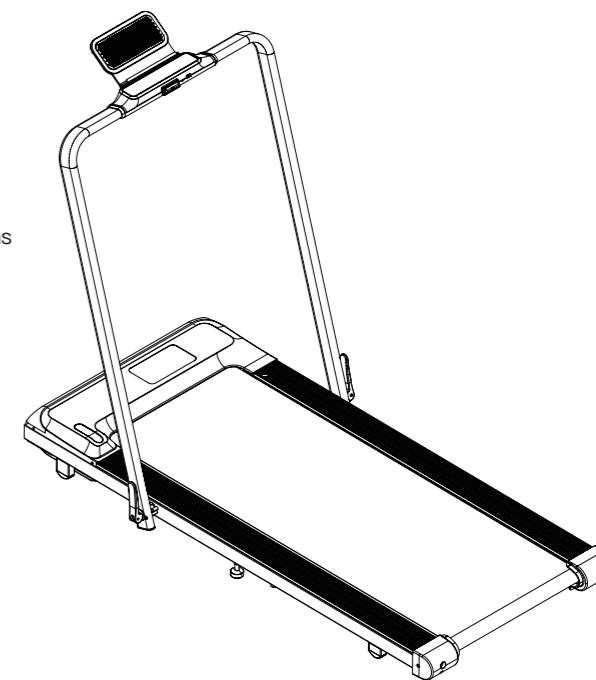

02. PRECAUCIONES DE SEGURIDAD

✓ Lea atentamente todas las instrucciones antes de utilizar este producto.

Siempre se deben seguir las precauciones básicas al usar el dispositivo, incluyendo las siguientes instrucciones de seguridad:

- Por favor, no utilice la máquina cuando esté enfermo, cansado o borracho.
- Por favor, use ropa cómoda y evite las chanclas o faldas cuando use esta máquina.
- Por favor, comience con un deporte adecuado, ya que el ejercicio excesivo puede afectar la salud.
- Capacidad de carga 300LBS, la sobrecarga puede causar daños.
- Asegúrese de que todas las piezas no estén dañadas y reparadas antes de su uso. El dispositivo debe colocarse sobre una superficie plana cuando se use.
- No intente ningún mantenimiento o ajuste que no sea el descrito en este manual.
- El dispositivo es solo para uso doméstico. No utilice el dispositivo en un entorno comercial, de alquiler o institucional.
- Solo una persona puede usar el dispositivo.
- Mantenga a los niños y mascotas alejados del dispositivo cuando lo use.
- Si experimenta dolor en el pecho, náuseas, mareos o dificultad para respirar, deje de hacer ejercicio de inmediato y consulte a su médico antes de continuar.

03. PRECALENTAMIENTO

✓ Sugerencias y directrices deportivas

Orientación para el ejercicio

ADVERTENCIA! Antes de comenzar este o cualquier programa de ejercicios, debe consultar a su médico.

El calentamiento prepara el cuerpo para el ejercicio aumentando la circulación, suministrando más oxígeno a los músculos y elevando la temperatura corporal. Comience cada entrenamiento con 5 a 10 minutos de estiramiento y ejercicio ligero para calentar. Las fotos en esta página muestran varias formas de estiramiento básico que puede realizar antes de sus entrenamientos. Para lograr un calentamiento adecuado, realiza cada estiramiento tres veces.

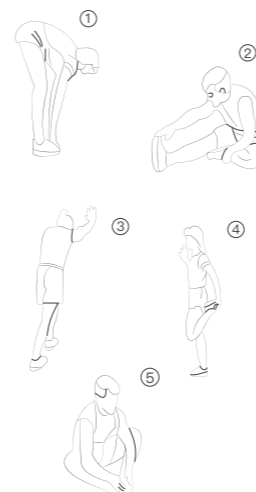

1. Estirar hacia abajo:

Bend your knees slightly with your body stretch down slowly, let your back and shoulders relax, and try to extend your hands to touch your toes. Hold for 10–15 seconds and take a break for a few seconds. Repeat 3 times.

2. Estiramiento de los isquiotibiales:

Sit down on a clean cushion, straighten one leg and place the other leg inward towards the thigh and snug on the inside of the straightened leg. In the meantime, try to touch the toes of your straightened leg with the hand at the same side. Hold for 10–15 seconds and take a break for a few seconds. Repeat 3 times for each leg.

3. Estiramientos de la pantorrilla y del tendón de Aquiles:

Place both hands against the wall while standing with one foot behind the other, keeping your back leg straight and both heels planted on the ground while leaning against the wall. Hold for 10–15 seconds and take a break for a few seconds. Repeat 3 times for each leg.

4. Estiramiento de cuádriceps:

Hold your body steady with your left hand holding against the wall and right hand reaching back to grab your right heel and pull it slowly towards your hips, until you feel the muscle tightness at the front side of your thigh. Hold for 10–15 seconds and take a break for a few seconds. Repeat several times for each leg.

5. Estiramiento del sartorio (músculo de la cara interna del muslo):

Sit on the floor with your two feet holding against each other and your knees pointing to the opposite directions, grab your feet with your hands and pull them toward your groin. Hold for 10–15 seconds and take a break for a few seconds. Repeat 3 times.





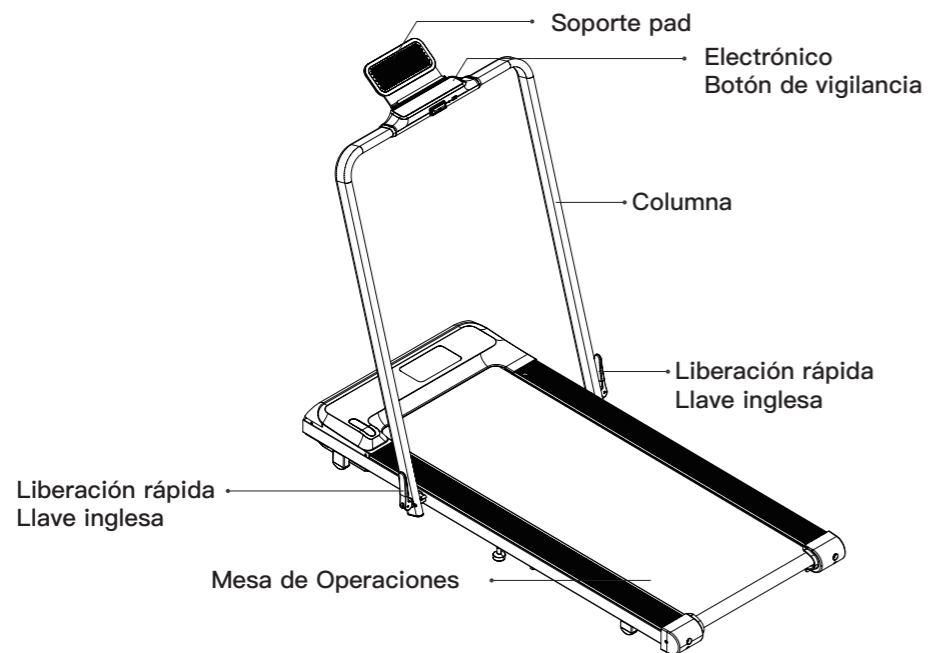

04. PRODUCTOS Y ACCESORIOS



✓ Introducción del producto



04. PRODUCTOS Y ACCESORIOS

Detalles del embalaje

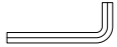
No.	Parte	
1	Marco principal	
2	Soporte para teléfonos móviles	
3	Manual	
4	Línea de alimentación	
5	Componentes de tornillo	
6	Pulsera inteligente	
7	Control remoto	

No.	Parte	
1	Safety Lock	1 pieza
2		1 pieza
3		1 pieza

05. MAPA FUNCIONAL

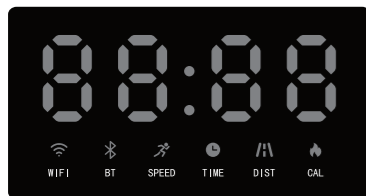

^

Quando la máquina está funcionando, la ventana de visualización cambia automáticamente cada 5 segundos. La luz indicadora en la parte inferior de la ventana luli cambia con la visualización de la ventana.

La información que se muestra en diferentes Windows es el siguiente:

(1). Ventana de "velocidad"

El valor actual de la velocidad se muestra en estado de funcionamiento, la velocidad está abierta. el rango de visualización es de 1 – 7,5 mph.

- (1) la velocidad máxima es de 7,5 MPH cuando se abre la columna
- (2) la velocidad máxima es de 3,8 MPH cuando la columna está cerrada

(2). Ventana "Tiempo"

Muestra el tiempo de ejercicio. El rango de tiempo es de 0: 00 a 99: 59 minutos, y el tiempo máximo de visualización es de 18 horas.

(3). Ventana "Distancia"

Muestre la distancia móvil, el rango de visualización es de 0.00 a 99.99 millas, el recuento inverso se reduce del valor establecido a cero, cuando el contador gira a 0, la máquina descenderá constantemente para detenerse.

(4). "Ventana de calorías"

Muestra el valor de consumo de calorías, el rango de visualización es 0.0–9999 kcal.

El conteo inverso se decrementa desde el valor establecido hasta cero, cuando el contador llega a 0, la máquina descenderá constantemente hasta detenerse.

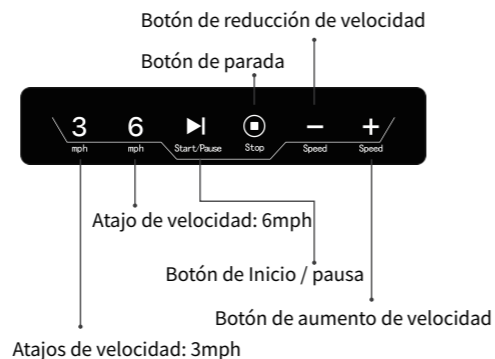

05. MAPA FUNCIONAL

- Indicador wifi
- Indicador Bluetooth
- Pantalla de velocidad
- Visualización del tiempo
- Pantalla de distancia
- Visualización de calorías

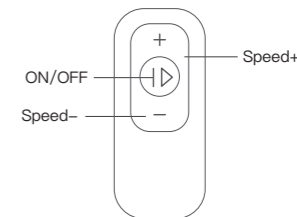

Control remoto

- (1). Pulse la tecla "Velocidad -" para reducir la velocidad de la máquina.
- (2). Presione "Velocidad +" para aumentar la velocidad de la máquina.
- (3). Presione el botón "ON/OFF" y la máquina comenzará o se detendrá lentamente.

1. En el estado de espera, presione directamente el botón "ENCENDIDO/APAGADO", y la cinta de correr comenzará a moverse a una velocidad de 0,2 millas/hora, otras ventanas comienzan a contar desde 0, presione "+", "-" botón para cambiar la velocidad.

Estado de la cinta de correr: cuando se levanta el reposabrazos, el equipo es una cinta de correr, que solo se puede controlar a través del botón de resorte, y el interruptor de seguridad funciona normalmente.

Estado del paseo: cuando el reposabrazos se acuesta, el equipo es un paseo, que solo se puede controlar a través del control remoto, y el interruptor de Seguridad no restablece la cinta de correr.

▲ Parada no tripulada:

En el Estado de funcionamiento de la cinta de correr, si la cinta de correr detecta un Estado no tripulado durante más de 10 segundos, se detendrá automáticamente.

06. USO DE LA CINTA DE CORRER



Nota: Requisitos del sistema: ios13 o superior; Android 6.0 o superior.

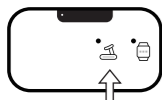

Después de registrarse, haga clic en el icono de la cinta de correr en la esquina superior derecha



01 esperando la conexión de la cinta de correr

02 buscar wifi

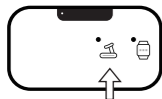

Mostrar "verde" para completar la conexión

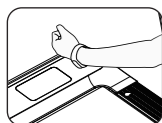

Pulsera de enlace

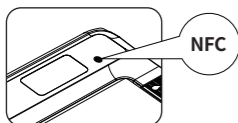

NFC

5.

La cinta de correr admite la conexión al teléfono móvil a través de Bluetooth

1. Descargue la aplicación PitPat en su teléfono e instálela. Busque "PitPat" en la tienda de aplicaciones o escanee el siguiente código QR para descargar e instalar la aplicación.

2. Configure la cuenta de la aplicación PitPat. Abra la aplicación PitPat y siga las instrucciones de la aplicación para iniciar sesión o registrar la información de la cuenta.

3. Conectar la cinta de correr

(1) Encienda la función Bluetooth del teléfono móvil (el teléfono móvil Android también necesita encender la función de posicionamiento)

(2) Abra la aplicación PitPat (si la aplicación solicita autorización, conceda los permisos relacionados con la aplicación)

(3) Ingrese a la página de inicio de la aplicación, haga clic en el icono de la caminadora en la esquina superior izquierda de la página de inicio para ingresar a la interfaz de búsqueda, su teléfono buscará automáticamente los dispositivos cercanos.

Toque su cinta de correr (los dispositivos que comienzan con PitPat-T son sus cintas de correr) para conectarse.

Después de que la máquina para correr emita un pitido, la conexión es exitosa y el icono de Bluetooth en el panel de la máquina para correr se enciende.

Nota: asegúrese de que su teléfono esté conectado a Internet cuando conecte la cinta de correr a través de Bluetooth

Consulte la descripción de la aplicación para la configuración detallada de la red

06. USO DE LA CINTA DE CORRER



Nota: Si la caminadora no está conectada a la aplicación móvil, el icono de Bluetooth de la caminadora está apagado; si la cinta de correr se conecta con éxito a la aplicación móvil, el icono de Bluetooth de la cinta de correr está encendido

6.

Configuración de la red WIFI de la cinta de correr

Después de que la cinta de correr se haya conectado con éxito a la aplicación móvil, ingresará a la interfaz de configuración WIFI de la cinta de correr.

Nota: La cinta de correr solo admite WIFI de 2,4 GHz (la aplicación también solo muestra la señal de WIFI de 2,4 GHz que la cinta de correr puede buscar), asegúrese de que su dispositivo de red pueda proporcionar una señal de WIFI de 2,4 GHz

(1) Encuentra la red a la que necesitas conectarte

(2) Ingrese su contraseña WIFI de acuerdo con el aviso. Después de que la máquina para correr se conecte con éxito a la red, el icono WIFI en el panel de la máquina para correr se ilumina y la aplicación volverá a la página de inicio.

Nota: Si la conexión WIFI falla, después de que WIFI vuelva a la normalidad, reinicie la máquina para correr para que pueda volver a conectarse a Internet.

5. Conecta la pulsera a la cinta de correr.

Encienda la cinta de correr, coloque la pantalla de la pulsera en el logotipo NFC de la cinta de correr, la cinta de correr emite un sonido de "bip" y la pulsera se conecta con la cinta de correr.

Una vez que el brazalete se haya enlazado con éxito, registrará su información de ejecución de inmediato.

06. USO DE LA CINTA DE CORRER

Pasos de instalación

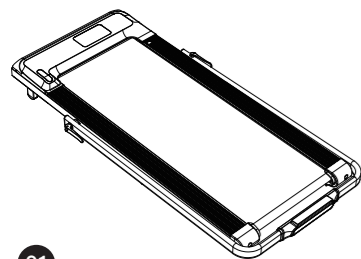

01

Abra el embalaje, retire el material de montaje de la Caja de embalaje y coloque el motor principal plano en el suelo.

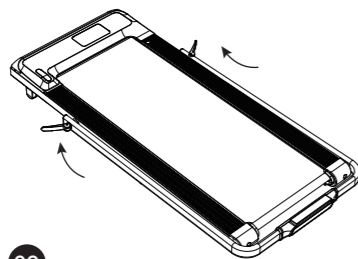

02

Abra la llave de liberación rápida con una llave inglesa y apriete en la dirección mostrada por la flecha (como se muestra en la siguiente imagen).

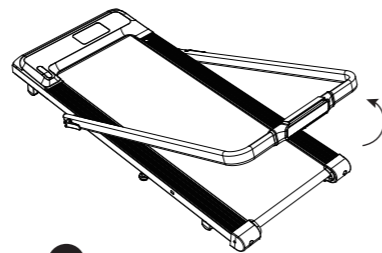

03

Erigir los pilares en la dirección de la flecha.

06. USO DE LA CINTA DE CORRER

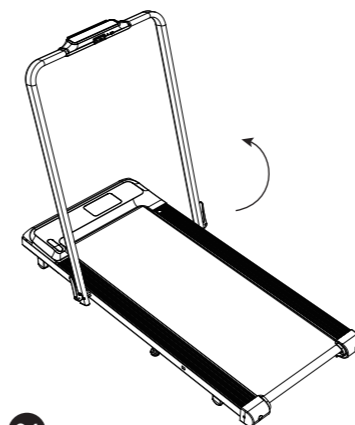

04

Después de que el poste esté instalado en su lugar, apriete la llave de liberación rápida para lograr la fijación del poste.

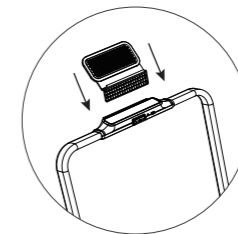

05

Inserte el marco pad.

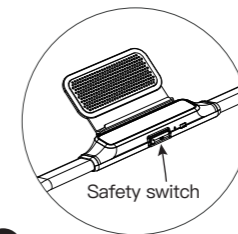

06

La posición de la pegatina amarilla de la Mesa electrónica se coloca en el interruptor de seguridad, y la fuente de alimentación puede operar la cinta de correr.

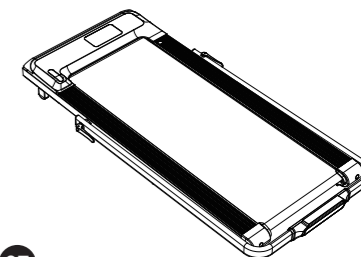

07

(control remoto) (recordatorio: camine cuando el marco PAD no esté insertado en la carcasa del botón de la Mesa electrónica)

07. PASOS DE INSTALACIÓN

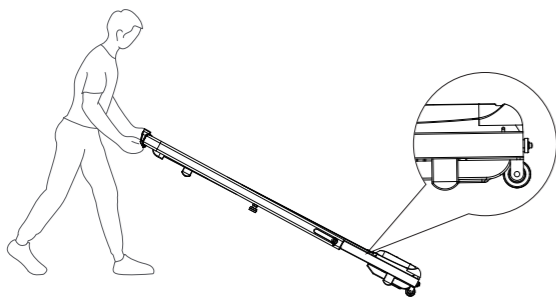

1. Primero, ajuste las almohadillas de los pies y colóquelas en plano aterriz y asegurese de que haya un espacio de 50 cm en delantera y trasera.

2. Conecte la fuente de alimentación, encienda el interruptor.

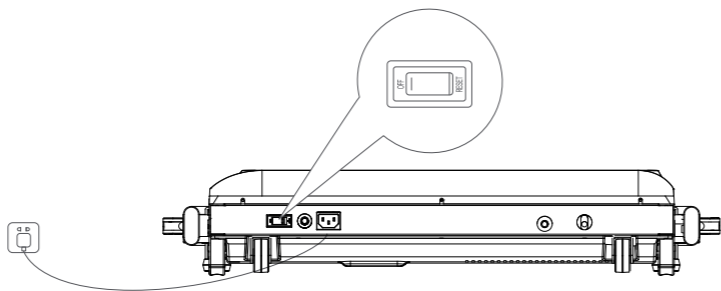

07. PASOS DE INSTALACIÓN

v

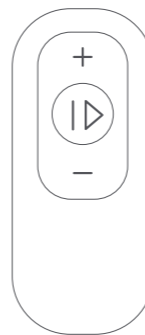

3. Primero verifique e instale la batería, presione el botón "ON / OFF", la máquina ingresa a la cuenta regresiva de 3 segundos.

4. Comienza a usar un treadmill para caminar

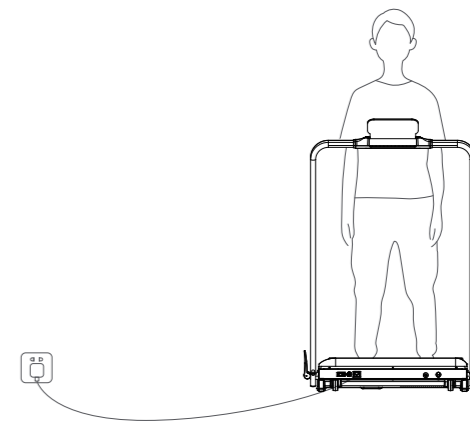

08. INSTRUCCIONES DE INSTALACIÓN

√ Slip and correction of walking belt

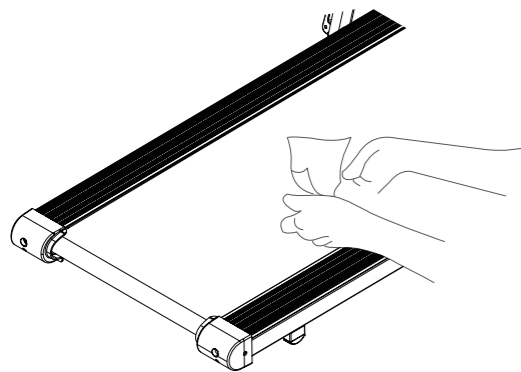

1. Clean the treadmill

- Turn off the machine and unplug the power cord
- Apply a mild cleaner to a cotton cloth.
- Do not spray the cleaner directly on the walking belt
- Do not wipe under the walking belt

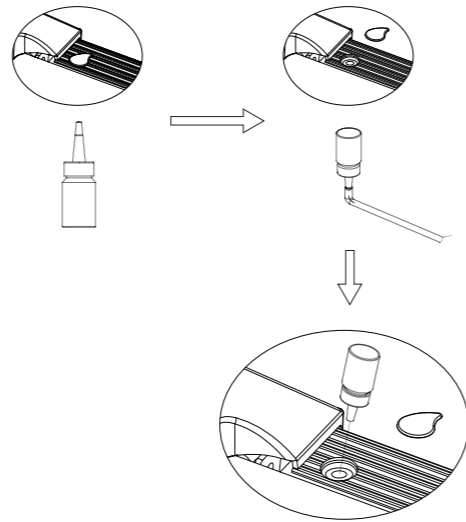

2. Walking belt lubrication

- Turn off the walking machine and unplug the power cord
- Lift the edge of the walking belt and smear the inner surface with silicone oil
- Start the walking treadmill and run at 3mph for 10–20 seconds before use
- The walking belt should be lubricated every one month

08. INSTRUCCIONES DE INSTALACIÓN

√

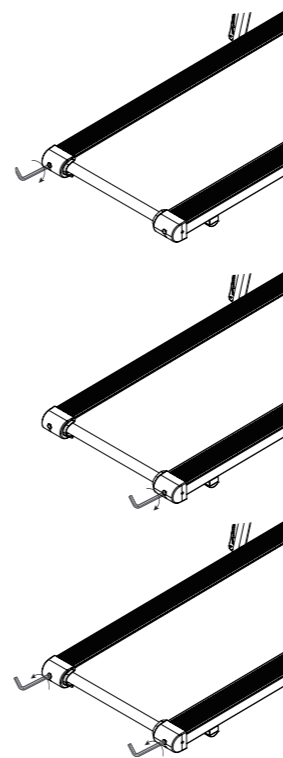

1. When running belt leans to the left, adjusting screw on the left 1–2 turns clockwise. Then, test running; If the running belt still leans to the left, repeat the above steps until the running belt is aligned.

2. When running belt leans to the right, adjusting screw on the right 1–2 turns clockwise. Then, test running; If the running belt still leans to the right, repeat the above steps until the running belt is aligned.

3. When the running belt gets too tight it will cause stronger resistance. Please adjust both sides screws 1–2 turns counterclockwise, loosen the belt until stopping skidding or pausing; When the running belt too loose, please adjust both sides screws 1–2 turns along the clockwise.

09. FALLAS COMUNES Y TRATAMIENTOS

Er1: indica consejos sobre fenómenos anormales en la comunicación entre instrumentos electrónicos y control eléctrico

Soluciones er1 Preguntas frecuentes	La línea de comunicación del instrumento electrónico es No conectado, desconectado, mal contacto	Por favor, reconecte la línea de comunicación
	Salida sin señal del instrumento electrónico	Reemplazo de instrumentos electrónicos por reparar
	ontrol inferior sin salida de señal	Reemplazar el dispositivo de control inferior, por reparar

Er3: indica que el control inferior ha detectado un aviso de información de protección de Sobretensión del motor

Soluciones er3 Preguntas frecuentes	La carga de viaje supera la tensión de trabajo nominal Motor	Recommended to use within the rated working voltage of the motor
	El motor de la máquina de caminar es anormal / debido a la luz La velocidad excesiva provoca un fallo en el sensor	Reemplazar el motor / reemplazar el sensor fotoeléctrico
	Detección de sobrepresión en el panel de control inferior Falla del circuito	Reemplazar el dispositivo de control inferior y esperar la reparación

Er4: indica que el control inferior ha detectado un aviso de información de protección de sobrecorriente del motor

Solución de er4 a Preguntas frecuentes	La carga del andador supera la carga de trabajo nominal Corriente eléctrica del motor	Se recomienda dentro del rango de corriente de trabajo nominal Motor
	Estructura de montaje de la máquina de caminar y el motor Problemas que provocan resistencia o bloqueo del motor Fenómeno	Comprobar si la estructura del mecanismo de caminar es normal
	falla del sistema de restricción de flujo de control inferior	Reemplazar el dispositivo de control inferior y esperar la reparación

09. FALLAS COMUNES Y TRATAMIENTOS

Er5: indica que el control inferior detecta un fenómeno anormal de sobrecarga del motor.

Er5 ordinario Solución al problema	Corriente excesiva durante el tiempo continuo	Por favor, compruebe si el cable de alimentación es normal.
	El panel de control inferior detecta fallas en la línea	Reemplazar el dispositivo de control inferior y esperar el mantenimiento

Er6: indica que se detecta una anomalía de velocidad bajo control

Soluciones er6 Preguntas frecuentes	La línea del motor no está conectada correctamente	Reensamblaje
	El panel de control inferior detecta una falla en la línea o Daños en el motor (modo sin sensores)	Reemplazar el dispositivo de control inferior o el motor a la espera de reparaciones

Er7: el controlador no recibe la señal

Er7 o – General Solución al problema	La línea de comunicación del instrumento electrónico es No conectado, desconectado, mal contacto	Por favor, reconecte la línea de comunicación
	El panel de control inferior detecta fallas en la línea	Reemplazar el dispositivo de control inferior y esperar la reparación

Er99: parada no tripulada

Er 99	En el Estado de funcionamiento de la cinta de correr, si la cinta de correr detecta un Estado no tripulado durante más de 10 segundos, se detendrá automáticamente.
-------	---

FCC Statement

This equipment has been tested and found to comply with the limits for a Class B digital device, pursuant to part 15 of the FCC Rules. These limits are designed to provide reasonable protection against harmful interference in a residential installation. This equipment generates, uses and can radiate radio frequency energy and, if not installed and used in accordance with the instructions, may cause harmful interference to radio communications. However, there is no guarantee that interference will not occur in a particular installation. If this equipment does cause harmful interference to radio or television reception, which can be determined by turning the equipment off and on, the user is encouraged to try to correct the interference by one or more of the following measures:

- Reorient or relocate the receiving antenna.
- Increase the separation between the equipment and receiver.
- Connect the equipment into an outlet on a circuit different from that to which the receiver is connected.
- Consult the dealer or an experienced radio/TV technician for help.

Caution: Any changes or modifications to this device not explicitly approved by manufacturer could void your authority to operate this equipment.

This device complies with part 15 of the FCC Rules. Operation is subject to the following two conditions: (1) This device may not cause harmful interference, and (2) this device must accept any interference received, including interference that may cause undesired operation.

RF Exposure Information

This equipment complies with FCC radiation exposure limits set forth for an uncontrolled environment. This equipment should be installed and operated with minimum distance 20cm between the radiator and your body.