



purO₂xygen

purOxygen

P500i

Smart HEPA
Air Purifier

USER'S GUIDE

Thank you for choosing PUROXYGEN P500i!

P500i HEPA Air Purifier cleans out the air around you from dust, odors and more. As indoor air is becoming increasingly polluted, it is crucial to arm yourself with an air purifier able to ensure proper air cleaning.

1. Air Purifier
2. Combination Filter
3. User's Guide









3



PRODUCT STRUCTURE

1. Air outlet
2. Control panel/Display area
3. Buckle/Handle
4. Sensor
5. Middle frame
6. Front panel
7. Air inlet

DISPLAY AND TOUCH CONTROL PANEL

-  **POWER (short press)** - turn on/off the unit
-  **POWER (press for 4 sec when the unit is on)** - turn on Wi-Fi
-  **SPEED** - 3 fan speeds and Auto Mode
-  **SLEEP** - turn off the light and the machine runs at low speed - low noise
-  **TIMER** - choose 1-12 hours to turn on/off the machine
-  **TIMER - press and hold for 3 seconds** - reset the filter replacement timer

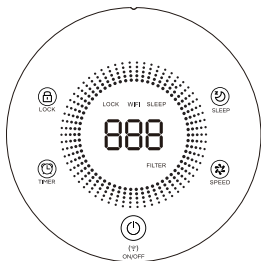
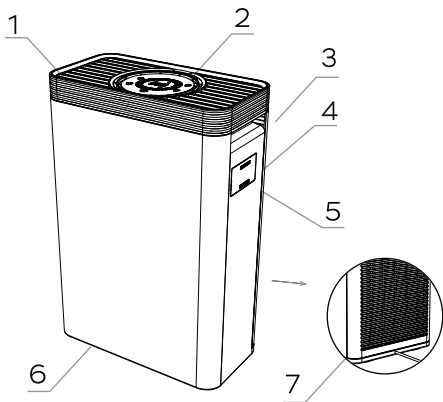

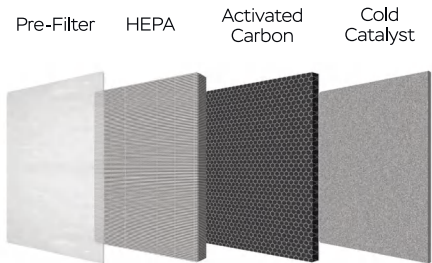

CORE FILTRATION SYSTEM

The **P500i** filtration system consists of 4 purification stages: pre-filter, HEPA, activated carbon and cold catalyst.



20dB

Tick of the clock



35dB

Ambient sound of baby's sleep



55dB

P500i Fast wind speed mode



65dB

Office ambient sound



70dB

Ambient sound during discussion



85dB

Car exhaust

NOISE LEVEL

While the **P500i** model works at all available fan speeds, **PUROXYGEN** takes care of the low noise level in it.

PM2.5 DIGITAL DISPLAY

The **PUROXYGEN P500i** is equipped with the PM2.5 sensor to inform a user about the concentration of PM in the air. The PM concentration is shown with digits and also divided by 4-color light indications:



– Excellent Air Quality - Green light indication



– Good Air Quality - Blue light indication.

Yellow
Medium Air Quality



– Medium Air Quality - Yellow light indication.

Red
Poor Air Quality



– Poor Air Quality - Red light indication.

HOW TO START

The new **PUROXYGEN P500i** already comes with the combination filter inside it.

1. Open the filter cover and take off the polybag containing the combination filter.
2. Remove the combination filter from the polybag.
3. Put the combination filter into the purifier with the blue side tagged as “FRONT” facing towards you.
4. Close firmly the filter cover.
5. Connect the power plug to a power source.
6. Press the **POWER** button on the purifier’s control panel.
7. The purifier will start working. You will see the 30 seconds countdown, after which the LED light indication (green, blue, yellow or red depending on the air quality) and altering digits standing for the air pollution index will appear on the control panel.

Note:

When placing the unit, make sure to allow at least 4 inch (10 cm) clearance between the air inlet/outlet and any obstacle.



FAN SPEEDS

The inbuilt fan can operate at 3 speeds and in Auto Mode. To change the fan speed, use the **SPEED** button on the purifier's control panel.

1 speed - 350 rpm

2 speed - 550 rpm

3 speed - 800 rpm

To enable Auto Mode, press the **SPEED** button on the purifier's control panel several times until you see the "A" indication.

In the Auto Mode, the fan speed is set automatically, according to the air quality readings obtained from the PM2.5 sensor.



SLEEP MODE

The **PUROXYGEN P500i** has Sleep Mode which allows the purifier to operate at the lowest fan speed with the lowest noise emission and no LED indication.

To enable/disable it, press the **SLEEP** button on the purifier's control panel.



TIMER

The **PUROXYGEN P500i** can turn on/off automatically in a particular period of time (1-12 hours).

To enable the ON timer, when the purifier is OFF, press the **TIMER** button on the purifier's control panel. Each button press adds one hour. To enable the OFF timer, please do the same steps but when the purifier is ON.

To disable the timer, press the **TIMER** button on the purifier's control panel several times until you see the **-h** LED indication (for OFF timer) or until the display turns off (for ON timer).



CHILD LOCK

You can disable the buttons on the purifier's control panel by using Child Lock.

To enable/disable it, press and hold the **LOCK** button on the purifier's control panel for 3 seconds.

WI-FI CONTROL

The **P500i** purifier is equipped with the Wi-Fi feature compatible with almost all popular Smart Home Kits (Google, etc.).

To start using it:

1. Download the Smart Life app using the following QR code (available for Android and iOS) and open it:



2. Log in or Sign up to use all the features of this app:

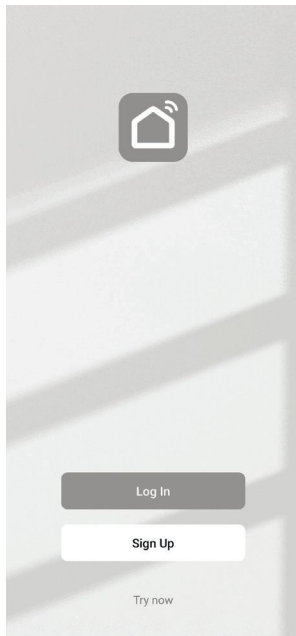

3. On the Home tab, tap on Add Device:

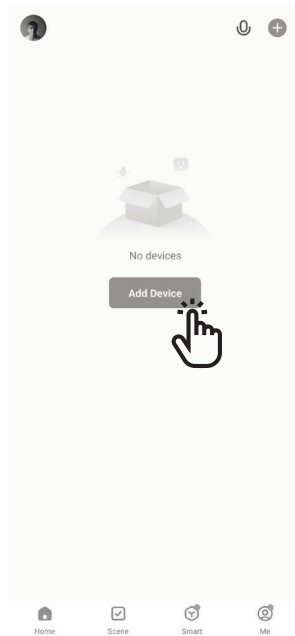

4. Read the tips through (if any):



5. Give all the required permissions to the app:

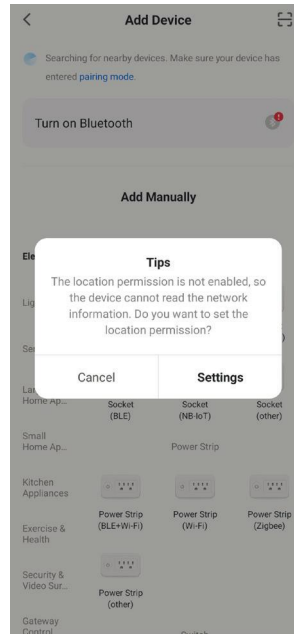

6. In the list on the left, select Small Home Appliances, and in the list on the right, select Air Purifier (Wi-Fi):

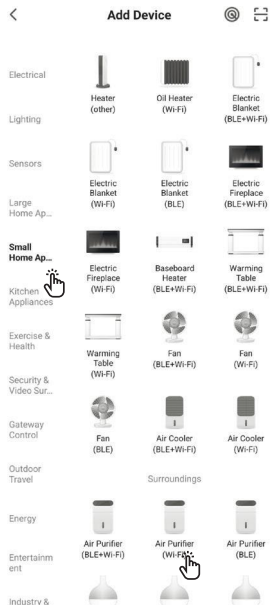

7. In the next screen, select the Wi-Fi network you want to connect the purifier in and enter the password to this network.

Please note that the purifier supports only 2.4GHz Wi-Fi networks, it will not connect to the app if 5Ghz network is used:

Select 2.4 GHz Wi-Fi Network and enter password.

If your Wi-Fi is 5GHz, please set it to be 2.4GHz.
Common router setting method

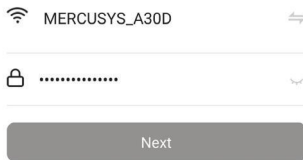
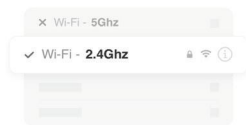

8. After that, when the purifier is on, press and hold the **POWER** button on the purifier's control panel until you hear the sound prompt and the WIFI LED starts flashing:



9. In the app, confirm that you entered the Wi-Fi pairing mode on the purifier and, in the popped up window, select Blink Quickly:

Reset the device



Press and hold the RESET button for 5 seconds until the indicator blinks (subject to the user manual).

Reset the device



Press and hold the RESET button for 5 seconds until the indicator blinks (subject to the user manual).

Select the status of the indicator light or hear the beep:

Confirm the indicator is blinking rapidly.

Reset Device Step by Step



Blink Slowly



Blink Quickly



10. Wait until the app finds the **PUROXYGEN P500i** purifier:

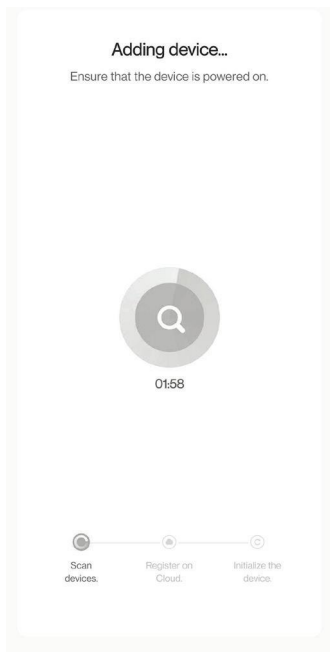

11. Press the + button and then Done:

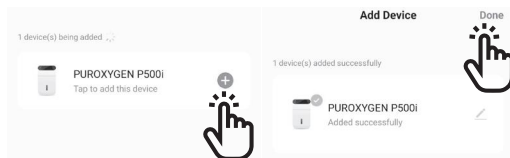

Note: Once connected, you will be able to control the **P500i** purifier using not only Wi-Fi, but also 4G/5G networks.

APP FEATURES

In the app, you will be able to do the following:

1. Power on/off the device:



2. Change the mode between Manual, Auto and Sleep:

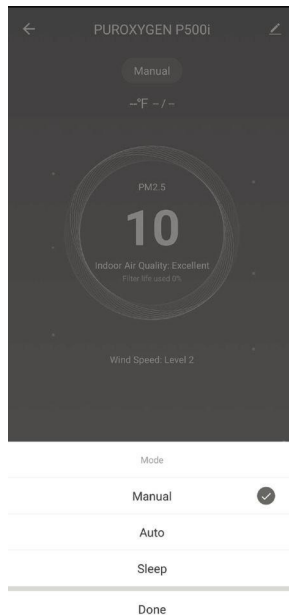

3. Control the fan speed:



Wind Speed Level

Level 1

Level 2



Level 3

Done

4. Control Child Lock and Timer:

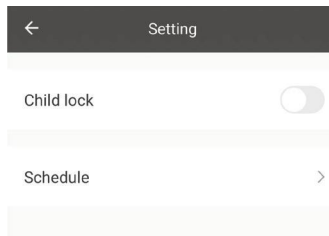

5. Rename the device, link it to the Smart Home Kits (Google, etc.) and so on:

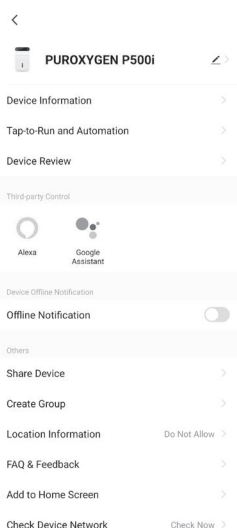

Note: To connect the purifier to several devices you need to install the Smart Life application to the second device and log in into the same account.

MULTI-ACCOUNT CONTROL

If you want to use another Smart Life account on another device, do the following:

1. Install the Smart Life application to the second device.
2. Log in into the account but do not add a new device.
3. On the first device go to **PUROXYGEN P500i**, press the Edit button in the upper right corner. 
4. Select Share Device option and then Add Sharing.
5. Send the invitation link via any suitable messenger.
6. Open the link on the second device using the Smart Life.
7. Accept the invitation on the second device.
8. The purifier will be added to the list.

HOW TO CLEAN

There are several things that should be regularly (**every two months**) cleaned: air inlet/outlet grills, filter + pre-filter and PM2.5 sensor.

To clean the inlet/outlet grills:

1. Turn off the unit and disconnect the power plug from a power source.
2. Wipe the grills with a slightly damp cloth or vacuum them.

To clean the filters:

1. Turn off the unit and disconnect the power plug from a power source.
2. Open the filter cover and remove carefully the combination filter.
3. Unvelcro the blue pre-filter and handwash it by using a soap or alike and let it dry.
4. Vacuum only the front side of the combination filter and put it under the direct sunlight for a couple of hours.
5. Velcro the dried pre-filter back onto the combination filter.
6. Put the filter back into the unit and power it on.

To clean the PM2.5 sensor:

1. Turn off the unit and disconnect the power plug from a power source.
2. Open carefully the sensor cover on the right side of the unit by using a flat screwdriver or alike.
3. Wipe the camera of the sensor and its surface by using a cotton swab.
4. Close the sensor cover.

FILTER REPLACEMENT

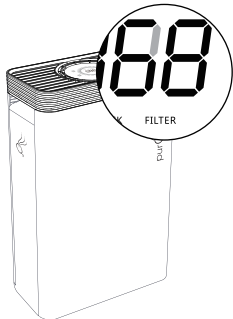

Pic 1.1

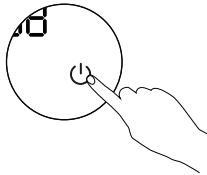

Pic 1.2

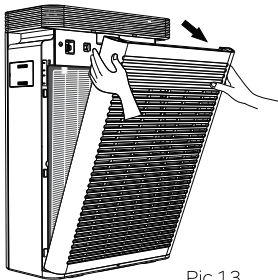

Pic 1.3

When the filter indicator turns red, it is necessary to replace the filter. Pic 1.1

1. Turn off the unit and unplug the power cord. Pic 1.2

2. Open the filter cover. To make it easy, just take the buckle position of the filter cover and pull it out. Pic 1.3

3. Please take out the combination filter and pack the used one into a bag to avoid any second pollution. The combination filter that is out of service cannot be reused even if it is clean. Please consider it as non-burnable waste.

4. Make sure a new filter matches the filter slot of the purifier and then close the cover.

5. Press the **POWER** button to turn it on. Press and hold the **TIMER** button for 3 seconds to reset the filter replacement timer.

TROUBLESHOOTING

If the air purifier does not run smoothly, please check out the following guidelines.

Problem	Possible reasons	Solutions
Machine cannot start	Unplugged power cable	Reconnect a power plug
Odor in the outlet	<ol style="list-style-type: none">1. Too many indoor pollutants such as smoking2. Filter is polluted severely	<ol style="list-style-type: none">1. Air out the place2. Replace the filter
No obvious dust removal effect, no air quality improvement	<ol style="list-style-type: none">1. Filter is not installed into the machine2. Machine is placed in a narrow space or space with nearby obstacles that may sabotage the purification process3. Filter is too dirty	<ol style="list-style-type: none">1. Install the filter correctly2. Place the unit at least a foot away from obstacles3. Replace with a new combination filter
Machine runs with loud noise	<ol style="list-style-type: none">1. Installation is not stable2. Other matters stored in the machine	<ol style="list-style-type: none">1. Check the installation, contact the customer support service2. Clean from other matters

Main buttons do not work	Child Lock mode is turned on	Press and hold the LOCK button for 3 sec to turn off the Child Lock mode
Filter can not be installed	Filter is installed from the opposite side with the pre-filter side placed to inner direction	Adjust the filter to the right direction ("Front" labels outside) and install the filter starting from the bottom part of filter slot
Display always shows 500/air quality indicator is constantly red	PM2.5 air quality sensor is dirty	Clean the PM2.5 sensor using a cotton swab per instructions from the HOW TO CLEAN section

RECYCLING

Please do not discard this product together with other household garbage. Kindly check your local regulations of disposing electrical and electronic products or contact your local waste management company for more information on the purifier disposal.

Also, you may check the recycling services on the following websites:

In the **US**, there are a couple of options:

<https://search.earth911.com>

<https://recyclenation.com/find>

<https://www.cta.tech/Consumer-Resources/Greener-Gadgets>

In **Canada**, please visit the links below for help:

<https://thinkreuse.net>

In the **UK**, please visit the links below for help:

<https://www.recycle-more.co.uk/>

<https://www.recyclenow.com/local-recycling>

SAFETY RULES

- Do not use the device without a filter.
- Please use the device in a room with a temperature higher than 32°F / 0°C and lower than 104°F / 40°C.
- There should be a certain space around the air purifier to allow the wind to flow naturally, thus improving the purification effect.
- Do not put your fingers or objects into the air inlet/outlet.
- Do not place the device close to open fire or hot objects.
- To avoid surface cracking or sensor failure, do not put in places where black smoke might occur (kitchen, etc.)
- Please unplug the power cable from the power socket immediately, if any malfunction happens, such as smoking, bad smell, etc.
- Don't disassemble or modify your purifier for any reason. Doing this may cause the purifier to malfunction or become combustible. The damage to your device can void the manufacturer's warranty.
- To avoid any damage or malfunction of sensor, please clean the device only with a soft cloth.
- To avoid any damage, electric shock or fire disasters, please do not clean the device with ethyl alcohol or organic solvents.
- To avoid electric shock or fire, please power off and unplug the power cord before cleaning or while not using the device.
- Don't put the device's LED lights close to humans' or animals' eyes.
- Device is not intended for use by disabled people, people with mental illness, intellectual disabilities or children.

FCC STATEMENTS

FCC Compliance Statement - Part 15

This device complies with Part 15 of the FCC Rules. Operation is subject to the following two conditions:

1. This device may not cause harmful interference, and
2. This device must accept any interference received, including interference that may cause undesired operation.

Any changes or modifications not expressly approved by the party responsible for compliance could void the user's authority to operate the equipment.

FCC Interference Statement - Part 15

This equipment has been tested and found to comply with the limits for a Class B digital device, pursuant to Part 15 of the FCC Rules. These limits are designed to provide reasonable protection against harmful interference in a residential installation. This equipment generates, uses and can radiate radio frequency energy and, if not installed and used in accordance with the instructions, may cause harmful interference to radio communications. However, there is no guarantee that interference will not occur in a particular installation. If this equipment does cause harmful interference to radio or television reception, which can be determined by turning the equipment off and on, the user is encouraged to try to correct the interference by one of the following measures:

- Reorient or relocate the receiving antenna.

- Increase the separation between the equipment and receiver.
- Consult the dealer or an experienced radio/TV technician for help.

RF Exposure Information

This equipment complies with FCC radiation exposure limits set forth for an uncontrolled environment. In order to avoid the possibility of exceeding the FCC radio frequency exposure limits, human proximity to the antenna shall not be less than 20cm during normal operation.

SPECIFICATIONS

Rated power:	55W
Rated Voltage:	120V, 60Hz
CADR (Particles)*:	123.6 ft ³ /min
Speed modes:	3 speeds
Noise level:	≤ 55dB
Dimensions:	1.67 x 1.08 x 0.56 ft / 510 x 330 x 170 mm
Weight:	9.92 lbs / 4.5 kg

***CADR stands for Clean Air Delivery Rate and is measured in CFM which stands for cubic feet per minute (m³/hour). In general, this value shows exactly how much of the specific particles are removed from the air. In simple words, the CADR rating indicates how fast the air purifier can clean the air within a particular size room.**

PUROXYGEN P500i is not a medical device. It is intended for the household or residential use only and not to diagnose, treat, cure, or prevent any disease or health condition.

THANK YOU!

We truly appreciate that you chose **PUROXYGEN** as your trusted brand of air purifier and sincerely hope you enjoy the great efficiency and seamless usability that the **PUROXYGEN P500i** provides. We love making our customers happy by providing true value with our products. If for any reason you are not completely satisfied with your purchase or have any questions, please contact us via **support@puroxygen.com**. We care about our customers most of all and are always here to serve you.

1 YEAR WARRANTY

Parts and Labor Warranty.
Please visit www.puroxygen.com
to register your product.

Manufactured for Productech Corp
EPA Est. No. 98681-CHN-1

AIR PURIFIER P500i

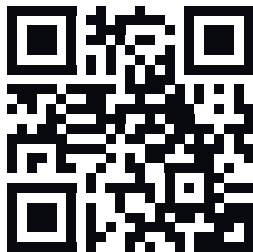

WARNING: This product can expose you to Bisphenol A, which is known to the State of California to cause cancer. For more information, go to www.P65Warnings.ca.gov