



中认信通
CHINA CERTIFICATION ICT CO., LTD (DONGGUAN)



TEST REPORT

Applicant: Shenzhen chengtai electronic and technology co.,LTD

Address: 6th Floor,BuildingC,Qinyu Industrial Zone,SanweiCommunity,Hangcheng Street, Baoan DistrictShenzhenChina

FCC ID: 2A86Y-TG-384MINI

Product Name: TG-384Mini wireless speaker

Standard(s): 47 CFR Part 15, Subpart C(15.247)

ANSI C63.10-2013

KDB 558074 D01 15.247 Meas Guidance v05r02

The above device has been tested and found compliant with the requirement of the relativestandards by China Certification ICT Co., Ltd (Dongguan)

Report Number: CR231278742-00B

Date Of Issue: 2024-01-24

Reviewed By: Calvin.Chen

Title: RF Engineer

Approved By: Sun.Zhong

Title: RF Engineer

Test Laboratory: China Certification ICT Co., Ltd (Dongguan)

No. 113, Pingkang Road, Dalang Town, Dongguan, Guangdong, China

Tel: +86-769-82016888

Test Facility

The Test site used by China Certification ICT Co., Ltd (Dongguan) to collect test data is located on the No. 113, Pingkang Road, Dalang Town, Dongguan, Guangdong, China.

The lab has been recognized as the FCC accredited lab under the KDB 974614 D01 and is listed in the FCC Public Access Link (PAL) database, FCC Registration No. : 442868, the FCC Designation No. : CN1314.

Declarations

China Certification ICT Co., Ltd (Dongguan) is not responsible for the authenticity of any test data provided by the applicant. Data included from the applicant that may affect test results are marked with a triangle symbol “▲”. Customer model name, addresses, names, trademarks etc. are not considered data.

Unless otherwise stated the results shown in this test report refer only to the sample(s) tested.

This report cannot be reproduced except in full, without prior written approval of the Company.

This report is valid only with a valid digital signature. The digital signature may be available only under the Adobe software above version 7.0.

This report may contain data that are not covered by the accreditation scope and shall be marked with an asterisk “★”.

CONTENTS

DOCUMENT REVISION HISTORY	5
1. GENERAL INFORMATION.....	6
1.1 PRODUCT DESCRIPTION FOR EQUIPMENT UNDER TEST (EUT)	6
1.2 DESCRIPTION OF TEST CONFIGURATION.....	7
1.2.1 EUT Operation Condition:.....	7
1.2.2 Support Equipment List and Details	7
1.2.3 Support CableList and Details	7
1.2.4 Block Diagram of Test Setup.....	8
1.3 MEASUREMENT UNCERTAINTY	9
2. SUMMARY OF TEST RESULTS.....	10
3. REQUIREMENTS AND TEST PROCEDURES.....	11
3.1 AC LINE CONDUCTED EMISSIONS.....	11
3.1.1 Applicable Standard.....	11
3.1.2 EUT Setup	12
3.1.3 EMI Test Receiver Setup.....	12
3.1.4 Test Procedure	13
3.1.5 Corrected Amplitude & Margin Calculation	13
3.2 RADIATIONSPURIOUS EMISSIONS.....	14
3.2.1 Applicable Standard.....	14
3.2.2 EUT Setup	14
3.2.3 EMI Test Receiver & Spectrum Analyzer Setup	15
3.2.4 Test Procedure	16
3.2.5 Corrected Amplitude & Margin Calculation	16
3.3 MINIMUM 6 dB BANDWIDTH.....	17
3.3.1 Applicable Standard.....	17
3.3.2 EUT Setup	17
3.3.3 Test Procedure	17
3.4 MAXIMUMCONDUCTED OUTPUT POWER	18
3.4.1 Applicable Standard.....	18
3.4.2 EUT Setup	18
3.4.3 Test Procedure	18
3.5 MAXIMUM POWER SPECTRAL DENSITY.....	19
3.5.1 Applicable Standard.....	19
3.5.2 EUT Setup	19
3.5.3 Test Procedure	19
3.6 100 KHZ BANDWIDTH OF FREQUENCY BAND EDGE	20
3.6.1 Applicable Standard.....	20
3.6.2 EUT Setup	20
3.6.3 Test Procedure	20
3.7 DUTY CYCLE.....	21
3.7.1 EUT Setup	21
3.7.2 Test Procedure	21
3.8 ANTENNA REQUIREMENT	22
3.8.1 Applicable Standard.....	22
3.8.2 Judgment.....	22

4. TESTDATA AND RESULTS..... 23

4.1 AC LINE CONDUCTED EMISSIONS..... 23

4.2 RADIATION SPURIOUS EMISSIONS..... 26

4.3 6DB EMISSION BANDWIDTH..... 38

4.4 MAXIMUM CONDUCTED OUTPUT POWER 42

4.5 100 KHZ BANDWIDTH OF FREQUENCY BAND EDGE 46

4.6 POWER SPECTRAL DENSITY 50

4.7 DUTY CYCLE..... 54

5. RF EXPOSURE EVALUATION 58

5.1 APPLICABLE STANDARD..... 58

5.2 MEASUREMENT RESULT 58

6. EUT PHOTOGRAPHS 59

7. TEST SETUPPHOTOGRAPHS..... 60

DOCUMENT REVISION HISTORY

Revision Number	Report Number	Description of Revision	Date of Revision
1.0	CR231278742-00B	Original Report	2024-01-24

1. GENERAL INFORMATION

1.1 Product Description for Equipment under Test (EUT)

EUT Name:	TG-384Mini wireless speaker
EUT Model:	TG-384Mini
Multiple Model:	TG-116C, TG-129C, TG-166, TG-179, TG-182, TG-187, TG-192, TG-227, TG-271, TG-288, TG-289, TG-294, TG-322, TG-368, TG-373, TG-376, TG-384, TG-392, TG-394, TG-395, TG-397, TG-396, TG-411, TG-415, TG-416, TG-421, TG-369 , TG-418, TG-419, TG-423, TG506, TG534, TG537, TG619, TG643, TG651, TG652, TG653, TG654, TG655, TG656, TG657, TG658, TG659, TG661, TG662, TG663, TG664, TG665, TG668, TG526
Operation Frequency:	2402-2480 MHz
Maximum Peak Output Power (Conducted):	-3.07dBm
Modulation Type:	GFSK
Rated Input Voltage:	DC 5V Charging from adapter and DC 3.7V from battery
Serial Number:	2FV7-2(For AC Line conducted emissions and Radiated Spurious Emission Test) 2FV7-1(For RF Conduced Test)
EUT Received Date:	2024/1/3
EUT Received Status:	Good

Note: The multiple models are electrically identical with the test model. Please refer to the declaration letter for more detail, which was provided by manufacturer.

Operation Frequency Detail: For BLE:

Channel	Frequency (MHz)	Channel	Frequency (MHz)
0	2402	20	2442
1	2404
...
...
..	...	38	2478
19	2440	39	2480

Per section 15.31(m), the below frequencies were performed the test as below:

Test Channel	Frequency (MHz)
Lowest	2402
Middle	2440
Highest	2480

AntennaInformation Detail▲:

Antenna Type	input impedance (Ohm)	Frequency Range (GHz)	Antenna Gain (dBi)
PCB	50	2.4~2.5	1.9

The Method of §15.203 Compliance:

- Antenna was permanently attached to the unit.
- Antenna use a unique type of connector to attach to the EUT.
- Unit was professionally installed, and installer shall be responsible for verifying that the correct antenna is employed with the unit.

Accessory Information:

Accessory Description	Manufacturer	Model
\	\	\

1.2 Description of Test Configuration**1.2.1 EUT Operation Condition:**

EUT Operation Mode:	The system was configured for testing in Engineering Mode, which was provided by the manufacturer.
Equipment Modifications:	No
EUT Exercise Software:	FCC_assist_1.0.2.2.exe

The software was provided by manufacturer. The maximum power was configured as below, that was provided by the manufacturer ▲ :

Test Modes	Power Level Setting		
	Lowest Channel	Middle Channel	Highest Channel
1M bps	Default	Default	Default
2M bps	Default	Default	Default

1.2.2 Support Equipment List and Details

Manufacturer	Description	Model	Serial Number
JianAohai	Adapter	A8-050200U-US3	AD220930002
SanDisk	TF Card	32 GB	521005904698
HP	USB Disk	HPFD206W-32	PAA6918477

1.2.3 Support CableList and Details

Cable Description	Shielding Type	Ferrite Core	Length (m)	From Port	To
USB-C Cable	No	No	0.8	Adapter	EUT

1.2.4 Block Diagram of Test Setup

AC line conducted emissions:

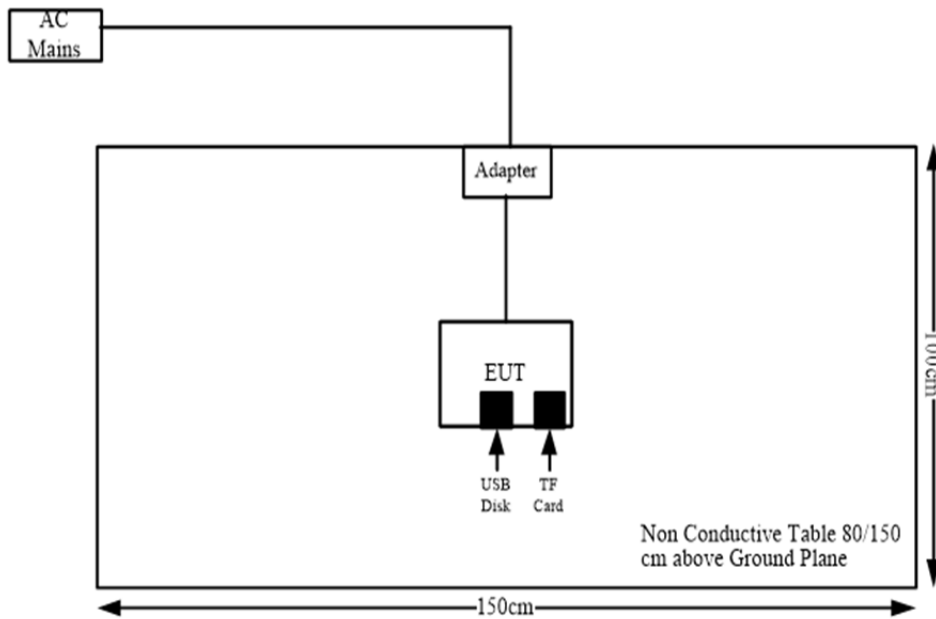
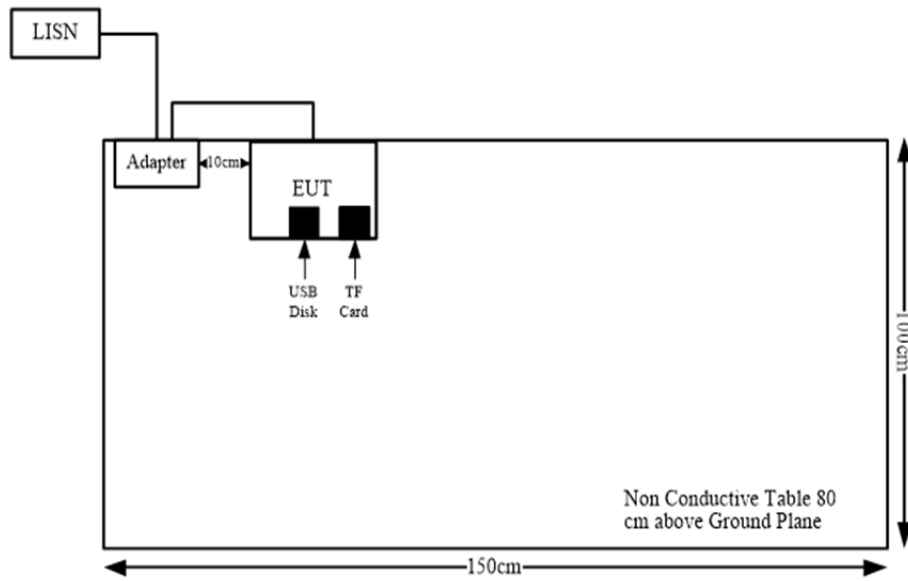

1.3 Measurement Uncertainty

Otherwise required by the applicant or Product Regulations, Decision Rule in this report did not consider the uncertainty. The extended uncertainty given in this report is obtained by combining the standard uncertainty times the coverage factor K with the 95% confidence interval.

Parameter	Measurement Uncertainty
Occupied Channel Bandwidth	±5 %
RF output power, conducted	±0.61dB
Power Spectral Density, conducted	±0.61 dB
Unwanted Emissions, radiated	9k~30MHz: 4.12dB, 30M~200MHz: 4.15 dB, 200M~1GHz: 5.61 dB, 1G~6GHz: 5.14 dB, 6G~18GHz: 5.93 dB, 18G~26.5G: 5.47 dB, 26.5G~40G: 5.63 dB
Unwanted Emissions, conducted	±1.26 dB
Temperature	±1 °C
Humidity	±5%
DC and low frequency voltages	±0.4%
Duty Cycle	1%
AC Power Lines Conducted Emission	2.8 dB (150 kHz to 30 MHz)

2. SUMMARY OF TEST RESULTS

FCC Rules	Description of Test	Result
FCC §15.203	Antenna Requirement	PASS
FCC §15.207(a)	AC Line Conducted Emissions	PASS
FCC §15.205,§15.209,§15.247(d)	Radiated Spurious Emission	PASS
FCC §15.207(a)(2)	6dB Emission Bandwidth	PASS
FCC §15.247(b)(1)	Maximum Conducted Output Power	PASS
FCC §15.247(d)	100 kHz Bandwidth of Frequency Band Edge	PASS
FCC §15.247(e)	Power Spectral Density	PASS
C63.10 §11.6	Duty Cycle	PASS
FCC §1.1310&§2.1093&§15.247 (i)	RF Exposure	PASS

3. REQUIREMENTS AND TEST PROCEDURES

3.1 AC Line Conducted Emissions

3.1.1 Applicable Standard

FCC§15.207(a).

(a) Except as shown in paragraphs (b) and (c) of this section, for an intentional radiator that is designed to be connected to the public utility (AC) power line, the radio frequency voltage that is conducted back onto the AC power line on any frequency or frequencies, within the band 150 kHz to 30 MHz, shall not exceed the limits in the following table, as measured using a 50 μ H/50 ohms line impedance stabilization network (LISN). Compliance with the provisions of this paragraph shall be based on the measurement of the radio frequency voltage between each power line and ground at the power terminal. The lower limit applies at the boundary between the frequency ranges.

Frequency of emission (MHz)	Conducted limit (dB μ V)	
	Quasi-peak	Average
0.15-0.5	66 to 56*	56 to 46*
0.5-5	56	46
5-30	60	50

*Decreases with the logarithm of the frequency.

(b) The limit shown in paragraph (a) of this section shall not apply to carrier current systems operating as intentional radiators on frequencies below 30 MHz. In lieu thereof, these carrier current systems shall be subject to the following standards:

(1) For carrier current system containing their fundamental emission within the frequency band 535-1705 kHz and intended to be received using a standard AM broadcast receiver: no limit on conducted emissions.

(2) For all other carrier current systems: 1000 μ V within the frequency band 535-1705 kHz, as measured using a 50 μ H/50 ohms LISN.

(3) Carrier current systems operating below 30 MHz are also subject to the radiated emission limits in §15.205, §15.209, §15.221, §15.223, or §15.227, as appropriate.

(c) Measurements to demonstrate compliance with the conducted limits are not required for devices which only employ battery power for operation and which do not operate from the AC power lines or contain provisions for operation while connected to the AC power lines. Devices that include, or make provisions for, the use of battery chargers which permit operating while charging, AC adapters or battery eliminators or that connect to the AC power lines indirectly, obtaining their power through another device which is connected to the AC power lines, shall be tested to demonstrate compliance with the conducted limits.

3.1.2 EUT Setup

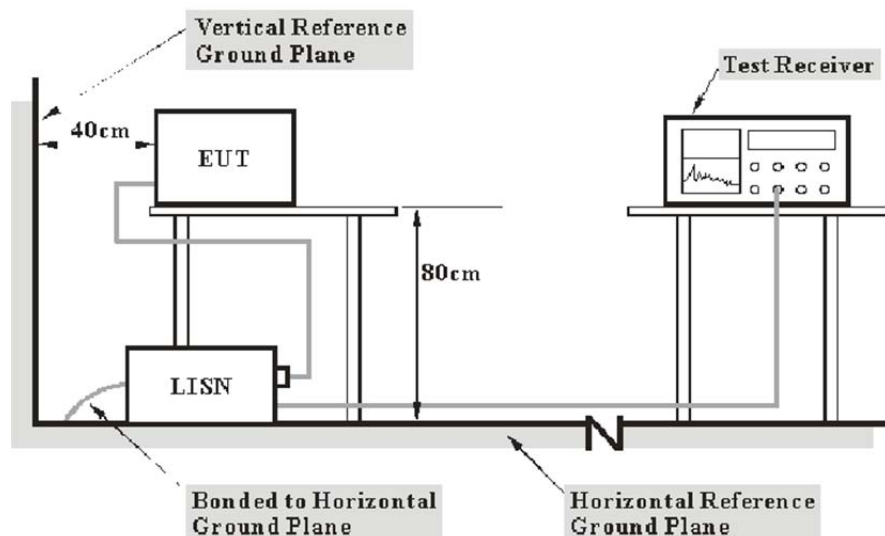

- Note: 1. Support units were connected to second LISN.
 2. Both of LISNs (AMN) 80 cm from EUT and at the least 80 cm from other units and other metal planes support units.

The setup of EUT is according with per ANSI C63.10-2013 measurement procedure. The specification used was with the FCC Part 15.207limits.

The spacing between the peripherals was 10cm.

3.1.3 EMI Test Receiver Setup

The EMI test receiver was set to investigate the spectrum from 150 kHz to 30MHz.

During the conducted emission test, the EMI test receiver was set with the following configurations:

Frequency Range	IF B/W
150 kHz – 30 MHz	9 kHz

3.1.4 Test Procedure

The frequency and amplitude of the six highest ac power-line conducted emissions relative to the limit, measured over all the current-carrying conductors of the EUT power cords, and the operating frequency or frequency to which the EUT is tuned (if appropriate), should be reported, unless such emissions are more than 20 dB below the limit. AC power-line conducted emissions measurements are to be separately carried out only on each of the phase (“hot”) line(s) and (if used) on the neutral line(s), but not on the ground [protective earth] line(s). If less than six emission frequencies are within 20 dB of the limit, then the noise level of the measuring instrument at representative frequencies should be reported. The specific conductor of the power-line cord for each of the reported emissions should be identified. Measure the six highest emissions with respect to the limit on each current-carrying conductor of each power cord associated with the EUT (but not the power cords of associated or peripheral equipment that are part of the test configuration). Then, report the six highest emissions with respect to the limit from among all the measurements identifying the frequency and specific current-carrying conductor identified with the emission. The six highest emissions should be reported for each of the current-carrying conductors, or the six highest emissions may be reported over all the current-carrying conductors.

3.1.5 Corrected Amplitude & Margin Calculation

The basic equation is as follows:

Result = Reading + Factor

Factor = attenuation caused by cable loss + voltage division factor of AMN

The “**Margin**” column of the following data tables indicates the degree of compliance within the applicable limit. The equation for margin calculation is as follows:

Margin = Limit – Result

3.2 Radiation Spurious Emissions

3.2.1 Applicable Standard

FCC §15.247 (d);

In any 100 kHz bandwidth outside the frequency band in which the spread spectrum or digitally modulated intentional radiator is operating, the radio frequency power that is produced by the intentional radiator shall be at least 20 dB below that in the 100 kHz bandwidth within the band that contains the highest level of the desired power, based on either an RF conducted or a radiated measurement, provided the transmitter demonstrates compliance with the peak conducted power limits. If the transmitter complies with the conducted power limits based on the use of RMS averaging over a time interval, as permitted under paragraph (b)(3) of this section, the attenuation required under this paragraph shall be 30 dB instead of 20 dB. Attenuation below the general limits specified in §15.209(a) is not required. In addition, radiated emissions which fall in the restricted bands, as defined in §15.205(a), must also comply with the radiated emission limits specified in §15.209(a) (see §15.205(c)).

3.2.2 EUT Setup

9kHz - 30MHz:

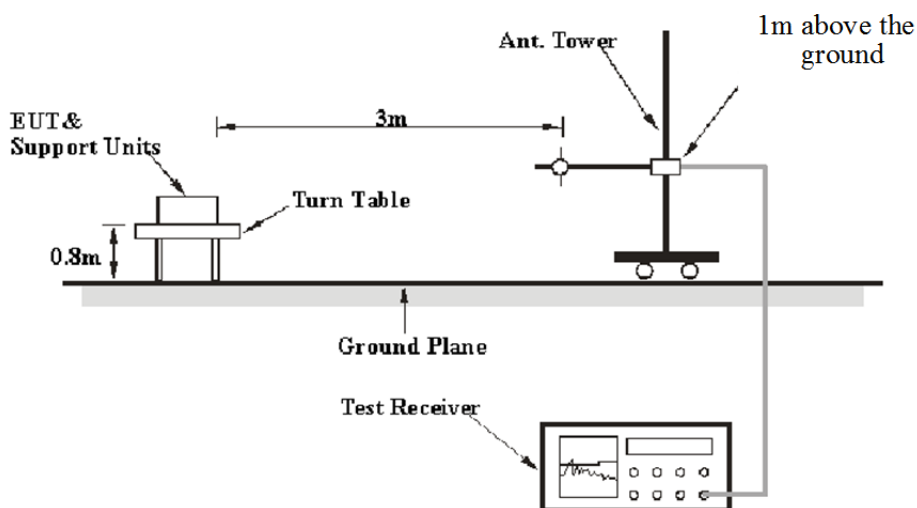

30MHz - 1GHz:

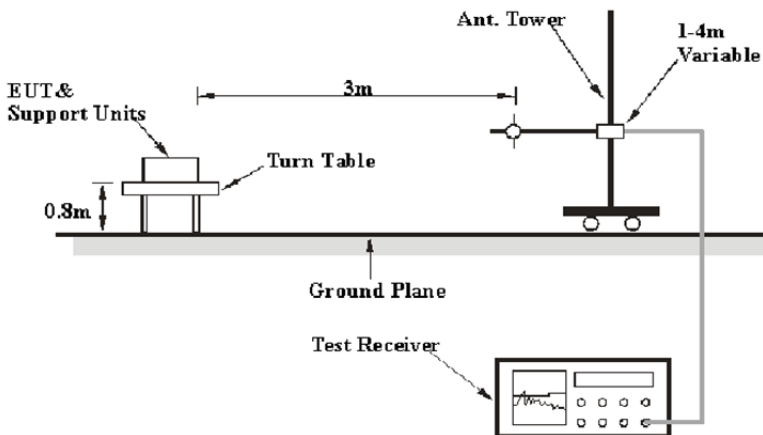

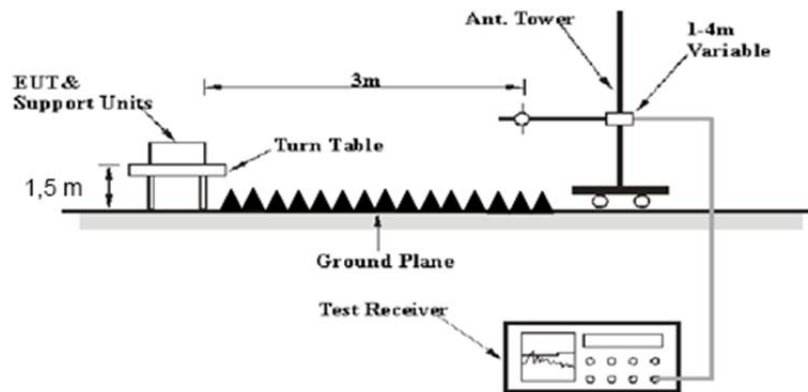
Above 1GHz:

The radiated emissions were performed in the 3 meters distance, using the setup accordance with the ANSI C63.10-2013. The specification used was the FCC 15.209, and FCC 15.247 limits.

The external I/O cables were draped along the test table and formed a bundle 30 to 40cm long in the middle.

The spacing between the peripherals was 10cm.

3.2.3 EMI Test Receiver & Spectrum Analyzer Setup

The system was investigated from 9kHz to 25 GHz.

During the radiated emission test, the EMI test receiver & Spectrum Analyzer Setup were set with the following configurations:

9kHz-1000MHz:

Frequency Range	RBW	Video B/W	IF B/W	Measurement
9 kHz – 150 kHz	300 Hz	1 kHz	/	PK
	/	/	200 Hz	QP/AV
150 kHz – 30 MHz	10 kHz	30 kHz	/	PK
	/	/	9 kHz	QP/AV
30 MHz – 1000 MHz	100 kHz	300 kHz	/	PK
	/	/	120 kHz	QP

1GHz- 25GHz:

Measurement	Duty cycle	RBW	Video B/W
PK	Any	1MHz	3 MHz
Ave.	>98%	1MHz	10 Hz
	<98%	1MHz	$\geq 1/T$

Note: T is minimum transmission duration

If the maximized peak measured value is under the QP/Average limit by more than 6dB, then it is unnecessary to perform an QP/Average measurement.

The spurious emissions which below the limit more than 20dB was not be recorded.

3.2.4 Test Procedure

Maximizing procedure was performed on the highest emissions to ensure that the EUT complied with all installation combinations.

Data was recorded in Quasi-peak detection mode for frequency range of 9 kHz-1 GHz except 9–90 kHz, 110–490 kHz, employing an average detector, peak and Average detection modes for frequencies above 1 GHz.

All emissions under the average limit and under the noise floor have not recorded in the report.

3.2.5 Corrected Amplitude & Margin Calculation

The basic equation is as follows:

Result = Reading + Factor

Factor= Antenna Factor + Cable Loss- Amplifier Gain

The “**Margin**” column of the following data tables indicates the degree of compliance within the applicable limit. The equation for margin calculation is as follows:

Margin = Limit – Result

3.3 Minimum 6 dB Bandwidth

3.3.1 Applicable Standard

FCC §15.247 (a)(2)

Systems using digital modulation techniques may operate in the 902-928 MHz, 2400-2483.5 MHz, and 5725-5850 MHz bands. The minimum 6 dB bandwidth shall be at least 500 kHz.

3.3.2 EUT Setup

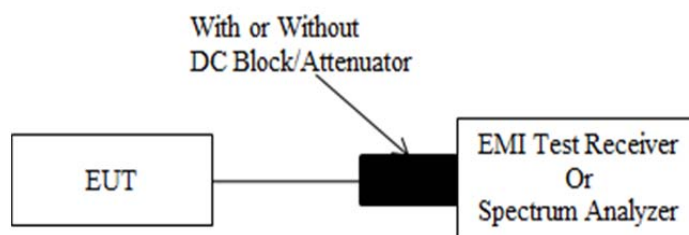

3.3.3 Test Procedure

According to ANSI C63.10-2013 Section 11.8

- a) Set RBW = 100 kHz.
- b) Set the video bandwidth (VBW) $\geq 3 \times$ RBW.
- c) Detector = Peak.
- d) Trace mode = max hold.
- e) Sweep = auto couple.
- f) Allow the trace to stabilize.
- g) Measure the maximum width of the emission that is constrained by the frequencies associated with the two outermost amplitude points (upper and lower frequencies) that are attenuated by 6 dB relative to the maximum level measured in the fundamental emission.

3.4 Maximum Conducted Output Power

3.4.1 Applicable Standard

FCC §15.247 (b)(3)

For systems using digital modulation in the 902-928 MHz, 2400-2483.5 MHz, and 5725-5850 MHz bands: 1 Watt. As an alternative to a peak power measurement, compliance with the one Watt limit can be based on a measurement of the maximum conducted output power. Maximum Conducted Output Power is defined as the total transmit power delivered to all antennas and antenna elements averaged across all symbols in the signaling alphabet when the transmitter is operating at its maximum power control level. Power must be summed across all antennas and antenna elements. The average must not include any time intervals during which the transmitter is off or is transmitting at a reduced power level. If multiple modes of operation are possible (e.g., alternative modulation methods), the maximum conducted output power is the highest total transmit power occurring in any mode.

3.4.2 EUT Setup

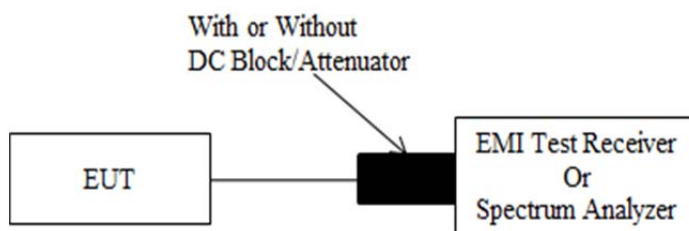

3.4.3 Test Procedure

According to ANSI C63.10-2013 Section 11.9.1.1

The following procedure shall be used when an instrument with a resolution bandwidth that is greater than the DTS bandwidth is available to perform the measurement:

- a) Set the RBW \geq DTS bandwidth.
- b) Set VBW $\geq [3 \times \text{RBW}]$.
- c) Set span $\geq [3 \times \text{RBW}]$.
- d) Sweep time = auto couple.
- e) Detector = peak.
- f) Trace mode = max hold.
- g) Allow trace to fully stabilize.
- h) Use peak marker function to determine the peak amplitude level.

3.5 Maximum power spectral density

3.5.1 Applicable Standard

FCC §15.247 (e)

For digitally modulated systems, the power spectral density conducted from the intentional radiator to the antenna shall not be greater than 8 dBm in any 3 kHz band during any time interval of continuous transmission. This power spectral density shall be determined in accordance with the provisions of paragraph (b) of this section. The same method of determining the conducted output power shall be used to determine the power spectral density.

3.5.2 EUT Setup

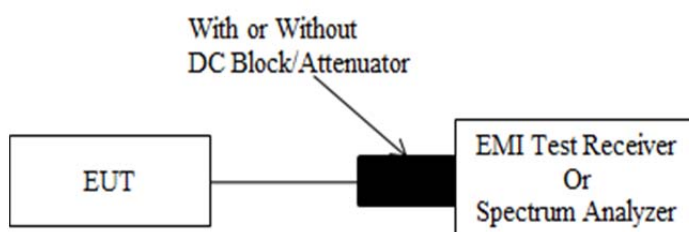

3.5.3 Test Procedure

According to ANSI C63.10-2013 Section 11.10.2

- a) Set analyzer center frequency to DTS channel center frequency.
- b) Set the span to 1.5 times the DTS bandwidth.
- c) Set the RBW to $3 \text{ kHz} \leq \text{RBW} \leq 100 \text{ kHz}$.
- d) Set the VBW $\geq [3 \times \text{RBW}]$.
- e) Detector = peak.
- f) Sweep time = auto couple.
- g) Trace mode = max hold.
- h) Allow trace to fully stabilize.
- i) Use the peak marker function to determine the maximum amplitude level within the RBW.
- j) If measured value exceeds requirement, then reduce RBW (but no less than 3 kHz) and repeat.

3.6 100 kHz Bandwidth of Frequency Band Edge

3.6.1 Applicable Standard

FCC §15.247 (d);

In any 100 kHz bandwidth outside the frequency band in which the spread spectrum or digitally modulated intentional radiator is operating, the radio frequency power that is produced by the intentional radiator shall be at least 20 dB below that in the 100 kHz bandwidth within the band that contains the highest level of the desired power, based on either an RF conducted or a radiated measurement, provided the transmitter demonstrates compliance with the peak conducted power limits. If the transmitter complies with the conducted power limits based on the use of RMS averaging over a time interval, as permitted under paragraph (b)(3) of this section, the attenuation required under this paragraph shall be 30 dB instead of 20 dB. Attenuation below the general limits specified in §15.209(a) is not required. In addition, radiated emissions which fall in the restricted bands, as defined in §15.205(a), must also comply with the radiated emission limits specified in §15.209(a) (see §15.205(c)).

3.6.2 EUT Setup

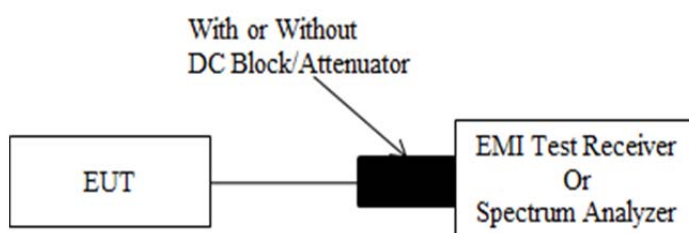

3.6.3 Test Procedure

According to ANSI C63.10-2013 Section 11.11

- a) Set the center frequency and span to encompass frequency range to be measured.
- b) Set the RBW = 100 kHz.
- c) Set the VBW $\geq [3 \times \text{RBW}]$.
- d) Detector = peak.
- e) Sweep time = auto couple.
- f) Trace mode = max hold.
- g) Allow trace to fully stabilize.
- h) Use the peak marker function to determine the maximum amplitude level.

Ensure that the amplitude of all unwanted emissions outside of the authorized frequency band (excluding restricted frequency bands) is attenuated by at least the minimum requirements specified in 11.11. Report the three highest emissions relative to the limit.

3.7 Duty Cycle

3.7.1 EUT Setup

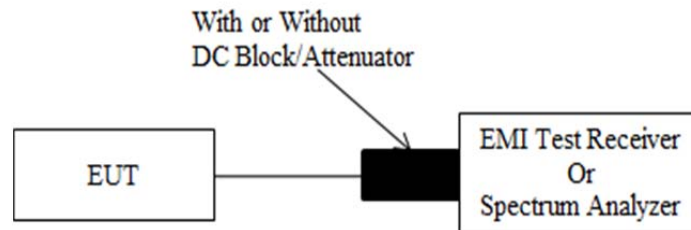

3.7.2 Test Procedure

According to ANSI C63.10-2013 Section 11.6

The zero-span mode on a spectrum analyzer or EMI receiver if the response time and spacing between bins on the sweep are sufficient to permit accurate measurements of the ON and OFF times of the transmitted signal:

- 1) Set the center frequency of the instrument to the center frequency of the transmission.
- 2) Set $RBW \geq OBW$ if possible; otherwise, set RBW to the largest available value.
- 3) Set $VBW \geq RBW$. Set detector = peak or average.
- 4) The zero-span measurement method shall not be used unless both RBW and VBW are $> 50/T$ and the number of sweep points across duration T exceeds 100. (For example, if VBW and/or RBW are limited to 3 MHz, then the zero-span method of measuring the duty cycle shall not be used if $T \leq 16.7 \mu s$.)

3.8 Antenna Requirement

3.8.1 Applicable Standard

FCC §15.203

An intentional radiator shall be designed to ensure that no antenna other than that furnished by the responsible party shall be used with the device. The use of a permanently attached antenna or of an antenna that uses a unique coupling to the intentional radiator shall be considered sufficient to comply with the provisions of this section. The manufacturer may design the unit so that a broken antenna can be replaced by the user, but the use of a standard antenna jack or electrical connector is prohibited. This requirement does not apply to carrier current devices or to devices operated under the provisions of §§15.211, 15.213, 15.217, 15.219, 15.221, or §15.236. Further, this requirement does not apply to intentional radiators that must be professionally installed, such as perimeter protection systems and some field disturbance sensors, or to other intentional radiators which, in accordance with §15.31(d), must be measured at the installation site. However, the installer shall be responsible for ensuring that the proper antenna is employed so that the limits in this part are not exceeded.

3.8.2 Judgment

Compliant. Please refer to the Antenna Information detail in Section 1.

4. TESTDATA AND RESULTS

4.1 AC Line Conducted Emissions

Serial Number:	2FV7-2	Test Date:	2024/1/10
Test Site:	CE	Test Mode:	Transmitting (maximum output power, BLE 1M Low Channel)
Tester:	David Huang	Test Result:	Pass

Environmental Conditions:

Temperature: (°C)	26	Relative Humidity: (%)	47	ATM Pressure: (kPa)	101.1
----------------------	----	---------------------------	----	------------------------	-------

Test Equipment List and Details:

Manufacturer	Description	Model	Serial Number	Calibration Date	Calibration Due Date
R&S	LISN	ENV216	101134	2023/3/31	2024/3/30
R&S	EMI Test Receiver	ESR3	102726	2023/3/31	2024/3/30
MICRO-COAX	Coaxial Cable	UTIFLEX	C-0200-01	2023/8/6	2024/8/5
Audix	Test Software	E3	190306 (V9)	N/A	N/A

* Statement of Traceability: China Certification ICT Co., Ltd (Dongguan) attests that all calibrations have been performed, traceable to National Primary Standards and International System of Units (SI).

Project No.: CR231278742-RF
 Tester: David Huang
 Port: Line
 Note: Transmitting(BLE)

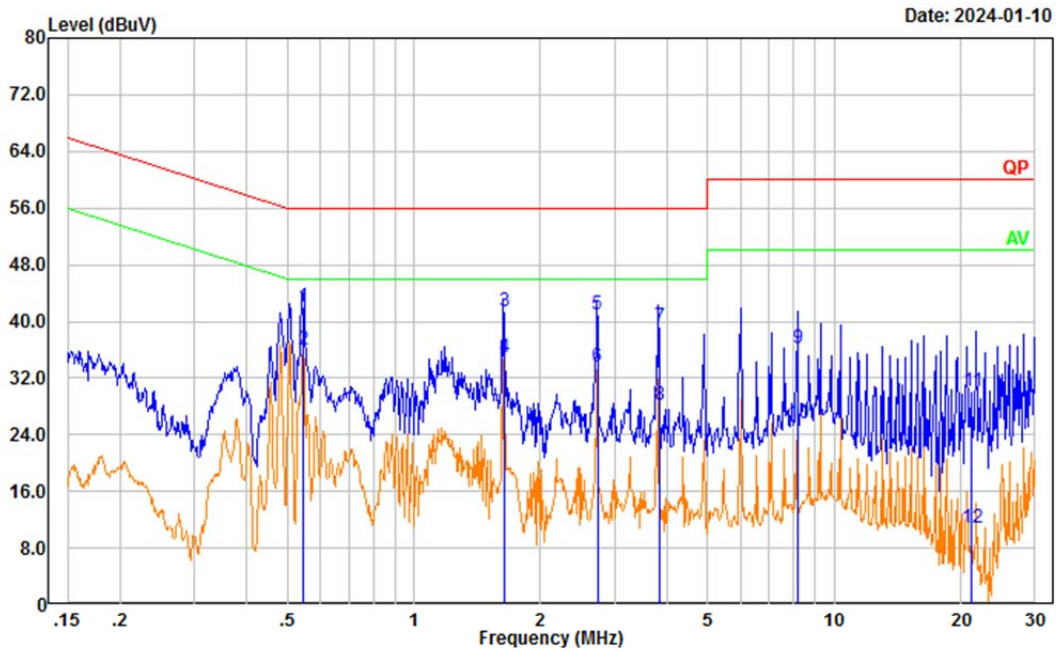

Date: 2024-01-10

No.	Frequency (MHz)	Reading (dBμV)	Factor (dB)	Result (dBμV)	Limit (dBμV)	Margin (dB)	Detector
1	0.546	32.40	9.61	42.01	56.00	13.99	QP
2	0.546	26.28	9.61	35.89	46.00	10.11	Average
3	1.636	31.82	9.63	41.45	56.00	14.55	QP
4	1.636	25.21	9.63	34.84	46.00	11.16	Average
5	2.731	31.32	9.64	40.96	56.00	15.04	QP
6	2.731	24.00	9.64	33.64	46.00	12.36	Average
7	3.828	29.53	9.65	39.18	56.00	16.82	QP
8	3.828	18.46	9.65	28.11	46.00	17.89	Average
9	8.201	26.57	9.67	36.24	60.00	23.76	QP
10	8.201	15.83	9.67	25.50	50.00	24.50	Average
11	21.255	20.36	9.80	30.16	60.00	29.84	QP
12	21.255	1.06	9.80	10.86	50.00	39.14	Average

Project No.: CR231278742-RF
 Tester: David Huang
 Port: neutral
 Note: Transmitting(BLE)

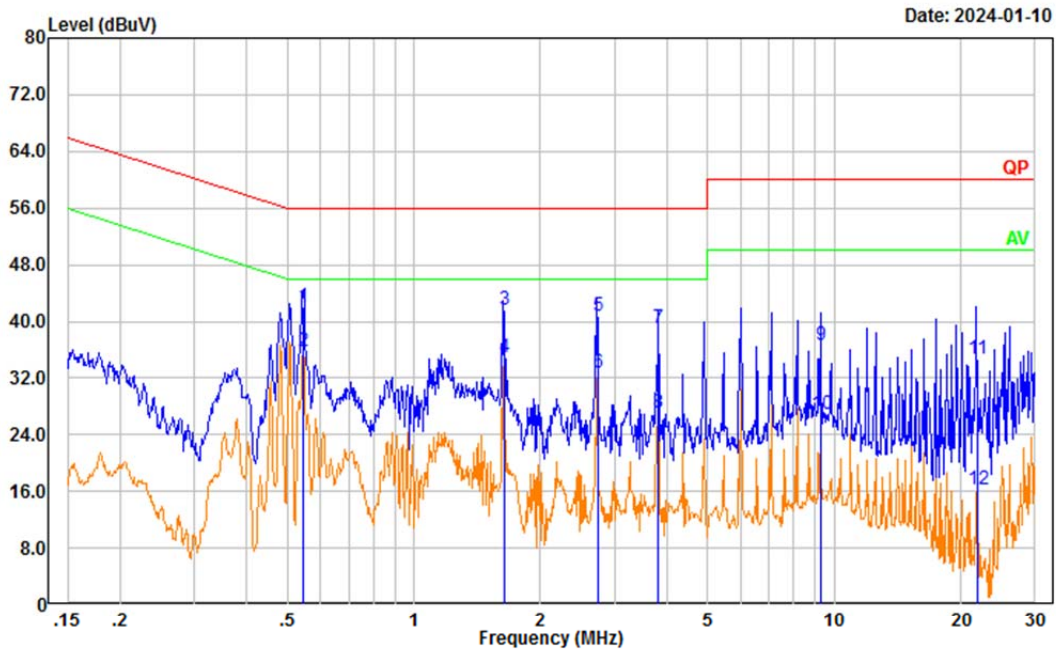

Date: 2024-01-10

No.	Frequency (MHz)	Reading (dBμV)	Factor (dB)	Result (dBμV)	Limit (dBμV)	Margin (dB)	Detector
1	0.546	32.47	9.61	42.08	56.00	13.92	QP
2	0.546	26.25	9.61	35.86	46.00	10.14	Average
3	1.639	31.94	9.63	41.57	56.00	14.43	QP
4	1.639	25.38	9.63	35.01	46.00	10.99	Average
5	2.733	31.18	9.64	40.82	56.00	15.18	QP
6	2.733	23.18	9.64	32.82	46.00	13.18	Average
7	3.816	29.33	9.65	38.98	56.00	17.02	QP
8	3.816	17.51	9.65	27.16	46.00	18.84	Average
9	9.284	27.05	9.67	36.72	60.00	23.28	QP
10	9.284	17.27	9.67	26.94	50.00	23.06	Average
11	21.846	25.03	9.73	34.76	60.00	25.24	QP
12	21.846	6.50	9.73	16.23	50.00	33.77	Average

4.2 Radiation Spurious Emissions

1) 30MHz-1GHz

Serial Number:	2FV7-2	Test Date:	2024/1/7
Test Site:	966-2	Test Mode:	Transmitting (maximum output power, BLE 1M Low Channel)
Tester:	Carl Xue	Test Result:	Pass

Environmental Conditions:

Temperature: (°C)	25.2	Relative Humidity: (%)	46	ATM Pressure: (kPa)	102.2
-------------------	------	------------------------	----	---------------------	-------

Test Equipment List and Details:

Manufacturer	Description	Model	Serial Number	Calibration Date	Calibration Due Date
Sunol Sciences	Antenna	JB6	A082520-5	2023/12/1	2026/11/30
BACL	Loop Antenna	1313-1P	3092721	2023/10/20	2026/10/19
R&S	EMI Test Receiver	ESR3	102724	2023/3/31	2024/3/30
TIMES MICROWAVE	Coaxial Cable	LMR-600-UltraFlex	C-0470-02	2023/7/16	2024/7/15
TIMES MICROWAVE	Coaxial Cable	LMR-600-UltraFlex	C-0780-01	2023/7/16	2024/7/15
Sonoma	Amplifier	310N	186165	2023/7/16	2024/7/15
Audix	Test Software	E3	201021 (V9)	N/A	N/A

* Statement of Traceability: China Certification ICT Co., Ltd (Dongguan) attests that all calibrations have been performed, traceable to National Primary Standards and International System of Units (SI).

Test Data:

After pre-scan in the X, Y and Z axes of orientation, the worst case is refer to plots.
For 9kHz-30MHz, The amplitude of spurious emissions attenuated more than 20 dB below the limit was not recorded.

Project No.: CR231278742-RF
 Tester: Carl Xue
 Polarization: horizontal
 Note: Transmitting(BLE 1M Low Channel)

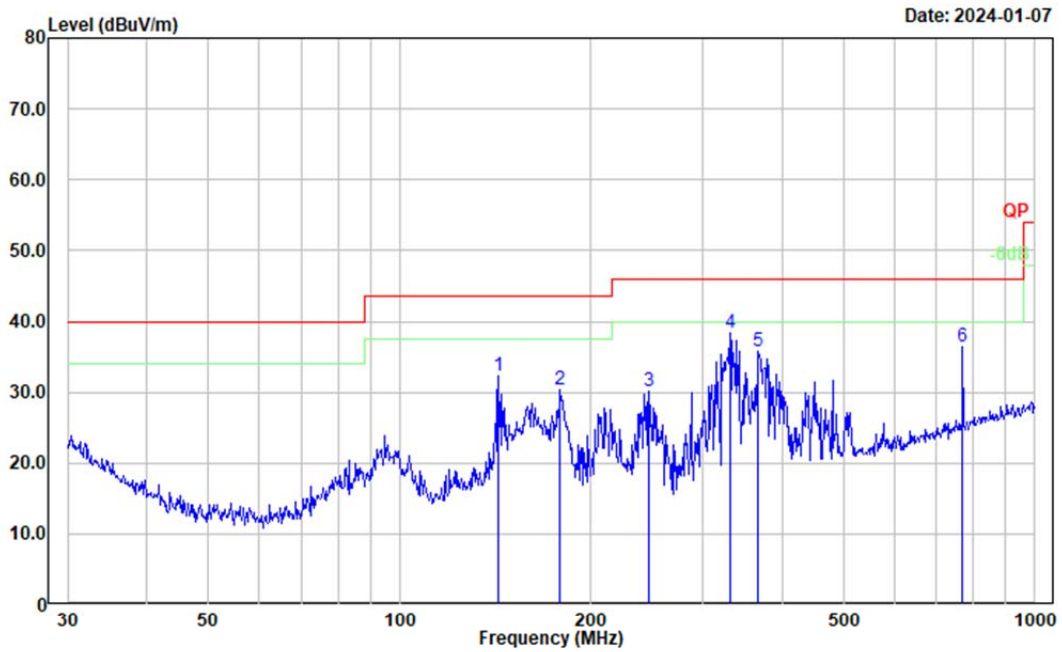

No.	Frequency (MHz)	Reading (dB μ V)	Factor (dB/m)	Result (dB μ V/m)	Limit (dB μ V/m)	Margin (dB)	Detector
1	143.326	44.40	-12.04	32.36	43.50	11.14	Peak
2	178.758	43.70	-13.37	30.33	43.50	13.17	Peak
3	246.815	43.14	-12.92	30.22	46.00	15.78	Peak
4	331.355	48.26	-9.80	38.46	46.00	7.54	Peak
5	366.823	44.93	-9.19	35.74	46.00	10.26	Peak
6	768.748	38.39	-2.07	36.32	46.00	9.68	Peak

Project No.: CR231278742-RF
 Tester: Carl Xue
 Polarization: vertical
 Note: Transmitting(BLE 1M Low Channel)

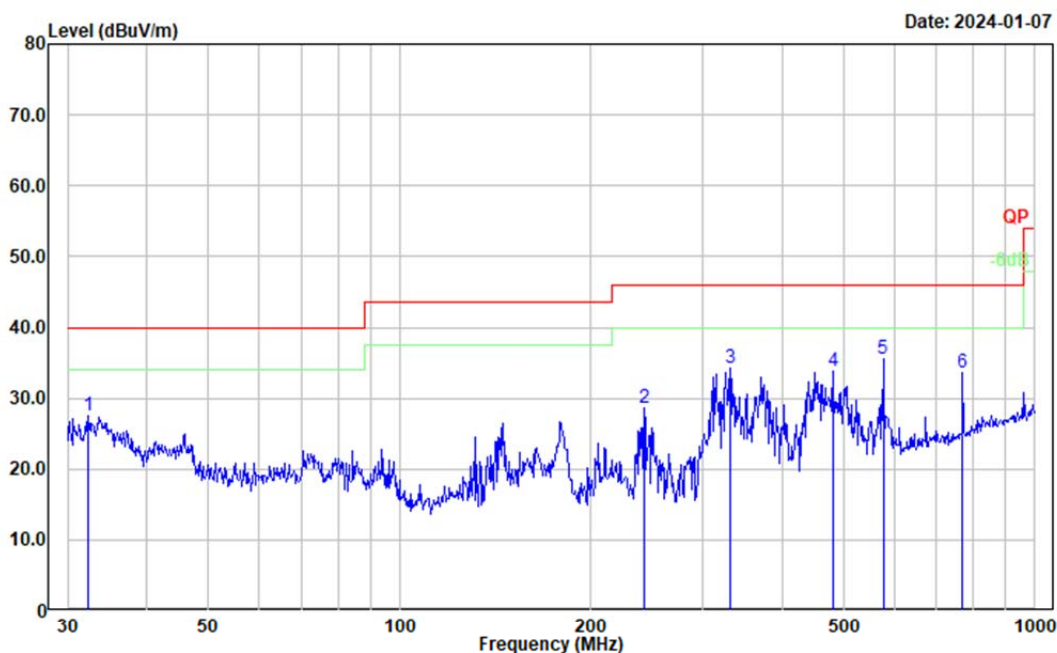

No.	Frequency (MHz)	Reading (dBμV)	Factor (dB/m)	Result (dBμV/m)	Limit (dBμV/m)	Margin (dB)	Detector
1	32.406	33.19	-5.58	27.61	40.00	12.39	Peak
2	242.525	41.38	-12.83	28.55	46.00	17.45	Peak
3	331.355	44.07	-9.80	34.27	46.00	11.73	Peak
4	480.528	39.91	-6.16	33.75	46.00	12.25	Peak
5	576.644	40.06	-4.58	35.48	46.00	10.52	Peak
6	768.748	35.72	-2.07	33.65	46.00	12.35	Peak

2) 1-25GHz:

Serial Number:	2FV7-2	Test Date:	2024/1/7
Test Site:	966-1	Test Mode:	Transmitting
Tester:	Tao Zhu	Test Result:	Pass

Environmental Conditions:

Temperature: (°C)	25	Relative Humidity: (%)	57	ATM Pressure: (kPa)	102.2
----------------------	----	---------------------------	----	---------------------------	-------

Test Equipment List and Details:

Manufacturer	Description	Model	Serial Number	Calibration Date	Calibration Due Date
AH	Double Ridge Guide Horn Antenna	SAS-571	1394	2023/2/22	2026/2/21
R&S	Spectrum Analyzer	FSV40	101591	2023/3/31	2024/3/30
MICRO-COAX	Coaxial Cable	UFA210A-1-1200-70U300	217423-008	2023/8/6	2024/8/5
MICRO-COAX	Coaxial Cable	UFA210A-1-2362-300300	235780-001	2023/8/6	2024/8/5
Mini	Pre-amplifier	ZVA-183-S+	5969001149	2023/11/8	2024/11/7
Audix	Test Software	E3	201021 (V9)	N/A	N/A
PASTERNAK	Horn Antenna	PE9852/2F-20	112002	2021/2/5	2024/2/4
Quinstar	Preamplifier	QLW-18405536-JO	15964001005	2023/9/15	2024/9/14
MICRO-COAX	Coaxial Cable	UFB142A-1-2362-200200	235772-001	2023/8/6	2024/8/5
E-Microwave	Band Rejection Filter	2400-2483.5MHz	OE01902424	2023/8/6	2024/8/5
Mini Circuits	High Pass Filter	VHF-6010+	31119	2023/8/6	2024/8/5

* Statement of Traceability: China Certification ICT Co., Ltd (Dongguan) attests that all calibrations have been performed, traceable to National Primary Standards and International System of Units (SI).

Test Data:

After pre-scan in the X, Y and Z axes of orientation, the worst case is below:

BLE 1Mbps:

Frequency (MHz)	Receiver		Polar (H/V)	Factor (dB/m)	Result (dB μ V/m)	Limit (dB μ V/m)	Margin (dB)
	Reading (dB μ V)	Detector					
Low Channel:				2402	MHz		
2390.000	26.80	PK	H	31.71	58.51	74.00	15.49
2390.000	13.70	AV	H	31.71	45.41	54.00	8.59
2390.000	26.74	PK	V	31.71	58.45	74.00	15.55
2390.000	13.68	AV	V	31.71	45.39	54.00	8.61
4804.000	39.36	PK	H	11.19	50.55	74.00	23.45
4804.000	26.65	AV	H	11.19	37.84	54.00	16.16
4804.000	37.41	PK	V	11.19	48.60	74.00	25.40
4804.000	24.16	AV	V	11.19	35.35	54.00	18.65
7206.000	33.62	PK	H	15.03	48.65	74.00	25.35
7206.000	20.41	AV	H	15.03	35.44	54.00	18.56
7206.000	33.50	PK	V	15.03	48.53	74.00	25.47
7206.000	20.23	AV	V	15.03	35.26	54.00	18.74
Middle Channel:				2440	MHz		
4880.000	39.66	PK	H	11.48	51.14	74.00	22.86
4880.000	26.69	AV	H	11.48	38.17	54.00	15.83
4880.000	37.46	PK	V	11.48	48.94	74.00	25.06
4880.000	24.28	AV	V	11.48	35.76	54.00	18.24
7320.000	33.48	PK	H	15.58	49.06	74.00	24.94
7320.000	20.41	AV	H	15.58	35.99	54.00	18.01
7320.000	33.45	PK	V	15.58	49.03	74.00	24.97
7320.000	20.32	AV	V	15.58	35.90	54.00	18.10
High Channel:				2480	MHz		
2483.500	26.82	PK	H	32.19	59.01	74.00	14.99
2483.500	13.72	AV	H	32.19	45.91	54.00	8.09
2483.500	26.79	PK	V	32.19	58.98	74.00	15.02
2483.500	13.70	AV	V	32.19	45.89	54.00	8.11
4960.000	40.20	PK	H	11.77	51.97	74.00	22.03
4960.000	27.63	AV	H	11.77	39.40	54.00	14.60
4960.000	38.11	PK	V	11.77	49.88	74.00	24.12
4960.000	25.63	AV	V	11.77	37.40	54.00	16.60
7440.000	33.32	PK	H	15.98	49.30	74.00	24.70
7440.000	20.18	AV	H	15.98	36.16	54.00	17.84
7440.000	33.30	PK	V	15.98	49.28	74.00	24.72
7440.000	20.09	AV	V	15.98	36.07	54.00	17.93

BLE 2Mbps:

Frequency (MHz)	Receiver		Polar (H/V)	Factor (dB/m)	Result (dB μ V/m)	Limit (dB μ V/m)	Margin (dB)
	Reading (dB μ V)	Detector					
Low Channel:				2402	MHz		
2390.000	26.80	PK	H	31.71	58.51	74.00	15.49
2390.000	13.86	AV	H	31.71	45.57	54.00	8.43
2390.000	26.75	PK	V	31.71	58.46	74.00	15.54
2390.000	13.80	AV	V	31.71	45.51	54.00	8.49
4804.000	39.63	PK	H	11.19	50.82	74.00	23.18
4804.000	26.33	AV	H	11.19	37.52	54.00	16.48
4804.000	37.58	PK	V	11.19	48.77	74.00	25.23
4804.000	24.18	AV	V	11.19	35.37	54.00	18.63
7206.000	33.64	PK	H	15.03	48.67	74.00	25.33
7206.000	20.43	AV	H	15.03	35.46	54.00	18.54
7206.000	33.52	PK	V	15.03	48.55	74.00	25.45
7206.000	20.41	AV	V	15.03	35.44	54.00	18.56
Middle Channel:				2440	MHz		
4880.000	39.32	PK	H	11.48	50.80	74.00	23.20
4880.000	26.38	AV	H	11.48	37.86	54.00	16.14
4880.000	37.20	PK	V	11.48	48.68	74.00	25.32
4880.000	24.13	AV	V	11.48	35.61	54.00	18.39
7320.000	33.55	PK	H	15.58	49.13	74.00	24.87
7320.000	20.41	AV	H	15.58	35.99	54.00	18.01
7320.000	33.52	PK	V	15.58	49.10	74.00	24.90
7320.000	20.32	AV	V	15.58	35.90	54.00	18.10
High Channel:				2480	MHz		
2483.500	26.77	PK	H	32.19	58.96	74.00	15.04
2483.500	13.81	AV	H	32.19	46.00	54.00	8.00
2483.500	26.73	PK	V	32.19	58.92	74.00	15.08
2483.500	13.74	AV	V	32.19	45.93	54.00	8.07
4960.000	39.66	PK	H	11.77	51.43	74.00	22.57
4960.000	26.32	AV	H	11.77	38.09	54.00	15.91
4960.000	38.20	PK	V	11.77	49.97	74.00	24.03
4960.000	25.10	AV	V	11.77	36.87	54.00	17.13
7440.000	33.74	PK	H	15.98	49.72	74.00	24.28
7440.000	21.71	AV	H	15.98	37.69	54.00	16.31
7440.000	33.70	PK	V	15.98	49.68	74.00	24.32
7440.000	20.64	AV	V	15.98	36.62	54.00	17.38

Worst radiation spurious emissions margin test plots(BLE 1Mbps High Channel)

Project No.: CR231278742-RF
 Tester: Tao Zhu
 Polarization: horizontal
 Note: BLE

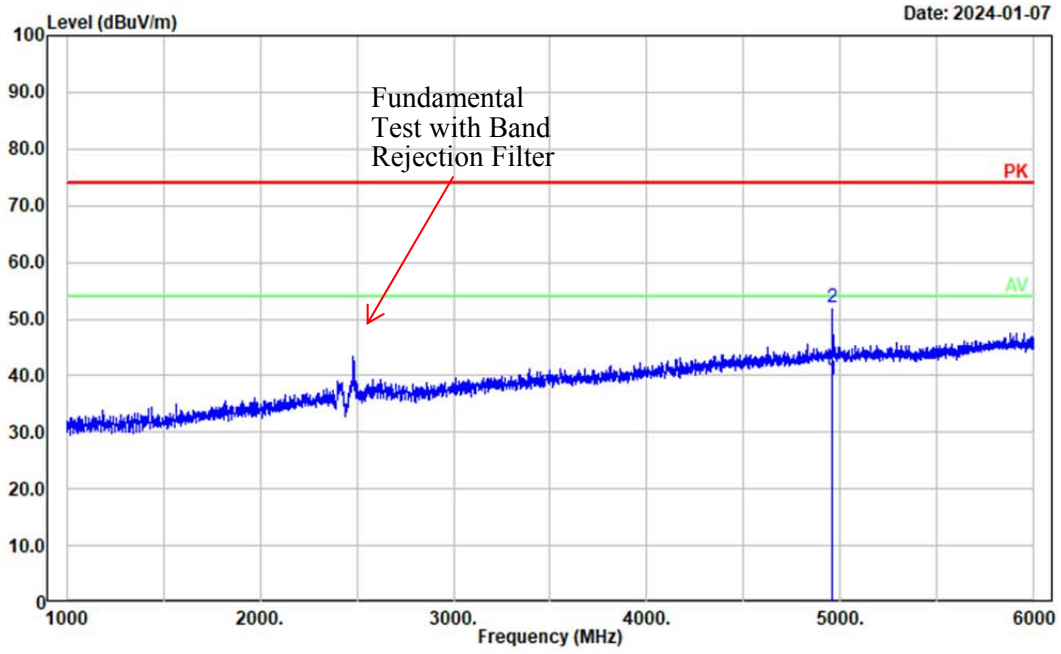

No.	Frequency (MHz)	Reading (dB μ V)	Factor (dB/m)	Result (dB μ V/m)	Limit (dB μ V/m)	Margin (dB)	Detector
1	4960.000	27.63	11.77	39.40	54.00	14.60	Average
2	4960.000	40.20	11.77	51.97	74.00	22.03	Peak

Project No.: CR231278742-RF
 Tester: Tao Zhu
 Polarization: Vertical
 Note: BLE

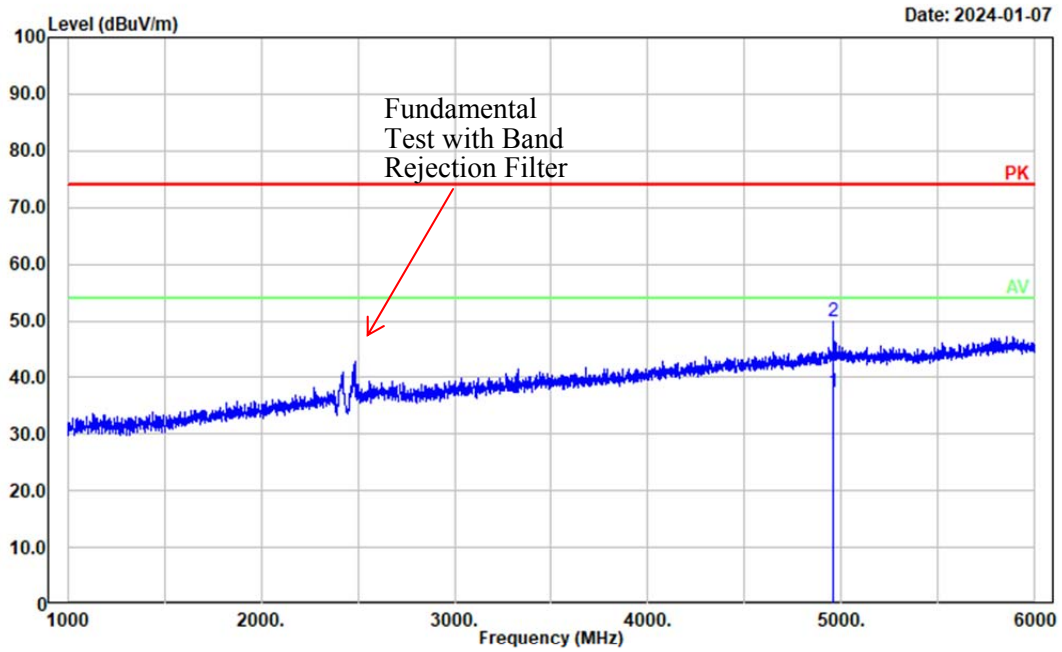

No.	Frequency (MHz)	Reading (dBμV)	Factor (dB/m)	Result (dBμV/m)	Limit (dBμV/m)	Margin (dB)	Detector
1	4960.000	25.63	11.77	37.40	54.00	16.60	Average
2	4960.000	38.11	11.77	49.88	74.00	24.12	Peak

Project No.: CR231278742-RF
 Tester: Tao Zhu
 Polarization: horizontal
 Note: BLE

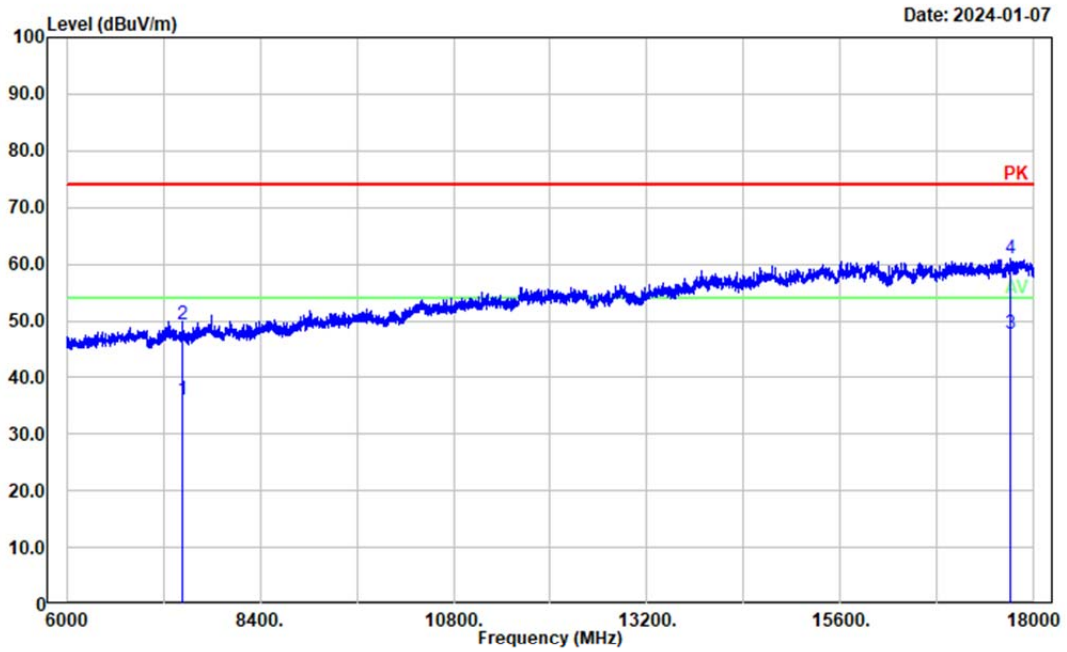

No.	Frequency (MHz)	Reading (dB μ V)	Factor (dB/m)	Result (dB μ V/m)	Limit (dB μ V/m)	Margin (dB)	Detector
1	7440.000	20.18	15.98	36.16	54.00	17.84	Average
2	7440.000	33.32	15.98	49.30	74.00	24.70	Peak
3	17714.400	16.31	31.31	47.62	54.00	6.38	Average
4	17714.400	29.67	31.31	60.98	74.00	13.02	Peak

Project No.: CR231278742-RF
 Tester: Tao Zhu
 Polarization: vertical
 Note: BLE

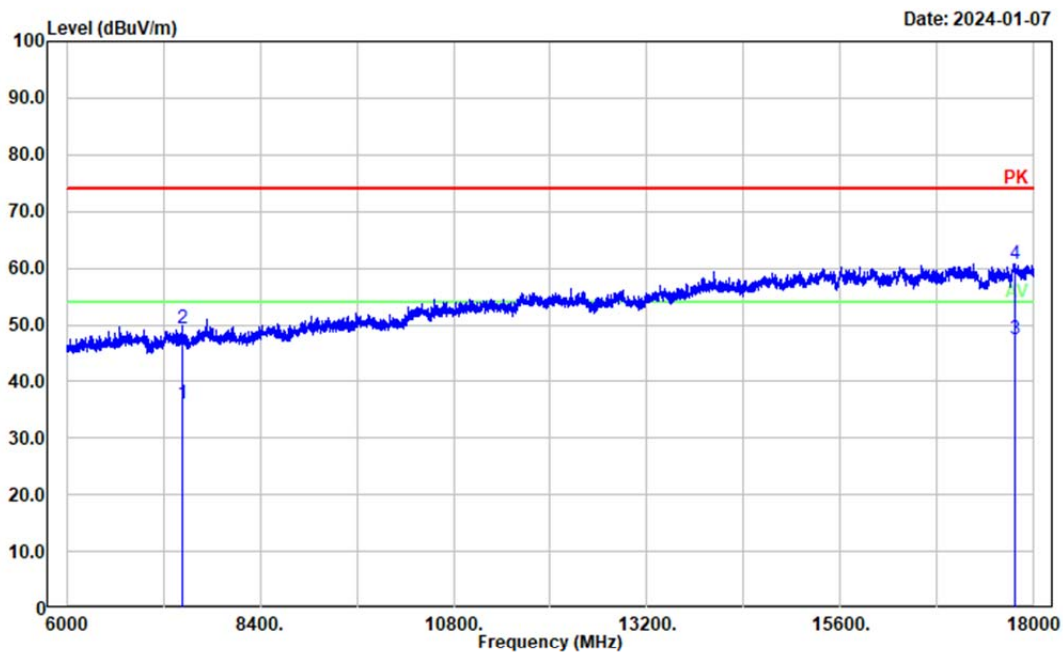

No.	Frequency (MHz)	Reading (dB μ V)	Factor (dB/m)	Result (dB μ V/m)	Limit (dB μ V/m)	Margin (dB)	Detector
1	7440.000	20.09	15.98	36.07	54.00	17.93	Average
2	7440.000	33.30	15.98	49.28	74.00	24.72	Peak
3	17767.200	15.83	31.50	47.33	54.00	6.67	Average
4	17767.200	29.17	31.50	60.67	74.00	13.33	Peak

Project No.: CR231278742-RF
 Tester: Tao Zhu
 Polarization: Horizontal
 Note: BLE

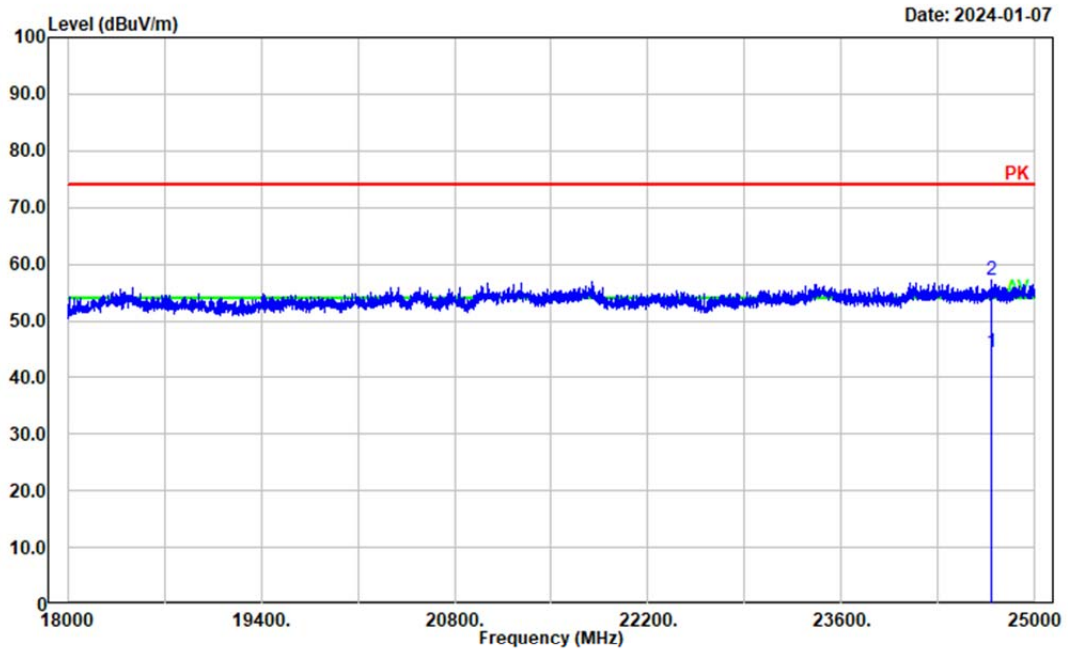

No.	Frequency (MHz)	Reading (dBμV)	Factor (dB/m)	Result (dBUV/m)	Limit (dBUV/m)	Margin (dB)	Detector
1	24689.200	39.18	5.39	44.57	54.00	9.43	Average
2	24689.200	51.70	5.39	57.09	74.00	16.91	Peak

Project No.: CR231278742-RF
 Tester: Tao Zhu
 Polarization: Vertical
 Note: BLE

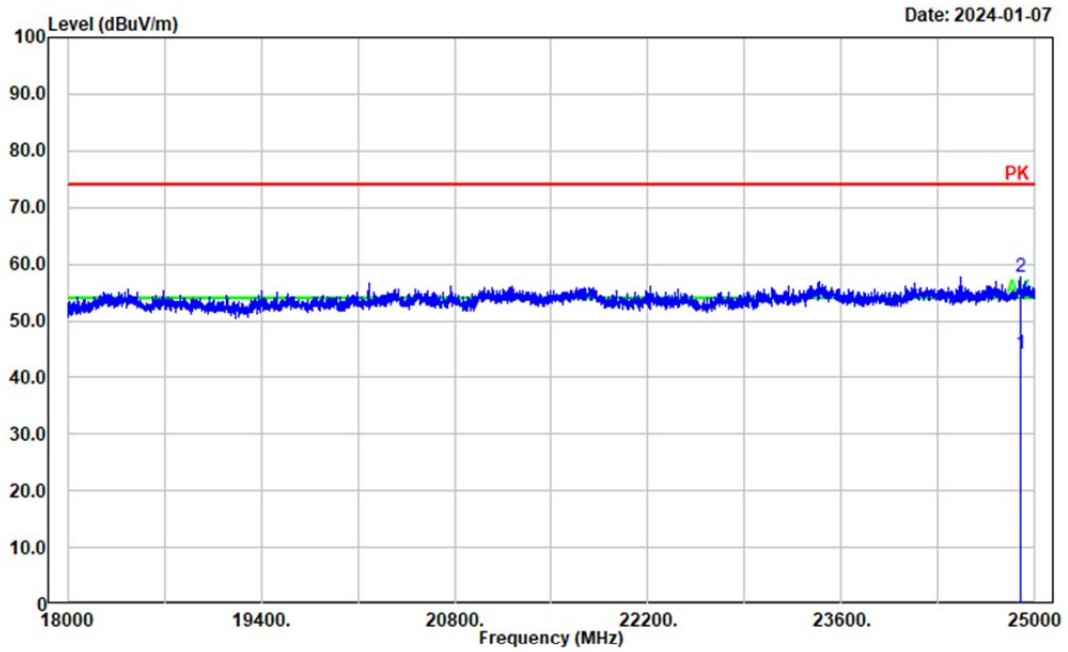

No.	Frequency (MHz)	Reading (dB μ V)	Factor (dB/m)	Result (dB μ V/m)	Limit (dB μ V/m)	Margin (dB)	Detector
1	24896.400	38.04	6.24	44.28	54.00	9.72	Average
2	24896.400	51.61	6.24	57.85	74.00	16.15	Peak

4.3 6dB Emission Bandwidth

Test Information:

Serial No.:	2FV7-1	Test Date:	2024/01/05
Test Site:	RF	Test Mode:	Transmitting
Tester:	Lingling Li	Test Result:	Pass

Environmental Conditions:

Temperature: (°C)	25.5	Relative Humidity: (%)	55	ATM Pressure: (kPa)	101.7
-----------------------------	------	----------------------------------	----	-------------------------------	-------

Test Equipment List and Details:

Manufacturer	Description	Model	Serial Number	Calibration Date	Calibration Due Date
R&S	Spectrum Analyzer	FSU26	100147	2023/03/31	2024/03/30
zhuoxiang	Coaxial Cable	SMA-178	211003	Each time	N/A

* Statement of Traceability: China Certification ICT Co., Ltd (Dongguan) attests that all calibrations have been performed, traceable to National Primary Standards and International System of Units (SI).

BLE 1M

Mode	Value (MHz)	Limit (MHz)	Result
Low	0.715	0.5	Pass
Middle	0.722	0.5	Pass
High	0.715	0.5	Pass

BLE 2M

Mode	Value (MHz)	Limit (MHz)	Result
Low	1.170	0.5	Pass
Middle	1.173	0.5	Pass
High	1.173	0.5	Pass

BLE 1M

Low 0.715 MHz

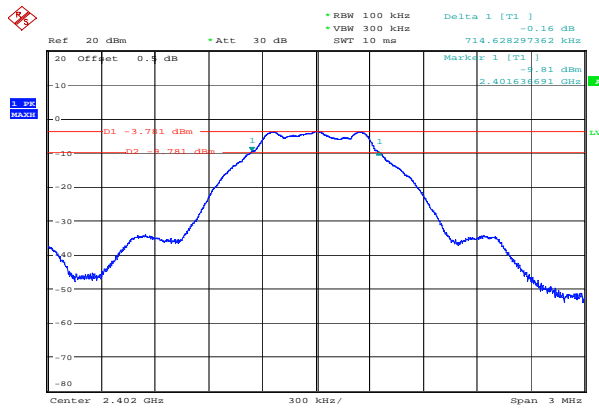

Comment: ProjectNo.:CR231278742-RF Tester:Lingling Li
Date: 5.JAN.2024 13:10:17

Middle 0.722 MHz

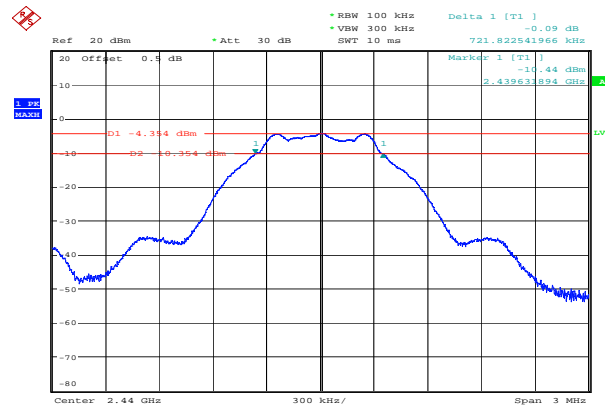

Comment: ProjectNo.:CR231278742-RF Tester:Lingling Li
Date: 5.JAN.2024 13:18:10

High 0.715 MHz

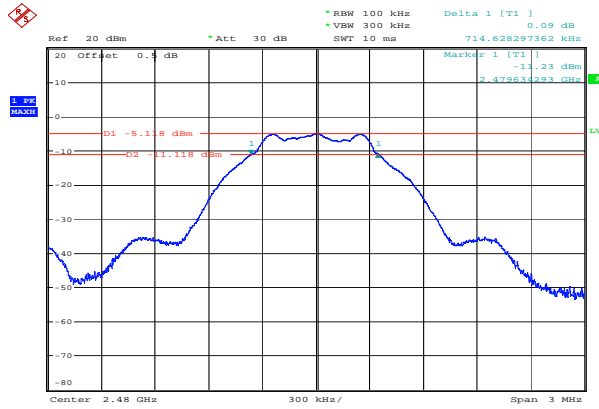

Comment: ProjectNo.:CR231278742-RF Tester:Lingling Li
Date: 5.JAN.2024 13:24:08

BLE 2M

Low 1.170 MHz

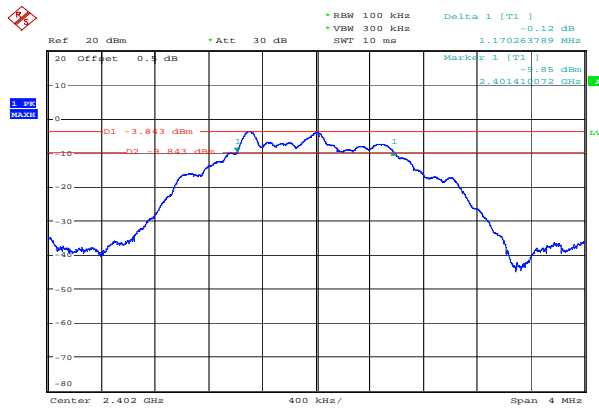

Comment: ProjectNo.:CR231278742-RF Tester:Lingling Li
Date: 5.JAN.2024 15:06:37

Middle 1.173 MHz

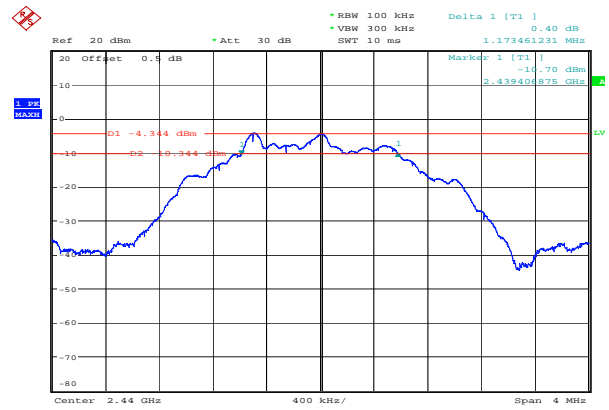

Comment: ProjectNo.:CR231278742-RF Tester:Lingling Li
Date: 5.JAN.2024 15:08:20

High 1.173 MHz

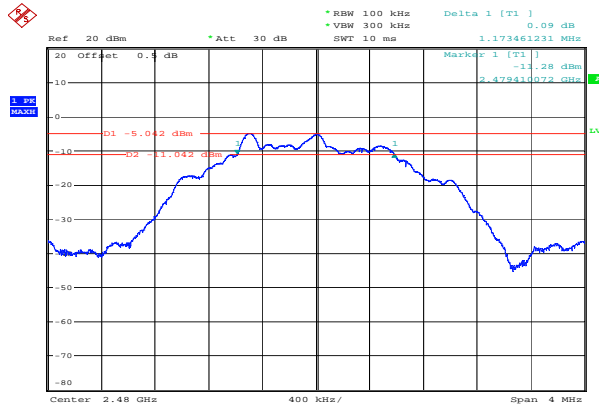

Comment: ProjectNo.:CR231278742-RF Tester:Lingling Li
Date: 5.JAN.2024 15:11:50

4.4 Maximum Conducted Output Power**Test Information:**

Serial No.:	2FV7-1	Test Date:	2024/01/11
Test Site:	RF	Test Mode:	Transmitting
Tester:	Lingling Li	Test Result:	Pass

Environmental Conditions:

Temperature: (°C)	24	Relative Humidity: (%)	57	ATM Pressure: (kPa)	101
-----------------------------	----	----------------------------------	----	-------------------------------	-----

Test Equipment List and Details:

Manufacturer	Description	Model	Serial Number	Calibration Date	Calibration Due Date
R&S	Spectrum Analyzer	FSU26	100147	2023/03/31	2024/03/30
zhuoxiang	Coaxial Cable	SMA-178	211003	Each time	N/A

* Statement of Traceability: China Certification ICT Co., Ltd (Dongguan) attests that all calibrations have been performed, traceable to National Primary Standards and International System of Units (SI).

BLE 1M

Mode	Value (dBm)	Limit (dBm)	Result
Low	-3.07	30.00	Pass
Middle	-3.65	30.00	Pass
High	-4.29	30.00	Pass

BLE 2M

Mode	Value (dBm)	Limit (dBm)	Result
Low	-3.17	30.00	Pass
Middle	-3.63	30.00	Pass
High	-4.22	30.00	Pass

BLE 1M

Low -3.07 dBm

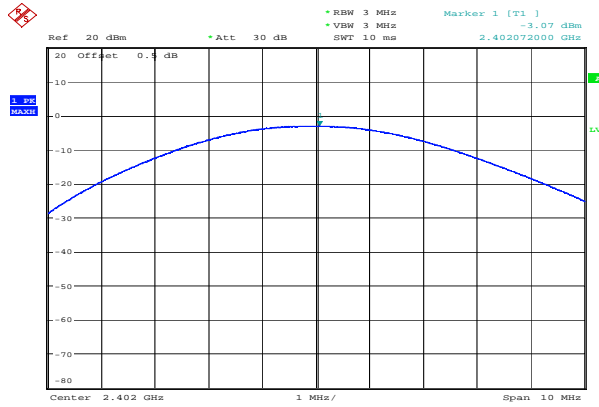

Comment: ProjectNo.:CR231278742-RF Tester:Lingling Li
Date: 11.JAN.2024 15:28:29

Middle -3.65 dBm

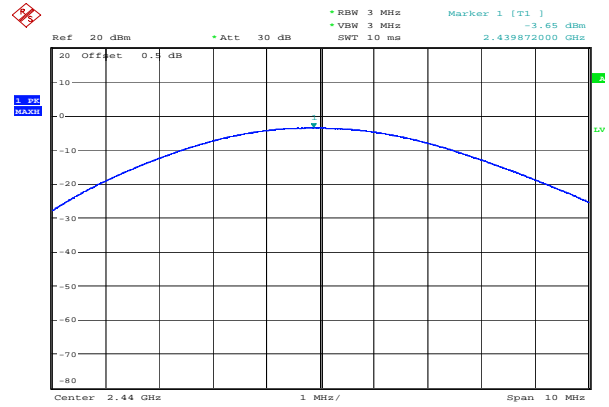

Comment: ProjectNo.:CR231278742-RF Tester:Lingling Li
Date: 11.JAN.2024 14:01:30

High -4.29 dBm

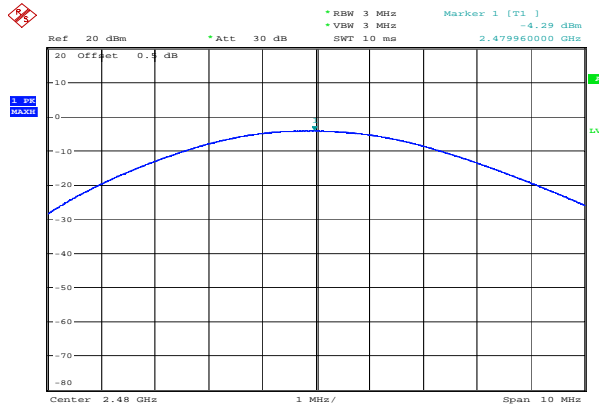

Comment: ProjectNo.:CR231278742-RF Tester:Lingling Li
Date: 11.JAN.2024 14:01:50

BLE 2M

Low -3.17 dBm

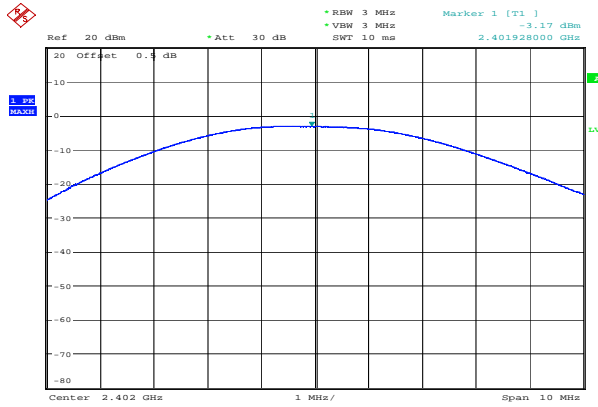

Comment: ProjectNo.:CR231278742-RF Tester:Lingling Li
Date: 11.JAN.2024 14:02:19

Middle -3.63 dBm

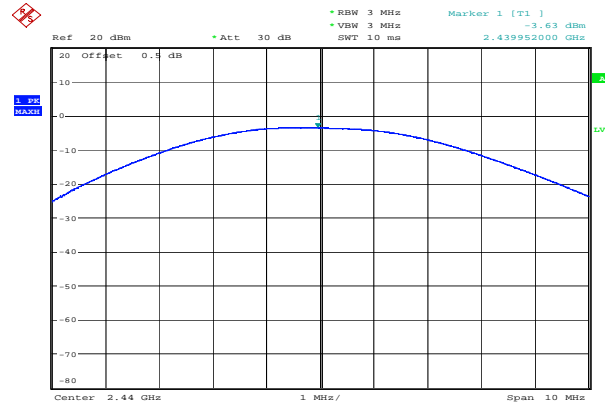

Comment: ProjectNo.:CR231278742-RF Tester:Lingling Li
Date: 11.JAN.2024 14:02:42

High -4.22 dBm

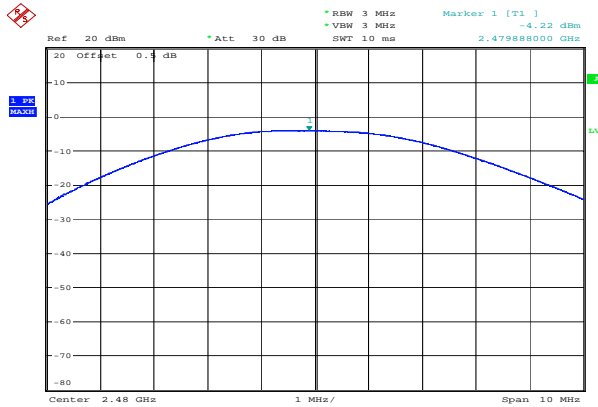

Comment: ProjectNo.:CR231278742-RF Tester:Lingling Li
Date: 11.JAN.2024 14:03:00

4.5 100 kHz Bandwidth of Frequency Band Edge**Test Information:**

Serial No.:	2FV7-1	Test Date:	2024/01/05
Test Site:	RF	Test Mode:	Transmitting
Tester:	Lingling Li	Test Result:	Pass

Environmental Conditions:

Temperature: (°C)	25.5	Relative Humidity: (%)	55	ATM Pressure: (kPa)	101.7
-----------------------------	------	----------------------------------	----	-------------------------------	-------

Test Equipment List and Details:

Manufacturer	Description	Model	Serial Number	Calibration Date	Calibration Due Date
R&S	Spectrum Analyzer	FSU26	100147	2023/03/31	2024/03/30
zhuoxiang	Coaxial Cable	SMA-178	211003	Each time	N/A

* Statement of Traceability: China Certification ICT Co., Ltd (Dongguan) attests that all calibrations have been performed, traceable to National Primary Standards and International System of Units (SI).

BLE 1M

Mode	Value (dB)	Limit (dB)	Result
Low	35.64	20.00	Pass
High	44.21	20.00	Pass

BLE 2M

Mode	Value (dB)	Limit (dB)	Result
Low	31.06	20.00	Pass
High	46.49	20.00	Pass

BLE 1M

Low 35.64 dB

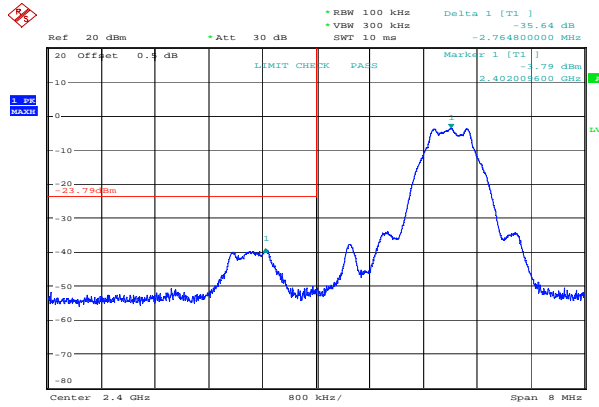

Comment: ProjectNo.:CR231278742-RF Tester:Lingling Li
Date: 5.JAN.2024 13:09:28

High 44.21 dB

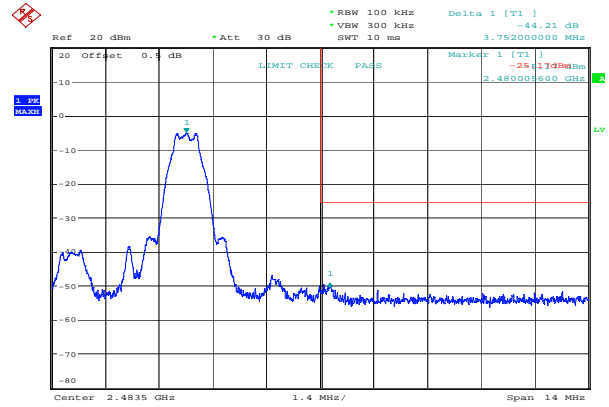

Comment: ProjectNo.:CR231278742-RF Tester:Lingling Li
Date: 5.JAN.2024 13:23:22

BLE 2M

Low 31.06 dB

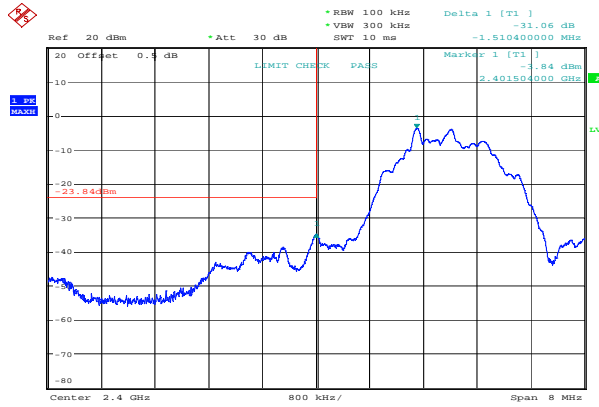

Comment: ProjectNo.:CR231278742-RF Tester:Lingling Li
Date: 5.JAN.2024 15:06:12

High 46.49 dB

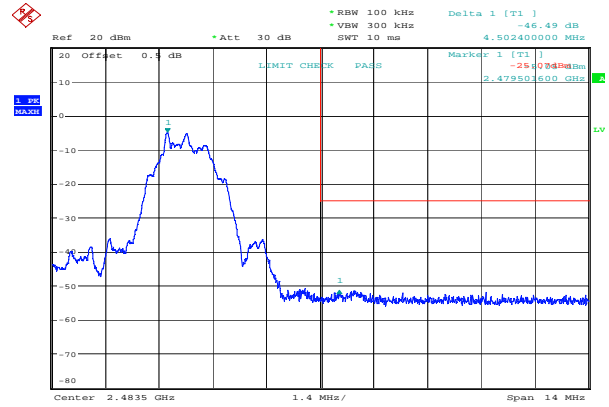

Comment: ProjectNo.:CR231278742-RF Tester:Lingling Li
Date: 5.JAN.2024 15:11:21

4.6 Power Spectral Density

Test Information:

Serial No.:	2FV7-1	Test Date:	2024/01/05
Test Site:	RF	Test Mode:	Transmitting
Tester:	Lingling Li	Test Result:	Pass

Environmental Conditions:

Temperature: (°C)	25.5	Relative Humidity: (%)	55	ATM Pressure: (kPa)	101.7
-----------------------------	------	----------------------------------	----	-------------------------------	-------

Test Equipment List and Details:

Manufacturer	Description	Model	Serial Number	Calibration Date	Calibration Due Date
R&S	Spectrum Analyzer	FSU26	100147	2023/03/31	2024/03/30
zhuoxiang	Coaxial Cable	SMA-178	211003	Each time	N/A

* *Statement of Traceability: China Certification ICT Co., Ltd (Dongguan) attests that all calibrations have been performed, traceable to National Primary Standards and International System of Units (SI).*

BLE 1M

Mode	Value (dBm/3kHz)	Limit (dBm/3kHz)	Result
Low	-18.45	8.00	Pass
Middle	-18.96	8.00	Pass
High	-19.66	8.00	Pass

BLE 2M

Mode	Value (dBm/3kHz)	Limit (dBm/3kHz)	Result
Low	-21.29	8.00	Pass
Middle	-21.60	8.00	Pass
High	-22.38	8.00	Pass

BLE 1M

Low -18.45 dBm/3kHz

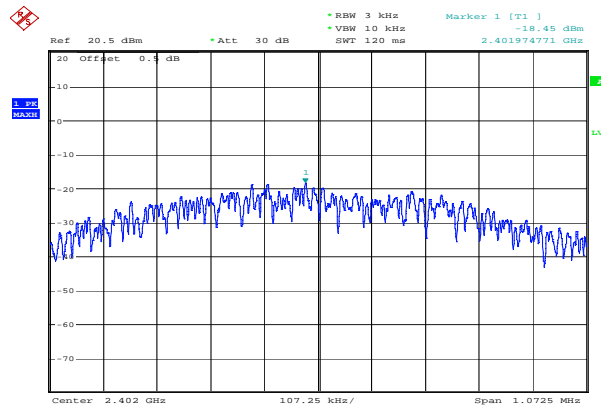

Comment: ProjectNo.:CR231278742-RF Tester:Lingling Li
Date: 5.JAN.2024 13:16:21

Middle -18.96 dBm/3kHz

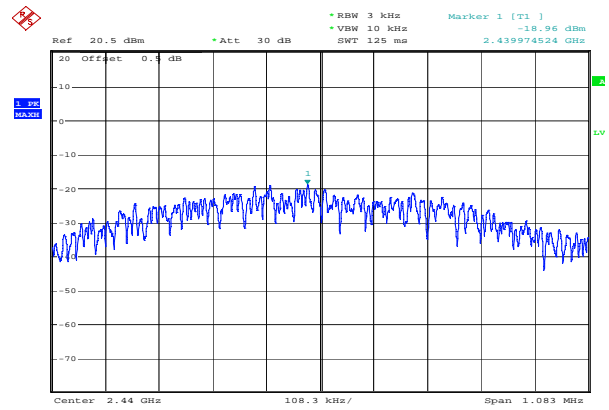

Comment: ProjectNo.:CR231278742-RF Tester:Lingling Li
Date: 5.JAN.2024 13:19:08

High -19.66dBm/3kHz

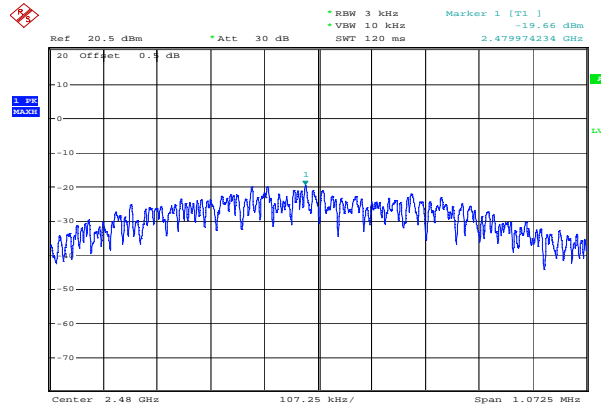

Comment: ProjectNo.:CR231278742-RF Tester:Lingling Li
Date: 5.JAN.2024 13:24:48

BLE 2M

Low -21.29 dBm/3kHz

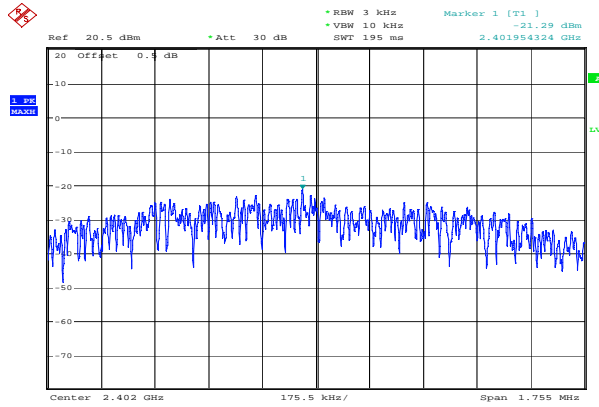

Comment: ProjectNo.:CR231278742-RF Tester:Lingling Li
Date: 5.JAN.2024 15:07:03

Middle -21.60 dBm/3kHz

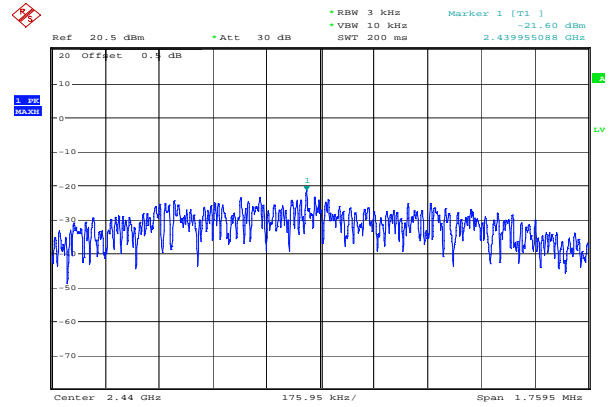

Comment: ProjectNo.:CR231278742-RF Tester:Lingling Li
Date: 5.JAN.2024 15:09:01

High -22.38 dBm/3kHz

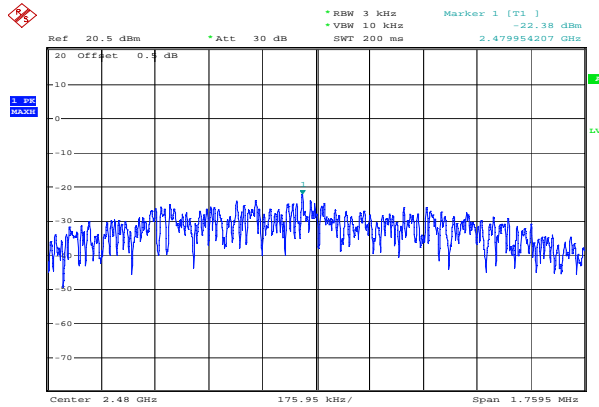

Comment: ProjectNo.:CR231278742-RF Tester:Lingling Li
Date: 5.JAN.2024 15:12:23

4.7 Duty Cycle**Test Information:**

Serial No.:	2FV7-1	Test Date:	2024/01/05
Test Site:	RF	Test Mode:	Transmitting
Tester:	Lingling Li	Test Result:	Pass

Environmental Conditions:

Temperature: (°C)	25.5	Relative Humidity: (%)	55	ATM Pressure: (kPa)	101.7
-----------------------------	------	----------------------------------	----	-------------------------------	-------

Test Equipment List and Details:

Manufacturer	Description	Model	Serial Number	Calibration Date	Calibration Due Date
R&S	Spectrum Analyzer	FSU26	100147	2023/03/31	2024/03/30
zhuoxiang	Coaxial Cable	SMA-178	211003	Each time	N/A

** Statement of Traceability: China Certification ICT Co., Ltd (Dongguan) attests that all calibrations have been performed, traceable to National Primary Standards and International System of Units (SI).*

BLE 1M

Mode	Ton (ms)	Ton+Toff (ms)	Duty Cycle (%)	1/T (Hz)	VBW Setting (kHz)	Result
Middle	0.394	0.630	62.600	2539	3	Pass

BLE 2M

Mode	Ton (ms)	Ton+Toff (ms)	Duty Cycle (%)	1/T (Hz)	VBW Setting (kHz)	Result
Middle	0.216	0.633	34.120	4630	5	Pass

Duty Cycle = Ton/(Ton+Toff)*100%

BLE 1M

Middle
0.394 ms,0.63ms

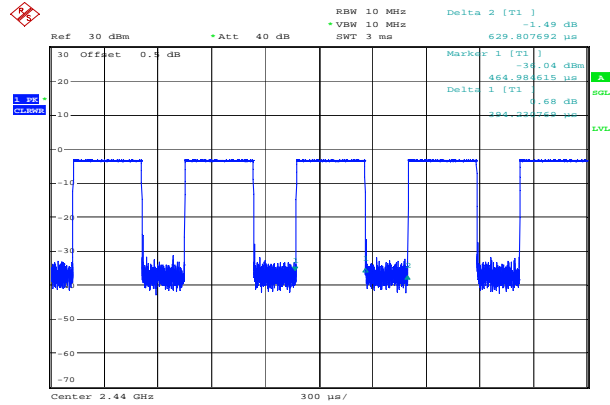

Comment: ProjectNo.:CR231278742-RF Tester:Lingling Li
Date: 5.JAN.2024 13:18:48

BLE 2M

Middle
0.216 ms,0.633ms

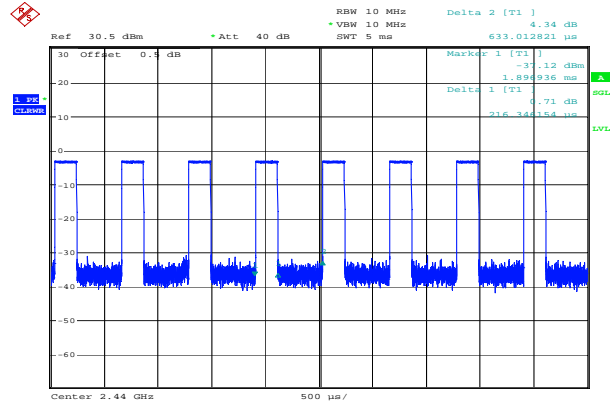

Comment: ProjectNo.:CR231278742-RF Tester:Lingling Li
Date: 5.JAN.2024 14:17:35

5. RF EXPOSURE EVALUATION

5.1 Applicable Standard

According to §15.247(i) and §1.1310, systems operating under the provisions of this section shall be operated in a manner that ensure that the public is not exposed to radio frequency energy level in excess of the Commission's guideline.

According to KDB447498 D01 General RF Exposure Guidance v06:

The 1-g and 10-g SAR test exclusion thresholds for 100 MHz to 6 GHz at test separation distances \leq 50 mm are determined by:

$[(\text{max. power of channel, including tune-up tolerance, mW})/(\text{min. test separation distance, mm})] \cdot [\sqrt{f(\text{GHz})}] \leq 3.0$ for 1-g SAR and ≤ 7.5 for 10-g extremity SAR, where

- $f(\text{GHz})$ is the RF channel transmit frequency in GHz
- Power and distance are rounded to the nearest mW and mm before calculation
- The result is rounded to one decimal place for comparison
- 3.0 and 7.5 are referred to as the numeric thresholds in the step 2 below

The test exclusions are applicable only when the minimum test separation distance is \leq 50 mm and for transmission frequencies between 100 MHz and 6 GHz. When the minimum test separation distance is $<$ 5 mm, a distance of 5 mm according to 5) in section 4.1 is applied to determine SAR test exclusion.

5.2 Measurement Result

The max conducted power including tune-up tolerance is -3 dBm (0.5mW).

$[(\text{max. power of channel, mW})/(\text{min. test separation distance, mm})][\sqrt{f(\text{GHz})}]$
 $= 0.5/5 \cdot (\sqrt{2.480}) = 0.2 < 3.0$

Result: Compliant. The stand-alone SAR evaluation is not necessary.

6. EUT PHOTOGRAPHS

Please refer to the attachment CR231278742-EXPEUT EXTERNAL PHOTOGRAPHS and CR231278742-INPEUT INTERNAL PHOTOGRAPHS

7. TEST SETUP PHOTOGRAPHS

Please refer to the attachment CR231278742-00B-TSP TEST SETUP PHOTOGRAPHS.

===== END OF REPORT =====