

FCC Test Report

Applicant : Shenzhen Raycloud Technology Co.,Ltd

Address : Bulong Road No.663,Building F,4th Floor,411A,
Dafabu Community, Bantian Street, Longgang
District, Shenzhen, Guangdong, China

Product Name : Wi-Fi Doorbell Base Station

Report Date : Mar. 14, 2024



Shenzhen Anbotek Compliance Laboratory Limited

Shenzhen Anbotek Compliance Laboratory Limited

Address: 1/F., Building D, Sogood Science and Technology Park, Sanwei Community,
Hangcheng Street, Bao'an District, Shenzhen, Guangdong, China.
Tel:(86)0755-26066440 Fax:(86)0755-26014772 Email:service@anbotek.com



Hotline
400-003-0500
www.anbotek.com.cn



Contents

1. General Information	6
1.1. Client Information	6
1.2. Description of Device (EUT)	6
1.3. Auxiliary Equipment Used During Test	8
1.4. Operation channel list	9
1.5. Description of Test Modes	10
1.6. Measurement Uncertainty	10
1.7. Test Summary	11
1.8. Description of Test Facility	12
1.9. Disclaimer	12
1.10. Test Equipment List	13
2. Conducted Emission at AC power line	15
2.1. EUT Operation	15
2.2. Test Setup	15
2.3. Test Data	16
3. Duty Cycle	18
3.1. EUT Operation	18
3.2. Test Setup	18
3.3. Test Data	18
4. Maximum conducted output power	19
4.1. EUT Operation	19
4.2. Test Setup	20
4.3. Test Data	20
5. Power spectral density	21
5.1. EUT Operation	21
5.2. Test Setup	22
5.3. Test Data	22
6. Emission bandwidth and occupied bandwidth	23
6.1. EUT Operation	24
6.2. Test Setup	24
6.3. Test Data	25
7. Channel Move Time, Channel Closing Transmission Time	26
7.1. EUT Operation	27
7.2. Test Setup	27
7.3. Test Data	27
8. DFS Detection Thresholds	28
8.1. EUT Operation	28
8.2. Test Setup	29
8.3. Test Data	29
9. Band edge emissions (Radiated)	30
9.1. EUT Operation	32

Shenzhen Anbotek Compliance Laboratory Limited

Address: 1/F., Building D, Sogood Science and Technology Park, Sanwei Community, Hangcheng Street, Bao'an District, Shenzhen, Guangdong, China.
Tel: (86)0755-26066440 Fax: (86)0755-26014772 Email: service@anbotek.com



Hotline
400-003-0500
www.anbotek.com.cn



9.2. Test Setup	32
9.3. Test Data	33
10. Band edge emissions (Conducted)	35
10.1. EUT Operation	35
10.2. Test Setup	35
10.3. Test Data	35
11. Undesirable emission limits (below 1GHz)	36
11.1. EUT Operation	38
11.2. Test Setup	38
11.3. Test Data	39
12. Undesirable emission limits (above 1GHz)	41
12.1. EUT Operation	43
12.2. Test Setup	43
12.3. Test Data	44
APPENDIX I -- TEST SETUP PHOTOGRAPH	48
APPENDIX II -- EXTERNAL PHOTOGRAPH	48
APPENDIX III -- INTERNAL PHOTOGRAPH	48



Report No.: 18220WC30275503

FCC ID: 2A86W-S1

Page 4 of 48

TEST REPORT

Applicant : Shenzhen Raycloud Technology Co.,Ltd

Manufacturer : Shenzhen Raycloud Technology Co.,Ltd

Product Name : Wi-Fi Doorbell Base Station

Test Model No. : S1

Reference Model No. : N/A

Trade Mark : 

Rating(s) : Input: 100-240VAC,50/60Hz,3.5W

47 CFR Part 15E**Test Standard(s) : ANSI C63.10-2020****KDB 789033 D02 General UNII Test Procedures New Rules v02r01****KDB 905462 D02 UNII DFS Compliance Procedures New Rules v02**

The device described above is tested by Shenzhen Anbotek Compliance Laboratory Limited to determine the maximum emission levels emanating from the device and the severe levels of the device can endure and its performance criterion. The measurement results are contained in this test report and Shenzhen Anbotek Compliance Laboratory Limited is assumed full of responsibility for the accuracy and completeness of these measurements. Also, this report shows that the EUT (Equipment Under Test) is technically compliant with above listed standard(s) requirements. This report applies to above tested sample only and shall not be reproduced in part without written approval of Shenzhen Anbotek Compliance Laboratory Limited.

Date of Receipt:

Jan. 15, 2024

Date of Test:

Jan. 15, 2024 ~ Feb. 28, 2024

Prepared By:



(Ella Liang)

Approved & Authorized Signer:



(Edward Pan)

Shenzhen Anbotek Compliance Laboratory Limited

Address: 1/F., Building D, Sogood Science and Technology Park, Sanwei Community, Hangcheng Street, Bao'an District, Shenzhen, Guangdong, China.
Tel: (86)0755-26066440 Fax: (86)0755-26014772 Email: service@anbotek.com



Hotline

400-003-0500

www.anbotek.com.cn



Revision History

Report Version	Description	Issued Date
R00	Original Issue.	Mar. 14, 2024

Shenzhen Anbotek Compliance Laboratory Limited

Address: 1/F., Building D, Sogood Science and Technology Park, Sanwei Community, Hangcheng Street, Bao'an District, Shenzhen, Guangdong, China.
Tel: (86)0755-26066440 Fax: (86)0755-26014772 Email: service@anbotek.com



Hotline
400-003-0500
www.anbotek.com.cn



1. General Information

1.1. Client Information

Applicant	:	Shenzhen Raycloud Technology Co.,Ltd
Address	:	Bulong Road No.663,Building F,4th Floor,411A, Dafabu Community, Bantian Street, Longgang District, Shenzhen, Guangdong, China
Manufacturer	:	Shenzhen Raycloud Technology Co.,Ltd
Address	:	Bulong Road No.663,Building F,4th Floor,411A, Dafabu Community, Bantian Street, Longgang District, Shenzhen, Guangdong, China
Factory	:	Shenzhen Raycloud Technology Co.,Ltd
Address	:	Bulong Road No.663,Building F,4th Floor,411A, Dafabu Community, Bantian Street, Longgang District, Shenzhen, Guangdong, China

1.2. Description of Device (EUT)

Product Name	:	Wi-Fi Doorbell Base Station
Test Model No.	:	S1
Reference Model No.	:	N/A
Trade Mark	:	
Test Power Supply	:	AC 120V/60Hz
Test Sample No.	:	1-2-1(Normal Sample), 1-2-2(Engineering Sample)
Adapter	:	N/A
RF Specification (Module: RTL8731BU)		
Operation Frequency	:	802.11a/n(HT20): U-NII Band 1: 5180MHz to 5240MHz; U-NII Band 2A: 5260MHz to 5320MHz; U-NII Band 2C: 5500MHz to 5700MHz; U-NII Band 3: 5745MHz to 5825MHz
Number of Channel	:	802.11a/n(HT20): U-NII Band 1: 4; U-NII Band 2A: 4; U-NII Band 2C: 11; U-NII Band 3: 5
Modulation Type	:	802.11a: OFDM(BPSK, QPSK, 16QAM, 64QAM); 802.11n: OFDM (BPSK, QPSK, 16QAM, 64QAM)
Antenna Type	:	Rod Antenna
Antenna Gain(Peak)	:	WiFi 5.2G: 3.08dBi WiFi 5.3G: 3.08dBi WiFi 5.6G: 3.08dBi WiFi 5.8G: 3.08dBi
Device Type	:	<input type="checkbox"/> Outdoor AP <input type="checkbox"/> Indoor AP <input type="checkbox"/> Point-to-point AP

Shenzhen Anbotek Compliance Laboratory Limited

Address: 1/F., Building D, Sogood Science and Technology Park, Sanwei Community, Hangcheng Street, Bao'an District, Shenzhen, Guangdong, China.
Tel: (86)0755-26066440 Fax: (86)0755-26014772 Email: service@anbotek.com



Hotline
400-003-0500
www.anbotek.com.cn



	<input checked="" type="checkbox"/> Client		
TPC Function	:	<input checked="" type="checkbox"/> With TPC	<input checked="" type="checkbox"/> Without TPC
DFS Type	:	<input checked="" type="checkbox"/> Slave without radar detection	<input type="checkbox"/> Slave with radar detection
Remark: (1) All of the RF specification are provided by customer. (2) For a more detailed features description, please refer to the manufacturer's specifications or the User's Manual.			

Shenzhen Anbotek Compliance Laboratory Limited

Address: 1/F., Building D, Sogood Science and Technology Park, Sanwei Community, Hangcheng Street, Bao'an District, Shenzhen, Guangdong, China.
Tel: (86)0755-26066440 Fax: (86)0755-26014772 Email: service@anbotek.com



Hotline
400-003-0500
www.anbotek.com.cn



1.3. Auxiliary Equipment Used During Test

Title	Manufacturer	Model No.	Serial No.
AX1500 Wi-Fi 6 Router	Micronet Union Technology(Chengdu) Co., Ltd	T262-T21D (FCC ID: 2A22E-WWYLT262)	/

Shenzhen Anbotek Compliance Laboratory Limited

Address: 1/F., Building D, Sogood Science and Technology Park, Sanwei Community,
Hangcheng Street, Bao'an District, Shenzhen, Guangdong, China.
Tel: (86)0755-26066440 Fax: (86)0755-26014772 Email: service@anbotek.com



Hotline
400-003-0500
www.anbotek.com.cn



1.4. Operation channel list

Operation Band: U-NII Band 1

Bandwidth:	20MHz	/	/	/	/
Channel	Frequency (MHz)	/	/	/	/
36	5180	/	/	/	/
40	5200	/	/	/	/
44	5220	/	/	/	/
48	5240	/	/	/	/

Operation Band: U-NII Band 2A

Bandwidth:	20MHz	/	/	/	/
Channel	Frequency (MHz)	/	/	/	/
52	5260	/	/	/	/
56	5280	/	/	/	/
60	5300	/	/	/	/
64	5320	/	/	/	/

Operation Band: U-NII Band 2C

Bandwidth:	20MHz	/	/	/	/
Channel	Frequency (MHz)	/	/	/	/
100	5500	/	/	/	/
104	5520	/	/	/	/
108	5540	/	/	/	/
112	5560	/	/	/	/
116	5580	/	/	/	/
120	5600	/	/	/	/
124	5620	/	/	/	/
128	5640	/	/	/	/
132	5660	/	/	/	/
136	5680	/	/	/	/
140	5700	/	/	/	/

Shenzhen Anbotek Compliance Laboratory Limited

Address: 1/F., Building D, Sogood Science and Technology Park, Sanwei Community, Hangcheng Street, Bao'an District, Shenzhen, Guangdong, China.
 Tel: (86)0755-26066440 Fax: (86)0755-26014772 Email: service@anbotek.com



Hotline
 400-003-0500
www.anbotek.com.cn



Operation Band: U-NII Band 3

Bandwidth:	20MHz	/	/	/	/
Channel	Frequency (MHz)	/	/	/	/
149	5745	/	/	/	/
153	5765	/	/	/	/
157	5785	/	/	/	/
161	5805	/	/	/	/
165	5825	/	/	/	/

1.5. Description of Test Modes

Pretest Modes	Descriptions
TM1	Keep the EUT connect to AC power line and works in continuously transmitting mode with 802.11a modulation type. All data rates has been tested and found the data rate @ 6Mbps is the worst case. Only the data of worst case is recorded in the report.
TM2	Keep the EUT connect to AC power line and works in continuously transmitting mode with 802.11n modulation type. All bandwidth and data rates has been tested and found the data rate @ MCS0 is the worst case. Only the data of worst case is recorded in the report.
TM3	Keep the EUT works in normal operating mode and connect to companion device

1.6. Measurement Uncertainty

Parameter	Uncertainty
Conducted emissions (AMN 150kHz~30MHz)	3.4dB
Conducted Output Power	0.76dB
Power Spectral Density	0.76dB
Occupied Bandwidth	925Hz
Radiated spurious emissions (above 1GHz)	1G-6GHz: 4.78dB; 6G-18GHz: 4.88dB 18G-40GHz: 5.68dB
Radiated emissions (Below 30MHz)	3.53dB
Radiated spurious emissions (30MHz~1GHz)	Horizontal: 3.92dB; Vertical: 4.52dB

The measurement uncertainty and decision risk evaluated according to AB/WI-RF-F-032. This uncertainty represents an expanded uncertainty expressed at approximately the 95% confidence level using a coverage factor of k=2.



1.7. Test Summary

Test Items	Test Modes	Status
Conducted Emission at AC power line	Mode1,2	P
Duty Cycle	Mode1,2	P
Maximum conducted output power	Mode1,2	P
Power spectral density	Mode1,2	P
Emission bandwidth and occupied bandwidth	Mode1,2	P
Channel Move Time, Channel Closing Transmission Time	Mode3	P
DFS Detection Thresholds	Mode3	P
Band edge emissions (Radiated)	Mode1,2	P
Band edge emissions (Conducted)	Mode1,2,3	P
Undesirable emission limits (below 1GHz)	Mode1,2	P
Undesirable emission limits (above 1GHz)	Mode1,2	P
Note: P: Pass N: N/A, not applicable		

Shenzhen Anbotek Compliance Laboratory Limited

Address: 1/F., Building D, Sogood Science and Technology Park, Sanwei Community,
Hangcheng Street, Bao'an District, Shenzhen, Guangdong, China.
Tel: (86)0755-26066440 Fax: (86)0755-26014772 Email: service@anbotek.com



Hotline
400-003-0500
www.anbotek.com.cn



1.8. Description of Test Facility

The test facility is recognized, certified, or accredited by the following organizations:

FCC-Registration No.:434132

Shenzhen Anbotek Compliance Laboratory Limited, EMC Laboratory has been registered and fully described in a report filed with the (FCC) Federal Communications Commission. The acceptance letter from the FCC is maintained in our files. Registration No. 434132.

ISED-Registration No.: 8058A

Shenzhen Anbotek Compliance Laboratory Limited, EMC Laboratory has been registered and fully described in a report filed with the (ISED) Innovation, Science and Economic Development Canada. The acceptance letter from the ISED is maintained in our files. Registration 8058A.

Test Location

Shenzhen Anbotek Compliance Laboratory Limited.

1/F, Building D, Sogood Science and Technology Park, Sanwei community, Hangcheng Street, Bao'an District, Shenzhen, Guangdong, China.

1.9. Disclaimer

1. The test report is invalid if not marked with the signatures of the persons responsible for preparing and approving the test report.
2. The test report is invalid if there is any evidence and/or falsification.
3. The results documented in this report apply only to the tested sample, under the conditions and modes of operation as described herein.
4. This document may not be altered or revised in any way unless done so by Anbotek and all revisions are duly noted in the revisions section.
5. Content of the test report, in part or in full, cannot be used for publicity and/or promotional purposes without prior written approval from the laboratory.
6. The authenticity of the information provided by the customer is the responsibility of the customer and the laboratory is not responsible for its authenticity.

The laboratory is only responsible for the data released by the laboratory, except for the part provided by the applicant.

Shenzhen Anbotek Compliance Laboratory Limited

Address: 1/F., Building D, Sogood Science and Technology Park, Sanwei Community, Hangcheng Street, Bao'an District, Shenzhen, Guangdong, China.
Tel: (86)0755-26066440 Fax: (86)0755-26014772 Email: service@anbotek.com



Hotline
400-003-0500
www.anbotek.com.cn



1.10. Test Equipment List

Conducted Emission at AC power line						
Item	Equipment	Manufacturer	Model No.	Serial No.	Last Cal.	Cal.Due Date
1	L.I.S.N. Artificial Mains Network	Rohde & Schwarz	ENV216	100055	2023-10-12	2024-10-11
2	Three Phase V-type Artificial Power Network	CYBERTEK	EM5040DT	E215040D T001	2023-07-05	2024-07-04
3	EMI Test Receiver	Rohde & Schwarz	ESCI	100627	2023-10-12	2024-10-11
4	Software Name EZ-EMC	Farad Technology	ANB-03A	N/A	/	/

Duty Cycle

Maximum conducted output power

Power spectral density

Emission bandwidth and occupied bandwidth

Band edge emissions (Conducted)

Channel Move Time, Channel Closing Transmission Time

DFS Detection Thresholds

Item	Equipment	Manufacturer	Model No.	Serial No.	Last Cal.	Cal.Due Date
1	Constant Temperature Humidity Chamber	ZHONGJIAN	ZJ-KHWS80B	N/A	2023-10-16	2024-10-15
2	DC Power Supply	IVYTECH	IV3605	1804D360 510	2023-10-20	2024-10-19
3	Spectrum Analyzer	Rohde & Schwarz	FSV40-N	101792	2023-05-26	2024-05-25
4	MXA Spectrum Analysis	KEYSIGHT	N9020A	MY505318 23	2023-02-23	2024-02-22
5	Oscilloscope	Tektronix	MDO3012	C020298	2023-10-12	2024-10-11
6	MXG RF Vector Signal Generator	Agilent	N5182A	MY474206 47	2023-02-23	2024-10-22

Shenzhen Anbotek Compliance Laboratory Limited

Address: 1/F., Building D, Sogood Science and Technology Park, Sanwei Community, Hangcheng Street, Bao'an District, Shenzhen, Guangdong, China.
 Tel: (86)0755-26066440 Fax: (86)0755-26014772 Email: service@anbotek.com



Hotline
400-003-0500
www.anbotek.com.cn



Band edge emissions (Radiated) Undesirable emission limits (above 1GHz)						
Item	Equipment	Manufacturer	Model No.	Serial No.	Last Cal.	Cal.Due Date
1	EMI Test Receiver	Rohde & Schwarz	ESR26	101481	2023-10-12	2024-10-11
2	EMI Preamplifier	SKET Electronic	LNPA-0118G-45	SKET-PA-002	2023-10-12	2024-10-11
3	Double Ridged Horn Antenna	SCHWARZBECK	BBHA 9120D	02555	2022-10-16	2025-10-15
4	EMI Test Software EZ-EMC	SHURPLE	N/A	N/A	/	/
5	Horn Antenna	A-INFO	LB-180400-KF	J211060628	2023-10-12	2024-10-11
6	Spectrum Analyzer	Rohde & Schwarz	FSV40-N	101792	2023-05-26	2024-05-25
7	Amplifier	Talent Microwave	TLLA18G40 G-50-30	23022802	2023-05-25	2024-05-24

Undesirable emission limits (below 1GHz)						
Item	Equipment	Manufacturer	Model No.	Serial No.	Last Cal.	Cal.Due Date
1	EMI Test Receiver	Rohde & Schwarz	ESR26	101481	2023-10-12	2024-10-11
2	Pre-amplifier	SONOMA	310N	186860	2023-10-12	2024-10-11
3	Bilog Broadband Antenna	Schwarzbeck	VULB9163	345	2022-10-23	2025-10-22
4	Loop Antenna (9K-30M)	Schwarzbeck	FMZB1519 B	00053	2023-10-12	2024-10-11
5	EMI Test Software EZ-EMC	SHURPLE	N/A	N/A	/	/

Shenzhen Anbotek Compliance Laboratory Limited

Address: 1/F., Building D, Sogood Science and Technology Park, Sanwei Community, Hangcheng Street, Bao'an District, Shenzhen, Guangdong, China.
Tel: (86)0755-26066440 Fax: (86)0755-26014772 Email: service@anbotek.com



Hotline
400-003-0500
www.anbotek.com.cn



2. Conducted Emission at AC power line

Test Requirement:	47 CFR Part 15.207(a)		
Test Limit:	Frequency of emission (MHz)	Conducted limit (dBμV)	
		Quasi-peak	Average
	0.15-0.5	66 to 56*	56 to 46*
	0.5-5	56	46
	5-30	60	50
*Decreases with the logarithm of the frequency.			
Test Method:	ANSI C63.10-2020 section 6.2		

2.1. EUT Operation

Operating Environment:	
Test mode:	<p>1: 802.11a mode: Keep the EUT connect to AC power line and works in continuously transmitting mode with 802.11a modulation type. All data rates has been tested and found the data rate @ 6Mbps is the worst case. Only the data of worst case is recorded in the report.</p> <p>2: 802.11n mode: Keep the EUT connect to AC power line and works in continuously transmitting mode with 802.11n modulation type. All bandwidth and data rates has been tested and found the data rate @ MCS0 is the worst case. Only the data of worst case is recorded in the report.</p>

2.2. Test Setup

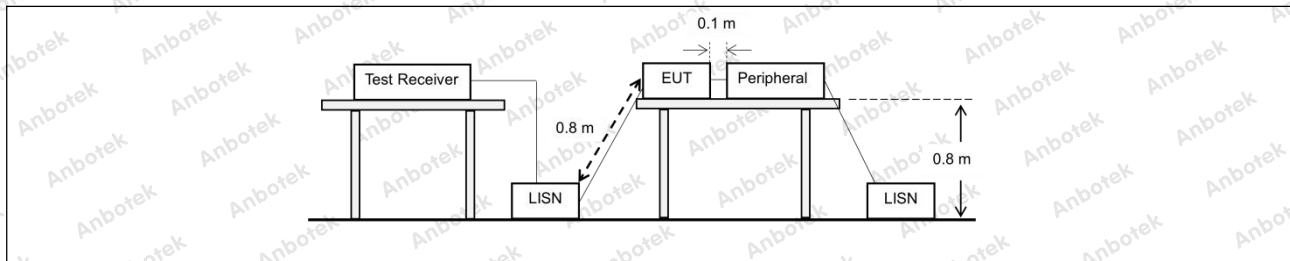

2.3. Test Data

Temperature:	24.5 °C	Humidity:	56%	Atmospheric Pressure:	101 kPa
--------------	---------	-----------	-----	-----------------------	---------

TM1 / Line: Line / Band: 5470-5725 MHz / BW: 20 / CH: H

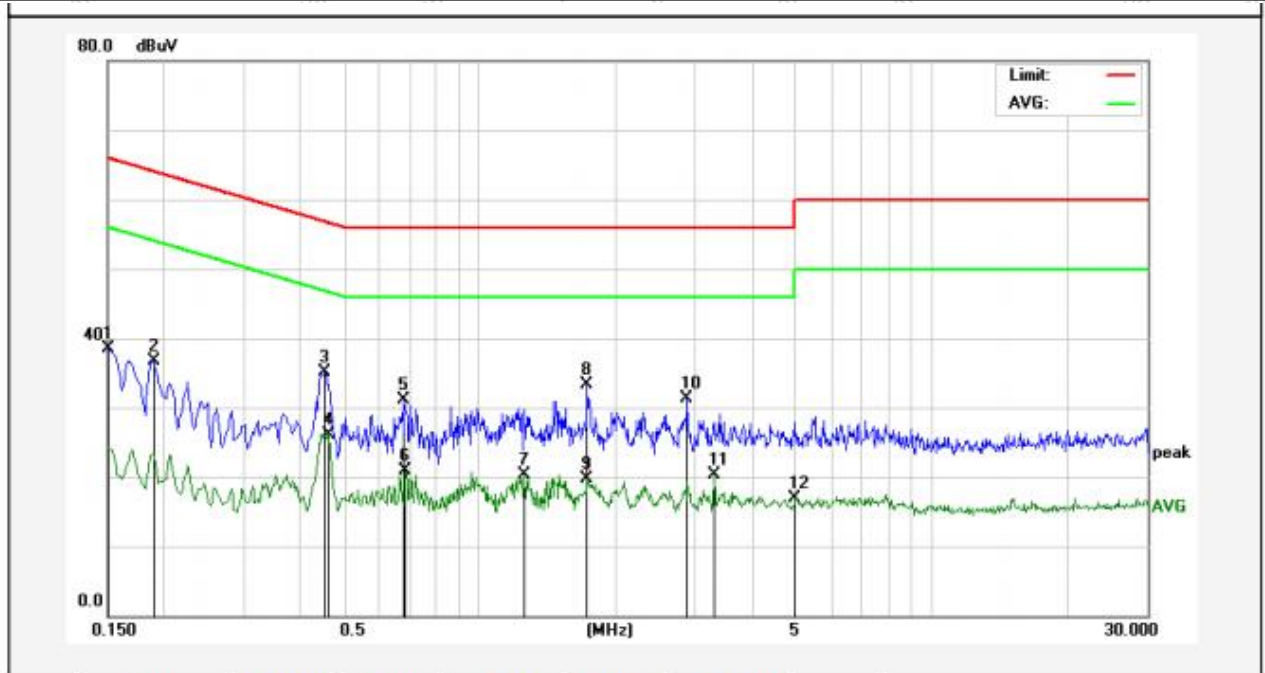

No.	Freq. (MHz)	Reading (dBuV)	Factor (dB)	Result (dBuV)	Limit (dBuV)	Over Limit (dB)	Detector	Remark
1	0.1500	19.49	18.96	38.45	65.99	-27.54	QP	
2	0.1900	17.65	18.99	36.64	64.03	-27.39	QP	
3	0.4540	16.04	19.07	35.11	56.80	-21.69	QP	
4	0.4620	6.98	19.07	26.05	46.66	-20.61	AVG	
5	0.6820	12.14	19.04	31.18	56.00	-24.82	QP	
6	0.6860	1.84	19.04	20.88	46.00	-25.12	AVG	
7	1.2579	1.32	18.93	20.25	46.00	-25.75	AVG	
8	1.7260	14.42	18.90	33.32	56.00	-22.68	QP	
9	1.7260	0.90	18.90	19.80	46.00	-26.20	AVG	
10	2.8780	12.54	18.86	31.40	56.00	-24.60	QP	
11	3.3020	1.49	18.86	20.35	46.00	-25.65	AVG	
12	4.9899	-1.85	18.80	16.95	46.00	-29.05	AVG	

Shenzhen Anbotek Compliance Laboratory Limited

Address: 1/F., Building D, Sogood Science and Technology Park, Sanwei Community, Hangcheng Street, Bao'an District, Shenzhen, Guangdong, China.
 Tel: (86)0755-26066440 Fax: (86)0755-26014772 Email: service@anbotek.com



Hotline
 400-003-0500
 www.anbotek.com.cn



Temperature:	24.5 °C	Humidity:	56%	Atmospheric Pressure:	101 kPa
--------------	---------	-----------	-----	-----------------------	---------

TM1 / Line: Neutral / Band: 5470-5725 MHz / BW: 20 / CH: H

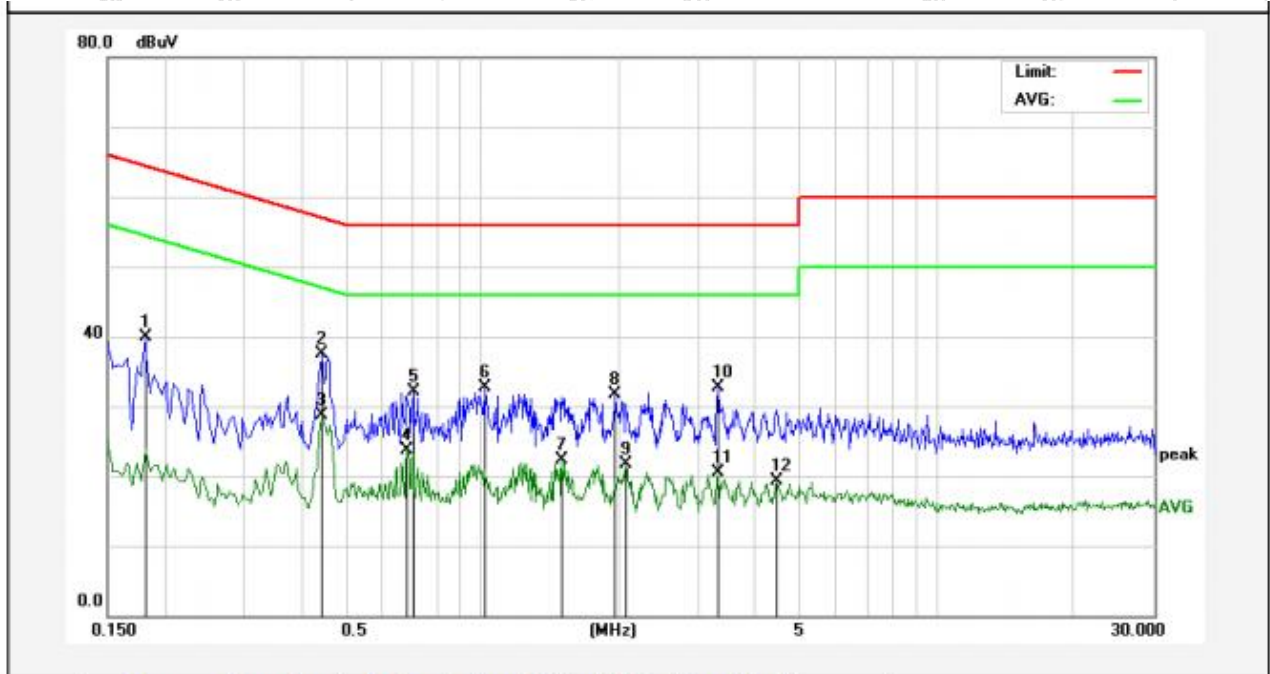

No.	Freq. (MHz)	Reading (dBuV)	Factor (dB)	Result (dBuV)	Limit (dBuV)	Over Limit (dB)	Detector	Remark
1	0.1819	20.85	18.99	39.84	64.39	-24.55	QP	
2	0.4460	18.35	19.06	37.41	56.95	-19.54	QP	
3	0.4460	9.61	19.06	28.67	46.95	-18.28	AVG	
4	0.6860	4.73	19.04	23.77	46.00	-22.23	AVG	
5	0.7060	13.02	19.03	32.05	56.00	-23.95	QP	
6	1.0140	13.69	18.95	32.64	56.00	-23.36	QP	
7	1.5020	3.48	18.90	22.38	46.00	-23.62	AVG	
8	1.9660	12.76	18.88	31.64	56.00	-24.36	QP	
9	2.0740	2.87	18.88	21.75	46.00	-24.25	AVG	
10	3.2980	13.81	18.86	32.67	56.00	-23.33	QP	
11	3.2980	1.59	18.86	20.45	46.00	-25.55	AVG	
12	4.4460	0.42	18.82	19.24	46.00	-26.76	AVG	

Note: Only record the worst data 802.11a in the report.

Shenzhen Anbotek Compliance Laboratory Limited

Address: 1/F., Building D, Sogood Science and Technology Park, Sanwei Community, Hangcheng Street, Bao'an District, Shenzhen, Guangdong, China.
 Tel: (86)0755-26066440 Fax: (86)0755-26014772 Email: service@anbotek.com

Hotline
 400-003-0500
 www.anbotek.com.cn



3. Duty Cycle

Test Requirement:	All measurements are to be performed with the EUT transmitting at 100% duty cycle at its maximum power control level; however, if 100% duty cycle cannot be achieved, measurements of duty cycle, x, and maximum-power transmission duration, T, are required for each tested mode of operation.
Test Limit:	No limits, only for report use.
Test Method:	ANSI C63.10-2020 section 12.2 (b)
Procedure:	<ul style="list-style-type: none"> i) Set the center frequency of the instrument to the center frequency of the transmission. ii) Set RBW \geq EBW if possible; otherwise, set RBW to the largest available value. iii) Set VBW \geq RBW. iv) Set detector = peak. v) The zero-span measurement method shall not be used unless both RBW and VBW are $> 50/T$, where T is defined in item a1) of 12.2, and the number of sweep points across duration T exceeds 100.

3.1. EUT Operation

Operating Environment:	
Test mode:	<ul style="list-style-type: none"> 1: 802.11a mode: Keep the EUT connect to AC power line and works in continuously transmitting mode with 802.11a modulation type. All data rates has been tested and found the data rate @ 6Mbps is the worst case. Only the data of worst case is recorded in the report. 2: 802.11n mode: Keep the EUT connect to AC power line and works in continuously transmitting mode with 802.11n modulation type. All bandwidth and data rates has been tested and found the data rate @ MCS0 is the worst case. Only the data of worst case is recorded in the report.

3.2. Test Setup

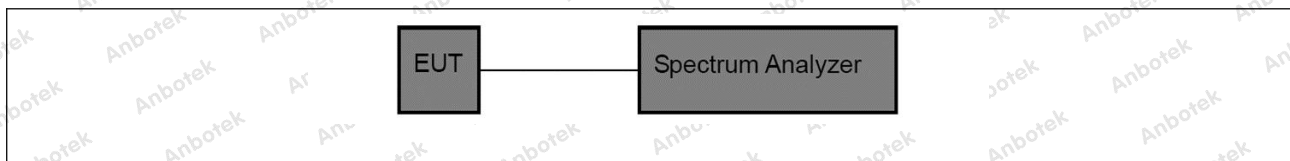

3.3. Test Data

Temperature:	24.9 °C	Humidity:	44 %	Atmospheric Pressure:	101 kPa
--------------	---------	-----------	------	-----------------------	---------

Please refer to Appendix B of the Appendix Test Data.



4. Maximum conducted output power

Test Requirement:	47 CFR Part 15.407(a)(1)(iv) 47 CFR Part 15.407(a)(2) 47 CFR Part 15.407(a)(3)(i)
Test Limit:	<p>For client devices in the 5.15-5.25 GHz band, the maximum conducted output power over the frequency band of operation shall not exceed 250 mW provided the maximum antenna gain does not exceed 6 dBi. If transmitting antennas of directional gain greater than 6 dBi are used, the maximum conducted output power shall be reduced by the amount in dB that the directional gain of the antenna exceeds 6 dBi.</p> <p>For the 5.25-5.35 GHz and 5.47-5.725 GHz bands, the maximum conducted output power over the frequency bands of operation shall not exceed the lesser of 250 mW or 11 dBm + 10 log B, where B is the 26 dB emission bandwidth in megahertz. If transmitting antennas of directional gain greater than 6 dBi are used, the maximum conducted output power shall be reduced by the amount in dB that the directional gain of the antenna exceeds 6 dBi.</p> <p>For the band 5.725-5.850 GHz, the maximum conducted output power over the frequency band of operation shall not exceed 1 W. If transmitting antennas of directional gain greater than 6 dBi are used, the maximum conducted output power shall be reduced by the amount in dB that the directional gain of the antenna exceeds 6 dBi. However, fixed point-to-point U-NII devices operating in this band may employ transmitting antennas with directional gain greater than 6 dBi without any corresponding reduction in transmitter conducted power. Fixed, point-to-point operations exclude the use of point-to-multipoint systems, omnidirectional applications, and multiple collocated transmitters transmitting the same information. The operator of the U-NII device, or if the equipment is professionally installed, the installer, is responsible for ensuring that systems employing high gain directional antennas are used exclusively for fixed, point-to-point operations.</p>
Test Method:	ANSI C63.10-2013, section 12.4
Procedure:	Refer to ANSI C63.10-2020 section 12.4

4.1. EUT Operation

Operating Environment:	
Test mode:	<p>1: 802.11a mode: Keep the EUT connect to AC power line and works in continuously transmitting mode with 802.11a modulation type. All data rates has been tested and found the data rate @ 6Mbps is the worst case. Only the data of worst case is recorded in the report.</p> <p>2: 802.11n mode: Keep the EUT connect to AC power line and works in continuously transmitting mode with 802.11n modulation type. All bandwidth and data rates has been tested and found the data rate @ MCS0 is the worst case. Only the data of worst case is recorded in the report.</p>



4.2. Test Setup

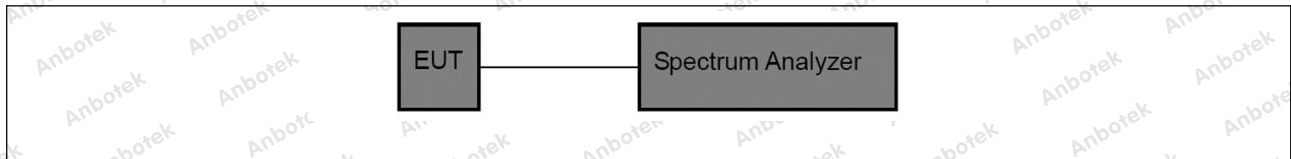

4.3. Test Data

Temperature:	24.9 °C	Humidity:	44 %	Atmospheric Pressure:	101 kPa
--------------	---------	-----------	------	-----------------------	---------

Please refer to Appendix C of the Appendix Test Data.



5. Power spectral density

Test Requirement:	47 CFR Part 15.407(a)(1)(iv) 47 CFR Part 15.407(a)(2) 47 CFR Part 15.407(a)(3)(i)
Test Limit:	<p>For client devices in the 5.15-5.25 GHz band, the maximum power spectral density shall not exceed 11 dBm in any 1 megahertz band. If transmitting antennas of directional gain greater than 6 dBi are used, the maximum power spectral density shall be reduced by the amount in dB that the directional gain of the antenna exceeds 6 dBi.</p> <p>For the 5.25-5.35 GHz and 5.47-5.725 GHz bands, the maximum power spectral density shall not exceed 11 dBm in any 1 megahertz band. If transmitting antennas of directional gain greater than 6 dBi are used, the maximum power spectral density shall be reduced by the amount in dB that the directional gain of the antenna exceeds 6 dBi.</p> <p>For the band 5.725-5.850 GHz, the maximum power spectral density shall not exceed 30 dBm in any 500-kHz band. If transmitting antennas of directional gain greater than 6 dBi are used, the maximum power spectral density shall be reduced by the amount in dB that the directional gain of the antenna exceeds 6 dBi. However, fixed point-to-point U-NII devices operating in this band may employ transmitting antennas with directional gain greater than 6 dBi without any corresponding reduction in transmitter conducted power.</p> <p>Fixed, point-to-point operations exclude the use of point-to-multipoint systems, omnidirectional applications, and multiple collocated transmitters transmitting the same information. The operator of the U-NII device, or if the equipment is professionally installed, the installer, is responsible for ensuring that systems employing high gain directional antennas are used exclusively for fixed, point-to-point operations.</p>
Test Method:	ANSI C63.10-2020, section 12.6
Procedure:	Refer to ANSI C63.10-2020, section 12.6

5.1. EUT Operation

Operating Environment:	
Test mode:	<p>1: 802.11a mode: Keep the EUT connect to AC power line and works in continuously transmitting mode with 802.11a modulation type. All data rates has been tested and found the data rate @ 6Mbps is the worst case. Only the data of worst case is recorded in the report.</p> <p>2: 802.11n mode: Keep the EUT connect to AC power line and works in continuously transmitting mode with 802.11n modulation type. All bandwidth and data rates has been tested and found the data rate @ MCS0 is the worst case. Only the data of worst case is recorded in the report.</p>



5.2. Test Setup

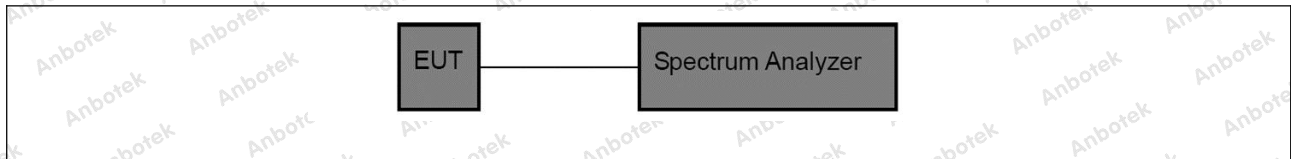

5.3. Test Data

Temperature:	24.9 °C	Humidity:	44 %	Atmospheric Pressure:	101 kPa
--------------	---------	-----------	------	-----------------------	---------

Please refer to Appendix D of the Appendix Test Data.



6. Emission bandwidth and occupied bandwidth

Test Requirement:	U-NII 1, U-NII 2A, U-NII 2C: No limits, only for report use. U-NII 3, U-NII 4: 47 CFR Part 15.407(e)
Test Limit:	U-NII 1, U-NII 2A, U-NII 2C: No limits, only for report use. U-NII 3, U-NII 4: Within the 5.725-5.850 GHz and 5.850-5.895 GHz bands, the minimum 6 dB bandwidth of U-NII devices shall be at least 500 kHz.
Test Method:	ANSI C63.10-2020, section 6.9 & 12.5 KDB 789033 D02, Clause C.2
Procedure:	<p>Emission bandwidth:</p> <ol style="list-style-type: none"> Set RBW = approximately 1% of the emission bandwidth. Set the VBW > RBW. Detector = peak. Trace mode = max hold. Measure the maximum width of the emission that is 26 dB down from the peak of the emission. Compare this with the RBW setting of the instrument. Readjust RBW and repeat measurement as needed until the RBW/EBW ratio is approximately 1%. <p>Occupied bandwidth:</p> <ol style="list-style-type: none"> The instrument center frequency is set to the nominal EUT channel center frequency. The frequency span for the spectrum analyzer shall be between 1.5 times and 5.0 times the OBW. The nominal IF filter bandwidth (3 dB RBW) shall be in the range of 1% to 5% of the OBW, and VBW shall be approximately three times the RBW, unless otherwise specified by the applicable requirement. Set the reference level of the instrument as required, keeping the signal from exceeding the maximum input mixer level for linear operation. In general, the peak of the spectral envelope shall be more than $[10 \log (OBW/RBW)]$ below the reference level. Specific guidance is given in 4.1.5.2. Step a) through step c) might require iteration to adjust within the specified range. Video averaging is not permitted. Where practical, a sample detection and single sweep mode shall be used. Otherwise, peak detection and max hold mode (until the trace stabilizes) shall be used. Use the 99% power bandwidth function of the instrument (if available) and report the measured bandwidth. If the instrument does not have a 99% power bandwidth function, then the trace data points are



	<p>recovered and directly summed in linear power terms. The recovered amplitude data points, beginning at the lowest frequency, are placed in a running sum until 0.5% of the total is reached; that frequency is recorded as the lower frequency. The process is repeated until 99.5% of the total is reached; that frequency is recorded as the upper frequency. The 99% power bandwidth is the difference between these two frequencies.</p> <p>h) The occupied bandwidth shall be reported by providing plot(s) of the measuring instrument display; the plot axes and the scale units per division shall be clearly labeled. Tabular data may be reported in addition to the plot(s).</p> <p>6 dB emission bandwidth:</p> <ol style="list-style-type: none"> Set RBW = 100 kHz. Set the video bandwidth (VBW) $\geq 3 \times$ RBW. Detector = Peak. Trace mode = max hold. Sweep = auto couple. Allow the trace to stabilize. Measure the maximum width of the emission that is constrained by the frequencies associated with the two outermost amplitude points (upper and lower frequencies) that are attenuated by 6 dB relative to the maximum level measured in the fundamental emission.
--	--

6.1. EUT Operation

Operating Environment:	
Test mode:	<ol style="list-style-type: none"> 802.11a mode: Keep the EUT connect to AC power line and works in continuously transmitting mode with 802.11a modulation type. All data rates has been tested and found the data rate @ 6Mbps is the worst case. Only the data of worst case is recorded in the report. 802.11n mode: Keep the EUT connect to AC power line and works in continuously transmitting mode with 802.11n modulation type. All bandwidth and data rates has been tested and found the data rate @ MCS0 is the worst case. Only the data of worst case is recorded in the report.

6.2. Test Setup

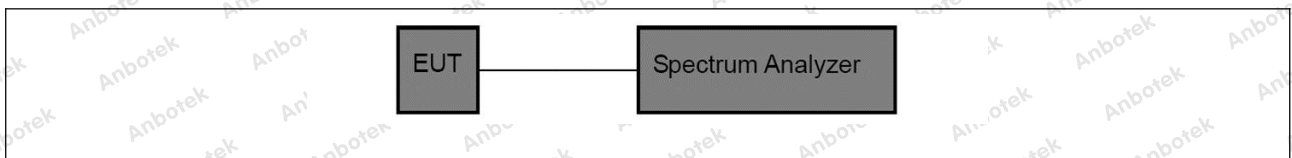

6.3. Test Data

Temperature:	24.9 °C	Humidity:	44 %	Atmospheric Pressure:	101 kPa
--------------	---------	-----------	------	-----------------------	---------

Please refer to Appendix A1&A2&A3 of the Appendix Test Data.

Shenzhen Anbotek Compliance Laboratory Limited

Address: 1/F., Building D, Sogood Science and Technology Park, Sanwei Community, Hangcheng Street, Bao'an District, Shenzhen, Guangdong, China.
Tel: (86)0755-26066440 Fax: (86)0755-26014772 Email: service@anbotek.com



Hotline
400-003-0500
www.anbotek.com.cn



7. Channel Move Time, Channel Closing Transmission Time

Test Requirement:	47 CFR Part 15.407(h)(2)(iii)
Test Limit:	Channel Move Time: within 10 seconds Channel Closing Transmission Time: 200 milliseconds + an aggregate of 60 milliseconds over remaining 10 second period. (The Channel Closing Transmission Time is comprised of 200 milliseconds starting at the beginning of the Channel Move Time plus any additional intermittent control signals required to facilitate a Channel move (an aggregate of 60 milliseconds) during the remainder of the 10 second period. The aggregate duration of control signals will not count quiet periods in between transmissions.)
Test Method:	KDB 905462 D02, Clause 7.8.3
Procedure:	<p>The steps below define the procedure to determine the above-mentioned parameters when a radar <i>Burst</i> with a level equal to the <i>DFS Detection Threshold</i> + 1dB is generated on the <i>Operating Channel</i> of the U-NII device (<i>In-Service Monitoring</i>).</p> <ol style="list-style-type: none"> One frequency will be chosen from the <i>Operating Channels</i> of the UUT within the 5250-5350 MHz or 5470-5725 MHz bands. For 802.11 devices, the test frequency must contain control signals. This can be verified by disabling channel loading and monitoring the spectrum analyzer. If no control signals are detected, another frequency must be selected within the emission bandwidth where control signals are detected. In case the UUT is a U-NII device operating as a <i>Client Device</i> (with or without DFS), a U-NII device operating as a <i>Master Device</i> will be used to allow the UUT (Client device) to <i>Associate</i> with the <i>Master Device</i>. In case the UUT is a <i>Master Device</i>, a U-NII device operating as a <i>Client Device</i> will be used and it is assumed that the Client will <i>Associate</i> with the UUT (Master). In both cases for conducted tests, the <i>Radar Waveform</i> generator will be connected to the <i>Master Device</i>. For radiated tests, the emissions of the <i>Radar Waveform</i> generator will be directed towards the <i>Master Device</i>. If the <i>Master Device</i> has antenna gain, the main beam of the antenna will be directed toward the radar emitter. Vertical polarization is used for testing. Stream the channel loading test file from the <i>Master Device</i> to the <i>Client Device</i> on the test <i>Channel</i> for the entire period of the test. At time T0 the <i>Radar Waveform</i> generator sends a <i>Burst</i> of pulses for one of the Radar Type 0 in Table 5 at levels defined in Table 3, on the <i>Operating Channel</i>. An additional 1 dB is added to the radar test signal to ensure it is at or above the <i>DFS Detection Threshold</i>, accounting for equipment variations/errors. Observe the transmissions of the UUT at the end of the radar <i>Burst</i> on the <i>Operating Channel</i> for duration greater than 10 seconds. Measure and record the transmissions from the UUT during the observation time (<i>Channel Move Time</i>). Measure and record the <i>Channel Move Time</i> and <i>Channel Closing Transmission Time</i> if radar detection occurs. Figure 17 illustrates <i>Channel Closing Transmission Time</i>. When operating as a <i>Master Device</i>, monitor the UUT for more than 30 minutes following instant T2 to verify that the UUT does not resume any transmissions on this <i>Channel</i>. Perform this test once and record the measurement result. In case the UUT is a U-NII device operating as a <i>Client Device</i> with <i>In-Service Monitoring</i>, perform steps 1 to 6.



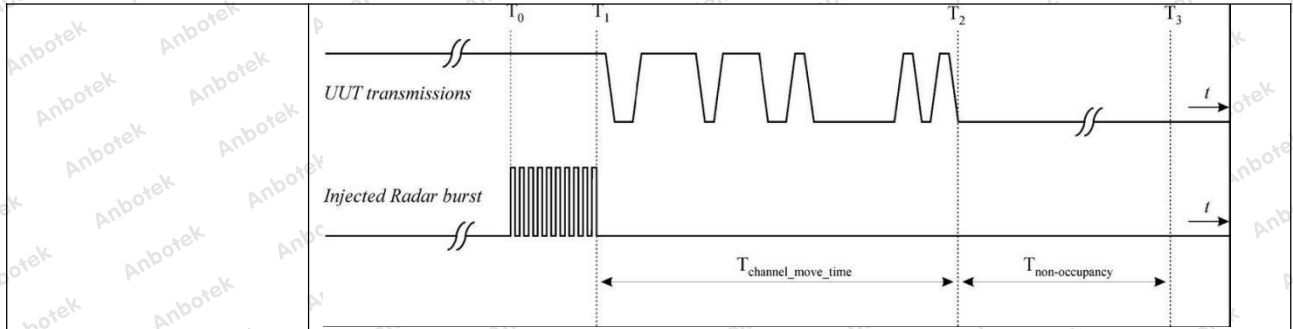

Figure 17: Example of Channel Closing Transmission Time & Channel Closing Time

8. The time for the EUT to fully restart up is 65s.

9. The time for the master device to fully restart up is 65s.

7.1. EUT Operation

Operating Environment:

Test mode: 3: Normal Operating: Keep the EUT works in normal operating mode and connect to companion device

7.2. Test Setup

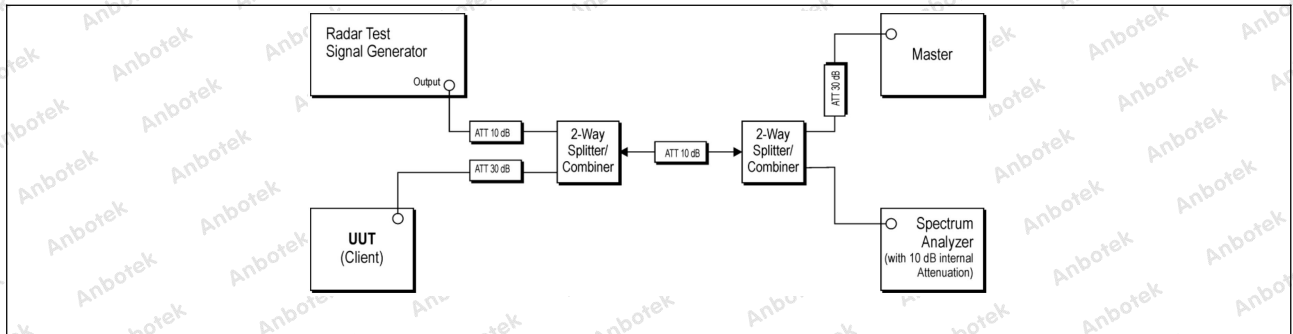

7.3. Test Data

Temperature:	24.9 °C	Humidity:	44 %	Atmospheric Pressure:	101 kPa
--------------	---------	-----------	------	-----------------------	---------

Please refer to Appendix G of the Appendix Test Data.



8. DFS Detection Thresholds

Test Requirement:	KDB 905462 D02, Clause 5.2 Table 3								
Test Limit:	<p>Table 3: DFS Detection Thresholds for Master Devices and Client Devices with Radar Detection</p> <p style="text-align: center;">Table 3: DFS Detection Thresholds for Master Devices and Client Devices with Radar Detection</p> <table border="1"> <thead> <tr> <th>Maximum Transmit Power</th> <th>Value (See Notes 1, 2, and 3)</th> </tr> </thead> <tbody> <tr> <td>EIRP ≥ 200 milliwatt</td> <td>-64 dBm</td> </tr> <tr> <td>EIRP < 200 milliwatt and power spectral density < 10 dBm/MHz</td> <td>-62 dBm</td> </tr> <tr> <td>EIRP < 200 milliwatt that do not meet the power spectral density requirement</td> <td>-64 dBm</td> </tr> </tbody> </table> <p>Note 1: This is the level at the input of the receiver assuming a 0 dBi receive antenna. Note 2: Throughout these test procedures an additional 1 dB has been added to the amplitude of the test transmission waveforms to account for variations in measurement equipment. This will ensure that the test signal is at or above the detection threshold level to trigger a DFS response. Note 3: EIRP is based on the highest antenna gain. For MIMO devices refer to KDB Publication 662911 D01.</p>	Maximum Transmit Power	Value (See Notes 1, 2, and 3)	EIRP ≥ 200 milliwatt	-64 dBm	EIRP < 200 milliwatt and power spectral density < 10 dBm/MHz	-62 dBm	EIRP < 200 milliwatt that do not meet the power spectral density requirement	-64 dBm
Maximum Transmit Power	Value (See Notes 1, 2, and 3)								
EIRP ≥ 200 milliwatt	-64 dBm								
EIRP < 200 milliwatt and power spectral density < 10 dBm/MHz	-62 dBm								
EIRP < 200 milliwatt that do not meet the power spectral density requirement	-64 dBm								
Test Method:	KDB 905462 D02, Clause 7.4.1.1								
Procedure:	<p>1) A 50 ohm load is connected in place of the spectrum analyzer, and the spectrum analyzer is connected to place of the master</p> <p>2) The interference Radar Detection Threshold Level is TH+ 0dBi +1dB that had been taken into account the output power range and antenna gain.</p> <p>3) The following equipment setup was used to calibrate the conducted radar waveform. A vector signal generator was utilized to establish the test signal level for radar type 0. During this process, there were no transmissions by either the master or client device. The spectrum analyzer was switched to the zero spans (time domain) at the frequency of the radar waveform generator. Peak detection was used. The spectrum analyzer resolution bandwidth (RBW) and video bandwidth (VBW) were set to 3 MHz. The spectrum analyzer had offset -1.0dB to compensate RF cable loss 1.0dB.</p> <p>4) The vector signal generator amplitude was set so that the power level measured at the spectrum analyzer was TH + 0dBi +1dB = -63dBm. Capture the spectrum analyzer plots on short pulse radar waveform.</p> <p>Note: TH=-64 dBm or -62 dBm</p>								

8.1. EUT Operation

Operating Environment:	
Test mode:	3: Normal Operating: Keep the EUT works in normal operating mode and connect to companion device



8.2. Test Setup

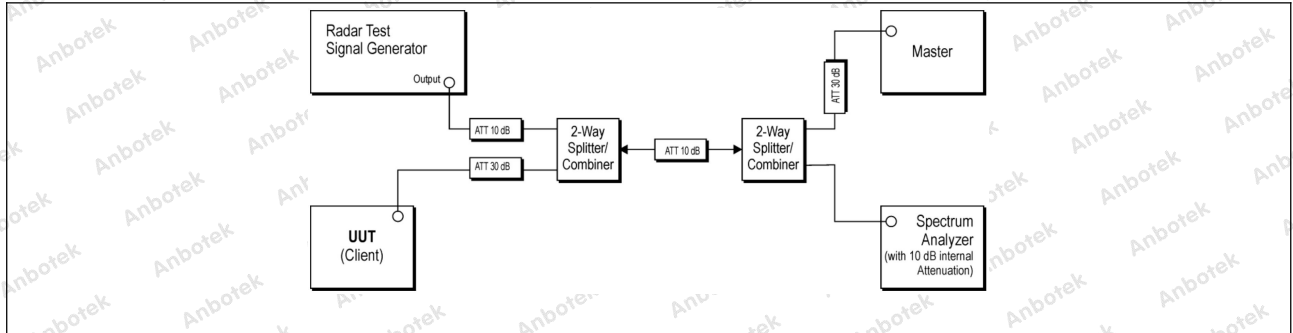

8.3. Test Data

Temperature:	24.9 °C	Humidity:	44 %	Atmospheric Pressure:	101 kPa
--------------	---------	-----------	------	-----------------------	---------

Please refer to Appendix F of the Appendix Test Data.



9. Band edge emissions (Radiated)

Test Requirement:	<p>47 CFR Part 15.407(b)(1) 47 CFR Part 15.407(b)(2) 47 CFR Part 15.407(b)(3) 47 CFR Part 15.407(b)(4) 47 CFR Part 15.407(b)(10)</p>																																																																								
Test Limit:	<p>For transmitters operating in the 5.15-5.25 GHz band: All emissions outside of the 5.15-5.35 GHz band shall not exceed an e.i.r.p. of -27 dBm/MHz.</p> <p>For transmitters operating in the 5.25-5.35 GHz band: All emissions outside of the 5.15-5.35 GHz band shall not exceed an e.i.r.p. of -27 dBm/MHz.</p> <p>For transmitters operating in the 5.47-5.725 GHz band: All emissions outside of the 5.47-5.725 GHz band shall not exceed an e.i.r.p. of -27 dBm/MHz.</p> <p>For transmitters operating solely in the 5.725-5.850 GHz band: All emissions shall be limited to a level of -27 dBm/MHz at 75 MHz or more above or below the band edge increasing linearly to 10 dBm/MHz at 25 MHz above or below the band edge, and from 25 MHz above or below the band edge increasing linearly to a level of 15.6 dBm/MHz at 5 MHz above or below the band edge, and from 5 MHz above or below the band edge increasing linearly to a level of 27 dBm/MHz at the band edge.</p> <table border="1"> <thead> <tr> <th>MHz</th> <th>MHz</th> <th>MHz</th> <th>GHz</th> </tr> </thead> <tbody> <tr> <td>0.090-0.110</td> <td>16.42-16.423</td> <td>399.9-410</td> <td>4.5-5.15</td> </tr> <tr> <td>¹0.495-0.505</td> <td>16.69475-16.69525</td> <td>608-614</td> <td>5.35-5.46</td> </tr> <tr> <td>2.1735-2.1905</td> <td>16.80425-16.80475</td> <td>960-1240</td> <td>7.25-7.75</td> </tr> <tr> <td>4.125-4.128</td> <td>25.5-25.67</td> <td>1300-1427</td> <td>8.025-8.5</td> </tr> <tr> <td>4.17725-4.17775</td> <td>37.5-38.25</td> <td>1435-1626.5</td> <td>9.0-9.2</td> </tr> <tr> <td>4.20725-4.20775</td> <td>73-74.6</td> <td>1645.5-1646.5</td> <td>9.3-9.5</td> </tr> <tr> <td>6.215-6.218</td> <td>74.8-75.2</td> <td>1660-1710</td> <td>10.6-12.7</td> </tr> <tr> <td>6.26775-6.26825</td> <td>108-121.94</td> <td>1718.8-1722.2</td> <td>13.25-13.4</td> </tr> <tr> <td>6.31175-6.31225</td> <td>123-138</td> <td>2200-2300</td> <td>14.47-14.5</td> </tr> <tr> <td>8.291-8.294</td> <td>149.9-150.05</td> <td>2310-2390</td> <td>15.35-16.2</td> </tr> <tr> <td>8.362-8.366</td> <td>156.52475-156.52525</td> <td>2483.5-2500</td> <td>17.7-21.4</td> </tr> <tr> <td>8.37625-8.38675</td> <td>156.7-156.9</td> <td>2690-2900</td> <td>22.01-23.12</td> </tr> <tr> <td>8.41425-8.41475</td> <td>162.0125-167.17</td> <td>3260-3267</td> <td>23.6-24.0</td> </tr> <tr> <td>12.29-12.293</td> <td>167.72-173.2</td> <td>3332-3339</td> <td>31.2-31.8</td> </tr> <tr> <td>12.51975-12.52025</td> <td>240-285</td> <td>3345.8-3358</td> <td>36.43-36.5</td> </tr> <tr> <td>12.57675-12.57725</td> <td>322-335.4</td> <td>3600-4400</td> <td>(²)</td> </tr> <tr> <td>13.36-13.41</td> <td></td> <td></td> <td></td> </tr> </tbody> </table> <p>¹Until February 1, 1999, this restricted band shall be 0.490-0.510 MHz.</p> <p>²Above 38.6</p>	MHz	MHz	MHz	GHz	0.090-0.110	16.42-16.423	399.9-410	4.5-5.15	¹ 0.495-0.505	16.69475-16.69525	608-614	5.35-5.46	2.1735-2.1905	16.80425-16.80475	960-1240	7.25-7.75	4.125-4.128	25.5-25.67	1300-1427	8.025-8.5	4.17725-4.17775	37.5-38.25	1435-1626.5	9.0-9.2	4.20725-4.20775	73-74.6	1645.5-1646.5	9.3-9.5	6.215-6.218	74.8-75.2	1660-1710	10.6-12.7	6.26775-6.26825	108-121.94	1718.8-1722.2	13.25-13.4	6.31175-6.31225	123-138	2200-2300	14.47-14.5	8.291-8.294	149.9-150.05	2310-2390	15.35-16.2	8.362-8.366	156.52475-156.52525	2483.5-2500	17.7-21.4	8.37625-8.38675	156.7-156.9	2690-2900	22.01-23.12	8.41425-8.41475	162.0125-167.17	3260-3267	23.6-24.0	12.29-12.293	167.72-173.2	3332-3339	31.2-31.8	12.51975-12.52025	240-285	3345.8-3358	36.43-36.5	12.57675-12.57725	322-335.4	3600-4400	(²)	13.36-13.41			
MHz	MHz	MHz	GHz																																																																						
0.090-0.110	16.42-16.423	399.9-410	4.5-5.15																																																																						
¹ 0.495-0.505	16.69475-16.69525	608-614	5.35-5.46																																																																						
2.1735-2.1905	16.80425-16.80475	960-1240	7.25-7.75																																																																						
4.125-4.128	25.5-25.67	1300-1427	8.025-8.5																																																																						
4.17725-4.17775	37.5-38.25	1435-1626.5	9.0-9.2																																																																						
4.20725-4.20775	73-74.6	1645.5-1646.5	9.3-9.5																																																																						
6.215-6.218	74.8-75.2	1660-1710	10.6-12.7																																																																						
6.26775-6.26825	108-121.94	1718.8-1722.2	13.25-13.4																																																																						
6.31175-6.31225	123-138	2200-2300	14.47-14.5																																																																						
8.291-8.294	149.9-150.05	2310-2390	15.35-16.2																																																																						
8.362-8.366	156.52475-156.52525	2483.5-2500	17.7-21.4																																																																						
8.37625-8.38675	156.7-156.9	2690-2900	22.01-23.12																																																																						
8.41425-8.41475	162.0125-167.17	3260-3267	23.6-24.0																																																																						
12.29-12.293	167.72-173.2	3332-3339	31.2-31.8																																																																						
12.51975-12.52025	240-285	3345.8-3358	36.43-36.5																																																																						
12.57675-12.57725	322-335.4	3600-4400	(²)																																																																						
13.36-13.41																																																																									



	<p>The field strength of emissions appearing within these frequency bands shall not exceed the limits shown in § 15.209. At frequencies equal to or less than 1000 MHz, compliance with the limits in § 15.209 shall be demonstrated using measurement instrumentation employing a CISPR quasi-peak detector. Above 1000 MHz, compliance with the emission limits in § 15.209 shall be demonstrated based on the average value of the measured emissions. The provisions in § 15.35 apply to these measurements.</p> <p>Except as provided elsewhere in this subpart, the emissions from an intentional radiator shall not exceed the field strength levels specified in the following table:</p> <table border="1" data-bbox="491 672 1433 1003"> <thead> <tr> <th>Frequency (MHz)</th> <th>Field strength (microvolts/meter)</th> <th>Measurement distance (meters)</th> </tr> </thead> <tbody> <tr> <td>0.009-0.490</td> <td>2400/F(kHz)</td> <td>300</td> </tr> <tr> <td>0.490-1.705</td> <td>24000/F(kHz)</td> <td>30</td> </tr> <tr> <td>1.705-30.0</td> <td>30</td> <td>30</td> </tr> <tr> <td>30-88</td> <td>100 **</td> <td>3</td> </tr> <tr> <td>88-216</td> <td>150 **</td> <td>3</td> </tr> <tr> <td>216-960</td> <td>200 **</td> <td>3</td> </tr> <tr> <td>Above 960</td> <td>500</td> <td>3</td> </tr> </tbody> </table> <p>** Except as provided in paragraph (g), fundamental emissions from intentional radiators operating under this section shall not be located in the frequency bands 54-72 MHz, 76-88 MHz, 174-216 MHz or 470-806 MHz. However, operation within these frequency bands is permitted under other sections of this part, e.g., §§ 15.231 and 15.241. In the emission table above, the tighter limit applies at the band edges. The emission limits shown in the above table are based on measurements employing a CISPR quasi-peak detector except for the frequency bands 9–90 kHz, 110–490 kHz and above 1000 MHz. Radiated emission limits in these three bands are based on measurements employing an average detector.</p>	Frequency (MHz)	Field strength (microvolts/meter)	Measurement distance (meters)	0.009-0.490	2400/F(kHz)	300	0.490-1.705	24000/F(kHz)	30	1.705-30.0	30	30	30-88	100 **	3	88-216	150 **	3	216-960	200 **	3	Above 960	500	3
Frequency (MHz)	Field strength (microvolts/meter)	Measurement distance (meters)																							
0.009-0.490	2400/F(kHz)	300																							
0.490-1.705	24000/F(kHz)	30																							
1.705-30.0	30	30																							
30-88	100 **	3																							
88-216	150 **	3																							
216-960	200 **	3																							
Above 960	500	3																							
<p>Test Method:</p>	<p>ANSI C63.10-2020, section 12.7.4, 12.7.6, 12.7.7</p>																								
<p>Procedure:</p>	<p>Above 1GHz:</p> <ol style="list-style-type: none"> For above 1GHz, the EUT was placed on the top of a rotating table 1.5 meters above the ground at a 3 meter fully-anechoic chamber. The table was rotated 360 degrees to determine the position of the highest radiation. The EUT was set 3 meters away from the interference-receiving antenna, which was mounted on the top of a variable-height antenna tower. The antenna height is varied from one meter to four meters above the ground to determine the maximum value of the field strength. Both horizontal and vertical polarizations of the antenna are set to make the measurement. For each suspected emission, the EUT was arranged to its worst case and then the antenna was tuned to heights from 1 meter to 4 meters (for the test frequency of below 30MHz, the antenna was tuned to heights 1 meter) and the rotatable table was turned from 0 degrees to 360 degrees to find the maximum reading. The test-receiver system was set to Peak Detect Function and Specified Bandwidth with Maximum Hold Mode. If the emission level of the EUT in peak mode was 10dB lower than the limit specified, then testing could be stopped and the peak values of the EUT 																								



	<p>would be reported. Otherwise the emissions that did not have 10dB margin would be re-tested one by one using peak or average method as specified and then reported in a data sheet.</p> <p>g. Test the EUT in the lowest channel, the middle channel, the Highest channel.</p> <p>h. The radiation measurements are performed in X, Y, Z axis positioning for Transmitting mode, and found the X axis positioning which it is the worst case.</p> <p>i. Repeat above procedures until all frequencies measured was complete.</p> <p>Remark:</p> <ol style="list-style-type: none"> 1. Level= Read Level+ Cable Loss+ Antenna Factor- Preamp Factor 2. Scan from 18GHz to 40GHz, the disturbance above 18GHz was very low. The points marked on above plots are the highest emissions could be found when testing, so only above points had been displayed. The amplitude of spurious emissions from the radiator which are attenuated more than 20dB below the limit need not be reported. 3. As shown in this section, for frequencies above 1GHz, the field strength limits are based on average limits. However, the peak field strength of any emission shall not exceed the maximum permitted average limits specified above by more than 20 dB under any condition of modulation. For the emissions whose peak level is lower than the average limit, only the peak measurement is shown in the report. 4. The disturbance above 18GHz were very low and the harmonics were the highest point could be found when testing, so only the above harmonics had been displayed.
--	---

9.1. EUT Operation

Operating Environment:	
Test mode:	<p>1: 802.11a mode: Keep the EUT connect to AC power line and works in continuously transmitting mode with 802.11a modulation type. All data rates has been tested and found the data rate @ 6Mbps is the worst case. Only the data of worst case is recorded in the report.</p> <p>2: 802.11n mode: Keep the EUT connect to AC power line and works in continuously transmitting mode with 802.11n modulation type. All bandwidth and data rates has been tested and found the data rate @ MCS0 is the worst case. Only the data of worst case is recorded in the report.</p>

9.2. Test Setup

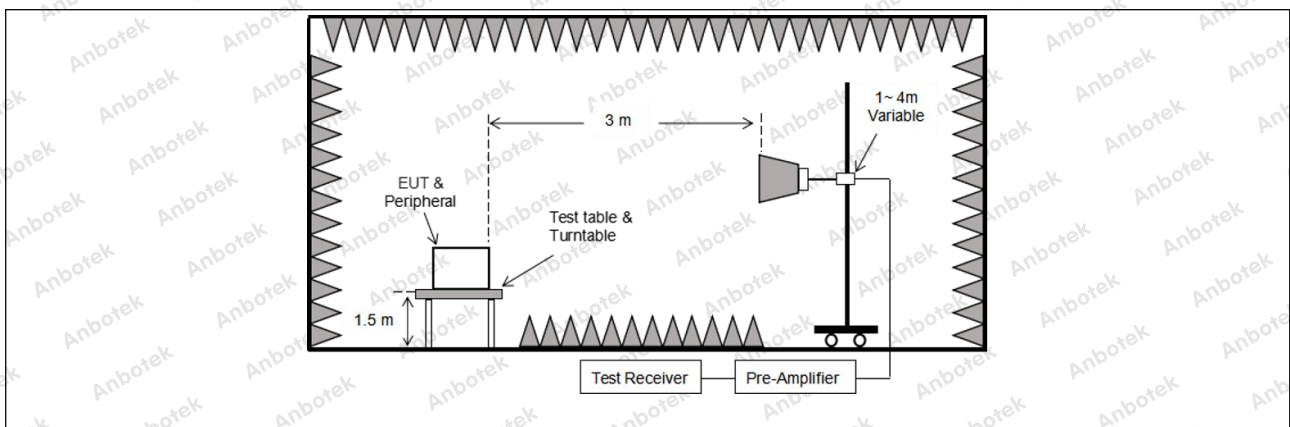

9.3. Test Data

Temperature:	24.9 °C	Humidity:	44 %	Atmospheric Pressure:	101 kPa
--------------	---------	-----------	------	-----------------------	---------

TM1 / Band: 5150-5350 MHz / BW: 20 / L							
Frequency (MHz)	Reading (dBuV)	Factor (dB/m)	Result (dBuV/m)	Limit (dBuV/m)	Over limit (dB)	Antenna Pol.	Detector
5150.00	36.97	15.99	52.96	68.20	-15.24	H	Peak
5150.00	39.04	15.99	55.03	68.20	-13.17	V	Peak
5150.00	26.91	15.99	42.90	54.00	-11.10	H	AVG
5150.00	28.96	15.99	44.95	54.00	-9.05	V	AVG
TM1 / Band: 5150-5350 MHz / BW: 20 / H							
Frequency (MHz)	Reading (dBuV)	Factor (dB/m)	Result (dBuV/m)	Limit (dBuV/m)	Over limit (dB)	Antenna Pol.	Detector
5350.00	37.42	16.43	53.85	68.20	-14.35	H	Peak
5350.00	40.36	16.43	56.79	68.20	-11.41	V	Peak
5350.00	28.74	16.43	45.17	54.00	-8.83	H	AVG
5350.00	29.64	16.43	46.07	54.00	-7.93	V	AVG

Remark: 1. Result=Reading + Factor

TM2 / Band: 5150-5350 MHz / BW: 20 / L							
Frequency (MHz)	Reading (dBuV)	Factor (dB/m)	Result (dBuV/m)	Limit (dBuV/m)	Over limit (dB)	Antenna Pol.	Detector
5150.00	35.92	15.99	51.91	68.20	-16.29	H	Peak
5150.00	37.31	15.99	53.30	68.20	-14.90	V	Peak
5150.00	26.64	15.99	42.63	54.00	-11.37	H	AVG
5150.00	27.63	15.99	43.62	54.00	-10.38	V	AVG
TM2 / Band: 5150-5350 MHz / BW: 20 / H							
Frequency (MHz)	Reading (dBuV)	Factor (dB/m)	Result (dBuV/m)	Limit (dBuV/m)	Over limit (dB)	Antenna Pol.	Detector
5350.00	37.74	16.43	54.17	68.20	-14.03	H	Peak
5350.00	38.78	16.43	55.21	68.20	-12.99	V	Peak
5350.00	27.77	16.43	44.20	54.00	-9.80	H	AVG
5350.00	29.22	16.43	45.65	54.00	-8.35	V	AVG

Remark: 1. Result=Reading + Factor



TM1 / Band: 5470-5850 MHz / BW: 20 / L							
Frequency (MHz)	Reading (dBuV)	Factor (dB/m)	Result (dBuV/m)	Limit (dBuV/m)	Over limit (dB)	Antenna Pol.	Detector
5460.00	38.16	16.37	54.53	68.20	-13.67	H	Peak
5460.00	39.54	16.37	55.91	68.20	-12.29	V	Peak
5470.00	39.09	16.70	55.79	68.20	-12.41	H	Peak
5470.00	39.83	16.70	56.53	68.20	-11.67	V	Peak
5460.00	28.76	16.37	45.13	54.00	-8.87	H	AVG
5460.00	28.63	16.37	45.00	54.00	-9.00	V	AVG
5470.00	29.03	16.70	45.73	54.00	-8.27	H	AVG
5470.00	30.14	16.70	46.84	54.00	-7.16	V	AVG
TM1 / Band: 5470-5850 MHz / BW: 20 / H							
Frequency (MHz)	Reading (dBuV)	Factor (dB/m)	Result (dBuV/m)	Limit (dBuV/m)	Over limit (dB)	Antenna Pol.	Detector
5850.00	39.11	17.21	56.32	68.20	-11.88	H	Peak
5850.00	39.47	17.21	56.68	68.20	-11.52	V	Peak
5850.00	29.09	17.21	46.30	54.00	-7.70	H	AVG
5850.00	29.11	17.21	46.32	54.00	-7.68	V	AVG

Remark: 1. Result=Reading + Factor

TM2 / Band: 5470-5850 MHz / BW: 20 / L							
Frequency (MHz)	Reading (dBuV)	Factor (dB/m)	Result (dBuV/m)	Limit (dBuV/m)	Over limit (dB)	Antenna Pol.	Detector
5460.00	38.14	16.37	54.51	68.20	-13.69	H	Peak
5460.00	38.71	16.37	55.08	68.20	-13.12	V	Peak
5470.00	38.25	16.70	54.95	68.20	-13.25	H	Peak
5470.00	38.66	16.70	55.36	68.20	-12.84	V	Peak
5460.00	27.15	16.37	43.52	54.00	-10.48	H	AVG
5460.00	27.58	16.37	43.95	54.00	-10.05	V	AVG
5470.00	27.59	16.70	44.29	54.00	-9.71	H	AVG
5470.00	28.12	16.70	44.82	54.00	-9.18	V	AVG
TM2 / Band: 5470-5850 MHz / BW: 20 / H							
Frequency (MHz)	Reading (dBuV)	Factor (dB/m)	Result (dBuV/m)	Limit (dBuV/m)	Over limit (dB)	Antenna Pol.	Detector
5850.00	37.35	17.21	54.56	68.20	-13.64	H	Peak
5850.00	37.96	17.21	55.17	68.20	-13.03	V	Peak
5850.00	27.62	17.21	44.83	54.00	-9.17	H	AVG
5850.00	28.45	17.21	45.66	54.00	-8.34	V	AVG

Remark: 1. Result=Reading + Factor

Shenzhen Anbotek Compliance Laboratory Limited

Address: 1/F., Building D, Sogood Science and Technology Park, Sanwei Community, Hangcheng Street, Bao'an District, Shenzhen, Guangdong, China.
 Tel: (86)0755-26066440 Fax: (86)0755-26014772 Email: service@anbotek.com

Hotline 400-003-0500
 www.anbotek.com.cn



10. Band edge emissions (Conducted)

Test Requirement:	47 CFR Part 15.407(b)(1) 47 CFR Part 15.407(b)(2)
Test Limit:	For transmitters operating in the 5.15-5.25 GHz band: All emissions outside of the 5.15-5.35 GHz band shall not exceed an e.i.r.p. of -27 dBm/MHz. For transmitters operating in the 5.25-5.35 GHz band: All emissions outside of the 5.15-5.35 GHz band shall not exceed an e.i.r.p. of -27 dBm/MHz.
Test Method:	Peak emission levels are measured by setting the instrument as follows: RBW = 1 MHz. VBW ≥ [3 × RBW] Detector = peak. Sweep time = auto. Trace mode = max hold.

10.1. EUT Operation

Operating Environment:	
Test mode:	1: 802.11a mode: Keep the EUT in continuously transmitting mode with 802.11a modulation type. All data rates has been tested and found the data rate @ 6Mbps is the worst case. Only the data of worst case is recorded in the report. 2: 802.11n mode: Keep the EUT in continuously transmitting mode with 802.11n modulation type. All bandwidth and data rates has been tested and found the data rate @ MCS0 is the worst case. Only the data of worst case is recorded in the report. 3: 802.11ac mode: Keep the EUT in continuously transmitting mode with 802.11ac modulation type. All bandwidth and data rates has been tested and found the data rate @ MCS0 is the worst case. Only the data of worst case is recorded in the report.

10.2. Test Setup

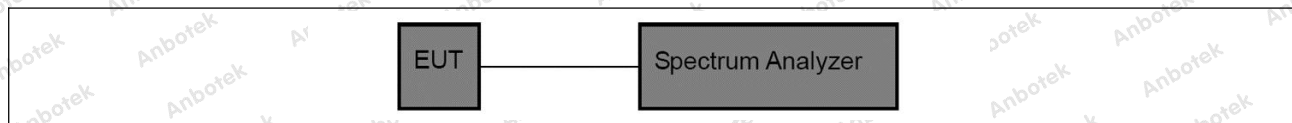

10.3. Test Data

Temperature:	24.9°C	Humidity:	44 %	Atmospheric Pressure:	101 kPa
--------------	--------	-----------	------	-----------------------	---------

Please refer to Appendix E of the Appendix Test Data.



11. Undesirable emission limits (below 1GHz)

Test Requirement:	47 CFR Part 15.407(b)(9)																								
Test Limit:	Unwanted emissions below 1 GHz must comply with the general field strength limits set forth in § 15.209.																								
	Except as provided elsewhere in this subpart, the emissions from an intentional radiator shall not exceed the field strength levels specified in the following table:																								
	<table border="1"> <thead> <tr> <th>Frequency (MHz)</th> <th>Field strength (microvolts/meter)</th> <th>Measurement distance (meters)</th> </tr> </thead> <tbody> <tr> <td>0.009-0.490</td> <td>2400/F(kHz)</td> <td>300</td> </tr> <tr> <td>0.490-1.705</td> <td>24000/F(kHz)</td> <td>30</td> </tr> <tr> <td>1.705-30.0</td> <td>30</td> <td>30</td> </tr> <tr> <td>30-88</td> <td>100 **</td> <td>3</td> </tr> <tr> <td>88-216</td> <td>150 **</td> <td>3</td> </tr> <tr> <td>216-960</td> <td>200 **</td> <td>3</td> </tr> <tr> <td>Above 960</td> <td>500</td> <td>3</td> </tr> </tbody> </table>	Frequency (MHz)	Field strength (microvolts/meter)	Measurement distance (meters)	0.009-0.490	2400/F(kHz)	300	0.490-1.705	24000/F(kHz)	30	1.705-30.0	30	30	30-88	100 **	3	88-216	150 **	3	216-960	200 **	3	Above 960	500	3
	Frequency (MHz)	Field strength (microvolts/meter)	Measurement distance (meters)																						
	0.009-0.490	2400/F(kHz)	300																						
	0.490-1.705	24000/F(kHz)	30																						
	1.705-30.0	30	30																						
	30-88	100 **	3																						
	88-216	150 **	3																						
	216-960	200 **	3																						
Above 960	500	3																							
** Except as provided in paragraph (g), fundamental emissions from intentional radiators operating under this section shall not be located in the frequency bands 54-72 MHz, 76-88 MHz, 174-216 MHz or 470-806 MHz. However, operation within these frequency bands is permitted under other sections of this part, e.g., §§ 15.231 and 15.241.																									
In the emission table above, the tighter limit applies at the band edges.																									
The emission limits shown in the above table are based on measurements employing a CISPR quasi-peak detector except for the frequency bands 9–90 kHz, 110–490 kHz and above 1000 MHz. Radiated emission limits in these three bands are based on measurements employing an average detector.																									
Test Method:	ANSI C63.10-2020, section 12.7.4, 12.7.5																								
Procedure:	<p>Below 1GHz:</p> <p>a. For below 1GHz, the EUT was placed on the top of a rotating table 0.8 meters above the ground at a 3 meter semi-anechoic chamber. The table was rotated 360 degrees to determine the position of the highest radiation.</p> <p>b. The EUT was set 3 or 10 meters away from the interference-receiving antenna, which was mounted on the top of a variable-height antenna tower.</p> <p>c. The antenna height is varied from one meter to four meters above the ground to determine the maximum value of the field strength. Both horizontal and vertical polarizations of the antenna are set to make the measurement.</p> <p>d. For each suspected emission, the EUT was arranged to its worst case and then the antenna was tuned to heights from 1 meter to 4 meters (for the test frequency of below 30MHz, the antenna was tuned to heights 1 meter) and the rotatable table was turned from 0 degrees to 360 degrees to find the maximum reading.</p> <p>e. The test-receiver system was set to Peak Detect Function and Specified Bandwidth with Maximum Hold Mode.</p> <p>f. If the emission level of the EUT in peak mode was 10dB lower than the limit specified, then testing could be stopped and the peak values of the EUT would be reported. Otherwise the emissions that did not have 10dB margin</p>																								



would be re-tested one by one using quasi-peak method as specified and then reported in a data sheet.

g. Test the EUT in the lowest channel, the middle channel, the Highest channel.

h. The radiation measurements are performed in X, Y, Z axis positioning for Transmitting mode, and found the X axis positioning which it is the worst case.

i. Repeat above procedures until all frequencies measured was complete.

Remark:

1. Level= Read Level+ Cable Loss+ Antenna Factor- Preamp Factor

2. Scan from 9kHz to 30MHz, the disturbance below 30MHz was very low.

The points marked on above plots are the highest emissions could be found when testing, so only above points had been displayed. The amplitude of spurious emissions from the radiator which are attenuated more than 20dB below the limit need not be reported.

3. The disturbance below 1GHz was very low and the harmonics were the highest point could be found when testing, so only the above harmonics had been displayed.

Above 1GHz:

a. For above 1GHz, the EUT was placed on the top of a rotating table 1.5 meters above the ground at a 3 meter fully-anechoic chamber. The table was rotated 360 degrees to determine the position of the highest radiation.

b. The EUT was set 3 meters away from the interference-receiving antenna, which was mounted on the top of a variable-height antenna tower.

c. The antenna height is varied from one meter to four meters above the ground to determine the maximum value of the field strength. Both horizontal and vertical polarizations of the antenna are set to make the measurement.

d. For each suspected emission, the EUT was arranged to its worst case and then the antenna was tuned to heights from 1 meter to 4 meters (for the test frequency of below 30MHz, the antenna was tuned to heights 1 meter) and the rotatable table was turned from 0 degrees to 360 degrees to find the maximum reading.

e. The test-receiver system was set to Peak Detect Function and Specified Bandwidth with Maximum Hold Mode.

f. If the emission level of the EUT in peak mode was 10dB lower than the limit specified, then testing could be stopped and the peak values of the EUT would be reported. Otherwise the emissions that did not have 10dB margin would be re-tested one by one using peak or average method as specified and then reported in a data sheet.

g. Test the EUT in the lowest channel, the middle channel, the Highest channel.

h. The radiation measurements are performed in X, Y, Z axis positioning for Transmitting mode, and found the X axis positioning which it is the worst case.

i. Repeat above procedures until all frequencies measured was complete.

Remark:

1. Level= Read Level+ Cable Loss+ Antenna Factor- Preamp Factor

2. Scan from 18GHz to 40GHz, the disturbance above 18GHz was very low.

The points marked on above plots are the highest emissions could be found when testing, so only above points had been displayed. The amplitude of spurious emissions from the radiator which are attenuated more than 20dB



below the limit need not be reported.

3. As shown in this section, for frequencies above 1GHz, the field strength limits are based on average limits. However, the peak field strength of any emission shall not exceed the maximum permitted average limits specified above by more than 20 dB under any condition of modulation. For the emissions whose peak level is lower than the average limit, only the peak measurement is shown in the report.

4. The disturbance above 18GHz were very low and the harmonics were the highest point could be found when testing, so only the above harmonics had been displayed.

11.1. EUT Operation

Operating Environment:

Test mode:

1: 802.11a mode: Keep the EUT connect to AC power line and works in continuously transmitting mode with 802.11a modulation type. All data rates has been tested and found the data rate @ 6Mbps is the worst case. Only the data of worst case is recorded in the report.

2: 802.11n mode: Keep the EUT connect to AC power line and works in continuously transmitting mode with 802.11n modulation type. All bandwidth and data rates has been tested and found the data rate @ MCS0 is the worst case. Only the data of worst case is recorded in the report.

11.2. Test Setup

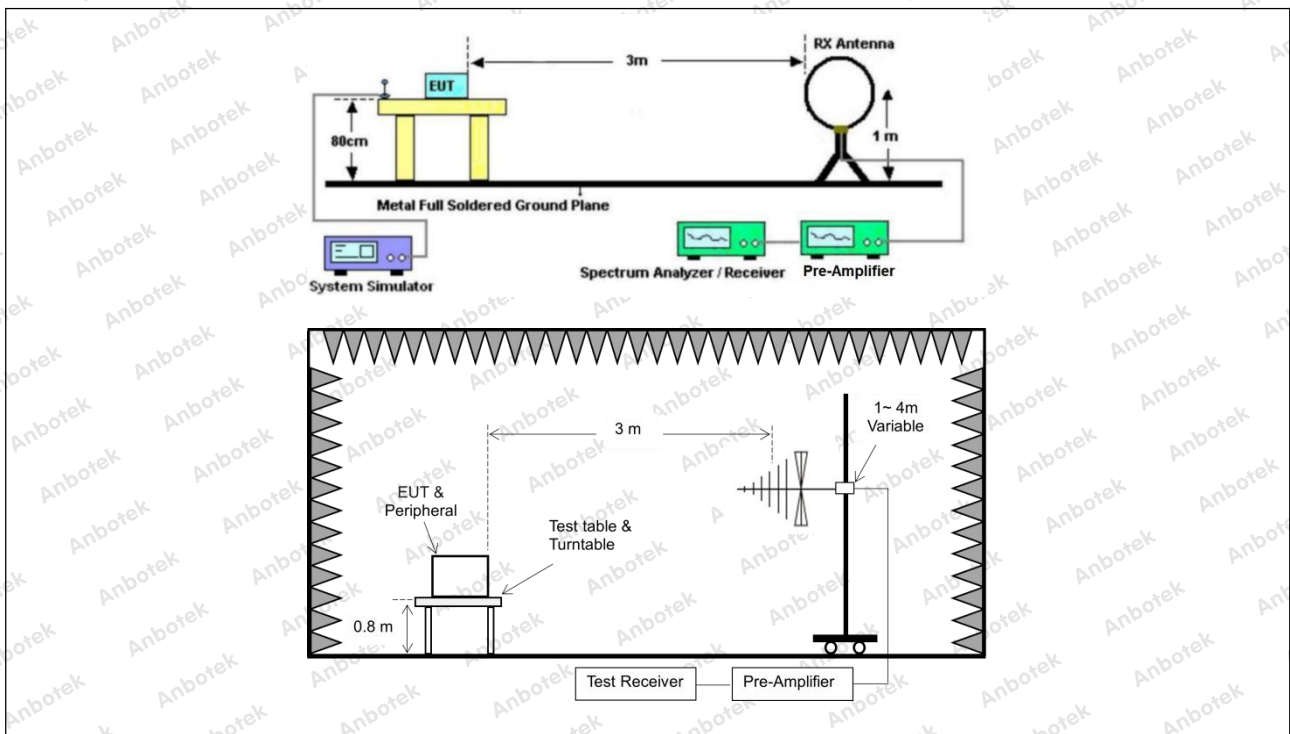

11.3. Test Data

The test results of 9kHz-30MHz was attenuated more than 20dB below the permissible limits, so the results don't record in the report.

Temperature:	24.9 °C	Humidity:	44 %	Atmospheric Pressure:	101 kPa
--------------	---------	-----------	------	-----------------------	---------

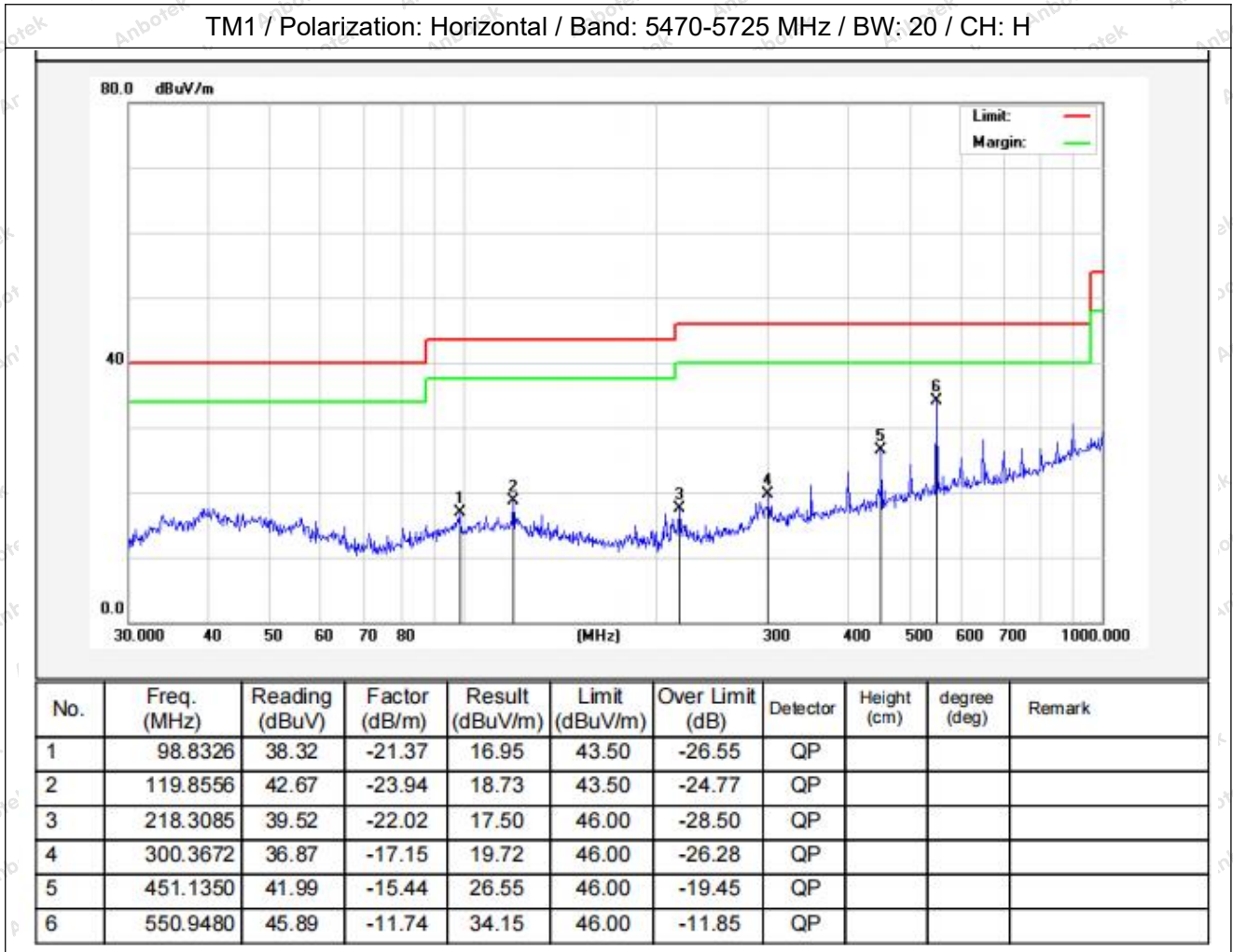

Temperature:	24.9 °C	Humidity:	44 %	Atmospheric Pressure:	101 kPa
--------------	---------	-----------	------	-----------------------	---------

TM1 / Polarization: Vertical / Band: 5470-5725 MHz / BW: 20 / CH: H

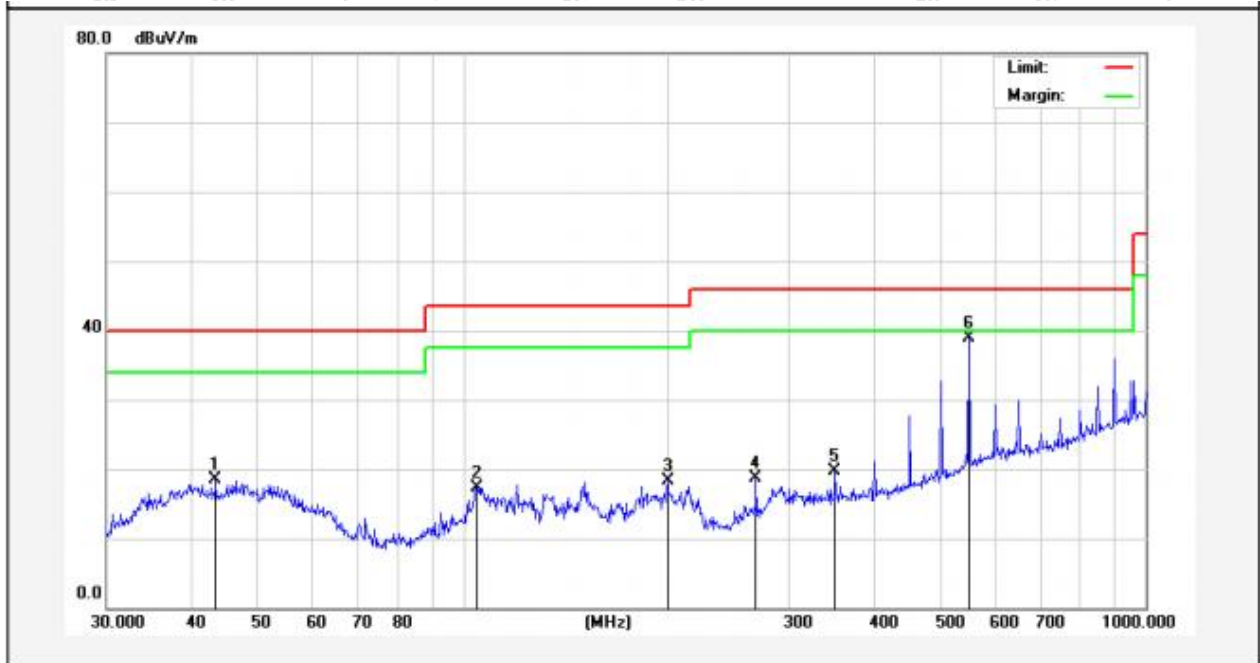

No.	Freq. (MHz)	Reading (dBuV)	Factor (dB/m)	Result (dBuV/m)	Limit (dBuV/m)	Over Limit (dB)	Detector	Height (cm)	degree (deg)	Remark
1	43.3534	33.42	-14.89	18.53	40.00	-21.47	QP			
2	104.9033	34.70	-17.36	17.34	43.50	-26.16	QP			
3	199.2855	37.94	-19.69	18.25	43.50	-25.25	QP			
4	268.4852	36.09	-17.32	18.77	46.00	-27.23	QP			
5	350.4768	34.78	-15.00	19.78	46.00	-26.22	QP			
6	550.9479	50.72	-11.74	38.98	46.00	-7.02	QP			

Note: Only record the worst data 802.11a in the report.



12. Undesirable emission limits (above 1GHz)

<p>Test Requirement:</p>	<p>47 CFR Part 15.407(b)(1) 47 CFR Part 15.407(b)(2) 47 CFR Part 15.407(b)(3) 47 CFR Part 15.407(b)(4) 47 CFR Part 15.407(b)(10)</p>																																																																											
<p>Test Limit:</p>	<p>For transmitters operating in the 5.15-5.25 GHz band: All emissions outside of the 5.15-5.35 GHz band shall not exceed an e.i.r.p. of -27 dBm/MHz.</p> <p>For transmitters operating in the 5.25-5.35 GHz band: All emissions outside of the 5.15-5.35 GHz band shall not exceed an e.i.r.p. of -27 dBm/MHz.</p> <p>For transmitters operating in the 5.47-5.725 GHz band: All emissions outside of the 5.47-5.725 GHz band shall not exceed an e.i.r.p. of -27 dBm/MHz.</p> <p>For transmitters operating solely in the 5.725-5.850 GHz band: All emissions shall be limited to a level of -27 dBm/MHz at 75 MHz or more above or below the band edge increasing linearly to 10 dBm/MHz at 25 MHz above or below the band edge, and from 25 MHz above or below the band edge increasing linearly to a level of 15.6 dBm/MHz at 5 MHz above or below the band edge, and from 5 MHz above or below the band edge increasing linearly to a level of 27 dBm/MHz at the band edge.</p> <table border="1" data-bbox="491 1070 1433 1832"> <thead> <tr> <th>MHz</th> <th>MHz</th> <th>MHz</th> <th>GHz</th> </tr> </thead> <tbody> <tr> <td>0.090-0.110</td> <td>16.42-16.423</td> <td>399.9-410</td> <td>4.5-5.15</td> </tr> <tr> <td>¹0.495-0.505</td> <td>16.69475-16.69525</td> <td>608-614</td> <td>5.35-5.46</td> </tr> <tr> <td>2.1735-2.1905</td> <td>16.80425-16.80475</td> <td>960-1240</td> <td>7.25-7.75</td> </tr> <tr> <td>4.125-4.128</td> <td>25.5-25.67</td> <td>1300-1427</td> <td>8.025-8.5</td> </tr> <tr> <td>4.17725-4.17775</td> <td>37.5-38.25</td> <td>1435-1626.5</td> <td>9.0-9.2</td> </tr> <tr> <td>4.20725-4.20775</td> <td>73-74.6</td> <td>1645.5-1646.5</td> <td>9.3-9.5</td> </tr> <tr> <td>6.215-6.218</td> <td>74.8-75.2</td> <td>1660-1710</td> <td>10.6-12.7</td> </tr> <tr> <td>6.26775-6.26825</td> <td>108-121.94</td> <td>1718.8-1722.2</td> <td>13.25-13.4</td> </tr> <tr> <td>6.31175-6.31225</td> <td>123-138</td> <td>2200-2300</td> <td>14.47-14.5</td> </tr> <tr> <td>8.291-8.294</td> <td>149.9-150.05</td> <td>2310-2390</td> <td>15.35-16.2</td> </tr> <tr> <td>8.362-8.366</td> <td>156.52475-156.52525</td> <td>2483.5-2500</td> <td>17.7-21.4</td> </tr> <tr> <td>8.37625-8.38675</td> <td>156.7-156.9</td> <td>2690-2900</td> <td>22.01-23.12</td> </tr> <tr> <td>8.41425-8.41475</td> <td>162.0125-167.17</td> <td>3260-3267</td> <td>23.6-24.0</td> </tr> <tr> <td>12.29-12.293</td> <td>167.72-173.2</td> <td>3332-3339</td> <td>31.2-31.8</td> </tr> <tr> <td>12.51975-12.52025</td> <td>240-285</td> <td>3345.8-3358</td> <td>36.43-36.5</td> </tr> <tr> <td>12.57675-12.57725</td> <td>322-335.4</td> <td>3600-4400</td> <td>(²)</td> </tr> <tr> <td>13.36-13.41</td> <td></td> <td></td> <td></td> </tr> </tbody> </table> <p>¹Until February 1, 1999, this restricted band shall be 0.490-0.510 MHz.</p> <p>²Above 38.6</p>				MHz	MHz	MHz	GHz	0.090-0.110	16.42-16.423	399.9-410	4.5-5.15	¹ 0.495-0.505	16.69475-16.69525	608-614	5.35-5.46	2.1735-2.1905	16.80425-16.80475	960-1240	7.25-7.75	4.125-4.128	25.5-25.67	1300-1427	8.025-8.5	4.17725-4.17775	37.5-38.25	1435-1626.5	9.0-9.2	4.20725-4.20775	73-74.6	1645.5-1646.5	9.3-9.5	6.215-6.218	74.8-75.2	1660-1710	10.6-12.7	6.26775-6.26825	108-121.94	1718.8-1722.2	13.25-13.4	6.31175-6.31225	123-138	2200-2300	14.47-14.5	8.291-8.294	149.9-150.05	2310-2390	15.35-16.2	8.362-8.366	156.52475-156.52525	2483.5-2500	17.7-21.4	8.37625-8.38675	156.7-156.9	2690-2900	22.01-23.12	8.41425-8.41475	162.0125-167.17	3260-3267	23.6-24.0	12.29-12.293	167.72-173.2	3332-3339	31.2-31.8	12.51975-12.52025	240-285	3345.8-3358	36.43-36.5	12.57675-12.57725	322-335.4	3600-4400	(²)	13.36-13.41			
MHz	MHz	MHz	GHz																																																																									
0.090-0.110	16.42-16.423	399.9-410	4.5-5.15																																																																									
¹ 0.495-0.505	16.69475-16.69525	608-614	5.35-5.46																																																																									
2.1735-2.1905	16.80425-16.80475	960-1240	7.25-7.75																																																																									
4.125-4.128	25.5-25.67	1300-1427	8.025-8.5																																																																									
4.17725-4.17775	37.5-38.25	1435-1626.5	9.0-9.2																																																																									
4.20725-4.20775	73-74.6	1645.5-1646.5	9.3-9.5																																																																									
6.215-6.218	74.8-75.2	1660-1710	10.6-12.7																																																																									
6.26775-6.26825	108-121.94	1718.8-1722.2	13.25-13.4																																																																									
6.31175-6.31225	123-138	2200-2300	14.47-14.5																																																																									
8.291-8.294	149.9-150.05	2310-2390	15.35-16.2																																																																									
8.362-8.366	156.52475-156.52525	2483.5-2500	17.7-21.4																																																																									
8.37625-8.38675	156.7-156.9	2690-2900	22.01-23.12																																																																									
8.41425-8.41475	162.0125-167.17	3260-3267	23.6-24.0																																																																									
12.29-12.293	167.72-173.2	3332-3339	31.2-31.8																																																																									
12.51975-12.52025	240-285	3345.8-3358	36.43-36.5																																																																									
12.57675-12.57725	322-335.4	3600-4400	(²)																																																																									
13.36-13.41																																																																												



	<p>The field strength of emissions appearing within these frequency bands shall not exceed the limits shown in § 15.209. At frequencies equal to or less than 1000 MHz, compliance with the limits in § 15.209 shall be demonstrated using measurement instrumentation employing a CISPR quasi-peak detector. Above 1000 MHz, compliance with the emission limits in § 15.209 shall be demonstrated based on the average value of the measured emissions. The provisions in § 15.35 apply to these measurements.</p> <p>Except as provided elsewhere in this subpart, the emissions from an intentional radiator shall not exceed the field strength levels specified in the following table:</p> <table border="1" data-bbox="491 672 1433 1003"> <thead> <tr> <th>Frequency (MHz)</th> <th>Field strength (microvolts/meter)</th> <th>Measurement distance (meters)</th> </tr> </thead> <tbody> <tr> <td>0.009-0.490</td> <td>2400/F(kHz)</td> <td>300</td> </tr> <tr> <td>0.490-1.705</td> <td>24000/F(kHz)</td> <td>30</td> </tr> <tr> <td>1.705-30.0</td> <td>30</td> <td>30</td> </tr> <tr> <td>30-88</td> <td>100 **</td> <td>3</td> </tr> <tr> <td>88-216</td> <td>150 **</td> <td>3</td> </tr> <tr> <td>216-960</td> <td>200 **</td> <td>3</td> </tr> <tr> <td>Above 960</td> <td>500</td> <td>3</td> </tr> </tbody> </table> <p>** Except as provided in paragraph (g), fundamental emissions from intentional radiators operating under this section shall not be located in the frequency bands 54-72 MHz, 76-88 MHz, 174-216 MHz or 470-806 MHz. However, operation within these frequency bands is permitted under other sections of this part, e.g., §§ 15.231 and 15.241. In the emission table above, the tighter limit applies at the band edges. The emission limits shown in the above table are based on measurements employing a CISPR quasi-peak detector except for the frequency bands 9–90 kHz, 110–490 kHz and above 1000 MHz. Radiated emission limits in these three bands are based on measurements employing an average detector.</p>	Frequency (MHz)	Field strength (microvolts/meter)	Measurement distance (meters)	0.009-0.490	2400/F(kHz)	300	0.490-1.705	24000/F(kHz)	30	1.705-30.0	30	30	30-88	100 **	3	88-216	150 **	3	216-960	200 **	3	Above 960	500	3
Frequency (MHz)	Field strength (microvolts/meter)	Measurement distance (meters)																							
0.009-0.490	2400/F(kHz)	300																							
0.490-1.705	24000/F(kHz)	30																							
1.705-30.0	30	30																							
30-88	100 **	3																							
88-216	150 **	3																							
216-960	200 **	3																							
Above 960	500	3																							
<p>Test Method:</p>	<p>ANSI C63.10-2020, section 12.7.4, 12.7.6, 12.7.7</p>																								
<p>Procedure:</p>	<p>Above 1GHz:</p> <ol style="list-style-type: none"> For above 1GHz, the EUT was placed on the top of a rotating table 1.5 meters above the ground at a 3 meter fully-anechoic chamber. The table was rotated 360 degrees to determine the position of the highest radiation. The EUT was set 3 meters away from the interference-receiving antenna, which was mounted on the top of a variable-height antenna tower. The antenna height is varied from one meter to four meters above the ground to determine the maximum value of the field strength. Both horizontal and vertical polarizations of the antenna are set to make the measurement. For each suspected emission, the EUT was arranged to its worst case and then the antenna was tuned to heights from 1 meter to 4 meters (for the test frequency of below 30MHz, the antenna was tuned to heights 1 meter) and the rotatable table was turned from 0 degrees to 360 degrees to find the maximum reading. The test-receiver system was set to Peak Detect Function and Specified Bandwidth with Maximum Hold Mode. If the emission level of the EUT in peak mode was 10dB lower than the limit specified, then testing could be stopped and the peak values of the EUT 																								



would be reported. Otherwise the emissions that did not have 10dB margin would be re-tested one by one using peak or average method as specified and then reported in a data sheet.

g. Test the EUT in the lowest channel, the middle channel, the Highest channel.

h. The radiation measurements are performed in X, Y, Z axis positioning for Transmitting mode, and found the X axis positioning which it is the worst case.

i. Repeat above procedures until all frequencies measured was complete.

Remark:

1. Level= Read Level+ Cable Loss+ Antenna Factor- Preamp Factor
2. Scan from 18GHz to 40GHz, the disturbance above 18GHz was very low. The points marked on above plots are the highest emissions could be found when testing, so only above points had been displayed. The amplitude of spurious emissions from the radiator which are attenuated more than 20dB below the limit need not be reported.
3. As shown in this section, for frequencies above 1GHz, the field strength limits are based on average limits. However, the peak field strength of any emission shall not exceed the maximum permitted average limits specified above by more than 20 dB under any condition of modulation. For the emissions whose peak level is lower than the average limit, only the peak measurement is shown in the report.
4. The disturbance above 18GHz were very low and the harmonics were the highest point could be found when testing, so only the above harmonics had been displayed.

12.1. EUT Operation

Operating Environment:

Test mode:

- 1: 802.11a mode: Keep the EUT connect to AC power line and works in continuously transmitting mode with 802.11a modulation type. All data rates has been tested and found the data rate @ 6Mbps is the worst case. Only the data of worst case is recorded in the report.
- 2: 802.11n mode: Keep the EUT connect to AC power line and works in continuously transmitting mode with 802.11n modulation type. All bandwidth and data rates has been tested and found the data rate @ MCS0 is the worst case. Only the data of worst case is recorded in the report.

12.2. Test Setup

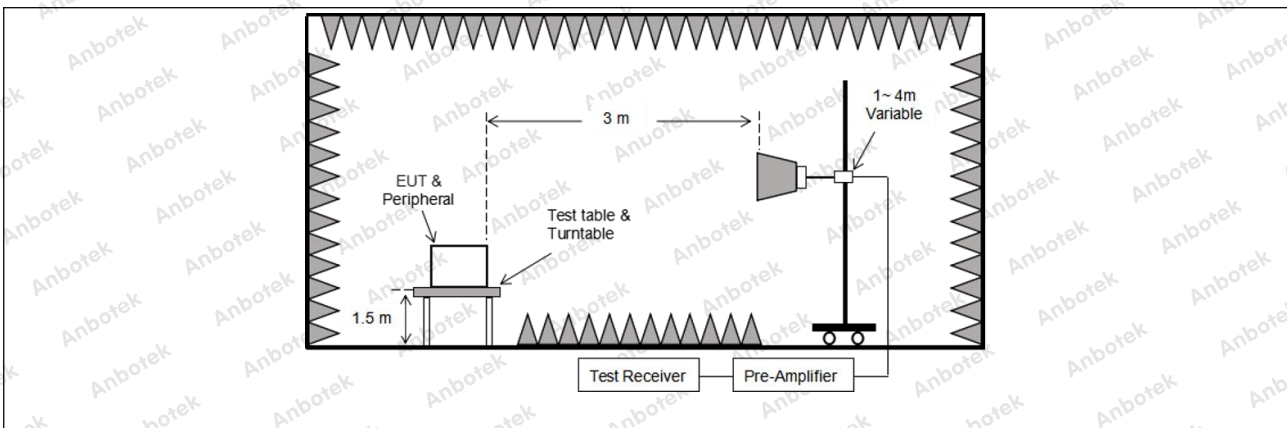

12.3. Test Data

Temperature:	24.9 °C	Humidity:	44 %	Atmospheric Pressure:	101 kPa
--------------	---------	-----------	------	-----------------------	---------

TM1 / Band: 5150-5250 MHz / BW: 20 / CH: L							
Frequency (MHz)	Reading (dBuV)	Factor (dB/m)	Result (dBuV/m)	Limit (dBuV/m)	Over limit (dB)	Antenna Pol.	Detector
10360.00	31.42	23.81	55.23	68.20	-12.97	V	Peak
15540.00	32.71	28.68	61.39	68.20	-6.81	V	Peak
10360.00	31.75	23.81	55.56	68.20	-12.64	H	Peak
15540.00	32.82	28.68	61.50	68.20	-6.70	H	Peak
10360.00	20.763	23.81	44.57	54.00	-9.43	V	AVG
15540.00	21.803	28.68	50.48	54.00	-3.52	V	AVG
10360.00	20.938	23.81	44.75	54.00	-9.25	H	AVG
15540.00	21.523	28.68	50.20	54.00	-3.80	H	AVG
TM1 / Band: 5150-5250 MHz / BW: 20 / CH: M							
Frequency (MHz)	Reading (dBuV)	Factor (dB/m)	Result (dBuV/m)	Limit (dBuV/m)	Over limit (dB)	Antenna Pol.	Detector
10400.00	30.78	23.81	54.59	68.20	10400.00	V	Peak
15600.00	32.24	29.13	61.37	68.20	15600.00	V	Peak
10400.00	31.24	23.81	55.05	68.20	10400.00	H	Peak
15600.00	32.34	29.13	61.47	68.20	15600.00	H	Peak
10400.00	21.033	23.81	44.84	54.00	10400.00	V	AVG
15600.00	21.923	29.13	51.05	54.00	15600.00	V	AVG
10400.00	20.928	23.81	44.74	54.00	10400.00	H	AVG
15600.00	21.603	29.13	50.73	54.00	15600.00	H	AVG
TM1 / Band: 5150-5250 MHz / BW: 20 / CH: H							
Frequency (MHz)	Reading (dBuV)	Factor (dB/m)	Result (dBuV/m)	Limit (dBuV/m)	Over limit (dB)	Antenna Pol.	Detector
10480.00	30.35	23.80	54.15	68.20	-14.05	V	Peak
15720.00	31.72	30.03	61.75	68.20	-6.45	V	Peak
10480.00	30.88	23.80	54.68	68.20	-13.52	H	Peak
15720.00	31.25	30.03	61.28	68.20	-6.92	H	Peak
10480.00	19.70	23.80	43.50	54.00	-10.50	V	AVG
15720.00	20.68	30.03	50.71	54.00	-3.29	V	AVG
10480.00	20.14	23.80	43.94	54.00	-10.06	H	AVG
15720.00	20.39	30.03	50.42	54.00	-3.58	H	AVG

Remark:

1. Result = Reading + Factor
2. Only record the worst data 802.11a in the report.

Shenzhen Anbotek Compliance Laboratory Limited

Address: 1/F., Building D, Sogood Science and Technology Park, Sanwei Community, Hangcheng Street, Bao'an District, Shenzhen, Guangdong, China.
 Tel: (86)0755-26066440 Fax: (86)0755-26014772 Email: service@anbotek.com

Hotline
 400-003-0500
 www.anbotek.com.cn



TM1 / Band: 5250-5350 MHz / BW: 20 / CH: L							
Frequency (MHz)	Reading (dBuV)	Factor (dB/m)	Result (dBuV/m)	Limit (dBuV/m)	Over limit (dB)	Antenna Pol.	Detector
10520.00	27.74	23.81	51.55	68.20	-16.65	V	Peak
15780.00	29.10	30.48	59.58	68.20	-8.62	V	Peak
10520.00	28.67	23.81	52.48	68.20	-15.72	H	Peak
15780.00	27.76	30.48	58.24	68.20	-9.96	H	Peak
10520.00	17.600	23.81	41.41	54.00	-12.59	V	AVG
15780.00	19.291	30.48	49.77	54.00	-4.23	V	AVG
10520.00	19.050	23.81	42.86	54.00	-11.14	H	AVG
15780.00	18.483	30.48	48.96	54.00	-5.04	H	AVG
TM1 / Band: 5250-5350 MHz / BW: 20 / CH: M							
Frequency (MHz)	Reading (dBuV)	Factor (dB/m)	Result (dBuV/m)	Limit (dBuV/m)	Over limit (dB)	Antenna Pol.	Detector
10600.00	28.93	23.87	52.80	68.20	-15.40	V	Peak
15900.00	28.15	31.38	59.53	68.20	-8.67	V	Peak
10600.00	27.97	23.87	51.84	68.20	-16.36	H	Peak
15900.00	28.18	31.38	59.56	68.20	-8.64	H	Peak
10600.00	18.270	23.87	42.14	54.00	-11.86	V	AVG
15900.00	19.041	31.38	50.42	54.00	-3.58	V	AVG
10600.00	18.330	23.87	42.20	54.00	-11.80	H	AVG
15900.00	18.633	31.38	50.01	54.00	-3.99	H	AVG
TM1 / Band: 5250-5350 MHz / BW: 20 / CH: H							
Frequency (MHz)	Reading (dBuV)	Factor (dB/m)	Result (dBuV/m)	Limit (dBuV/m)	Over limit (dB)	Antenna Pol.	Detector
10640.00	28.27	23.90	52.17	68.20	-16.03	V	Peak
15960.00	27.65	31.83	59.48	68.20	-8.72	V	Peak
10640.00	28.34	23.90	52.24	68.20	-15.96	H	Peak
15960.00	27.74	31.83	59.57	68.20	-8.63	H	Peak
10640.00	17.01	23.90	40.91	54.00	-13.09	V	AVG
15960.00	18.00	31.83	49.83	54.00	-4.17	V	AVG
10640.00	17.50	23.90	41.40	54.00	-12.60	H	AVG
15960.00	18.95	31.83	50.78	54.00	-3.22	H	AVG

Remark:

1. Result = Reading + Factor
2. Only record the worst data 802.11a in the report.

Shenzhen Anbotek Compliance Laboratory Limited

Address: 1/F., Building D, Sogood Science and Technology Park, Sanwei Community, Hangcheng Street, Bao'an District, Shenzhen, Guangdong, China.
 Tel: (86)0755-26066440 Fax: (86)0755-26014772 Email: service@anbotek.com



Hotline
 400-003-0500
 www.anbotek.com.cn



TM1 / Band: 5470-5725 MHz / BW: 20 / CH: L							
Frequency (MHz)	Reading (dBuV)	Factor (dB/m)	Result (dBuV/m)	Limit (dBuV/m)	Over limit (dB)	Antenna Pol.	Detector
11000.00	26.96	24.15	51.11	68.20	-17.09	V	Peak
16500.00	29.05	33.05	62.10	68.20	-6.10	V	Peak
11000.00	28.74	24.15	52.89	68.20	-15.31	H	Peak
16500.00	29.14	33.05	62.19	68.20	-6.01	H	Peak
11000.00	16.616	24.15	40.77	54.00	-13.23	V	AVG
16500.00	17.935	33.05	50.98	54.00	-3.02	V	AVG
11000.00	16.816	24.15	40.97	54.00	-13.03	H	AVG
16500.00	16.728	33.05	49.78	54.00	-4.22	H	AVG
TM1 / Band: 5470-5725 MHz / BW: 20 / CH: M							
Frequency (MHz)	Reading (dBuV)	Factor (dB/m)	Result (dBuV/m)	Limit (dBuV/m)	Over limit (dB)	Antenna Pol.	Detector
11200.000	26.64	23.83	50.47	68.20	-17.73	V	Peak
16800.000	27.22	32.16	59.38	68.20	-8.82	V	Peak
11200.000	27.67	23.83	51.50	68.20	-16.70	H	Peak
16800.000	27.75	32.16	59.91	68.20	-8.29	H	Peak
11200.000	16.866	23.83	40.70	54.00	-13.30	V	AVG
16800.000	18.335	32.16	50.49	54.00	-3.51	V	AVG
11200.000	17.316	23.83	41.15	54.00	-12.85	H	AVG
16800.000	18.588	32.16	50.75	54.00	-3.25	H	AVG
TM1 / Band: 5470-5725 MHz / BW: 20 / CH: H							
Frequency (MHz)	Reading (dBuV)	Factor (dB/m)	Result (dBuV/m)	Limit (dBuV/m)	Over limit (dB)	Antenna Pol.	Detector
11400.000	25.73	23.51	49.24	68.20	-18.96	V	Peak
17100.000	27.11	31.73	58.84	68.20	-9.36	V	Peak
11400.000	26.57	23.51	50.08	68.20	-18.12	H	Peak
17100.000	27.75	31.73	59.48	68.20	-8.72	H	Peak
11400.000	16.25	23.51	39.76	54.00	-14.24	V	AVG
17100.000	17.54	31.73	49.27	54.00	-4.73	V	AVG
11400.000	20.11	23.51	43.62	54.00	-10.38	H	AVG
17100.000	18.38	31.73	50.11	54.00	-3.89	H	AVG

Remark:

1. Result = Reading + Factor
2. Only record the worst data 802.11a in the report.

Shenzhen Anbotek Compliance Laboratory Limited

Address: 1/F., Building D, Sogood Science and Technology Park, Sanwei Community, Hangcheng Street, Bao'an District, Shenzhen, Guangdong, China.
 Tel: (86)0755-26066440 Fax: (86)0755-26014772 Email: service@anbotek.com



Hotline
 400-003-0500
 www.anbotek.com.cn



TM1 / Band: 5725-5850 MHz / BW: 20 / CH: L							
Frequency (MHz)	Reading (dBuV)	Factor (dB/m)	Result (dBuV/m)	Limit (dBuV/m)	Over limit (dB)	Antenna Pol.	Detector
11490.000	28.49	23.36	51.85	68.20	-16.35	V	Peak
17235.000	29.80	31.97	61.77	68.20	-6.43	V	Peak
11490.000	28.90	23.36	52.26	68.20	-15.94	H	Peak
17235.000	30.04	31.97	62.01	68.20	-6.19	H	Peak
11490.000	17.75	23.36	41.11	54.00	-12.89	V	AVG
17235.000	18.49	31.97	50.46	54.00	-3.54	V	AVG
11490.000	17.93	23.36	41.29	54.00	-12.71	H	AVG
17235.000	18.02	31.97	49.99	54.00	-4.01	H	AVG
TM1 / Band: 5725-5850 MHz / BW: 20 / CH: M							
Frequency (MHz)	Reading (dBuV)	Factor (dB/m)	Result (dBuV/m)	Limit (dBuV/m)	Over limit (dB)	Antenna Pol.	Detector
11570.000	29.07	23.42	52.49	68.20	-15.71	V	Peak
17355.000	29.68	32.18	61.86	68.20	-6.34	V	Peak
11570.000	29.10	23.42	52.52	68.20	-15.68	H	Peak
17355.000	30.13	32.18	62.31	68.20	-5.89	H	Peak
11570.000	19.024	23.42	42.44	54.00	-11.56	V	AVG
17355.000	18.811	32.18	50.99	54.00	-3.01	V	AVG
11570.000	18.918	23.42	42.34	54.00	-11.66	H	AVG
17355.000	18.398	32.18	50.58	54.00	-3.42	H	AVG
TM1 / Band: 5725-5850 MHz / BW: 20 / CH: H							
Frequency (MHz)	Reading (dBuV)	Factor (dB/m)	Result (dBuV/m)	Limit (dBuV/m)	Over limit (dB)	Antenna Pol.	Detector
11650.000	28.58	23.49	52.07	68.20	-16.13	V	Peak
17475.000	29.92	32.39	62.31	68.20	-5.89	V	Peak
11650.000	28.84	23.49	52.33	68.20	-15.87	H	Peak
17475.000	29.74	32.39	62.13	68.20	-6.07	H	Peak
11650.000	18.09	23.49	41.58	54.00	-12.42	V	AVG
17475.000	18.61	32.39	51.00	54.00	-3.00	V	AVG
11650.000	18.10	23.49	41.59	54.00	-12.41	H	AVG
17475.000	18.37	32.39	50.76	54.00	-3.24	H	AVG

Remark:

1. Result = Reading + Factor
2. Only record the worst data 802.11a in the report.

Shenzhen Anbotek Compliance Laboratory Limited

Address: 1/F., Building D, Sogood Science and Technology Park, Sanwei Community, Hangcheng Street, Bao'an District, Shenzhen, Guangdong, China.
 Tel: (86)0755-26066440 Fax: (86)0755-26014772 Email: service@anbotek.com

Hotline 400-003-0500
 www.anbotek.com.cn



APPENDIX I -- TEST SETUP PHOTOGRAPH

Please refer to separated files Appendix I -- Test Setup Photograph_RF

APPENDIX II -- EXTERNAL PHOTOGRAPH

Please refer to separated files Appendix II -- External Photograph

APPENDIX III -- INTERNAL PHOTOGRAPH

Please refer to separated files Appendix III -- Internal Photograph

----- End of Report -----

Shenzhen Anbotek Compliance Laboratory Limited

Address: 1/F., Building D, Sogood Science and Technology Park, Sanwei Community,
Hangcheng Street, Bao'an District, Shenzhen, Guangdong, China.
Tel: (86)0755-26066440 Fax: (86)0755-26014772 Email: service@anbotek.com



Hotline
400-003-0500
www.anbotek.com.cn

