



QUICK START GUIDE

Wireless IP Camera

Thank you for using SmartCam View. Please setup the camera by following the steps below :

1.In order to connect the camera stably, please install it in the range that could strongly accept the Wi-Fi signal of the home wireless router. Before installing the camera, please determine the installation location(flat surface or wall)

When the camera is installed in a place where is difficult to obtain Wi-Fi signal, please use a Wi-Fi extender to extend the Wi-Fi network range.

2.Connect power adapter to the camera
Please keep the wires away from children to avoid any potential danger.

In order to get the best image quality, please don't touch the camera lens with your hands.

Please make sure to use the matching power adapter cable, or the camera may not work properly.

1 APP Installation

1. Download the APP

● Download the "SmartCam View" app from the App Store(IOS devices) or Google Play (Android devices).

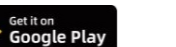
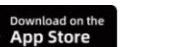

01

● Scan the QR code below to download the APP



For IOS



For Android

2.Connect the power connector to the camera and plug the power adapter into a power outlet. Wait until the camera status LED turns solid red.

3.Create an account and tap "Add Device" to add a device into your device list, follow the instructions to complete the setup.

Recommended system specifications

Wi-Fi 802.11 b/g/n

IOS 11.0 or higher

Android OS 6.0 or higher

Application pre-check function

Make full use of SmartCam View to monitor your home(the supported functions may be varied by different models) :

Event notification

Motion/Human/Vehicle/Package/Sound detection

Customized real-time monitoring

Voice intercom

02

2 Register an account

Run SmartCam View,then tap <Sign Up>.

Input user's information then tap <Get Verification Code>, Verification code will be sent to your email.

Input the verification code,read and accept the relevant privacy policy,then tap <Sign Up>.

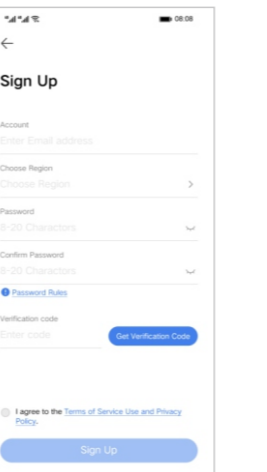
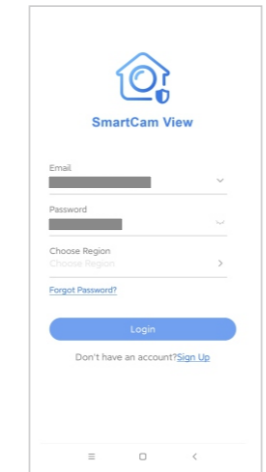

03

Return to the login interface, input user name and password,Choose Region, then tap <Login>.

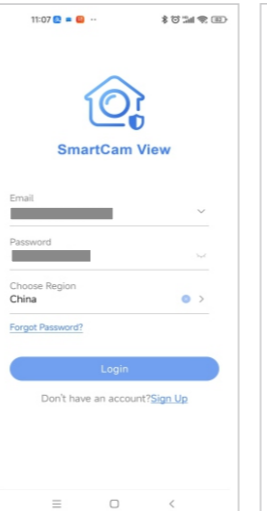

After tap <Login> will reach the Home menu.

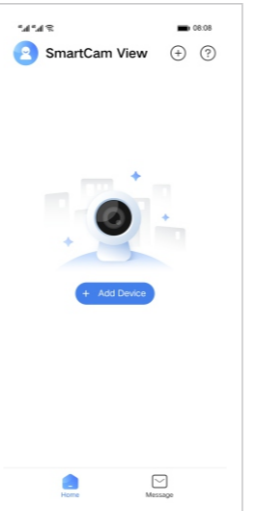

04

3 Adding Device

Connect power adapter to the camera. Plug the adapter into an outlet. Wait until the camera indicator light on. Tap button<Add Device> in the middle of Home menu .

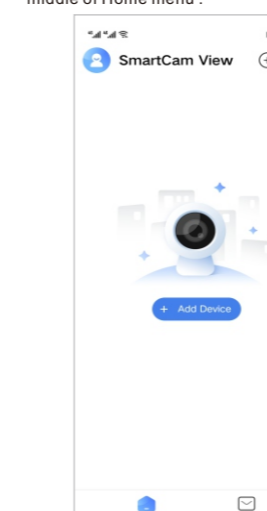

Aim the scanning window at the QR code on the camera.

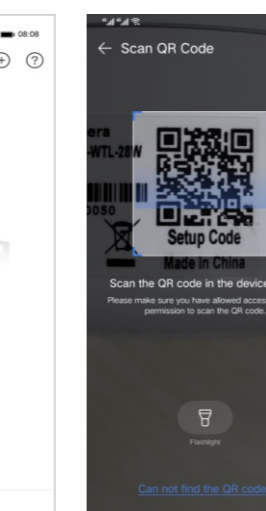

Tap button <Yes,The LED is already slowly blinking Red> when the camera LED is blinking in red.

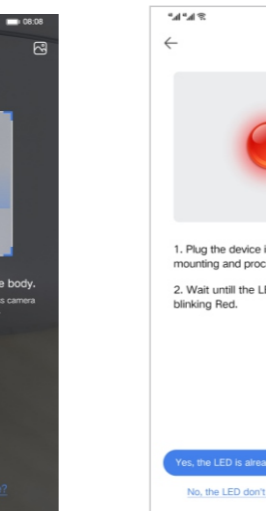

Tap button<CONNECT> to connect camera hotspot

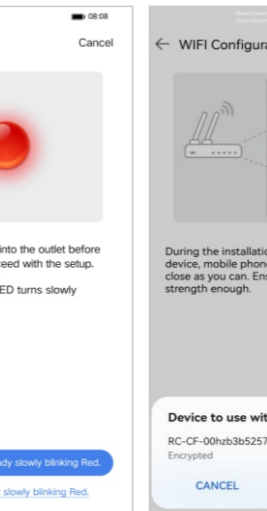

Select a 2.4 GHz WIFI network for the camera to connect and input the WIFI password, tap button <save> to connect WIFI.



Waiting for the WIFI connecting

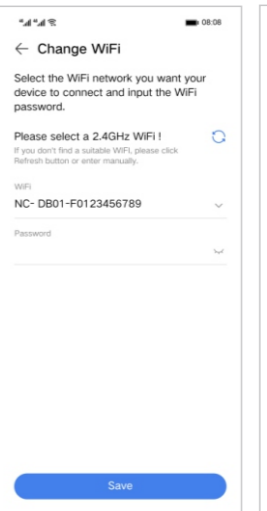

Device was added successfully and tap <Next>

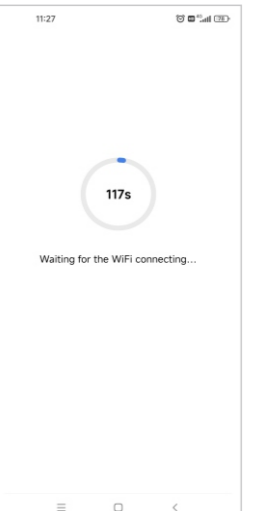

07

Set a device name, you can choose or customize a device name you want.

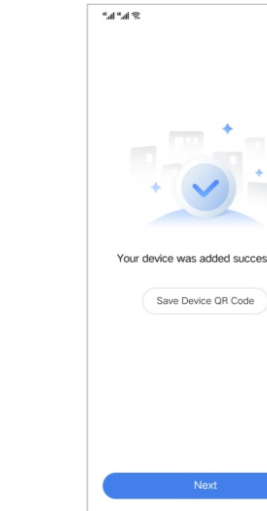

Set a device name, you can choose or customize a device name you want.

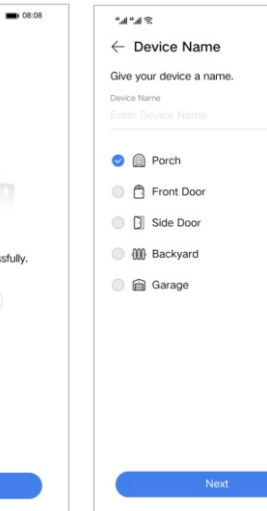

08

Choose the accurate region in where you want to setup your devices.

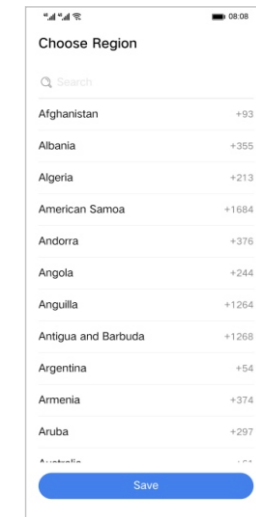

Please insert micro SD card and tap <Next> to format Micro SD. If you forgot to insert Micro SD, you can insert Micro SD and tap <Check again>

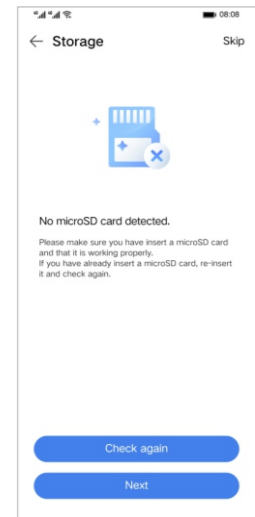

Tap <Format> to format micro SD card.

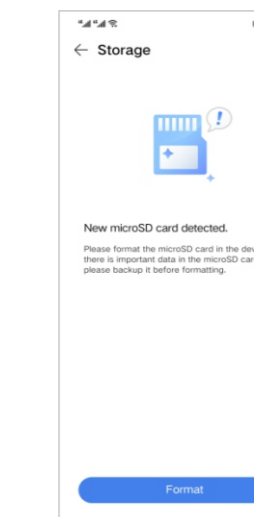

Tap <Got it> after formatting successfully.

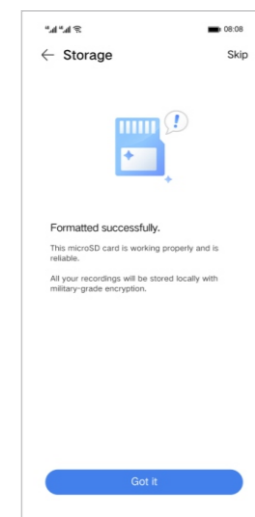

Select a desired way to mount the camera according to the installation Guide.



Tap <Finish> to finish camera configuration.

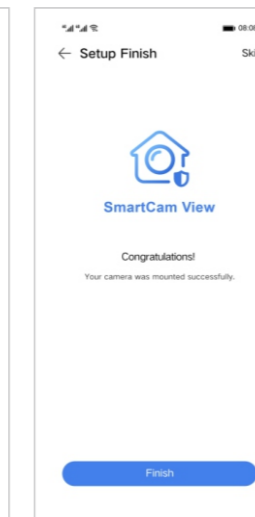

4 Mounting the Camera

Mount bullet camera onto a wall

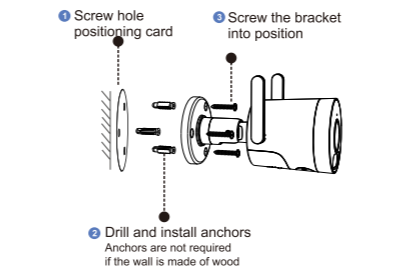

Rotate the camera to adjust the view angle and check it by using the live stream which you can access in the SmartCam View app.

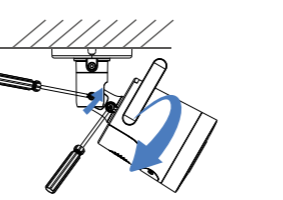

Place cube camera on a table

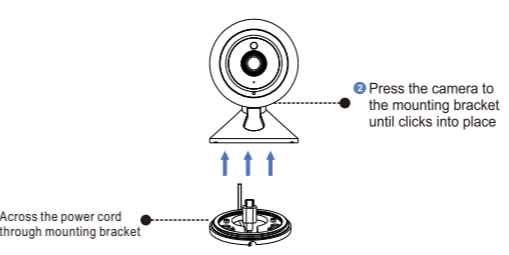

Keep a gap of more than 10 inches (25cm) between objects to the side of the camera lens to avoid overexposure caused by infrared light reflection.

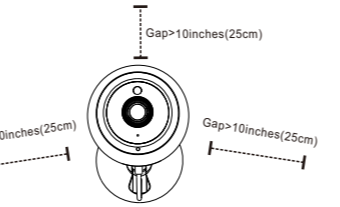

Place PT camera on a table

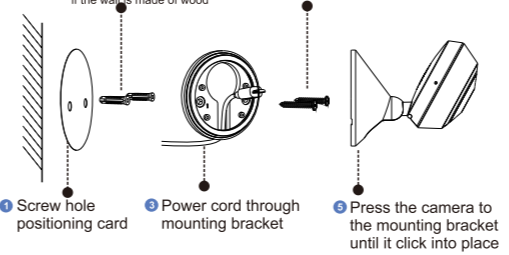

Keep a gap of more than 10 inches (25cm) between objects to the side of the camera lens to avoid overexposure caused by infrared light reflection.

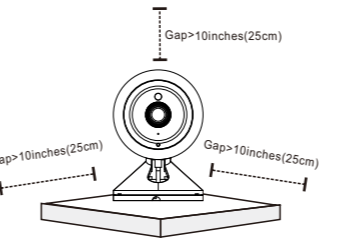

Place PT camera on a table

Keep a gap of more than 10 inches (25cm) between objects to the side of the camera lens to avoid overexposure caused by infrared light reflection.

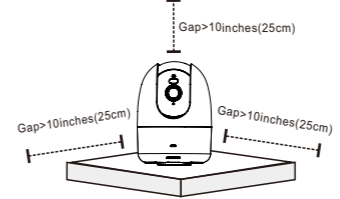

Mount the PT camera on ceiling

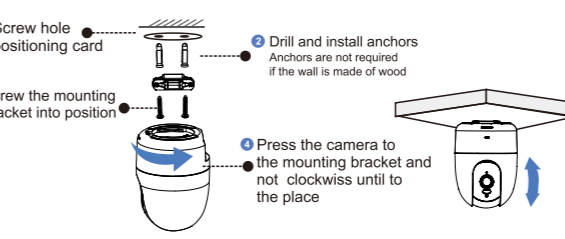

Mount the battery camera onto a wall

Keep a gap of more than 10 inches (25cm) between objects to the side of the camera lens to avoid overexposure caused by infrared light reflection.

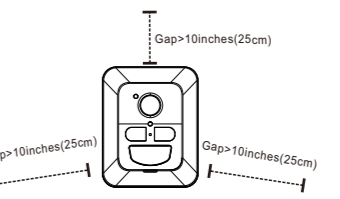

Mount with magnetic bracket

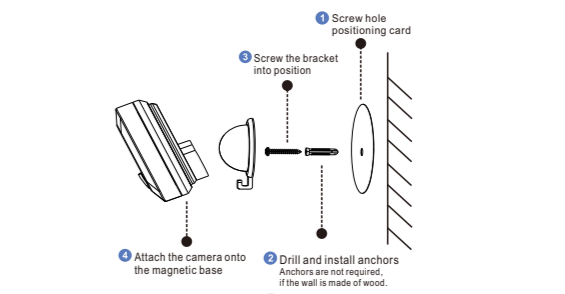

Mount with fixed bracket

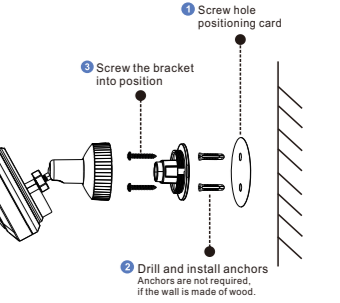

Note:

Before mounting the camera:

- Unplug the camera power connector from the power adapter.
- Find a spot where the camera can easily reach a power outlet.
- Make sure the camera receives a strong Wi-Fi connection in the spot where you want to mount it so that it can stream video to your SmartCam view app.

Caution: The user is cautioned that changes or modifications not expressly approved by the party responsible for compliance could void the user's authority to operate the equipment.

This device contains licence-exempt transmitter(s)/receiver(s) that comply with Innovation, Science and Economic Development Canada's licence-exempt RSS(s) and Part 15 of the FCC Rules. Operation is subject to the following two conditions:

(1) This device may not cause interference.

(2) This device must accept any interference, including interference that may cause undesired operation of the device.

L'émetteur/récepteur exempt de licence contenu dans le présent appareil est conforme aux CNR d'Innovation, Sciences et Développement économique Canada applicables aux appareils radio exempts de licence. L'exploitation est autorisée aux deux conditions suivantes :

(1) L'appareil ne doit pas produire de brouillage;

(2) L'appareil doit accepter tout brouillage radioélectrique subi, même si le brouillage est susceptible d'en compromettre le fonctionnement.

NOTE: This equipment has been tested and found to comply with the limits for a Class B digital device, pursuant to Part 15 of the FCC Rules. These limits are designed to provide reasonable protection against harmful interference in a residential installation. This equipment generates, uses and can radiate radio frequency energy and, if not installed and used in accordance with the instructions, may cause harmful interference to radio communications. However, there is no guarantee that interference will not occur in a particular installation.

If this equipment does cause harmful interference to radio or television reception, which can be determined by turning the equipment off and on, the user is encouraged to try to correct the interference by one or more of the following measures:

-- Reorient or relocate the receiving antenna.

-- Increase the separation between the equipment and receiver.

-- Connect the equipment into an outlet on a circuit different from that to which the receiver is connected.

-- Consult the dealer or an experienced radio/TV technician for help.

FCC& IC Radiation Exposure Statement:

This equipment complies with FCC and Canada radiation exposure limits set forth for an uncontrolled environment. This equipment should be installed and operated with a minimum distance of 20cm between the radiator and your body.

This transmitter must not be co-located or operating in conjunction with any other antenna or transmitter.

Déclaration d'IC sur l'exposition aux radiations:

Cet équipement est conforme aux limites d'exposition aux radiations définies par le Canada pour des environnements non contrôlés. Cet équipement doit être installé et utilisé à une distance minimum de 20 cm entre l'antenne et votre corps.

Cet émetteur ne doit pas être installé au même endroit ni utilisé avec une autre antenne ou un autre émetteur.