



RF TEST REPORT

Product Name: STROKE MASTER PLUS

Model Name: MAXSTRPLUS

FCC ID: 2A84DMAXSTRPLUS

Issued For : INNOVATION STREET PTE.LTD.

141 CECIL STREET #08-07 TUNG ANN
ASSOCIATION BUILDING SINGAPORE 069541

Issued By : Shenzhen LGT Test Service Co., Ltd.

Room 205, Building 13, Zone B, Chen Hsong
Industrial Park, No.177 Renmin West Road, Jinsha
Community, Kengzi Street, Pingshan New District,
Shenzhen, China

Report Number: LGT22J052RF03

Sample Received Date: Nov. 23, 2022

Date of Tested: Nov. 23, 2022 – Dec. 26, 2022

Date of Issue: Dec. 26, 2022

The test report is effective only with both signature and specialized stamp. This report shall not be reproduced except in full without the written approval of the Laboratory. The results in this report only apply to the tested sample.



TEST REPORT CERTIFICATION

Applicant INNOVATION STREET PTE.LTD.
Address 141 CECIL STREET #08-07 TUNG ANN ASSOCIATION BUILDING SINGAPORE 069541
Manufacturer INNOVATION STREET PTE.LTD.
Address 141 CECIL STREET #08-07 TUNG ANN ASSOCIATION BUILDING SINGAPORE 069541
Product Name STROKE MASTER PLUS
Trademark N/A
Model Name MAXSTRPLUS
Sample Status: Normal

APPLICABLE STANDARDS	
STANDARD	TEST RESULTS
FCC Part 15.231, Subpart C ANSI C63.10-2013	PASS

Prepared by:

Zane Shan

Zane Shan
Engineer

Approved by:

Vita Li

Vita Li
Technical Director





TABLE OF CONTENTS	Page
1. SUMMARY OF TEST RESULTS	6
1.1 TEST FACTORY	7
1.2 MEASUREMENT UNCERTAINTY	7
2. GENERAL INFORMATION	8
2.1 GENERAL DESCRIPTION OF THE EUT	8
2.2 DESCRIPTION OF THE TEST MODES	9
2.3 DESCRIPTION OF NECESSARY ACCESSORIES AND SUPPORT UNITS	9
2.4 EQUIPMENTS LIST	10
3. EMC EMISSION TEST	11
3.1 CONDUCTED EMISSION MEASUREMENT	11
3.2 TEST PROCEDURE	12
3.3 TEST SETUP	12
3.4 TEST RESULTS	13
4. RADIATED EMISSION MEASUREMENT	15
4.1 RADIATED EMISSION LIMITS	15
4.2 TEST PROCEDURE	17
4.3 DEVIATION FROM TEST STANDARD	17
4.4 TEST SETUP	18
4.5 EUT OPERATING CONDITIONS	19
4.6 TEST RESULTS	19
4.7 FIELD STRENGTH CALCULATION	20
5. BANDWIDTH TEST	25
5.1 LIMIT	25
5.2 TEST REQUIREMENTS	25
5.3 TEST PROCEDURE	25
5.4 TEST SETUP	25
5.5 EUT OPERATION CONDITIONS	25
5.6 TEST RESULTS	25
6. DUTY CYCLE	27
6.1 TEST PROCEDURE	27
6.2 TEST SETUP	27
6.3 EUT OPERATION CONDITIONS	27
6.4 TEST RESULTS	28



TABLE OF CONTENTS

	Page
7. AUTOMATICALLY DEACTIVATE	30
7.1 STANDARD REQUIREMENT	30
7.2 TEST PROCEDURE	30
8. ANTENNA REQUIREMENT	32
8.1 STANDARD REQUIREMENT	32
8.2 EUT ANTENNA	32
APPENDIX I - PHOTOS OF TEST SETUP	33



Revision History

Rev.	Issue Date	Contents
00	Dec. 26, 2022	Initial Issue



1. SUMMARY OF TEST RESULTS

Test procedures according to the technical standards:

FCC Part 15.231, Subpart C			
Standard Section	Test Item	Judgment	Remark
15.207	Conducted Emission	PASS	--
15.205(a)/15.209/ 15.231.(b)	Radiated Spurious Emission	PASS	--
15.231(a)(1)/ 15.231(b)(2)	Transmission requirement	PASS	--
15.231(C)	20 dB Bandwidth	PASS	--
15.203	Antenna Requirement	PASS	--

NOTE: (1) 'N/A' denotes test is not applicable in this Test Report.

(2) All tests are according to ANSI C63.10-2013.



1.1 TEST FACTORY

Company Name:	Shenzhen LGT Test Service Co., Ltd.
Address:	Room 205, Building 13, Zone B, Chen Hsong Industrial Park, No.177 Renmin West Road, Jinsha Community, Kengzi Street, Pingshan New District, Shenzhen, China
Accreditation Certificate	A2LA Certificate No.: 6727.01
	FCC Registration No.: 746540
	CAB ID: CN0136

1.2 MEASUREMENT UNCERTAINTY

The reported uncertainty of measurement $y \pm U$, where expanded uncertainty U is based on a standard uncertainty multiplied by a coverage factor of $k=2$, providing a level of confidence of approximately **95** %.

Parameter	Uncertainty
RF Output Power, Conducted	$\pm 0.71\text{dB}$
Unwanted Emission, Conducted	$\pm 0.63\text{dB}$
Conducted emission	$\pm 2.80\text{dB}$
All Emissions, Radiated (0.009-30MHz)	$\pm 2.16\text{dB}$
All Emissions, Radiated (30MHz-1GHz)	$\pm 4.40\text{dB}$
All Emissions, Radiated (1GHz-18GHz)	$\pm 5.49\text{dB}$



2. GENERAL INFORMATION

2.1 GENERAL DESCRIPTION OF THE EUT

Product Name	STROKE MASTER PLUS
Trademark	N/A
Model Name	MAXSTRPLUS
Series Model	N/A
Model Difference	N/A
Frequency band	433.925MHz
Power Rating	N/A
Modulation Type	ASK
Hardware version number	V1.0
Software version number	V1.1
Connecting I/O Port(s)	N/A

Note:

1. For a more detailed features description, please refer to the manufacturer's specifications or the User Manual.

2. Table for filed Antenna

Ant.	Brand	Model Name	Antenna Type	Connector	Gain (dBi)	NOTE
1	N/A	N/A	PCB Antenna	N/A	-20	Antenna

Note: The antenna information refer the manufacturer provide report, applicable only to the tested sample identified in the report.



2.2 DESCRIPTION OF THE TEST MODES

To investigate the maximum EMI emission characteristics generated from EUT, the test system was pre-scanned based on the consideration of following EUT operation mode or test configuration mode which possibly have effect on EMI emission level. Each of these EUT operation mode(s) or test configuration mode(s) mentioned above was evaluated respectively.

Pretest Mode	Description
Mode 1	TX Mode
Mode 1	Charging + TX Mode

For Conducted Emission	
Final Test Mode	Description
Mode 2	Charging + TX Mode

For Radiated Emission	
Final Test Mode	Description
Mode 1	TX Mode

2.3 DESCRIPTION OF NECESSARY ACCESSORIES AND SUPPORT UNITS

The EUT has been tested as an independent unit together with other necessary accessories or support units. The following support units or accessories were used to form a representative test configuration during the tests.

Accessories Equipment

Description	Manufacturer	Model	S/N	Rating
USB cable	N/A	N/A	N/A	1m, unshielded

Auxiliary Equipment

Description	Manufacturer	Model	S/N	Rating
Adapter	TEN PAO INDUSTRIAL CO LTD	S010WU050020 0	N/A	Input: 100-240V ~ 50/60Hz 0.2A Output: 5V@2A

Note:

(1) For detachable type I/O cable should be specified the length in cm in 『Length』 column.



2.4 EQUIPMENTS LIST

Radiated Test equipment					
Equipment	Manufacturer	Model No.	Serial No.	Cal. Date	Cal. Until
EMI Test Receiver	R&S	ESU8	100372	2022.04.12	2023.04.11
Active loop Antenna	R&S	HFH2-Z2	POS871398181	2022.06.02	2024.06.01
Spectrum Analyzer	Kesight	N9010B	MY60242508	2022.04.29	2023.04.28
Bilog Antenna	SCHAFFNER	CBL6112B	2705	2022.06.05	2024.06.04
Horn Antenna	Schwarzbeck	3115	10SL0060	2022.06.02	2024.06.01
Pre-amplifier(0.1M-3GHz)	HP	8447D	2727A05655	2022.04.11	2023.04.10
Pre-amplifier(1-26.5G)	Agilent	8449B	3008A4722	2022.04.13	2023.04.12
RE Cable (9K-1G)	N.A	R01	N.A	2022.05.05	2023.05.04
RE Cable (1-26G)	N.A	R02	N.A	2022.05.05	2023.05.04
Wireless Communications Test Set	R&S	CMW 500	137737	2022.04.29	2023.04.28
Temperature & Humidity	KTJ	TA218B	N.A	2022.05.05	2023.05.04
Testing Software	EMC-I_V1.4.0.3_SKET				

Conducted Test equipment					
Equipment	Manufacturer	Model No.	Serial No.	Cal. Date	Cal. Until
Signal Analyzer	Keysight	N9010B	MY60242508	2022.04.29	2023.04.28
RF Automatic Test system	MW	MW200-RFCB	MW220322LG	2022.04.29	2023.04.28
MXG Vector Signal Generator	Keysight	N5182B	MY59100717	2022.06.02	2023.06.01
Temperature & Humidity	KTJ	TA218B	N.A	2022.05.05	2023.05.04
Temperature & Humidity test chamber	AISRY	LX-1000L	171200018	2022.05.10	2023.05.09
Attenuator	eastsheep	90db	N.A	2022.04.29	2023.04.28
Router	WAVLINK	WL-WN575A2	WL1512260336	N.C.R	N.C.R
Router	TP-LINK	TL-WR885N	1125074010735	N.C.R	N.C.R
Testing Software	MTS8310_V2.0.0.0_MW				

Conducted Emission					
Equipment	Manufacturer	Model No.	Serial No.	Cal. Date	Cal. Until
EMI Test Receiver	R&S	ESU8	100372	2022.04.12	2023.04.11
LISN	COM-POWER	LI-115	02032	2022.04.13	2023.04.12
LISN	SCHWARZBECK	NNLK 8121	00847	2022.08.19	2023.08.18
CE Cable	N.A	C01	N.A	2022.05.05	2023.05.04
Transient Limiter	CYBERTEK	EM5010A	E2250100049	2022.08.19	2023.08.18
Temperature & Humidity	KTJ	TA218B	N.A	2022.05.05	2023.05.04
Testing Software	EMC-I_V1.4.0.3_SKET				



3. EMC EMISSION TEST

3.1 CONDUCTED EMISSION MEASUREMENT

3.1.1 POWER LINE CONDUCTED EMISSION LIMITS

The radio frequency voltage that is conducted back onto the AC power line on any frequency or frequencies, within the band 150 kHz to 30 MHz, shall not exceed the limits in the following table.

FREQUENCY (MHz)	Class B (dBuV)		Standard
	Quasi-peak	Average	
0.15 -0.5	66 - 56 *	56 - 46 *	CISPR
0.50 -5.0	56.00	46.00	CISPR
5.0 -30.0	60.00	50.00	CISPR
0.15 -0.5	66 - 56 *	56 - 46 *	FCC
0.50 -5.0	56.00	46.00	FCC
5.0 -30.0	60.00	50.00	FCC

Note:

- (1) The tighter limit applies at the band edges.
- (2) The limit of “ * ” marked band means the limitation decreases linearly with the logarithm of the frequency in the range.

The following table is the setting of the receiver

Receiver Parameters	Setting
Attenuation	10 dB
Start Frequency	0.15 MHz
Stop Frequency	30 MHz
IF Bandwidth	9 kHz



3.2 TEST PROCEDURE

- a. The EUT is 0.8 m from the horizontal ground plane and 0.4 m from the vertical ground plane with EUT being connected to the power mains through a line impedance stabilization network (LISN). All other support equipments are powered from additional LISN(s). The LISN provides 50 Ohm/ 50uH of coupling impedance for the measuring instrument.
- b. Interconnecting cables that hang closer than 40 cm to the ground plane shall be folded back and forth in the center forming a bundle 30 to 40 cm long.
- c. I/O cables that are not connected to a peripheral shall be bundled in the center. The end of the cable may be terminated, if required, using the correct terminating impedance. The overall length shall not exceed 1 m.
- d. LISN at least 80 cm from nearest part of EUT chassis.
- e. For the actual test configuration, please refer to the related Item –EUT Test Photos.

3.3 TEST SETUP

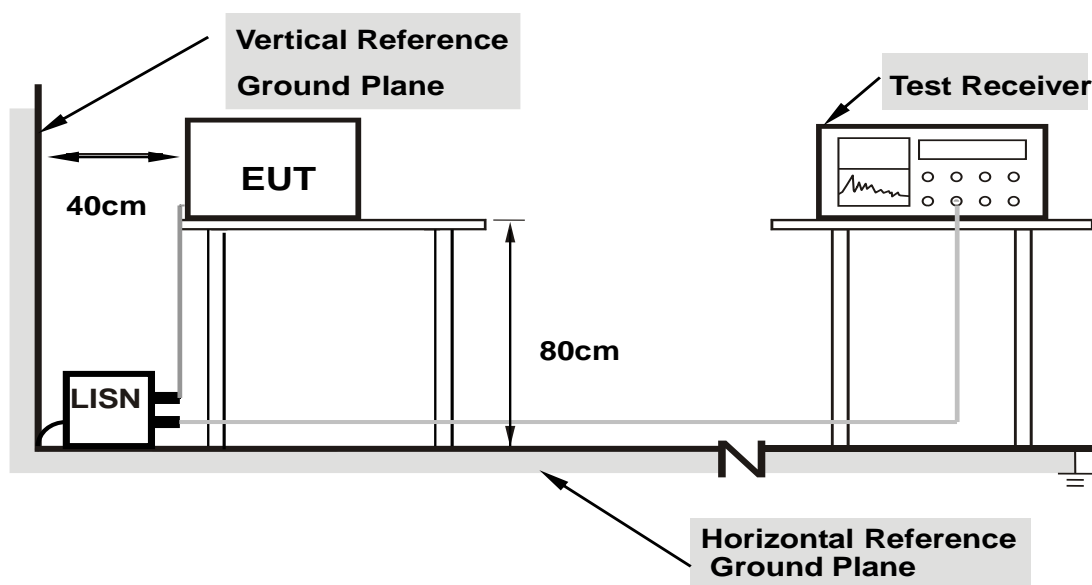

Note: 1. Support units were connected to second LISN.

2. Both of LISNs (AMN) are 80 cm from EUT and at least 80 cm from other units and other metal planes support units.



3.4 TEST RESULTS

Project: LGT22J052	Test Engineer: Dylan.shi
EUT: Maxtasy Stroke	Temperature: 22.4°C
M/N: MAXSTRPLUS	Humidity: 57%RH
Test Voltage: AC 120V/60Hz	Test Data: 2022-11-29
Test Mode: Charging + TX	
Note:	

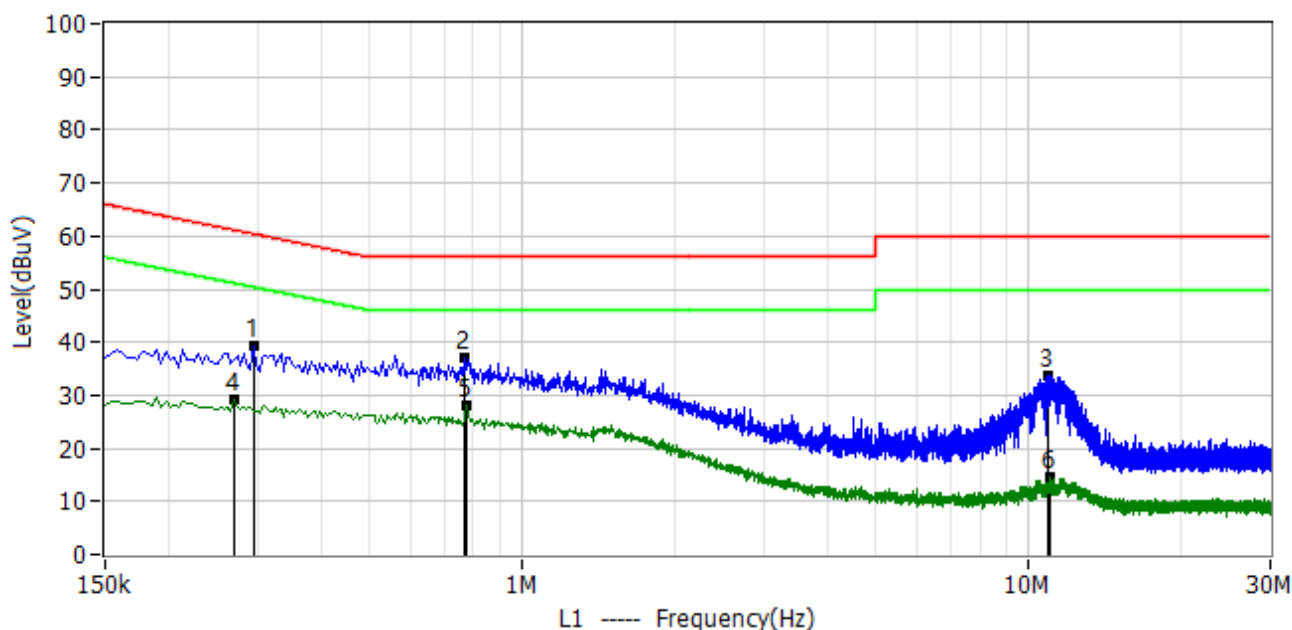

No.	Frequency	Reading dBuV	Factor dB	Level dBuV	Limit dBuV	Margin dB	Detector	Polar
1*	294.000kHz	28.82	10.50	39.32	60.41	-21.09	PK	L1
2*	766.000kHz	26.62	10.52	37.14	56.00	-18.86	PK	L1
3*	10.930MHz	22.78	10.97	33.75	60.00	-26.25	PK	L1
4*	270.000kHz	18.64	10.50	29.14	51.12	-21.97	AV	L1
5*	778.000kHz	17.66	10.52	28.18	46.00	-17.82	AV	L1
6*	11.030MHz	3.50	10.98	14.48	50.00	-35.52	AV	L1



Project: LGT22J052	Test Engineer: Dylan.shi
EUT: Maxtasy Stroke	Temperature: 22.4°C
M/N: MAXSTRPLUS	Humidity: 57%RH
Test Voltage: AC 120V/60Hz	Test Data: 2022-11-29
Test Mode: Charging + TX	
Note:	

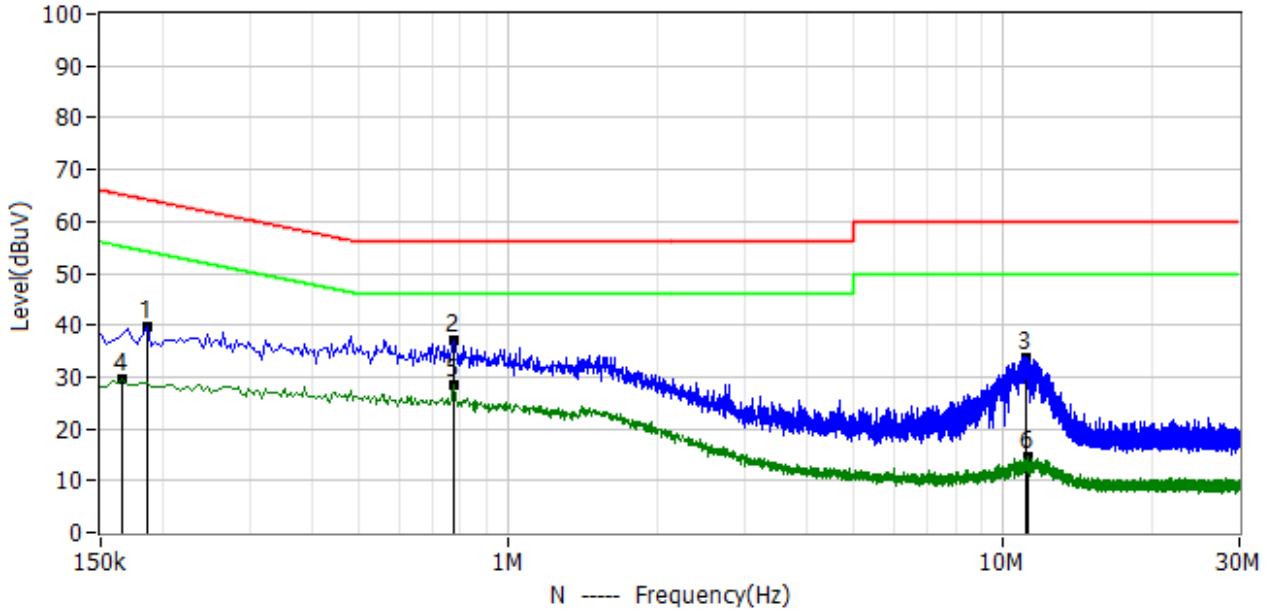

No.	Frequency	Reading dBuV	Factor dB	Level dBuV	Limit dBuV	Margin dB	Detector	Polar
1*	186.000kHz	29.33	10.50	39.83	64.21	-24.38	PK	N
2*	774.000kHz	26.50	10.52	37.02	56.00	-18.98	PK	N
3*	11.134MHz	22.82	10.98	33.80	60.00	-26.20	PK	N
4*	166.000kHz	19.04	10.50	29.54	55.16	-25.62	AV	N
5*	778.000kHz	17.79	10.52	28.31	46.00	-17.69	AV	N
6*	11.174MHz	3.81	10.98	14.79	50.00	-35.21	AV	N



4. RADIATED EMISSION MEASUREMENT

4.1 RADIATED EMISSION LIMITS

In case the emission fall within the restricted band specified on Part 15.205(a), then the Part 15.209(a) and Part 15.231(b) limit in the table below has to be followed.

LIMITS OF RADIATED EMISSION MEASUREMENT (0.009MHz - 1000MHz)

Frequencies (MHz)	Field Strength (micorvolts/meter)	Measurement Distance (meters)
0.009~0.490	2400/F(KHz)	300
0.490~1.705	24000/F(KHz)	30
1.705~30.0	30	30
30~40.66	100	3
40.70~70	100	3

Fundamental Frequency (MHz)	Field Strength of fundamental (microvolts/meter)	Field Strength of Unwanted Emissions (microvolts/meter)
40.66~40.70	2,250	225
70~130	1,250	125
130~174	1,250 to 3,750**	125 to 375**
174~260	3750	375
260~470	3,750 to 12,500**	375 to 1,250**
Above 470	12,500	1,250

LIMITS OF RADIATED EMISSION MEASUREMENT (Above 1000MHz)

FREQUENCY (MHz)	Class B (dBuV/m) (at 3M)	
	PEAK	AVERAGE
Above 1000	74	54

NOTE:

- (1) The limit for radiated test was performed according to FCC PART 15C.
- (2) Emission level (dBuV/m)=20log Emission level (uV/m).



LIMITS OF RESTRICTED FREQUENCY BANDS

FREQUENCY (MHz)	FREQUENCY (MHz)	FREQUENCY (MHz)	FREQUENCY (GHz)
0.090-0.110	16.42-16.423	399.9-410	4.5-5.15
0.495-0.505	16.69475-16.69525	608-614	5.35-5.46
2.1735-2.1905	16.80425-16.80475	960-1240	7.25-7.75
4.125-4.128	25.5-25.67	1300-1427	8.025-8.5
4.17725-4.17775	37.5-38.25	1435-1626.5	9.0-9.2
4.20725-4.20775	73-74.6	1645.5-1646.5	9.3-9.5
6.215-6.218	74.8-75.2	1660-1710	10.6-12.7
6.26775-6.26825	108-121.94	1718.8-1722.2	13.25-13.4
6.31175-6.31225	123-138	2200-2300	14.47-14.5
8.291-8.294	149.9-150.05	2310-2390	15.35-16.2
8.362-8.366	156.52475-156.52525	2483.5-2500	17.7-21.4
8.37625-8.38675	156.7-156.9	2690-2900	22.01-23.12
8.41425-8.41475	162.0125-167.17	3260-3267	23.6-24.0
12.29-12.293	167.72-173.2	3332-3339	31.2-31.8
12.51975-12.52025	240-285	3345.8-3358	36.43-36.5
12.57675-12.57725	322-335.4	3600-4400	Above 38.6
13.36-13.41			

Spectrum Parameter	Setting
Detector	Peak
Attenuation	Auto
Start Frequency	1000 MHz
Stop Frequency	10th carrier harmonic
RB / VB (emission in restricted band)	1MHz / 3MHz

Receiver Parameter	Setting
Attenuation	Auto
Start ~ Stop Frequency	9kHz~90kHz / RB 200Hz for PK & AV
Start ~ Stop Frequency	90kHz~110kHz / RB 200Hz for QP
Start ~ Stop Frequency	110kHz~490kHz / RB 200Hz for PK & AV
Start ~ Stop Frequency	490kHz~30MHz / RB 9kHz for QP
Start ~ Stop Frequency	30MHz~1000MHz / RB 120kHz for QP



4.2 TEST PROCEDURE

- a. The test is performed in a 3m Semi-Anechoic Chamber; the antenna factor, cable loss and so on of the site (factors) is calculated to correct the reading. The EUT is placed on a 0.8m high insulating Turn Table, and keeps 3m away from the Test Antenna, which is mounted on a variable-height antenna master tower.
During test, The table was rotated 360 degrees to determine the position of the highest radiation.
- b. In the frequency range of 9KHz to 30MHz, magnetic field is measured with Loop Test Antenna. The Test Antenna is positioned with its plane vertical at 1m distance from the EUT. The center of the Loop Test Antenna is 1m above the ground. During the measurement the Loop Test Antenna rotates about its vertical axis for maximum response at each azimuth about the EUT.
- c. In the frequency range 30MHz-1GHz, Bi-Log Test Antenna used. Test Antenna is 3m away from the EUT. Test Antenna height is varied from 1m to 4m above the ground to determine the maximum value of the field strength. The emission levels at both horizontal and vertical polarizations should be tested.
- d. In the frequency above 1GHz, Place the measurement antenna 3m away from the EUT for each area of the EUT determined to be a source of emissions at the specified measurement distance, while keeping the measurement antenna aimed at the source of emissions at each frequency of significant emissions, with polarization oriented for maximum response. The measurement antenna elevation for maximum emissions shall be restricted to a range of heights of from 1 m to 4 m above the ground or reference ground plane.
- f. The initial step in collecting conducted emission data is a spectrum analyzer peak detector mode pre-scanning the measurement frequency range. Significant peaks are then marked and then Quasi Peak detector mode re-measured.
- g. If the Peak Mode measured value compliance with and lower than Quasi Peak Mode Limit, the EUT shall be deemed to meet QP Limits and then no additional QP Mode measurement performed.
- h. For the actual test configuration, please refer to the related Item –EUT Test Photos.

Both horizontal and vertical antenna polarities and performed pretest to three orthogonal axis were tested. The worst case emissions were reported

4.3 DEVIATION FROM TEST STANDARD

No deviation

4.4 TEST SETUP

(A) Radiated Emission Test-Up Frequency Below 30MHz

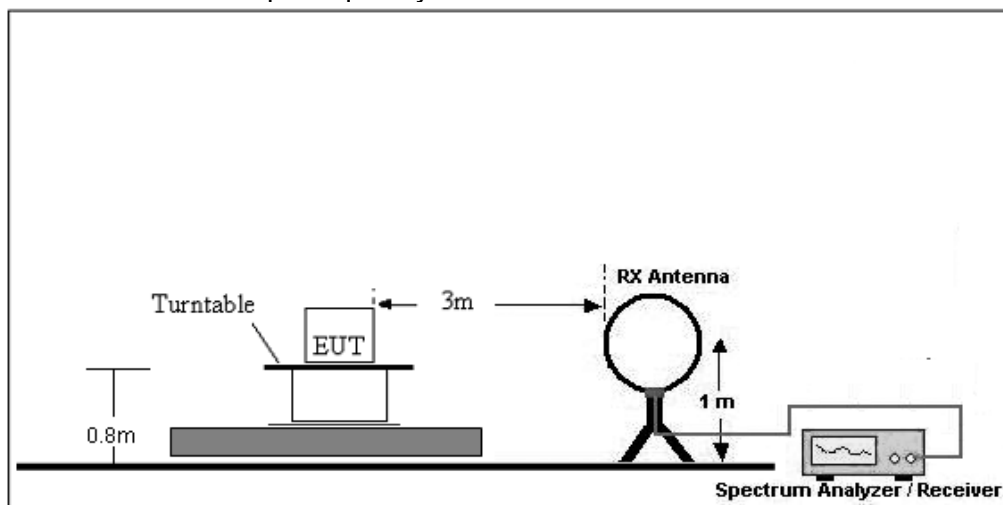

(B) Radiated Emission Test-Up Frequency 30MHz~1GHz

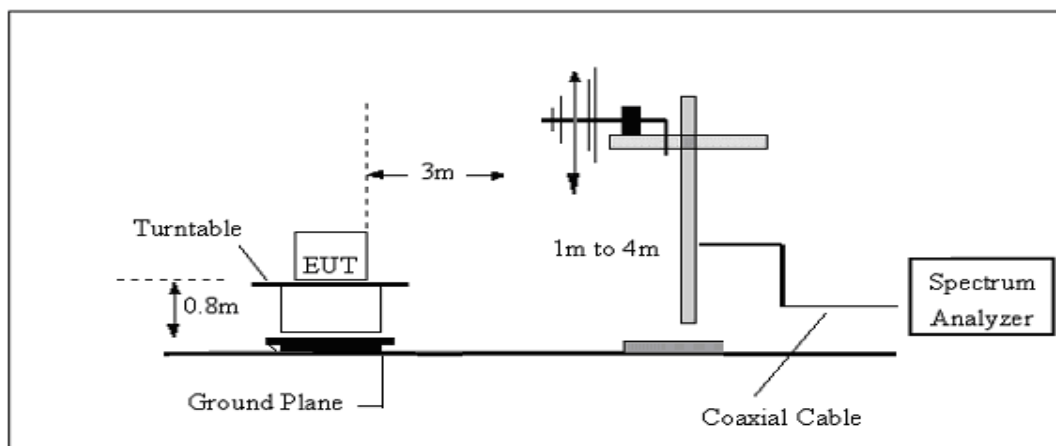

(C) Radiated Emission Test-Up Frequency Above 1GHz

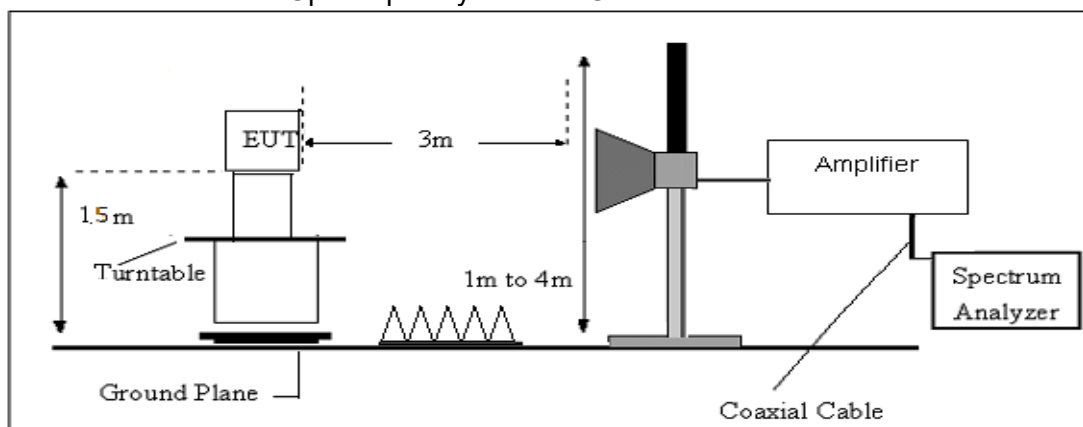



4.5 EUT OPERATING CONDITIONS

The EUT tested system was configured as the statements of 2.4 Unless otherwise a special operating condition is specified in the follows during the testing.

4.6 TEST RESULTS

INTRODUCTION TO PDCF

Reference: (§15.35 Measurement detector functions and bandwidths.)

- a. Part 15 of the FCC Rules provides for the operation of low power communication devices without an individual license (e.g., intrusion detectors, pulsed water tank level gauges, etc.), subject to certain requirements. Some of these devices use extremely narrow pulses to generate wideband emissions, which are measured to determine compliance with the rules. These measurements are typically performed with a receiver or spectrum analyzer. Depending on a number of factors (e.g., resolution bandwidth, pulsewidth, etc.), the spectrum analyzer may not always display the true peak value of the measured emission. This effect, called “pulse desensitization,” relates to the capabilities of the measuring instrument. For the measurement and reporting of the true peak of pulsed emissions, it may be necessary to apply a “pulse desensitization correction factor” (PDCF) to the measured value, pursuant to 47 CFR 15.35(a).

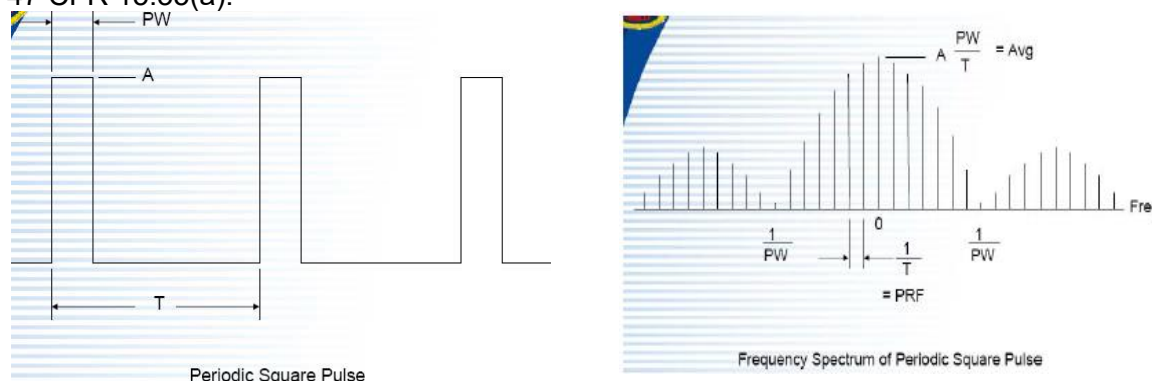

If using spectrum analyzer to measure pulse signal, it have to make sure the RBW use is at least $2/PW$.

•When RBW is less than $2/PW$, you are able to measure the true peak level of the pulse signal. If this is the case, PDCF is required to compensate to determine true peak value.

Pulse desensitization:

$PW = 42600\text{usec}$, $\text{Period} = 96600\text{usec}$, $\text{Level} = A$

$RBW > 2/PW = 0.047K$, $1/T = 0.023K$

NOTE: $2 / PW < RBW$, first don't need

- b. For the actual test, please refer to the ANSI C63.10, Annex C refer to section 6. for more detail



4.7 FIELD STRENGTH CALCULATION

The field strength is calculated by adding the Antenna Factor and Cable Factor and subtracting the Amplifier Gain and Duty Cycle Correction Factor (if any) from the measured reading. The basic equation with a sample calculation is as follows:

$$FS = RA + AF + CL - AG$$

Where

FS = Field Strength

CL = Cable Attenuation Factor (Cable Loss)

RA = Reading Amplitude

AG = Amplifier Gain

AF = Antenna Factor

For example

Frequency (MHz)	FS (dB μ V/m)	RA (dB μ V/m)	AF (dB)	CL (dB)	AG (dB)	Factor (dB)
300	40	58.1	12.2	1.6	31.9	-18.1

$$\text{Factor} = \text{AF} + \text{CL} - \text{AG}$$

4.8 TEST RESULTS

(Radiated Emission < 30MHz (9KHz-30MHz, H-field))

Freq. (MHz)	Reading (dBuV/m)	Limit (dBuV/m)	Margin (dB)	State P/F
--	--	--	--	PASS
--	--	--	--	PASS

Note: The amplitude of spurious emissions which are attenuated by more than 20dB below the permissible value has no need to be reported.

Distance extrapolation factor = $40 \log(\text{specific distance}/\text{test distance})$ (dB);

Limit line = specific limits (dBuV) + distance extrapolation factor.



Between 30MHz – 5000 MHz

Project: LGT22J052	Test Engineer: Dylan.shi
EUT: Maxtasy Stroke	Temperature: 25.2°C
M/N: MAXSTRPLUS	Humidity: 56%RH
Test Voltage: Battery	Test Data: 2022-11-29
Test Mode: 433M TX	
Note:	

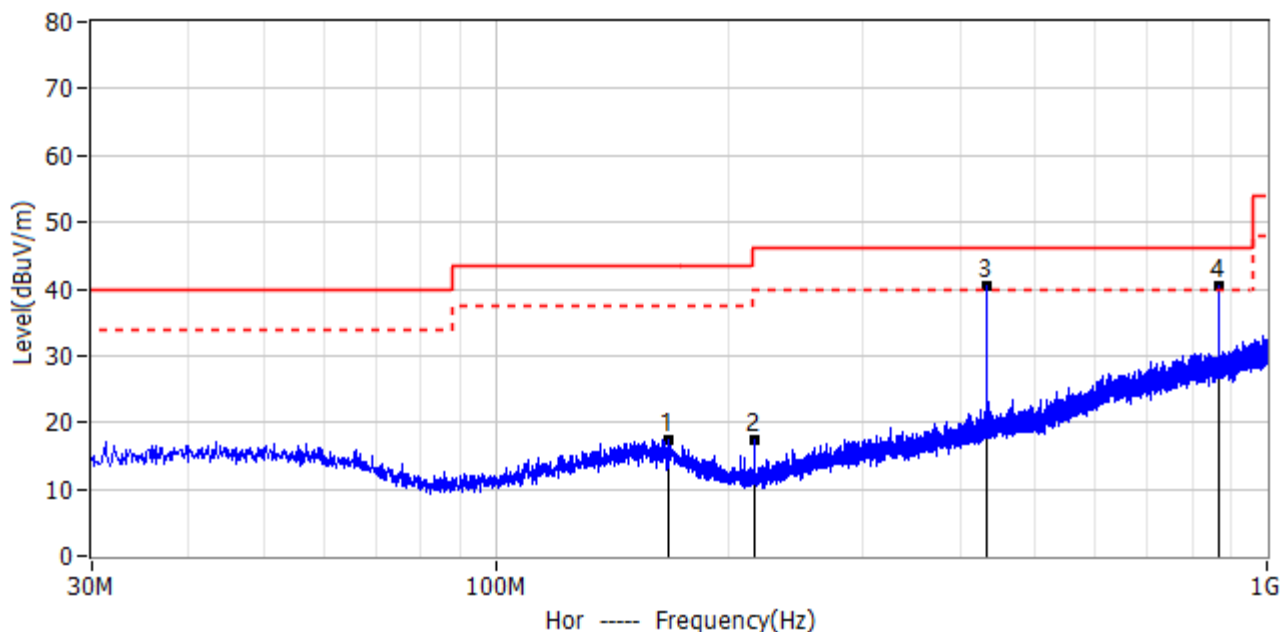

No.	Frequency	Reading dBuV	Factor dB/m	Level dBuV/m	Limit dBuV/m	Margin dB	Detector	Polar
1*	168.104MHz	3.42	13.98	17.40	43.50	-26.10	PK	Hor
2*	216.968MHz	6.68	10.71	17.39	46.00	-28.61	PK	Hor
3*	433.884MHz	22.43	18.02	40.45	100.83	-60.38	PK	Hor
4*	867.838MHz	14.07	26.29	40.36	80.83	-40.47	PK	Hor
3*	433.884MHz	40.45	-7.38	33.07	80.83	-47.75	QP	Hor
4*	867.838MHz	40.36	-7.38	32.98	60.83	-27.84	QP	Hor



Project: LGT22J052	Test Engineer: Dylan.shi
EUT: Maxtasy Stroke	Temperature: 25.2°C
M/N: MAXSTRPLUS	Humidity: 56%RH
Test Voltage: Battery	Test Data: 2022-11-29
Test Mode: 433M TX	
Note:	

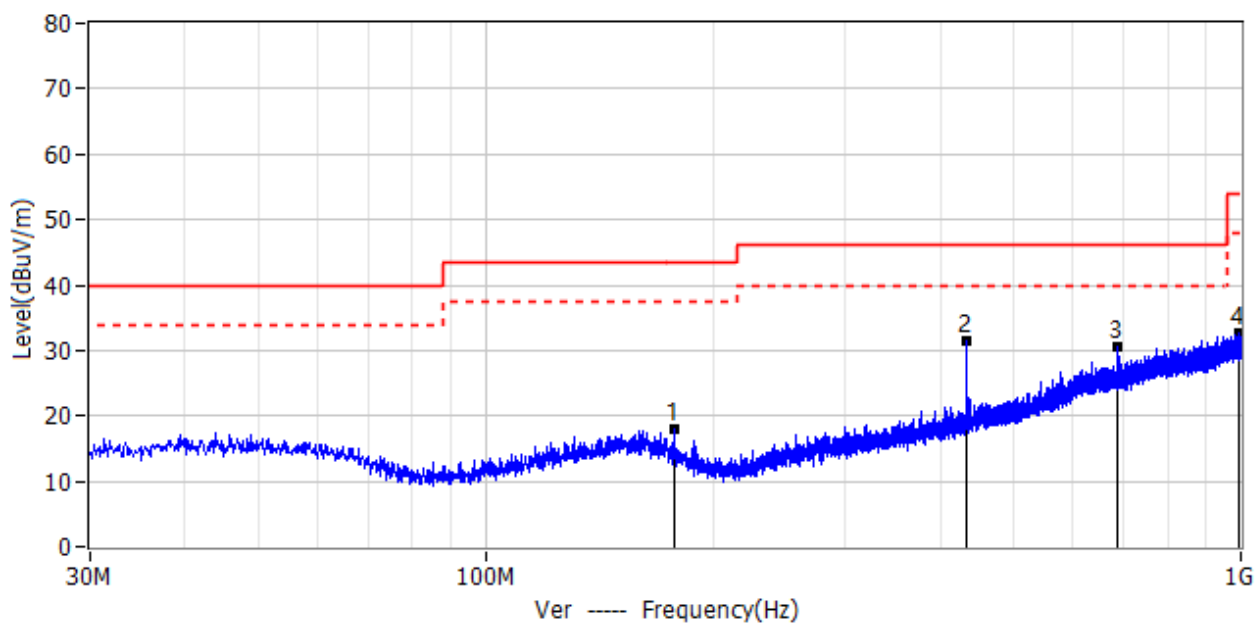

No.	Frequency	Reading dBuV	Factor dB/m	Level dBuV/m	Limit dBuV/m	Margin dB	Detector	Polar
1*	178.168MHz	5.12	12.76	17.88	43.50	-25.62	PK	Ver
2*	433.884MHz	13.50	18.02	31.52	100.83	-69.31	PK	Ver
2*	433.884MHz	31.52	-7.38	24.14	80.83	-56.68	QP	Ver
3*	687.539MHz	7.22	23.39	30.61	46.00	-15.39	PK	Ver
4*	996.241MHz	4.81	27.87	32.68	54.00	-21.32	PK	Ver



Project: LGT22J052	Test Engineer: Dylan.shi
EUT: Maxtasy Stroke	Temperature: 25.2°C
M/N: MAXSTRPLUS	Humidity: 56%RH
Test Voltage: Battery	Test Data: 2022-11-29
Test Mode: 433M TX	
Note:	

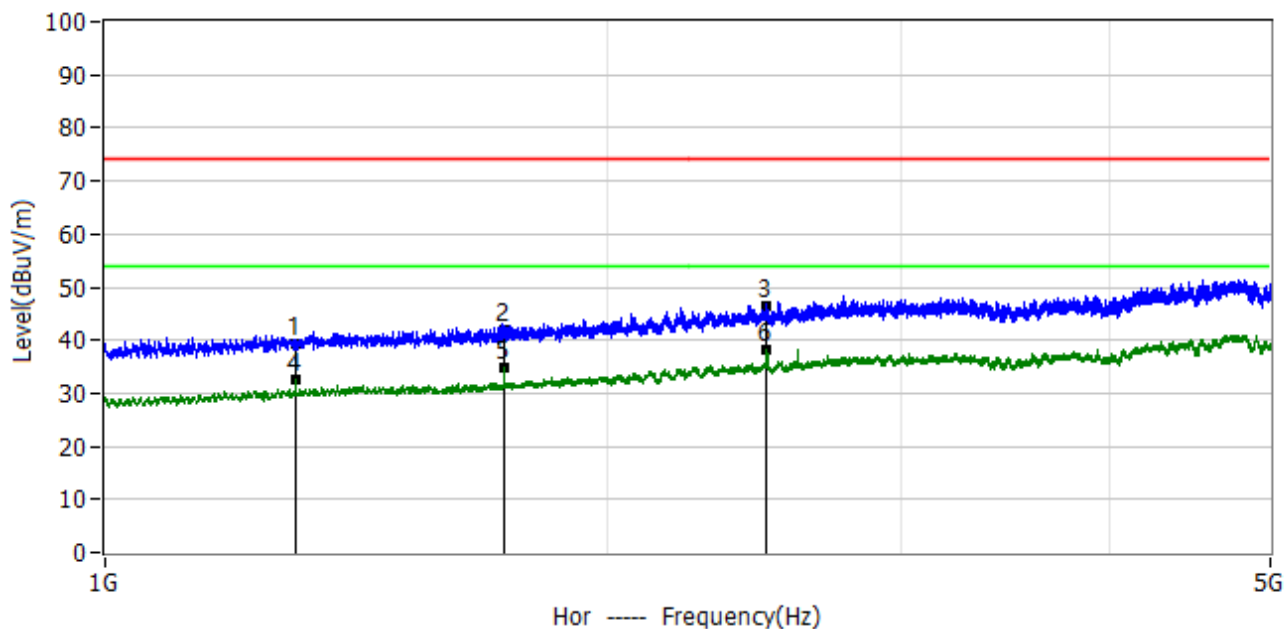

No.	Frequency	Reading dBuV	Factor dB/m	Level dBuV/m	Limit dBuV/m	Margin dB	Detector	Polar
1*	1.302GHz	61.66	-22.16	39.50	74.00	-34.50	PK	Hor
2*	1.736GHz	60.87	-18.87	42.00	74.00	-32.00	PK	Hor
3*	2.495GHz	57.44	-11.04	46.40	74.00	-27.60	PK	Hor
4*	1.302GHz	54.66	-22.16	32.50	54.00	-21.50	AV	Hor
5*	1.736GHz	53.68	-18.87	34.81	54.00	-19.19	AV	Hor
6*	2.495GHz	49.41	-11.04	38.37	54.00	-15.63	AV	Hor



Project: LGT22J052	Test Engineer: Dylan.shi
EUT: Maxtasy Stroke	Temperature: 25.2°C
M/N: MAXSTRPLUS	Humidity: 56%RH
Test Voltage: Battery	Test Data: 2022-11-29
Test Mode: 433M TX	
Note:	

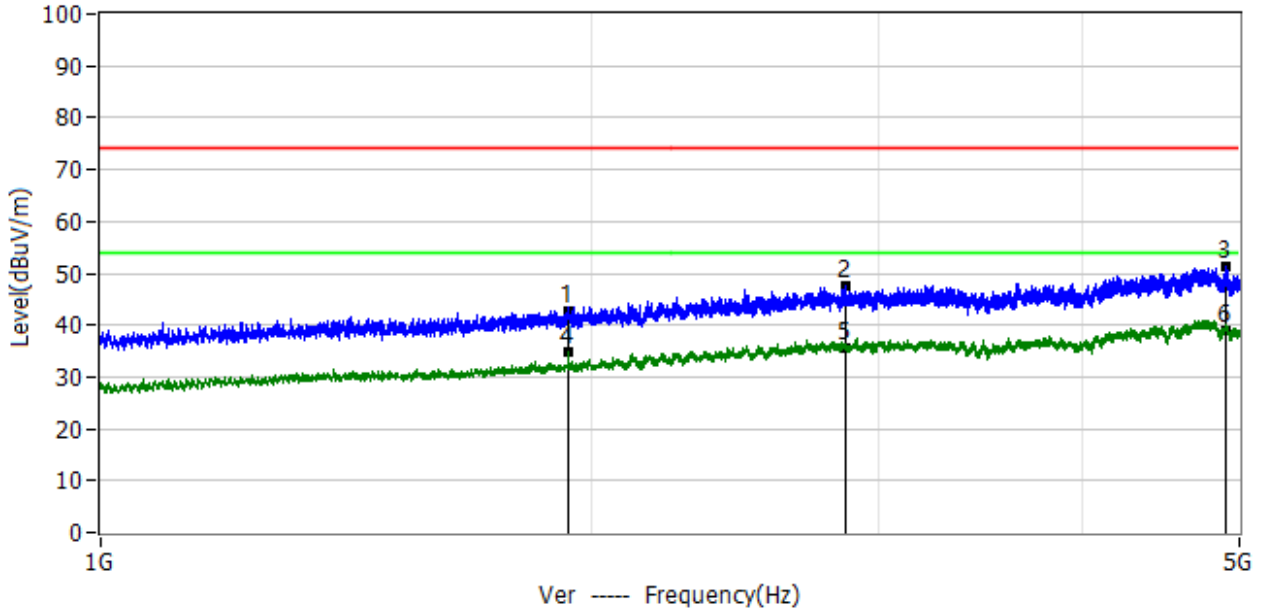

No.	Frequency	Reading dBuV	Factor dB/m	Level dBuV/m	Limit dBuV/m	Margin dB	Detector	Polar
1*	1.938GHz	59.66	-16.86	42.80	74.00	-31.20	PK	Ver
2*	2.868GHz	56.55	-9.04	47.51	74.00	-26.49	PK	Ver
3*	4.910GHz	57.51	-6.07	51.44	74.00	-22.56	PK	Ver
4*	1.938GHz	51.80	-16.86	34.94	54.00	-19.06	AV	Ver
5*	2.868GHz	44.54	-9.04	35.50	54.00	-18.50	AV	Ver
6*	4.910GHz	45.07	-6.07	39.00	54.00	-15.00	AV	Ver



5. BANDWIDTH TEST

5.1 LIMIT

FCC Part15.231,Subpart C			
Section	Test Item	Limit	Result
15.231(C)	20 Bandwidth	The20dB bandwidth of the emissions shall not exceed 0.25% of the center frequency	PASS

Spectrum Parameter	Setting
Attenuation	Auto
Span Frequency	> Measurement Bandwidth
RB	10 kHz (20dB Bandwidth)
VB	30 kHz (20dB Bandwidth)
Detector	Peak
Trace	Max Hold
Sweep Time	Auto

5.2 TEST REQUIREMENTS

The bandwidth of the emission shall be no wider than 0.25% of the center frequency for devices operating above 70 MHz and below 900 MHz. For devices operating above 900 MHz, the emission shall be no wider than 0.5% of the center frequency. Bandwidth is determined at the points 20 dB down from the modulated carrier.

5.3 TEST PROCEDURE

- The EUT was directly connected to the spectrum analyzer and antenna output port as show in the block diagram below.
- Spectrum Setting: RBW= 10KHz, VBW=30KHz, Sweep time = Auto.

5.4 TEST SETUP



5.5 EUT OPERATION CONDITIONS

TX mode.

5.6 TEST RESULTS



Centre Frequency (MHz)	20dB Bandwidth (KHz)	Limit (MHz)	Result
433.925	6.05	1.0848125	Pass

433.925MHz

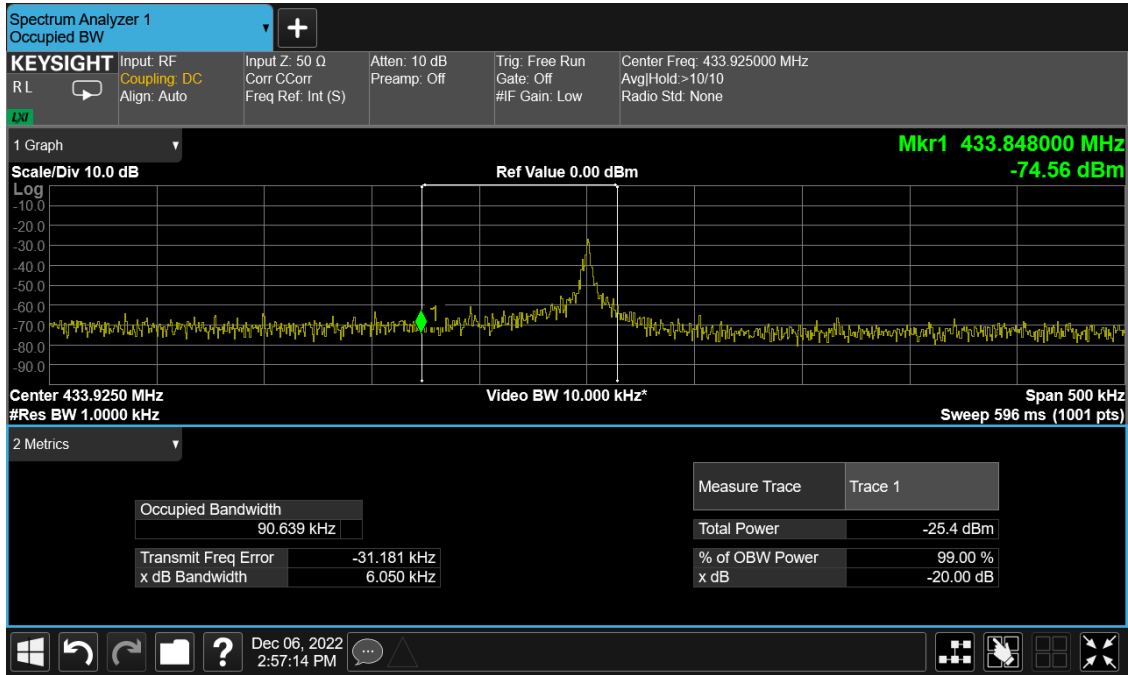



6. DUTY CYCLE

6.1 TEST PROCEDURE

The EUT was directly connected to the spectrum analyzer and antenna output port as show in the block diagram below.

The Duty Cycle Was Determined By The Following Equation: To Calculate The Actual Field Intensity,The Duty Cycle Correction Factor In Decibel Is Needed For Later Use And Can Be Obtained From Following Conversion

Duty Cycle(%)=Total On Interval In A Complete Pulse Train/ Length Of A Complete Pulse Train * %

Duty Cycle Correction Factor(Db)=20 * Log10(Duty Cycle(%))

6.2 TEST SETUP



6.3 EUT OPERATION CONDITIONS

TX mode.



6.4 TEST RESULTS

On time (ms)	21.9
Pulse period (ms)	51.2
Duty Cycle (%)	42.77%
PDCF	-7.38

Refer to the duty cycle plot (as below), This device meets the FCC requirement. Length of a complete pulse train

Remark:FCC part15.35(c) required that a complete pulse train is more than 0.1 seconds, the measured field strength shall be determined from the average absolute voltage during a 0.1 second interval during which the field strength is at its maximum value.

Note:

Number of pulse train 1 = 1, Time of single pulse train 1 = 6.2ms;

Number of pulse train 2 = 8, Time of single pulse train 2 = 1.4ms;

Number of pulse train 3 = 9, Time of single pulse train 3 = 0.5ms;

Total on interval in a complete pulse train= Number of pulse train 1 x Time of single pulse train 1+ Number of pulse train 2 x Time of single pulse train 2+ Number of pulse train 2 x Time of single pulse train 2=1x6.2+1.4x8+0.5x9=21.9ms



Pulse time

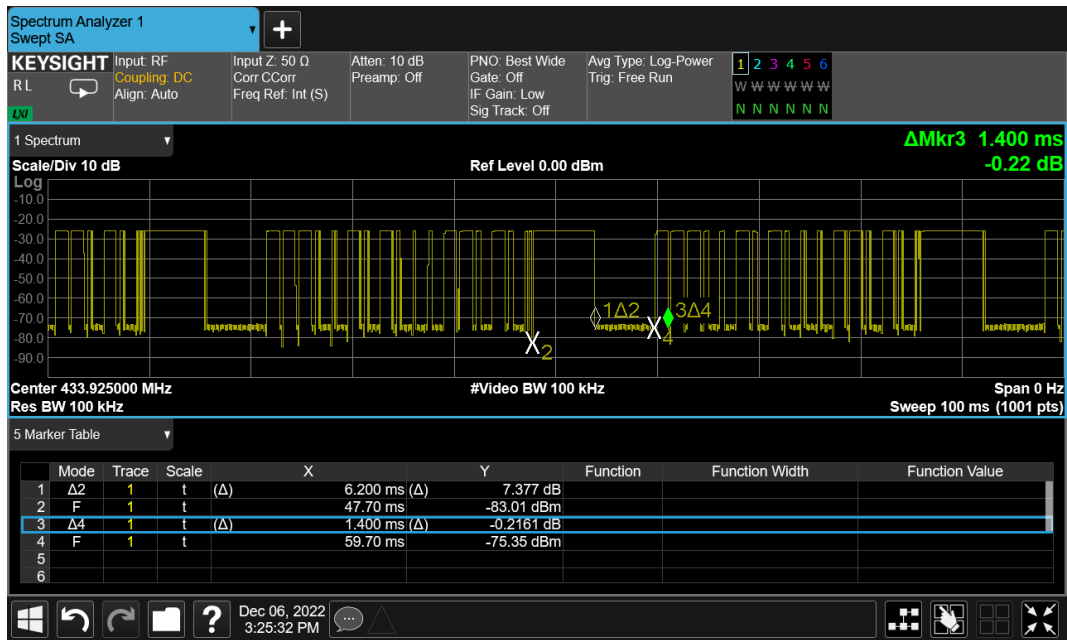

Pulse cycle

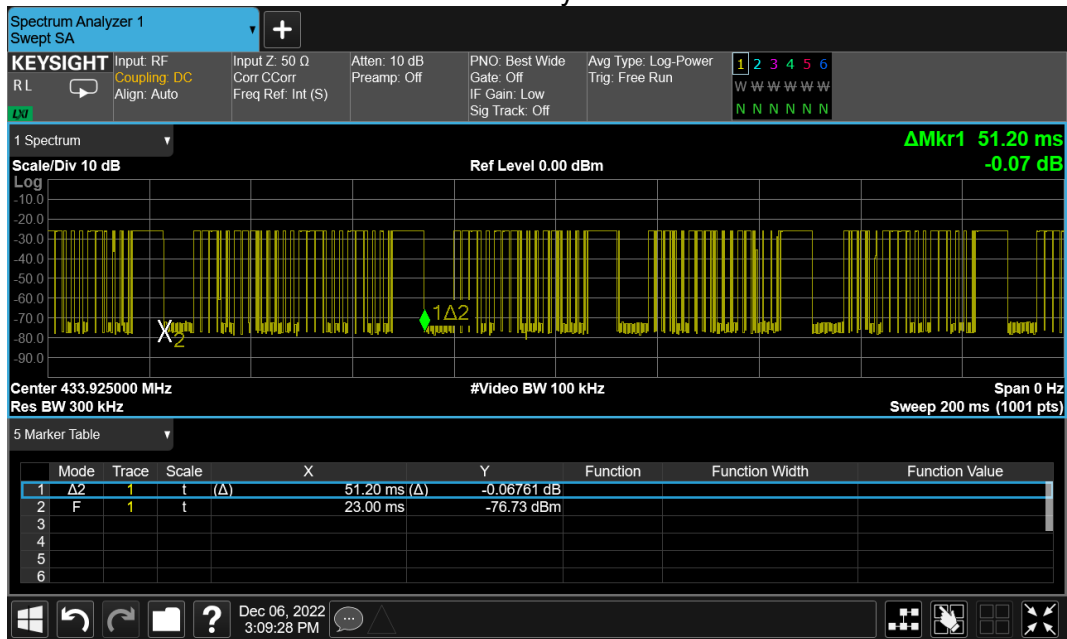



7. AUTOMATICALLY DEACTIVATE

7.1 STANDARD REQUIREMENT

A manually operated transmitter shall employ a switch that will automatically deactivate the transmitter within not more than 5 seconds of being released.

7.2 TEST PROCEDURE

The EUT was directly connected to the spectrum analyzer and antenna output port as show in the block diagram below.

Spectrum Setting : RBW= 100KHz, VBW=300KHz, Sweep time = Auto.

Note: Only press launch about 0.15 s

Note:

(1)Refer to the plot (As Below),We find a manually operated transmitter shall employ a switch that will automatically deactivate the transmitteri immediatly, within not more than 5 seconds of being released.

(2)The EUT is comply with FCC PART 15 clause 15.231(a)(1) manually working mode are pre-tested and only the worst result is reported.

7.3 TEST SETUP





7.4 TEST RESULTS

Centre Frequency (MHz)	Transmission time (S)	Limit (S)	Result
433.925	0.52	5	Pass

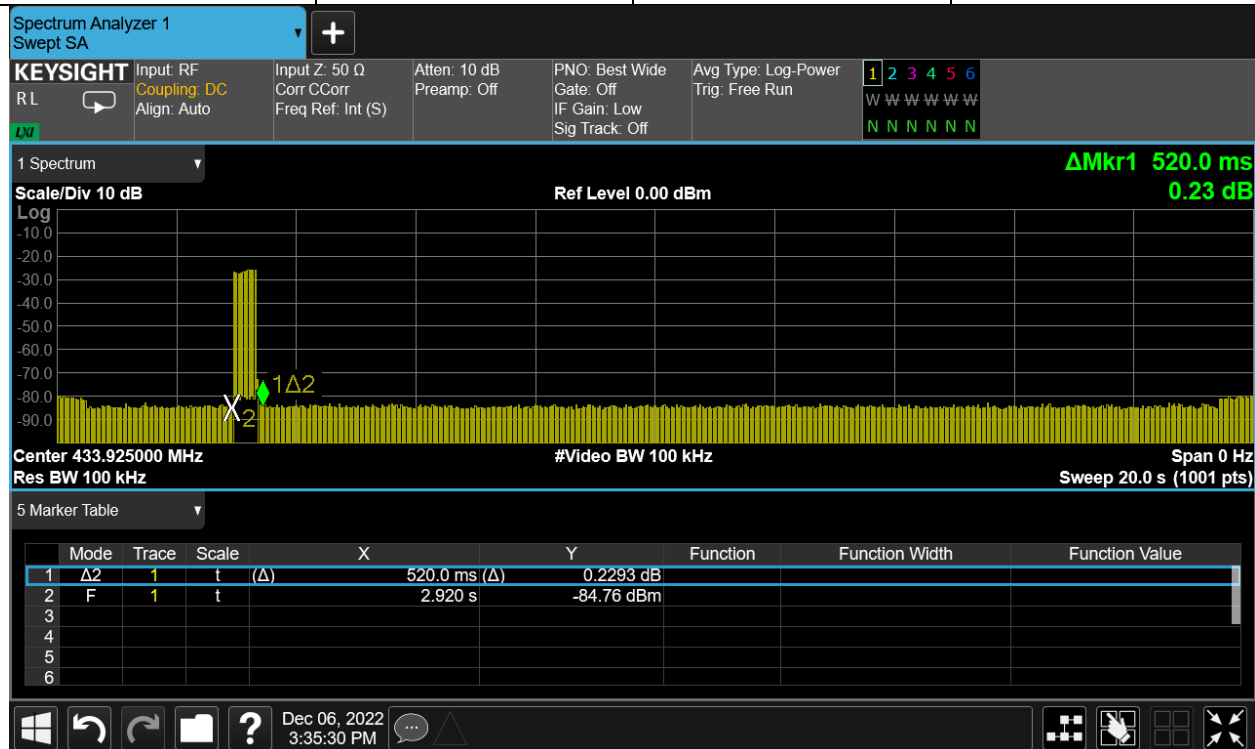



8. ANTENNA REQUIREMENT

8.1 STANDARD REQUIREMENT

According to the FCC Part 15 Paragraph 15.203, an intentional radiator shall be designed to ensure that no antenna other than that furnished by the responsible party shall be used with the device. The use of a permanently attached antenna to the intentional radiator shall be considered sufficient to comply with the provisions of this section.

8.2 EUT ANTENNA

The EUT antenna is PCB Antenna.It conforms to the standard requirements.



APPENDIX I - PHOTOS OF TEST SETUP

Note: See test photos in setup photo document for the actual connections between Product and support equipment.

*****END OF THE REPORT*****