



RADIO TEST REPORT

Report No.: SHATBL2210011W01

Applicant:

Zhejiang General Light Curtain Co.,LTD.

Address:

Xin Tang Tou Village, Xin Jie Town, Xiao Shan District,
HangZhou City, Zhe Jiang Province, China

Product Name : Remote Control

Brand Name : **POYAL**

Model Name : PEM105

Series Model : N/A

FCC ID : 2A839-PEM105

Test Standard : FCC Part 15.231

"Shanghai ATBL Technology Co., Ltd." hereby certifies that according to actual testing conditions. The test results or observations are provided in accordance with measured value, without taking risks caused by uncertainty into account. Without explicit stipulation in special agreements, standards or regulations, ATBL shall not assume any responsibility. The test results or observations are applicable only to tested sample. Client shall be responsible for representativeness of the sample and authenticity of the material. This report will be void without authorized signature or special seal for testing report. Do not copied without authorization.

Tel:+86(0)21-51298625

Web:www.atbl-lab.com

Email:atbl@atbl-lab.com

GENERAL DESCRIPTION

Applicant's Name.....: Zhejiang General Light Curtain Co.,LTD.
Address.....: Xin Tang Tou Village, Xin Jie Town, Xiao Shan District,
Hangzhou City, Zhe Jiang Province, China
Manufacture's Name.....: Zhejiang General Light Curtain Co.,LTD.
Address.....: Xin Tang Tou Village, Xin Jie Town, Xiao Shan District,
Hangzhou City, Zhe Jiang Province, China

Product Description

Product Name.....: Remote Control
Brand Name.....: **POYAL**
Model Name.....: PEM105
SeriesModel.....: N/A

Test Standards.....: FCC Part 15.231
Test Procedure.....: ANSI C63.10-2013

This device described above has been tested by ATBL, the test results show that the equipment under test (EUT) is in compliance with the FCC requirements. And it is applicable only to the tested sample identified in the report.

This report shall not be reproduced except in full, without the written approval of ATBL, this document may be altered or revised by ATBL, personal only, and shall be noted in the revision of the document.

Date of receipt of test item.....: 2022.10.18
Date (s) of performance of tests.....: 2022.11.23-2022.11.24
Date of Issue.....: 2022.11.23
Test Result.....: **Pass**

Testing Engineer :



(Chris Xu / Jack Suo)

Technical Manager :



(Ghost Li)

Authorized Signatory :

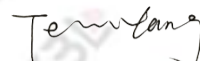

(Terry Yang)



Table of Contents

1. SUMMARY OF TEST RESULTS	6
2. GENERAL INFORMATION	7
2.1 GENERAL DESCRIPTION OF THE EUT	7
2.2 DESCRIPTION OF THE TEST MODES	8
2.3 BLOCK DIAGRAM SHOWING THE CONFIGURATION OF SYSTEM TESTED	8
2.4 DESCRIPTION OF NECESSARY ACCESSORIES AND SUPPORT UNITS	9
2.5 LABORATORY INFORMATION	9
2.6 MEASUREMENT UNCERTAINTY	9
2.7 EQUIPMENTS LIST	10
3. EMC EMISSION TEST	12
3.1 CONDUCTED EMISSION MEASUREMENT	12
3.2 TEST PROCEDURE	12
3.3 TEST SETUP	13
3.4 EUT OPERATING CONDITIONS	13
3.5 TEST RESULTS	13
4. RADIATED EMISSION MEASUREMENT	14
4.1 RADIATED EMISSION LIMITS	14
4.2 TEST PROCEDURE	16
4.3 TEST SETUP	17
4.4 EUT OPERATING CONDITIONS	17
4.5 FIELD STRENGTH CALCULATION	18
5. BANDWIDTH TEST	24
5.1 LIMIT	24
5.2 TEST SETUP	24
5.3 EUT OPERATION CONDITIONS	24
5.4 TEST RESULTS	25
6. DUTY CYCLE	26
6.1 TEST PROCEDURE	26
6.2 TEST SETUP	26
6.3 EUT OPERATION CONDITIONS	26
6.4 TEST RESULTS	27
7. AUTOMATICALLY DEACTIVATE	28

Table of Contents

7.1 STANDARD REQUIREMENT	28
7.2 TEST PROCEDURE	28
7.3 TEST SETUP	28
7.4 TEST RESULTS	29
8. ANTENNA REQUIREMENT	30
8.1 STANDARD REQUIREMENT	30
8.2 EUT ANTENNA	30
APPENDIX-PHOTOS OF TEST SETUP	31

Revision History

Rev.	Issue Date	Report NO.	Effect Page	Contents
00	2022-11-27	SHATBL2210011W01	ALL	Initial Issue

1. SUMMARY OF TEST RESULTS

Test procedures according to the technical standards:

FCC Part 15.231,Subpart C			
Standard Section	Test Item	Judgment	Remark
15.207	Conducted Emission	N/A	--
15.205(a)/15.209/ 15.231.(b)	Radiated Spurious Emission	PASS	--
15.231(a)(1)	Transmission requirement	PASS	--
15.231(C)	20 dB Bandwidth	PASS	--
15.203	Antenna Requirement	PASS	--

NOTE:

(1) 'N/A' denotes test is not applicable in this Test Report.

(2)All tests are according to ANSI C63.10-2013.

2. GENERAL INFORMATION

2.1 GENERAL DESCRIPTION OF THE EUT

Product Name	Remote Control
Trade Name	POYAL
Model Name	PEM105
Series Model	N/A
Model Difference	N/A
Frequency band	433.92 MHz
Rating	Input: DC 3V
Modulation Type	OOK
Hardware version number	V4.0
Software version number	V1.0
Connecting I/O Port(s)	N/A

Note:

- For a more detailed features description, please refer to the manufacturer's specifications or the User Manual.

Ant.	Brand	Model Name	Antenna Type	Connector	Gain (dBi)	NOTE
1	N/A	N/A	PCB antenna	N/A	-4.8	Antenna

2.2 DESCRIPTION OF THE TEST MODES

For conducted test items and radiated spurious emissions
 Each of these EUT operation mode(s) or test configuration mode(s) mentioned below was evaluated respectively.

Pretest Mode	Description
Mode 1	TX Mode

Note:

(1) The measurements are performed at all Bit Rate of Transmitter, the worst data was reported.

For Conducted Emission

Test Case	
Conducted Emission	TX Mode

2.3 BLOCK DIAGRAM SHOWING THE CONFIGURATION OF SYSTEM TESTED

During test, Keep EUT is in continuous transmission mode, Both open button and closed button have been tested, The two keys were tested to assess and only record the worst case in the report (Open button).

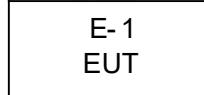

2.4 DESCRIPTION OF NECESSARY ACCESSORIES AND SUPPORT UNITS

The EUT has been tested as an independent unit together with other necessary accessories or support units. The following support units or accessories were used to form a representative test configuration during the tests.

Necessary accessories

Item	Equipment	Mfr/Brand	Model/Type No.	Length	Note
N/A	N/A	N/A	N/A	N/A	N/A

Support units

Item	Equipment	Mfr/Brand	Model	Type No.	Note
N/A	N/A	N/A	N/A	N/A	N/A

Note:

- (1) The support equipment was authorized by Declaration of Confirmation.
- (2) For detachable type I/O cable should be specified the length in cm in 『Length』 column.

2.5 LABORATORY INFORMATION

Company Name:	Shanghai ATBL Technology Co., Ltd.
Address:	Building 8, No. 160, Basheng Road, Waigaoqiao Free Trade Zone, Pudong New Area, Shanghai
Telephone:	+86(0)21-51298625
The FCC Registration Number (FRN):	0031025281
A2LA Number:	6184.01
CNAS Number:	CNAS L14531

2.6 MEASUREMENT UNCERTAINTY

The reported uncertainty of measurement $y \pm U$, where expanded uncertainty U is based on a standard uncertainty multiplied by a coverage factor of $k=2$, providing a level of confidence of approximately **95 %**.

No.	Item	Uncertainty
1	RF output power, conducted	$\pm 0.68\text{dB}$
2	Unwanted Emissions, conducted	$\pm 2.988\text{dB}$
3	All emissions, radiated 9K-30MHz	$\pm 2.84\text{dB}$
4	All emissions, radiated 30M- 1GHz	$\pm 4.39\text{dB}$
5	All emissions, radiated 1G-6GHz	$\pm 5.10\text{dB}$
6	All emissions, radiated >6G	$\pm 5.48\text{dB}$
7	Conducted Emission (9kHz- 150kHz)	$\pm 2.79\text{dB}$
8	Conducted Emission (150kHz-30MHz)	$\pm 2.80\text{dB}$

2.7 EQUIPMENTS LIST

2.7.1 Radiation Test equipment

kind of Equipment	Manufacturer	Type No.	Serial No.	Management number	Calibrated until
Test Receiver	R&S	ESCI	100469	SHATBL-E003	2023.05.20
Spectrum Analyzer	Agilent	N9020A	MY50200811	SHATBL-E017	2023.05.20
Bilog Antenna	SCHWARZBECK	VLUB 9168	01174	SHATBL-E008	2023.05.20
Horn Antenna	SCHWARZBECK	BBHA 9120D	02014	SHATBL-E009	2023.05.20
Pre-Amplifier (0.1M-3GHz)	JPT	JPA-10M1G35	21010100035001	SHATBL-E005	2023.05.20
Pre-Amplifier (1G-18GHz)	JPT	JPA0118-55-303A	1910001800055000	SHATBL-E006	2023.05.20
Temperature & Humidity	DeLi	DeLi	N/A	SHATBL-E016	2023.05.20
Antenna/Turntable Controller	Brilliant	N/A	N/A	SHATBL-E007	N/A
Test SW	FALA	EMC-RI(Ver.4A2)		SHATBL-E046	N/A

2.7.2 Conduction Test equipment

kind of Equipment	Manufacturer	Type No.	Serial No.	Management number	Calibration date
Test Receiver	R&S	ESPI	101679	SHATBL-E012	2023.05.20
LISN	R&S	ENV216	101300	SHATBL-E013	2023.05.20
LISN	R&S	ENV216	100333	SHATBL-E041	2023.05.20
Temperature & Humidity	DeLi	DeLi	N/A	SHATBL-E015	2023.05.20
Test SW	FALA	EZ-EMC(Ver.EMC-CON3A1.1)		SHATBL-E044	N/A

2.7.3 RF Connected Test

kind of Equipment	Manufacturer	Type No.	Serial No.	equipment number	Calibrated until
Power meter (with pulse power sensor)	Anritsu	ML2496A	1935001	SHATBL-W030	2023.9.27
Pulse power sensor (with power meter)	Anritsu	MA2411B	1911006	SHATBL-W031	2023.9.27
Signal Analyzer	Agilent	N9020A	MY57300196	SHATBL-W004	2023.9.27
Signal Generator	Agilent	N5182B	MY46240556	SHATBL-W005	2023.9.27
Wireless Communications Test Set	R&S	CMW500	101331	SHATBL-W007	2023.9.27
Temperature & Humidity	Deli	deli	N/A	SHATBL-W011	2023.9.27
Attenuator	Agilent	8494B	DC-18G	SHATBL-W009	2023.9.27
Attenuator	Agilent	8496B	DC-18G	SHATBL-W010	2023.9.27
power splitter	MNk	MPD-DC/6-2 S	62315 G51	SHATBL-W015	2023.9.27
			62315 G52	SHATBL-W016	2023.9.27
Filter	Chengdu kangmaiwei	ZBSF-C2400 -2483.5-T3	N/A	SHATBL-W021	N/A
Constant temperature and humidity box	kSON	THS-B6C-150	6159k	SHATBL-W019	2023.01.17
Test SW	FALA	LZ-RF(Ver.LzRF-03A3.1)		SHATBL-W020	N/A

3. EMC EMISSION TEST

3.1 CONDUCTED EMISSION MEASUREMENT

3.1.1 POWER LINE CONDUCTED EMISSION LIMITS

The radio frequency voltage that is conducted back onto the AC power line on any frequency or frequencies, within the band 150 kHz to 30 MHz, shall not exceed the limits in the following table .

FREQUENCY (MHz)	Class B (dBuV)		Standard
	Quasi- peak	Average	
0.15 -0.5	66 - 56 *	56 - 46 *	CISPR
0.50 -5.0	56.00	46.00	CISPR
5.0 -30.0	60.00	50.00	CISPR

0.15 -0.5	66 - 56 *	56 - 46 *	FCC
0.50 -5.0	56.00	46.00	FCC
5.0 -30.0	60.00	50.00	FCC

Note:

- (1) The tighter limit applies at the band edges.
- (2) The limit of “ * ” marked band means the limitation decreases linearly with the logarithm of the frequency in the range.

The following table is the setting of the receiver

Receiver Parameters	Setting
Attenuation	10 dB
Start Frequency	0.15 MHz
Stop Frequency	30 MHz
IF Bandwidth	9 kHz

3.2 TEST PROCEDURE

- a. The EUT is 0.8 m from the horizontal ground plane and 0.4 m from the vertical ground plane with EUT being connected to the power mains through a line impedance stabilization network (LISN). All other support equipments are powered from additional LISN(s). The LISN provides 50 Ohm/ 50uH of coupling impedance for the measuring instrument.
- b. Interconnecting cables that hang closer than 40 cm to the ground plane shall be folded back and forth in the center forming a bundle 30 to 40 cm long.
- c. I/O cables that are not connected to a peripheral shall be bundled in the center. The end of the cable may be terminated, if required, using the correct terminating impedance. The overall length shall not exceed 1 m.
- d. LISN is at least 80 cm from the nearest part of EUT chassis.
- e. For the actual test configuration, please refer to the related Item –EUT Test Photos.

3.3 TEST SETUP

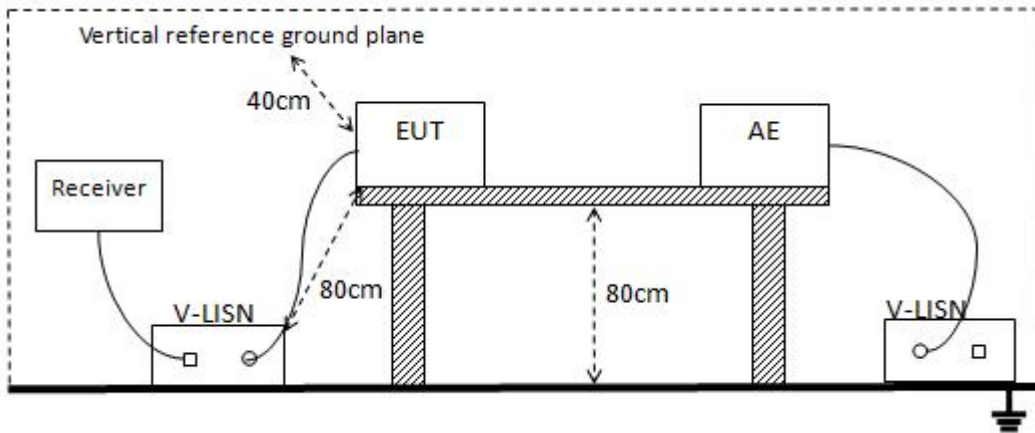

3.4 EUT OPERATING CONDITIONS

The EUT was configured for testing in a typical fashion (as a customer would normally use it). The EUT has been programmed to continuously transmit during test. This operating condition was tested and used to collect the included data.

3.5 TEST RESULTS

Temperature:	N/A	Relative Humidity:	N/A
Test Voltage:	N/A	Phase :	L/N
Test Mode:	N/A		

Note: EUT is only power by battery, So it is not applicable for this test.

4. RADIATED EMISSION MEASUREMENT

4.1 RADIATED EMISSION LIMITS

In case the emission fall within the restricted band specified on Part 15.205(a), then the Part 15.209(a) and Part 15.231(b) limit in the table below has to be followed.

LIMITS OF RADIATED EMISSION MEASUREMENT (Frequency Range 9kHz-1000MHz)

Frequencies (MHz)	Field Strength (micровolts/meter)	Measurement Distance (meters)
0.009~0.490	2400/F(kHz)	300
0.490~1.705	24000/F(kHz)	30
1.705~30.0	30	30
30~40.66	100	3
40.70~70	100	3

Fundamental Frequency (MHz)	Field Strength of fundamental (microvolts/meter)	Field Strength of Unwanted Emissions (microvolts/meter)
40.66~40.70	2,250	225
70~130	1,250	125
130~174	1,250 to 3,750**	125 to 375**
174~260	3750	375
260~470	3,750 to 12,500**	375 to 1,250**
Above 470	12,500	1,250

LIMITS OF RADIATED EMISSION MEASUREMENT (Above 1000MHz)

FREQUENCY (MHz)	(dBuV/m) (at 3M)	
	PEAK	AVERAGE
Above 1000	74	54

Notes:

- (1) The limit for radiated test was performed according to FCC PART 15C.
- (2) The tighter limit applies at the band edges.
- (3) Emission level (dBuV/m)=20log Emission level (uV/m).

LIMITS OF RESTRICTED FREQUENCY BANDS

FREQUENCY (MHz)	FREQUENCY (MHz)	FREQUENCY (MHz)	FREQUENCY (GHz)
0.090-0.110	16.42-16.423	399.9-410	4.5-5.15
0.495-0.505	16.69475-16.69525	608-614	5.35-5.46
2.1735-2.1905	16.80425-16.80475	960-1240	7.25-7.75
4.125-4.128	25.5-25.67	1300-1427	8.025-8.5
4.17725-4.17775	37.5-38.25	1435-1626.5	9.0-9.2
4.20725-4.20775	73-74.6	1645.5-1646.5	9.3-9.5
6.215-6.218	74.8-75.2	1660-1710	10.6-12.7
6.26775-6.26825	108-121.94	1718.8-1722.2	13.25-13.4
6.31175-6.31225	123-138	2200-2300	14.47-14.5
8.291-8.294	149.9-150.05	2310-2390	15.35-16.2
8.362-8.366	156.52475-156.52525	2483.5-2500	17.7-21.4
8.37625-8.38675	156.7-156.9	2690-2900	22.01-23.12
8.41425-8.41475	162.0125-167.17	3260-3267	23.6-24.0
12.29-12.293	167.72-173.2	3332-3339	31.2-31.8
12.51975-12.52025	240-285	3345.8-3358	36.43-36.5
12.57675-12.57725	322-335.4	3600-4400	Above 38.6
13.36-13.41			

Spectrum Parameter	Setting
Detector	Peak
Attenuation	Auto
Start Frequency	1000 MHz
Stop Frequency	10th carrier harmonic
RB / VB (emission in restricted band)	1MHz / 3MHz

Receiver Parameter	Setting
Attenuation	Auto
Start ~ Stop Frequency	9kHz~90kHz / RB 200Hz for PK & AV
Start ~ Stop Frequency	90kHz~110kHz / RB 200Hz for QP
Start ~ Stop Frequency	110kHz~490kHz / RB 200Hz for PK & AV
Start ~ Stop Frequency	490kHz~30MHz / RB 9kHz for QP
Start ~ Stop Frequency	30MHz~1000MHz / RB 120kHz for QP

4.2 TEST PROCEDURE

- a. The measuring distance of at 3 m shall be used for measurements at frequency 0.009MHz up to 1GHz, and above 1GHz.
- b. The EUT was placed on the top of a rotating table 0.8 meters (above 1GHz is 1.5 m) above the ground at a 3 meter anechoic chamber. The table was rotated 360 degrees to determine the position of the highest radiation.
- c. The height of the equipment shall be 0.8 m (above 1GHz is 1.5 m); the height of the test antenna shall vary between 1 m to 4 m. Horizontal and vertical polarizations of the antenna are set to make the measurement.
- d. The initial step in collecting conducted emission data is a spectrum analyzer peak detector mode pre-scanning the measurement frequency range. Significant peaks are then marked and then Quasi Peak detector mode re-measured.
- e. If the Peak Mode measured value compliance with and lower than Quasi Peak Mode Limit, the EUT shall be deemed to meet QP Limits and then no additional QP Mode measurement performed.
- f. For the actual test configuration, please refer to the related Item –EUT Test Photos.

Note:

Both horizontal and vertical antenna polarities were tested and performed pretest to three orthogonal axis. The worst case emissions were reported.

4.3 TEST SETUP

(A) Radiated Emission Test-Up Frequency Below 30MHz

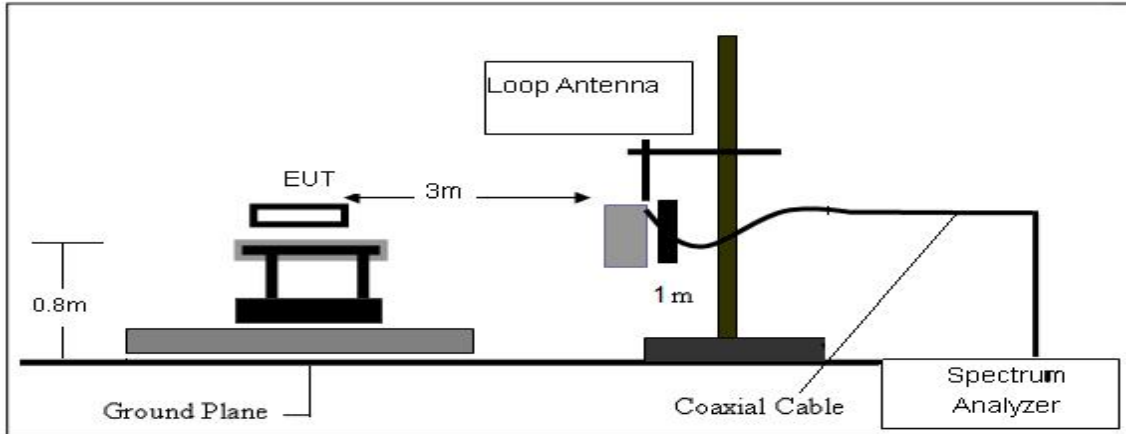

(B) Radiated Emission Test-Up Frequency 30MHz~1GHz

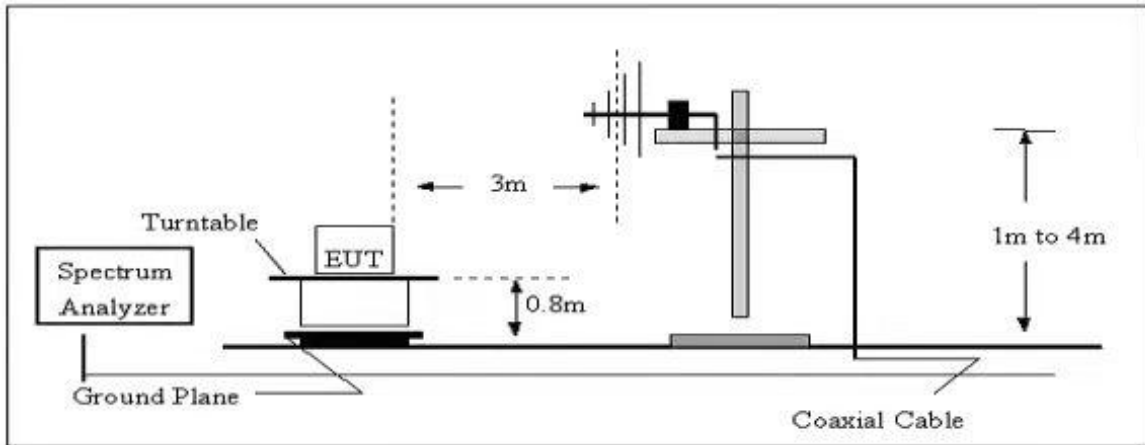

(C) Radiated Emission Test-Up Frequency Above 1GHz

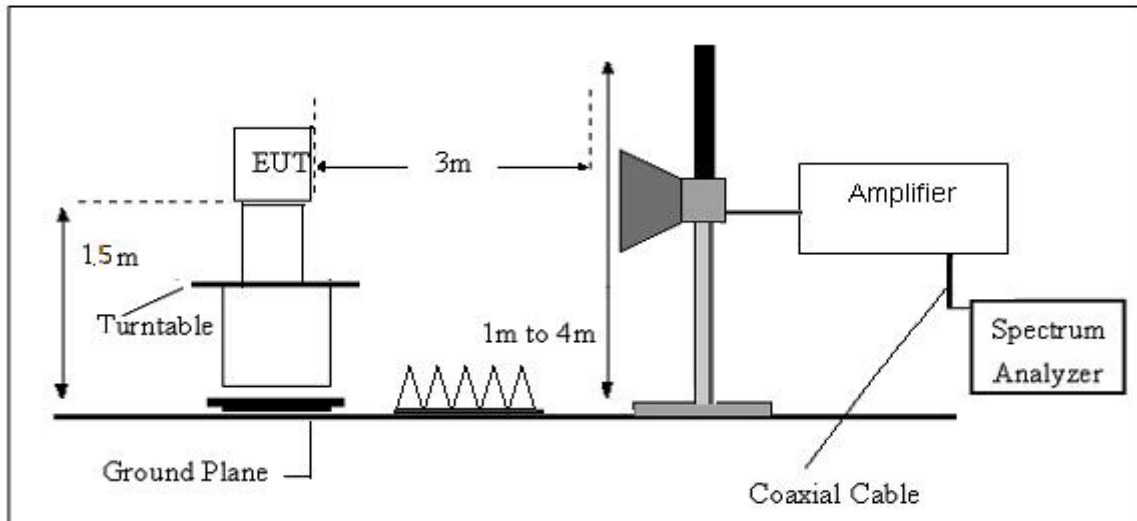

4.4 EUT OPERATING CONDITIONS

The EUT tested system was configured as the statements of 2.3 Unless otherwise a special operating condition is specified in the follows during the testing.

4.5 FIELD STRENGTH CALCULATION

The field strength is calculated by adding the Antenna Factor and Cable Factor and subtracting the Amplifier Gain and Duty Cycle Correction Factor (if any) from the measured reading. The basic equation with a sample calculation is as follows:

$$FS = RA + AF + CL - AG$$

Where

FS = Field Strength

CL = Cable Attenuation Factor (Cable Loss)

RA = Reading Amplitude

AG = Amplifier Gain

AF = Antenna Factor

For example

Frequency (MHz)	FS (dB μ V/m)	RA (dB μ V/m)	AF (dB)	CL (dB)	AG (dB)	Factor (dB)
300	40	58.1	12.2	1.6	31.9	-18.1

$$\text{Factor} = \text{AF} + \text{CL} - \text{AG}$$

4.6 TEST RESULTS

(Radiated Emission < 30 MHz (9 kHz - 30 MHz, H-field))

Freq.	Reading	Limit	Margin	State
(MHz)	(dBuV/m)	(dBuV/m)	(dB)	P/F
--	--	--	--	PASS
--	--	--	--	PASS

Note:

The amplitude of spurious emissions which are attenuated by more than 20 dB below the permissible value has no need to be reported.

Distance extrapolation factor = $40 \log(\text{specific distance}/\text{test distance})$ (dB);

Limit line = specific limits (dBuV) + distance extrapolation factor.

(30MHz -1000MHz)

Temperature:	23.3°C	Relative Humidity:	60%RH
Test Voltage:	DC 3V	Phase:	Horizontal
Test Mode:	TX Mode 1		

Remark:

1. Margin = Result (Result =Reading + Factor)–Limit
2. Factor= Antenna factor+Cable attenuation factor(cable loss)-Amplifier gain

Mode 1 Horizontal

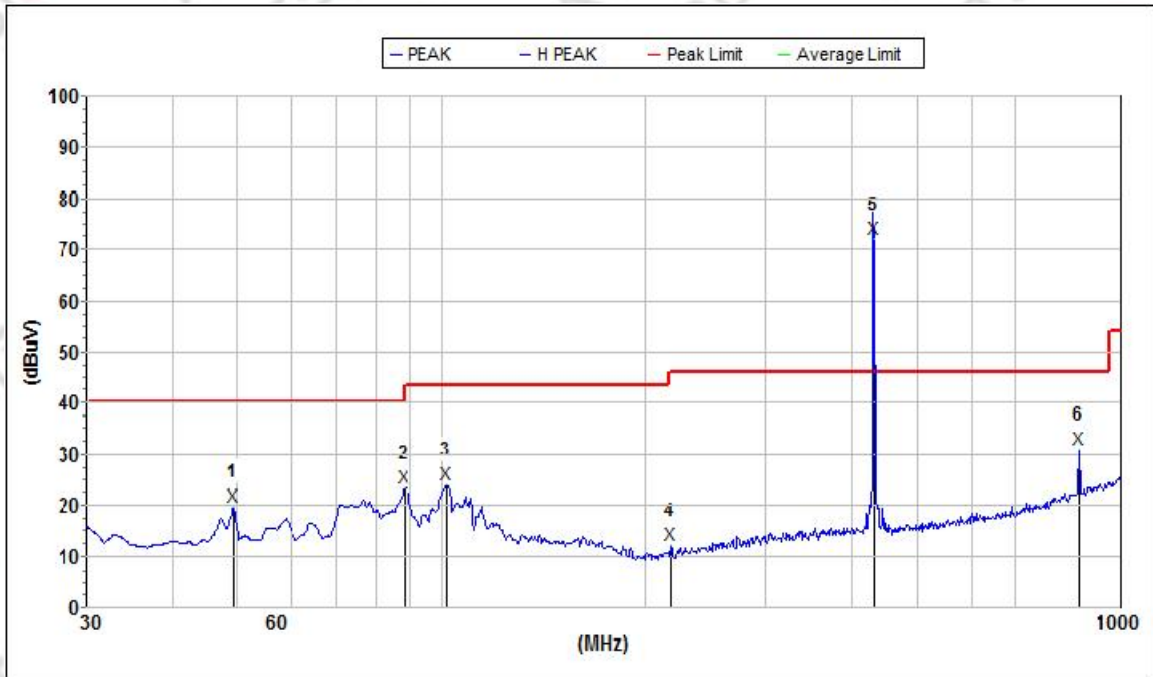

Mk.	Freq.(MHz)	Level(dBu V/m)	Limit(dB uV/m)	Margin (dB)	Ant.F/G.(dB/m)	Amp.G.(dB)	Cbl.L.(dB)	Pol.
1	49.359	19.8	40.0	20.2	13.6	32.6	0.8	H
2	88.033	23.4	43.5	20.1	9.4	32.9	1.1	H
3	101.644	24.1	43.5	19.4	10.3	32.9	1.4	H
4	217.544	12.1	46.0	33.9	10.5	32.8	2.4	H
5	433.920	71.9	80.8	8.9	14.2	32.4	2.7	H
6	866.088	30.8	46.0	15.2	19.5	31.8	3.6	H

Temperature:	23.3°C	Relative Humidity:	60%RH
Test Voltage:	DC 3V	Phase:	Vertical
Test Mode:	TX Mode 1		

Remark:

- Margin = Result (Result = Reading + Factor) – Limit
- Factor = Antenna factor + Cable attenuation factor (cable loss) – Amplifier gain

Mode 1 Vertical

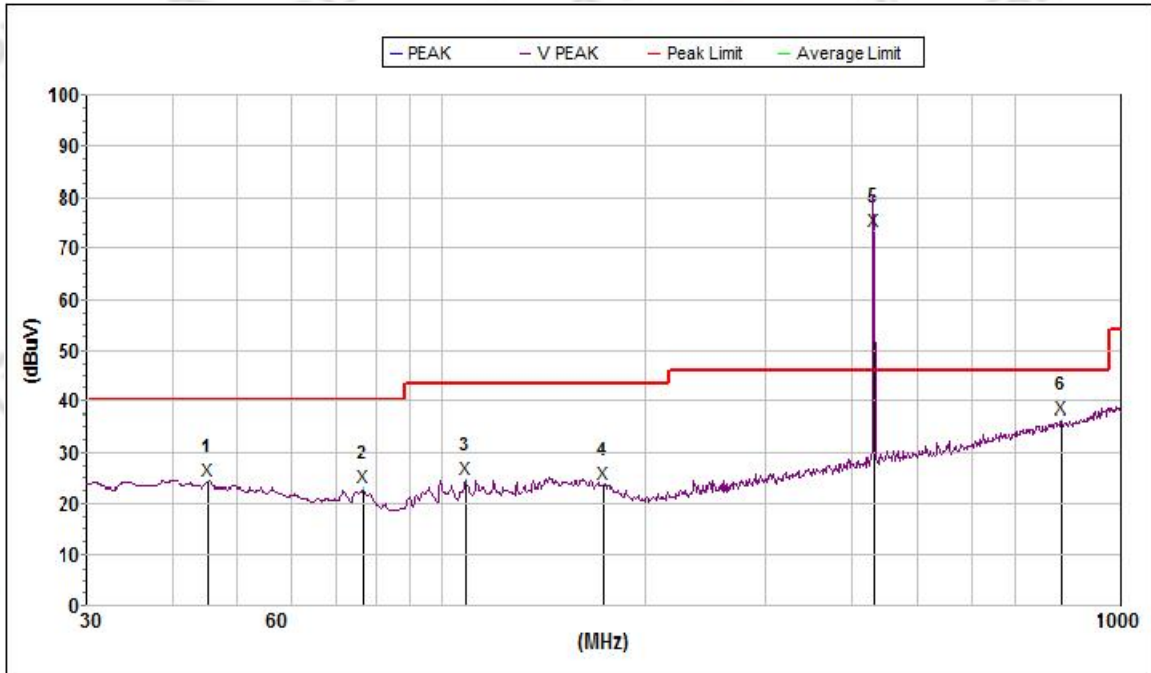

Mk.	Freq.(MHz)	Level(d BuV/m)	Limit(dB uV/m)	Margin (dB)	Ant.F/G.(dB/m)	Amp.G.(dB)	Cbl.L.(dB)	Pol.
1	45.375	24.5	40.0	15.5	13.8	32.5	0.8	V
2	76.512	22.9	40.0	17.1	9.8	32.9	0.9	V
3	108.267	24.7	43.5	18.8	11.0	32.9	1.4	V
4	172.599	23.6	43.5	19.9	12.8	32.8	1.8	V
5	433.920	73.5	80.8	7.3	15.6	32.4	2.7	V
6	815.968	36.5	46.0	9.5	20.8	32.1	3.6	V

(1000MHz -5000MHz)

Temperature:	23.3°C	Relative Humidity:	60%RH
Test Voltage:	DC 3V	Phase:	Horizontal
Test Mode:	TX Mode 1		

Remark:

1. Margin = Result (Result =Reading + Factor)–Limit
2. Factor= Antenna factor+Cable attenuation factor(cable loss)-Amplifier gain

Mode 1 Horizontal

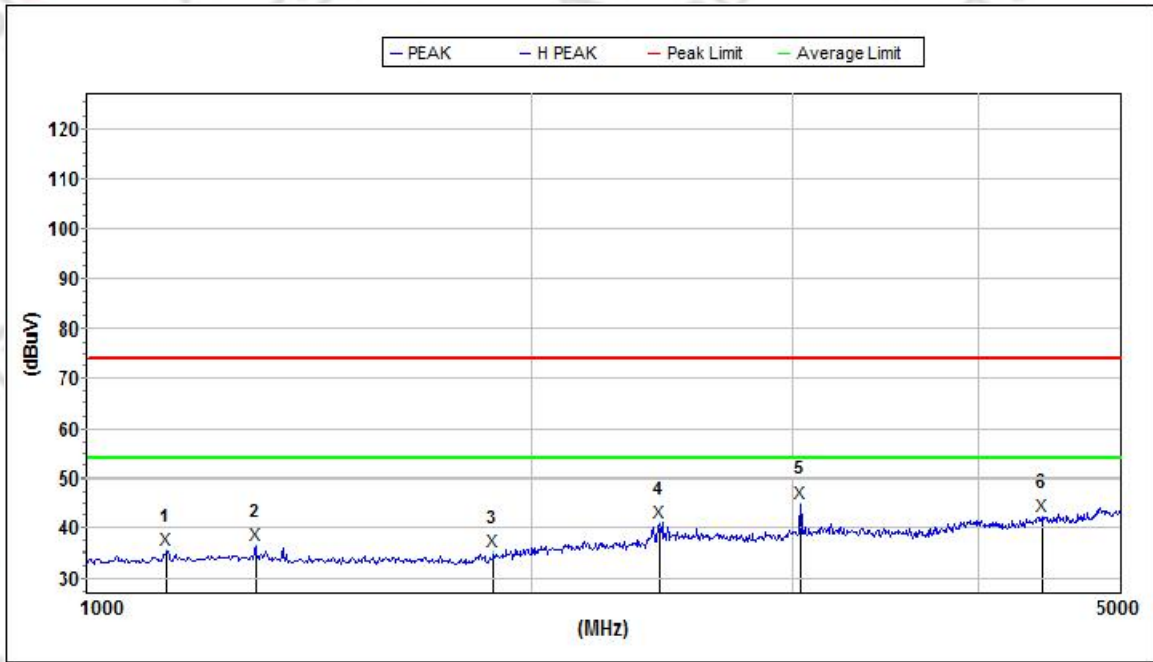

Mk.	Freq.(MHz)	Level(d BuV/m)	Limit(dB uV/m)	Margin (dB)	Ant.F/G.(dB/m)	Amp.G.(dB)	Cbl.L .(dB)	Pol.
1	1131.932919	35.4	74.0	38.6	25.6	60.7	2.2	H
2	1299.966350	36.5	74.0	37.5	25.8	61.1	2.3	H
3	1882.327606	35.1	74.0	38.9	25.5	61.0	2.6	H
4	2439.098743	41.0	74.0	33.0	27.5	59.2	2.8	H
5	3035.912868	45.1	74.0	28.9	29.5	58.8	3.0	H
6	4417.222890	42.4	74.0	31.6	31.6	58.0	3.5	H

Temperature:	23.3°C	Relative Humidity:	60%RH
Test Voltage:	DC 3V	Phase:	Vertical
Test Mode:	TX Mode 1		

Remark:

1. Margin = Result (Result =Reading + Factor)–Limit
2. Factor= Antenna factor+Cable attenuation factor(cable loss)-Amplifier gain

Mode 1 Vertical

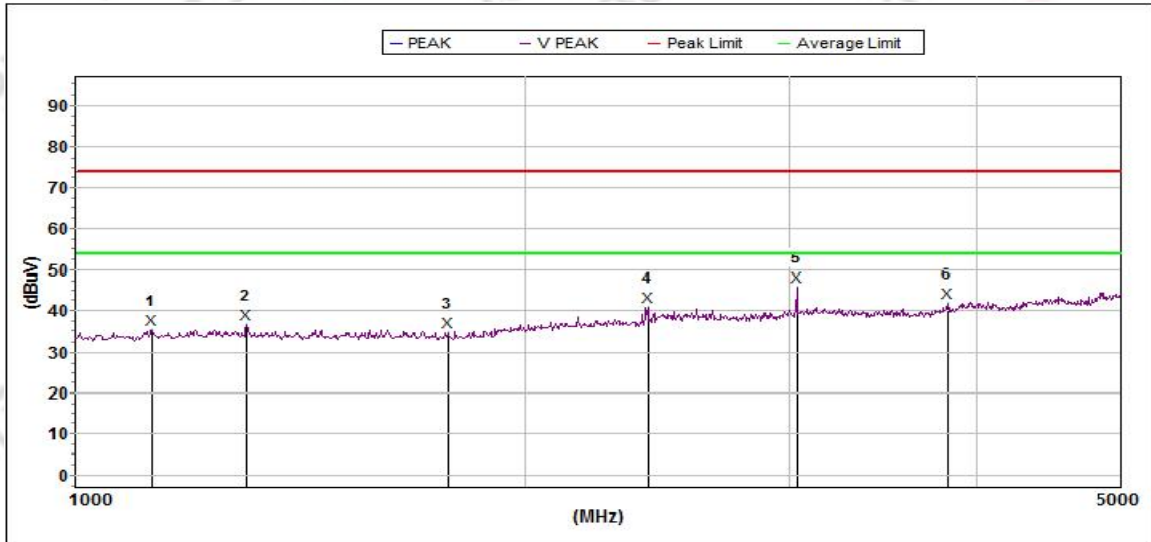

Mk.	Freq.(MHz)	Level(d BuV/m)	Limit(dB uV/m)	Margin (dB)	Ant.F/G.(dB/m)	Amp.G.(dB)	Cbl.L (.dB)	Pol.
1	1122.860593	35.4	74.0	38.6	25.5	60.6	2.2	V
2	1299.966350	36.7	74.0	37.3	25.8	61.1	2.3	V
3	1773.508693	34.7	74.0	39.3	25.1	61.3	2.6	V
4	2415.658634	41.2	74.0	32.8	27.4	59.4	2.8	V
5	3035.912868	46.0	74.0	28.0	29.5	58.8	3.0	V
6	3827.727247	42.2	74.0	31.8	30.5	58.8	3.2	V

5. BANDWIDTH TEST

5.1 LIMIT

FCC Part15.231, Subpart C			
Section	Test Item	Limit	Result
15.231(C)	20 Bandwidth	The 20dB bandwidth of the emissions shall not exceed 0.25% of the center frequency	PASS

Spectrum Parameter	Setting
Attenuation	Auto
Span Frequency	> Measurement Bandwidth
RB	10 kHz (20dB Bandwidth)
VB	30 kHz (20dB Bandwidth)
Detector	Peak
Trace	Max Hold
Sweep Time	Auto

5.2 TEST SETUP



The bandwidth of the emission shall be no wider than 0.25% of the center frequency for devices operating above 70 MHz and below 900 MHz. For devices operating above 900 MHz, the emission shall be no wider than 0.5% of the center frequency. Bandwidth is determined at the points 20 dB down from the modulated carrier.

5.3 EUT OPERATION CONDITIONS

TX mode.

5.4 TEST RESULTS

Centre Frequency	Measurement		
	20dB Bandwidth (kHz)	Limit(kHz)	Frequency Range (MHz)
433.92	69.09	1084.8	PASS



6. DUTY CYCLE

6.1 TEST PROCEDURE

The EUT was directly connected to the spectrum analyzer and antenna output port as show in the block diagram below.

The Duty Cycle Was Determined By The Following Equation: To Calculate The Actual Field Intensity,The Duty Cycle Correction Factor In Decibel Is Needed For Later Use And Can Be Obtained From Following Conversion

Duty Cycle(%)=Total On Interval In A Complete Pulse Train/ Length Of A Complete Pulse Train * %

Duty Cycle Correction Factor(Db)=20 * Log10(Duty Cycle(%))

6.2 TEST SETUP

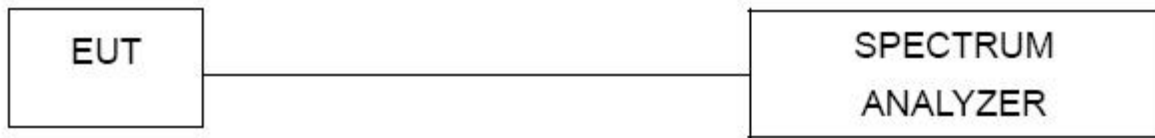

6.3 EUT OPERATION CONDITIONS

TX mode.

6.4 TEST RESULTS

FCC Part15.231(a)	
Total On interval in a complete pulse train(ms)	5.56
Length of a complete pulse train(ms)	10
Duty Cycle (%)	55.6%
Duty Cycle Correction Factor(dB)	2.55

Note:

Single off time= $3\Delta 1 - 2\Delta 1 = 0.8 - 0.43 = 0.37\text{ms}$

Total off time= $0.37 * 12 = 4.44\text{ms}$

Total on time= $10 - \text{off time} = 10 - 4.44 = 5.56\text{ms}$

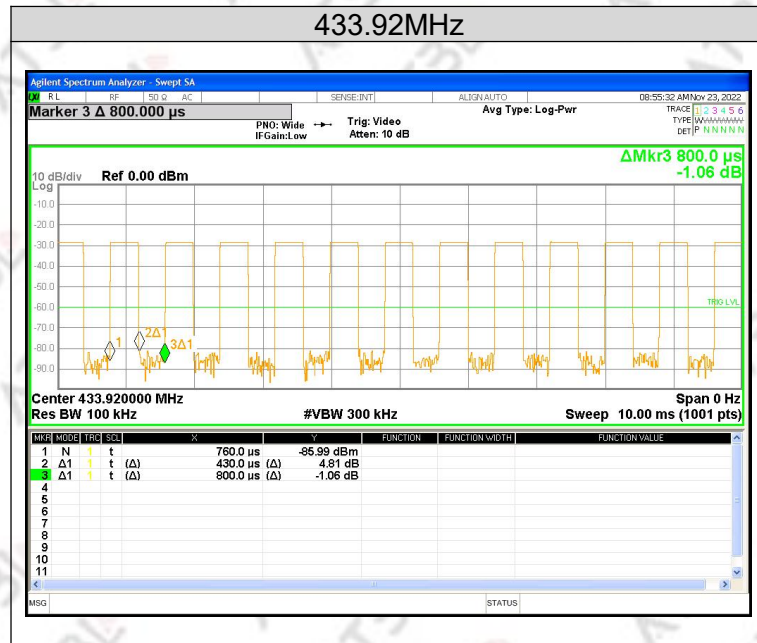

7. AUTOMATICALLY DEACTIVATE

7.1 STANDARD REQUIREMENT

A manually operated transmitter shall employ a switch that will automatically deactivate the transmitter within not more than 5 seconds of being released.

7.2 TEST PROCEDURE

The EUT was directly connected to the spectrum analyzer and antenna output port as show in the block diagram below.

Spectrum Setting: RBW= 100kHz, VBW=300kHz, Sweep time = Auto.

Note: Only press launch about 0.15 s

Note:

(1)Refer to the plot (As Below),We find a manually operated transmitter shall employ a switch that will automatically deactivate the transmitter immediately, within not more than 5 seconds of being released.

(2)The EUT is comply with FCC PART 15 clause 15.231(a)(1) manually working mode are pre-tested and only the worst result is reported.

7.3 TEST SETUP



7.4 TEST RESULTS

Activation time	Limit(Sec)	Result
0.33 s	5 s	Pass



Mark 1: Hold down the Key(Start transmitting)

Mark 2: Loose the Key

Mark 3: Stop transmitting

Activation time= Mark 3- Mark 1=3Δ1=0.33s

8. ANTENNA REQUIREMENT

8.1 STANDARD REQUIREMENT

According to the FCC Part 15 Paragraph 15.203, an intentional radiator shall be designed to ensure that no antenna other than that furnished by the responsible party shall be used with the device. The use of a permanently attached antenna to the intentional radiator shall be considered sufficient to comply with the provisions of this section.

8.2 EUT ANTENNA

The EUT antenna is PCB Antenna. It conforms to the standard requirements.

APPENDIX-PHOTOS OF TEST SETUP

Radiated Emissions for 9kHz~30MHz

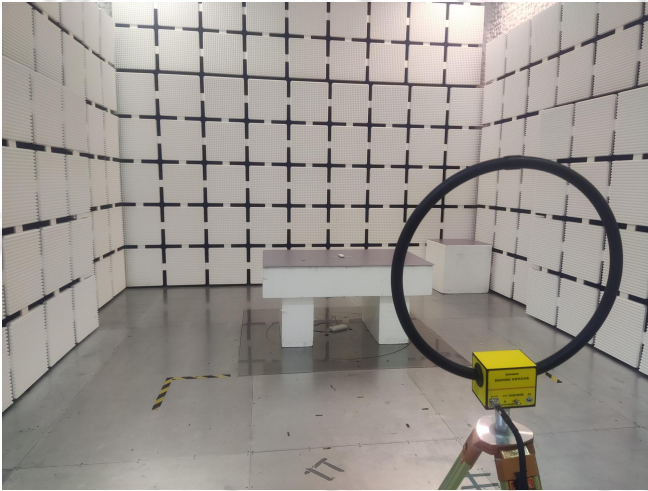

Radiated Emissions for 30MHz~1GHz



Radiated Emissions for 1GHz~5GHz



N/A

*****END OF THE REPORT*****