

RIX

FULL COLOR

NIGHTVISION SCOPE

HD SIGHT



User Manual

 (510)988-5580

 info@rix-nv.com

CONTENTS

Accessories	03	Display	14
Product Overview	03	Reticle	17
Product Features	04	PIP	21
Subassemblies and Buttons	05	Video Mode	22
Power Supply	06	WIFI	23
TF Card and Type-C Interface	07	Settings	24
Button Operation	09	Firmware Update	27
Installation	11	APP	28
Home Screen	13	APP Interface Explanation	30
Menu	14	Warnings and Precautions	31

Technical Specifications

The design and software programs may be continuously updated in order to refine the features of the product.

* The technical parameters of the products are subject to change without notice.

Model		T20
Detector Specifications	Sensor Resolution, pixels	1920 × 1080
	Pixel Size, μm	2.9
Optical Specifications	Objective Lens, mm	50mm F1.4
	Field of View, °	4.8 x 3.6
	Linear Field of View(HxV),m@100m	8.4x 6.3
	Optical Magnification, ×	3.5 ~ 14.0
	Digital Zoom, ×	1~4
	Eye Relief, mm	50
	Diopter Adjustment, D	-5~+5
Display Specifications	Detection Range, m	300
	Type	OLED
Battery Power Supply	Resolution, pixels	1024x 768
	Battery Type	Built-in battery pack
	Max. Operating Time(t=22°C)*, h	14
	External Power Supply	5V(Type C)

	Model	T20
Physical Specifications	Wi-Fi / APP	Support (RIX+)
	Video Recorder	Support
	Memory Capacity, GB	4 to 256GB
	IP Rating	IP68
	Operating Temperature	-20°C~ +50°C / -4 F~122 F
	Weight	1030g / 2 lbs
	Dimension	388X82X71mm/15.2x3.2x2.8 in
	Body Material	Aluminum
Connections and Compatibilities	Max. Recoil Power on Rifled Weapon (Eo), g	1500
	Aim Point, MOA/CLICK	0.28 (8.2mm@100m)
	Mount	Standard 30mm rings
Function	IR Illuminator, nm	850 / 940 (Optional)
	IR Power, w	5

01 Accessories













- Night vision scope
- Rubber eyecup
- Mount×4
- IR Illuminator
- Battery charger
- Clean cloth
- USB cable
- User manual

02 Product Overview

A modern digital optics product that offers a wide range of functions that simplify and enhance the hunting experience for enthusiasts of all skill levels. Advanced optical technology that features a night vision mode with a crystal-clear resolution of 1080P on a high-definition screen for precise image observation.

Utilizing the CMOS sensor and a single core A9 processor you can easily record and preview videos simultaneously on your smartphone. Experience a much longer lasting battery life with a built-in lithium-ion battery that provides up to 14 hours of continuous power. The upgraded “one-shot zero” system minimizes the time and effort required to zero the scope for optimal accuracy.

03 Product Features

 VIVID IMAGING	 FULL COLOR NIGHT VISION
 RECORD HD VIDEO	 RECOIL ACTIVATED VIDEO
 PIP	 FOCUS CROSS PATTERN
 WIFI	 E-COMPASS
 ULTRA LOW POWER CONSUMPTION	 ONE SHOT ZERO
 SINGLE CORE A9	 SHARE ON SOCIAL MEDIA

04 Subassemblies and Buttons

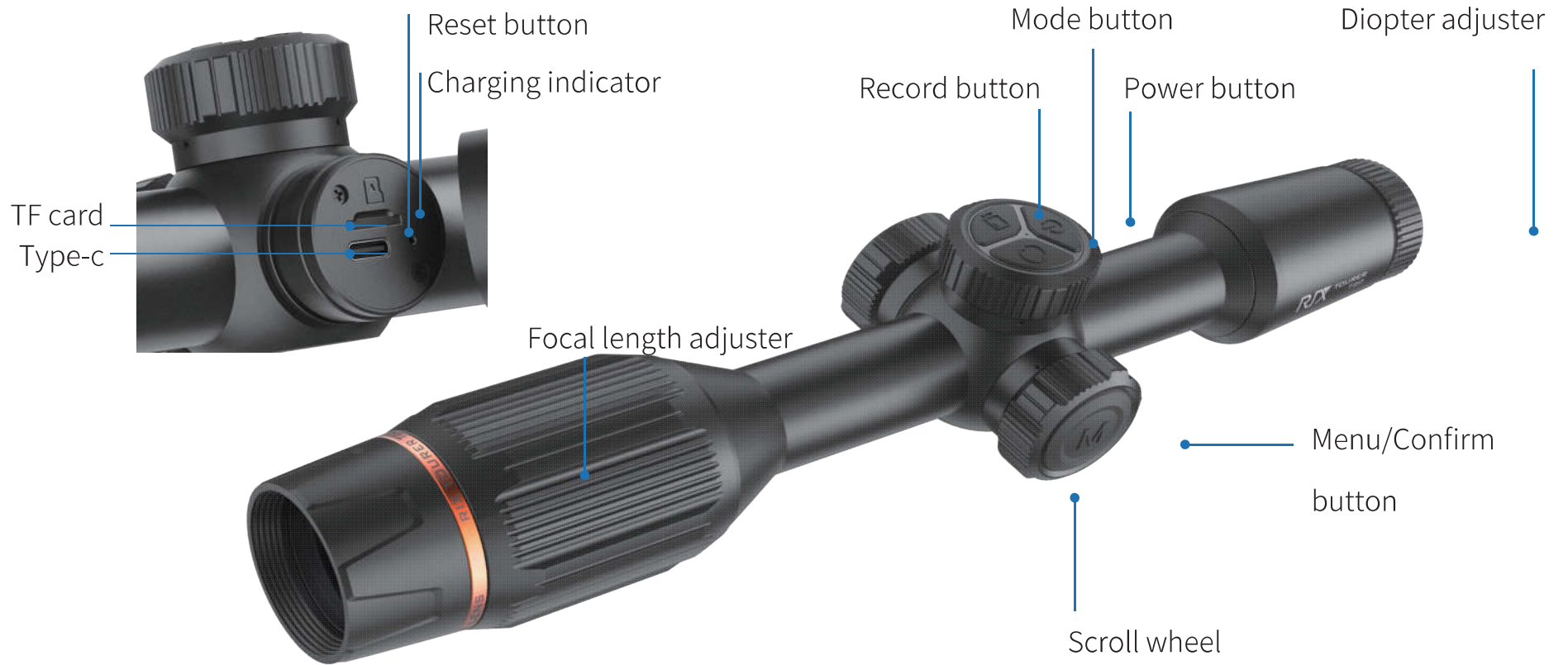

05 Power Supply

Open the Type-C cover of the device and connect the Type-C charging cable from the power adapter to the device port. Charging with a low-current charger will take a longer time. Using a 9V/2A USB charger only takes 3.5 hours to charge the scope.

1. It is recommended to use a 2A USB charger.
2. A fully charged battery can operate for 14 hours.

06 TF Card and Type-C Interface

TF Card

To access the interface, rotate and remove the cover on the right side of the device, as illustrated in the right .

Note:

1. Do not insert the TF card in reverse, as it may damage the device and the memory card.
2. Format the TF card on the device before using it for the first time.
3. Always power off the device before inserting the memory card.
4. The charging indicator will flash during charging and remain solid when fully charged.



Type-C Interface

Connect the device to your PC or Laptop using the provided data cable. Once the device is powered on you should see the screen on the right.



TF card file preview: Select Mass Storage on the device, and it will enter USB mode. You can view and play files from the TF card on the computer.

Real-time image: Select PC Camera mode, and open the dedicated player "  AMCap" on the computer.

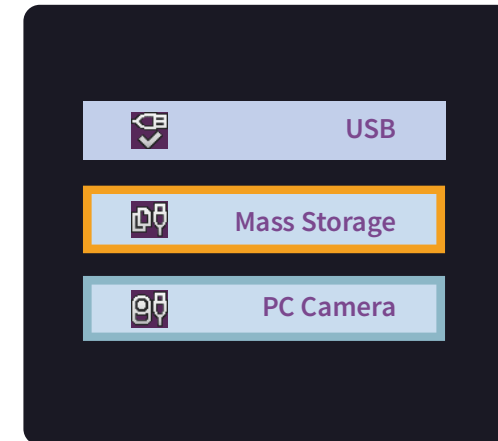
The device acts as a camera for the computer, and the device's image is displayed synchronously on the computer monitor.



07 Button Operation

Button	Current Status	Short Press	Long Press	Rotate
Power button 	Powered off	/	Power on the device	/
	Home screen	Standby the device	Shut down the device	/
	Standby	Wake up the device		/
	Main menu screen	Return to the upper menu with saving changes	/	/
Video button 	Home screen	Start / Stop video recording	Take a photo	/
Image Mode button 	Home screen	Switch Image Mode	Turn on/off the PIP function	/

Button	Current Status	Short Press	Long Press	Rotate
Controller 	Home screen	Open the main menu function	/	Adjust the magnification
	Main menu interface	Switch on or off / Confirm selection / Enter the submenu	Save and back to the main menu interface	Switch menu options
	Zeroing interface	Confirm or cancel selection / freeze or resume image		Switch movement direction between X axis and Y axis / Move reticle position: Clockwise: move to the left / down

Diopter adjuster:

To achieve optimal visual clarity, simply rotate the diopter adjustment ring. Through the eyepiece, carefully observe the reticle and widgets on the focusing screen while making the necessary adjustments.

Distance focal length adjustment:

Rotate the adjustment ring accordingly to attain precise focus at varying distances.



Diopter adjuster



Focal length adjuster

08 Installation

The package includes two picatinny rail mounts and two flashlight-type mounts. Install them using the standard procedure typically employed for mounting a regular scope.

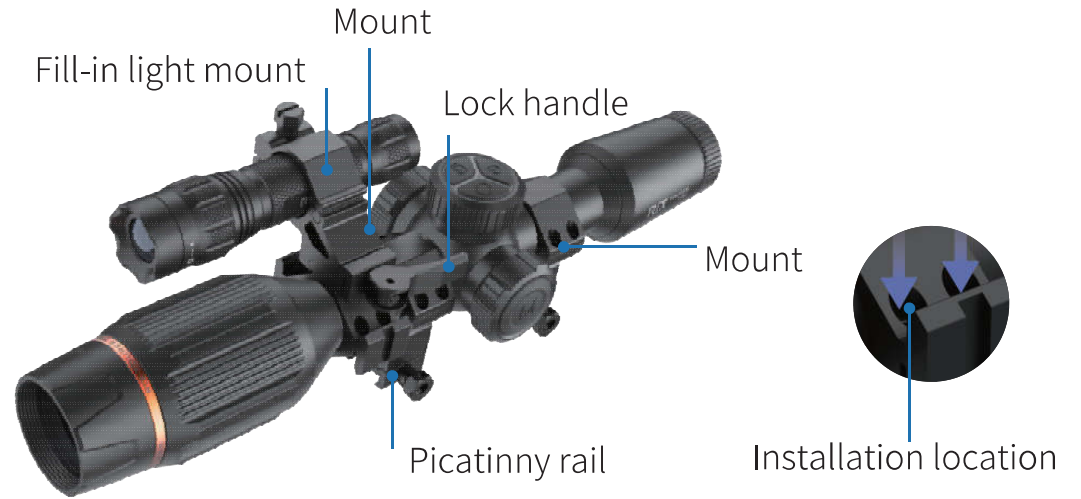

Thermal Fill-In Light Instructions:



Exploded diagram

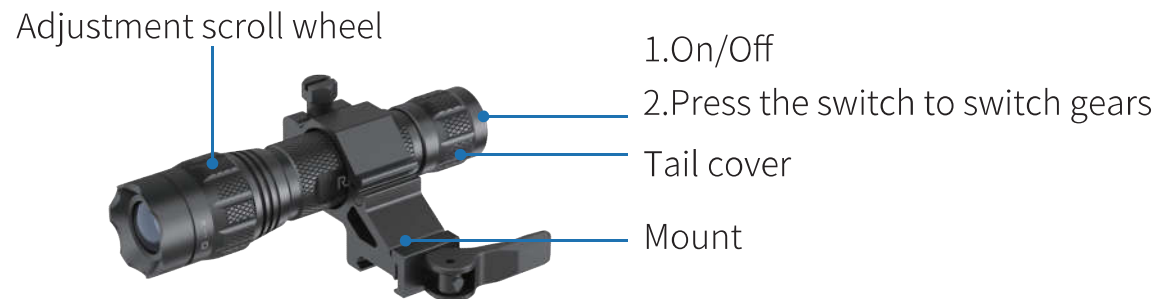



Prior to installation, avoid directing the device towards your eyes, as the emitted IR Illuminator can potentially harm them. Please note that RIX Optics holds no liability for any injuries resulting from improper operation.

Rotate the scroll wheel located on the head of the device to adjust and focus the light beam, allowing for an extended distance of illumination.

Tail power switch:

Once the thermal IR Illuminator is activated, simply press the Switch button to cycle through the high, medium, and low modes. Adjust the mode based on your specific needs and preferences. Switch the mode according to your actual needs.





1. When tightening/loosening the tail cap, hold the battery and flashlight tube firmly.
2. Install the battery into the device, paying attention to the correct polarity.
3. Re-attach the tail cap to the main body.



09 Home Screen

Once the device is turned on, the screen will show the layout depicted in the picture on the right. To view additional information like the compass, horizontal angle, and X/Y axis coordinates, simply select the corresponding settings in the menu.

Status bar

-  Indicates the battery level.
-  Displays whether the memory card is installed.
-  Appears only when the feature is activated.
-  22.09.38 Shows the current available recording time on the TF card.

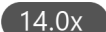
 14.0x Rotate the scroll wheel in the preview interface to display the current zoom step.

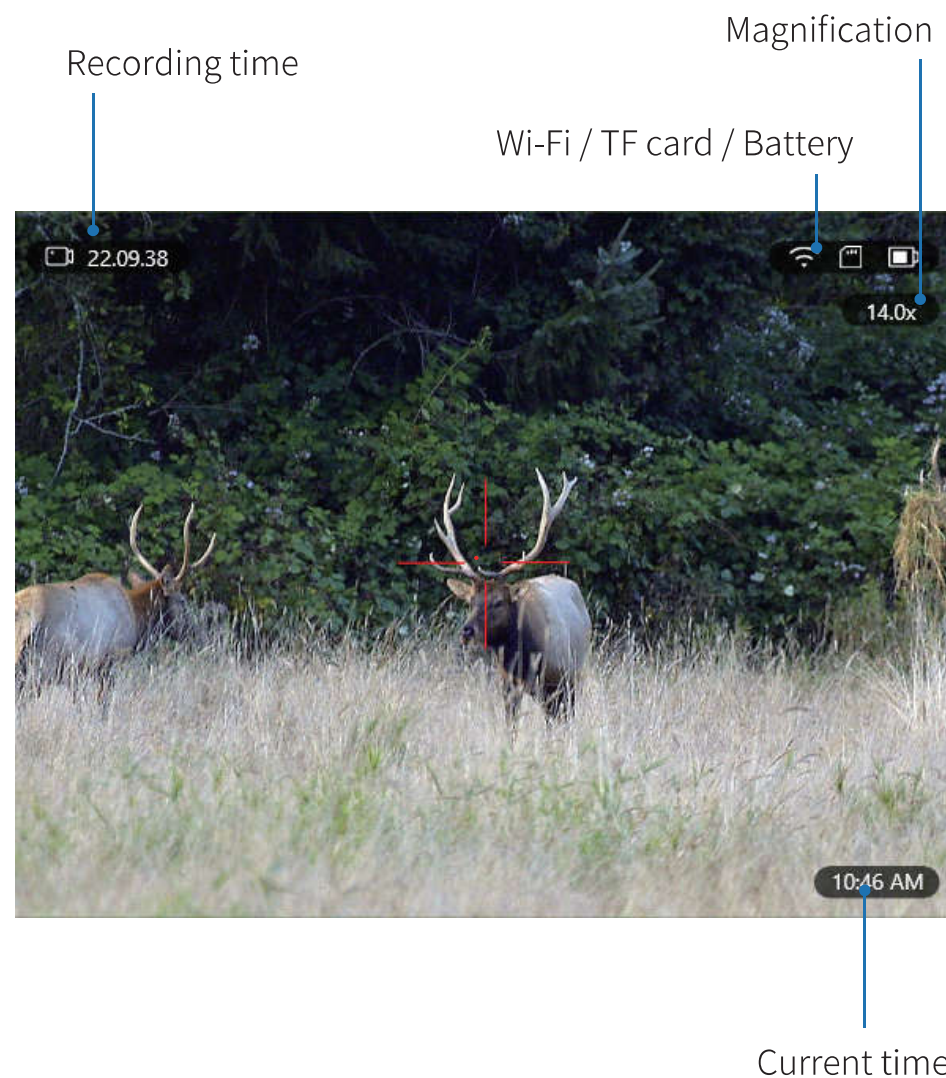

10 Menu

While in the preview interface, press the Menu button to access the main menu interface (as displayed in the picture below). Utilize the scroll wheel to navigate through the settings by rotating it up or down, and press the Menu button to enter the next-level menu.

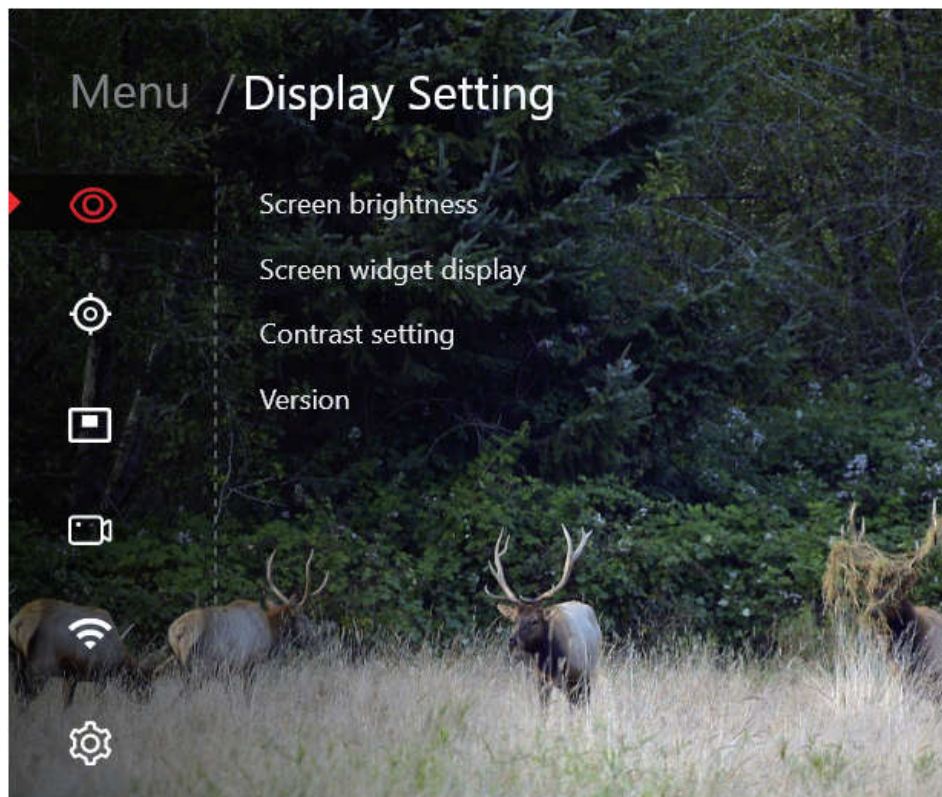

11 Display

Upon entering this menu, you can choose from the following submenus.

- Screen brightness
- Screen widget display
- Contrast setting
- Version

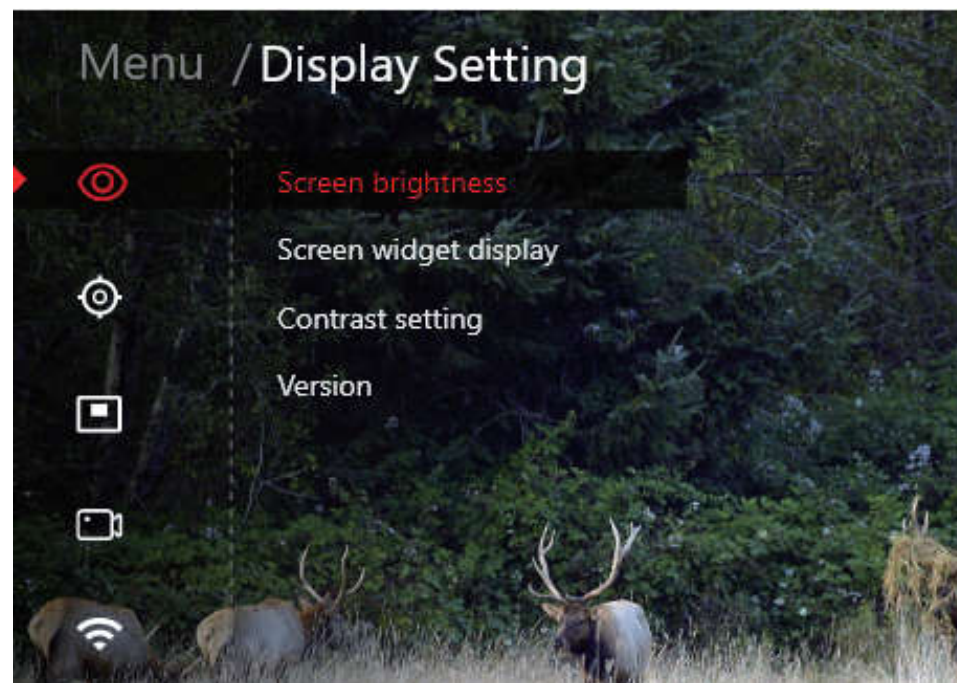

1. Screen Brightness

You can adjust the screen brightness with AUTO 1–5 options, ranging from dimmest (1) to brightest (5). The AUTO mode automatically adapts the screen brightness based on environmental changes. Users have the flexibility to customize the brightness according to their preferences.

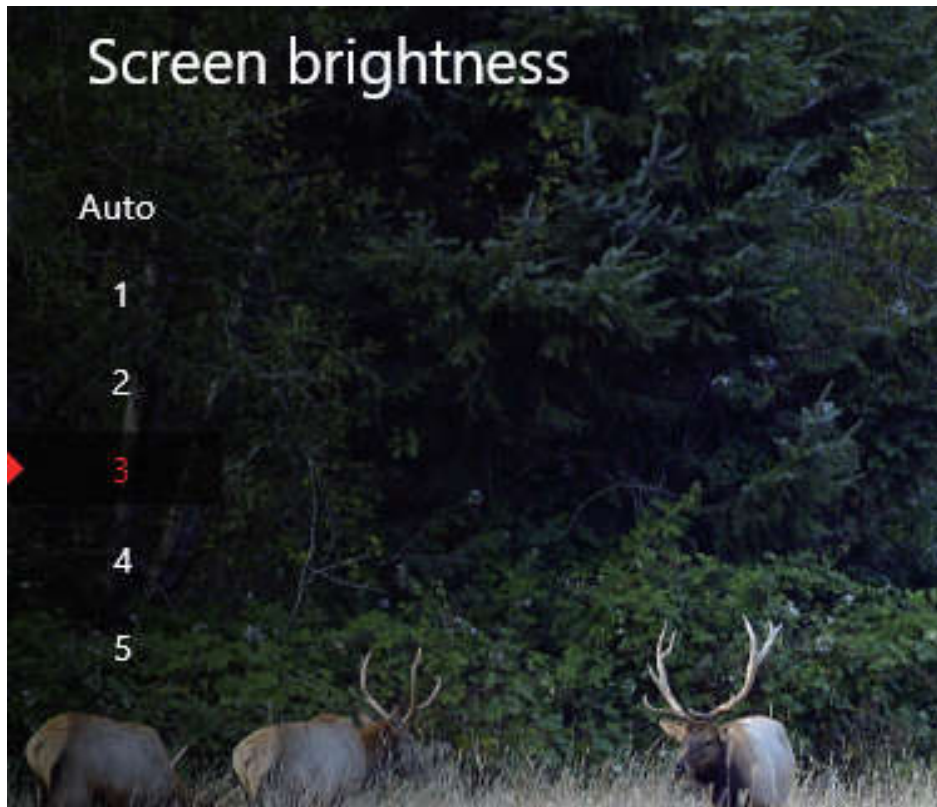

2. Screen Widget Display

You can choose which functions to display on the preview interface, such as the compass and angle of pitch. Refer to the picture below for more information. Simply toggle this option ON or OFF according to your preference.

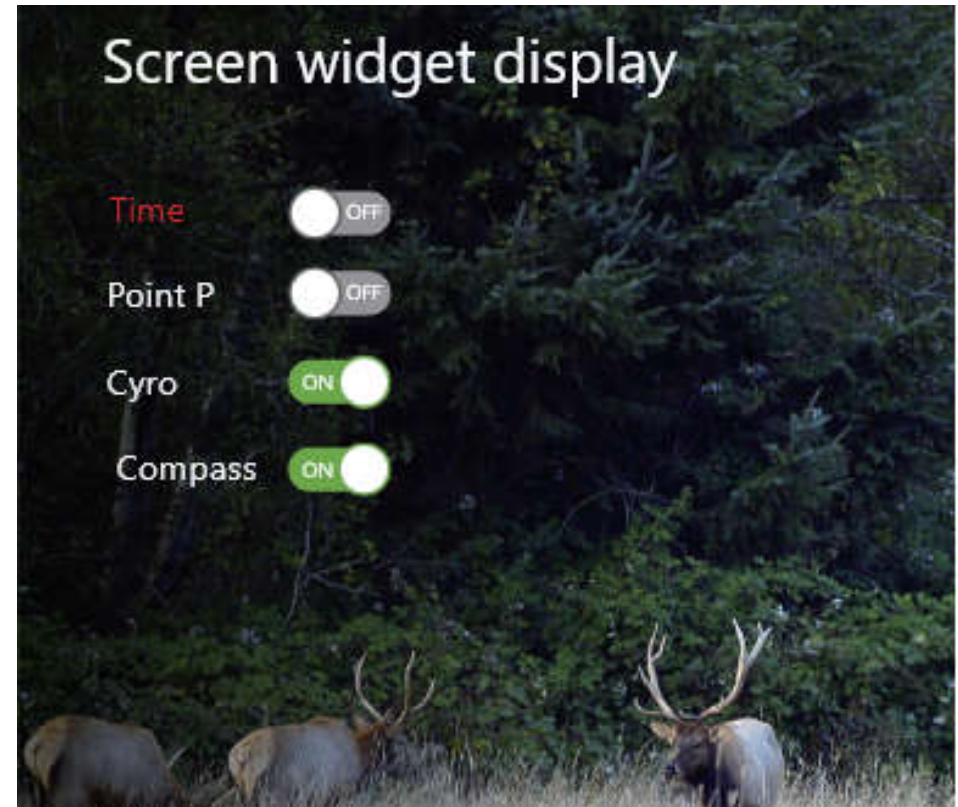

3. Contrast Setting

Customize the contrast value to suit the specific needs of the onsite environment. There are five contrast levels available: 1, 2, 3, 4, and 5.



4. Version

Displays the current firmware version of the device, e.g.,
Version: XX.xx

12 Reticle

Rotate the scroll wheel to access the reticle menu and press the Confirm button to enter the reticle calibration settings menu (as shown in the picture below).

Upon entering this menu, you can choose from the following submenus.

- Reticle color
- Reticle shape
- Reticle calibration
- Reticle position

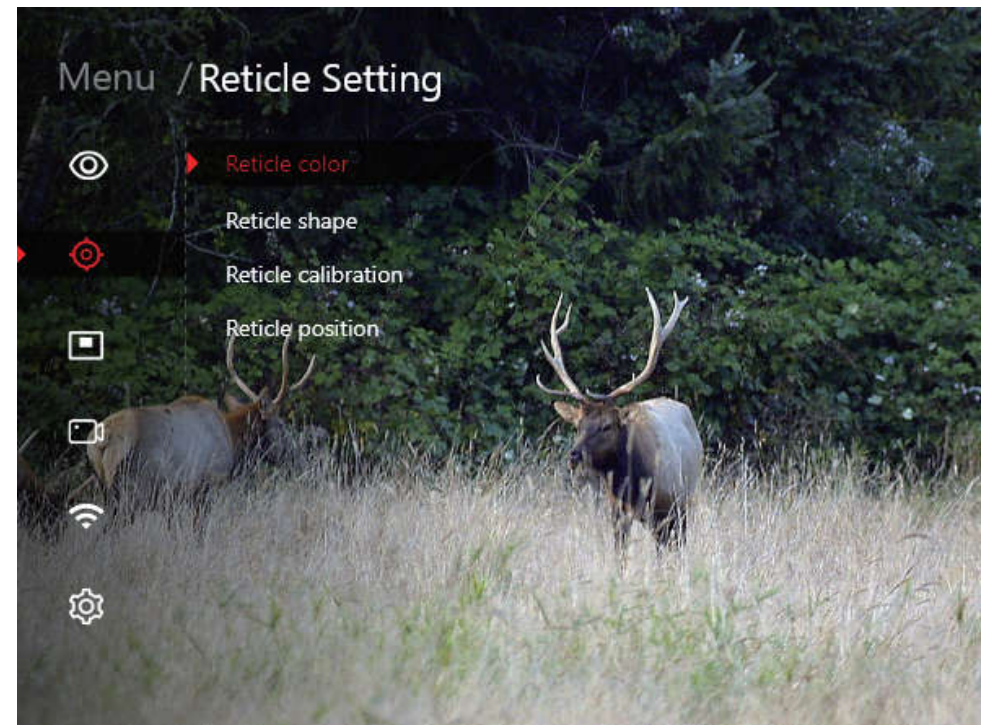

1. Reticle Color

Choose from five different colors for the reticle. Rotate the scroll wheel to switch colors and press the Menu button to save.

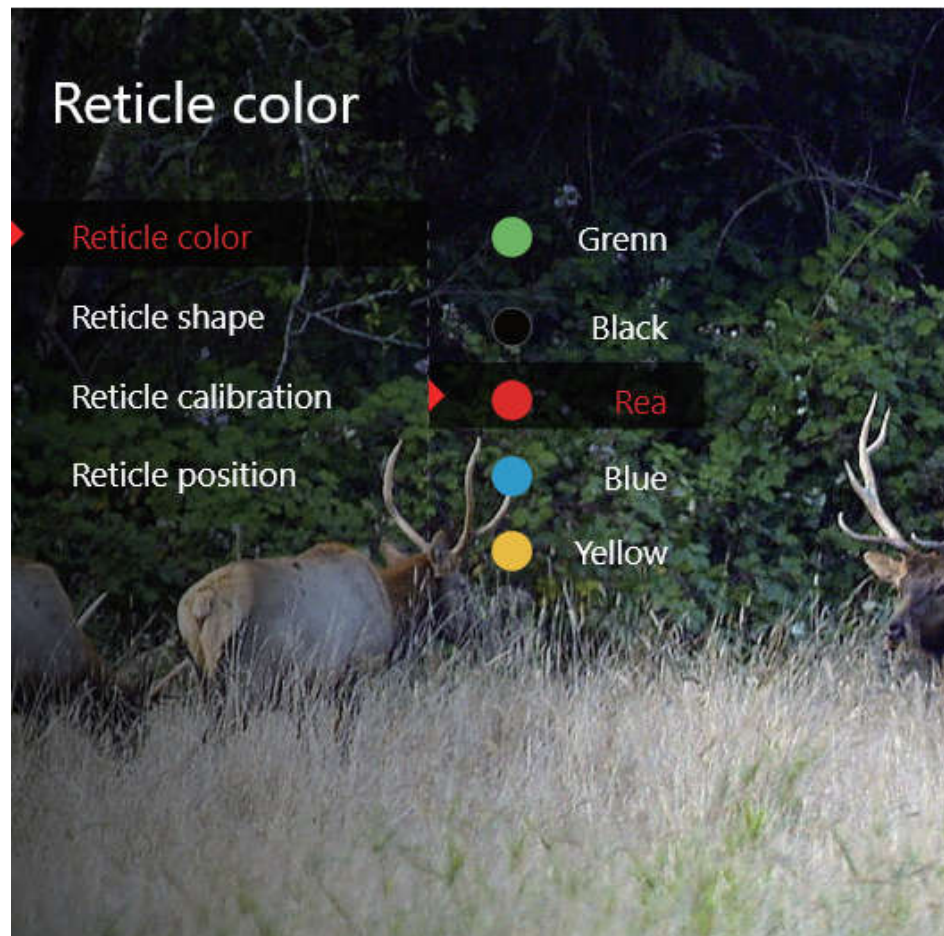

2. Reticle Shape

Select from eight different styles of reticle. Rotate the scroll wheel to switch shapes and press the Menu button to save.

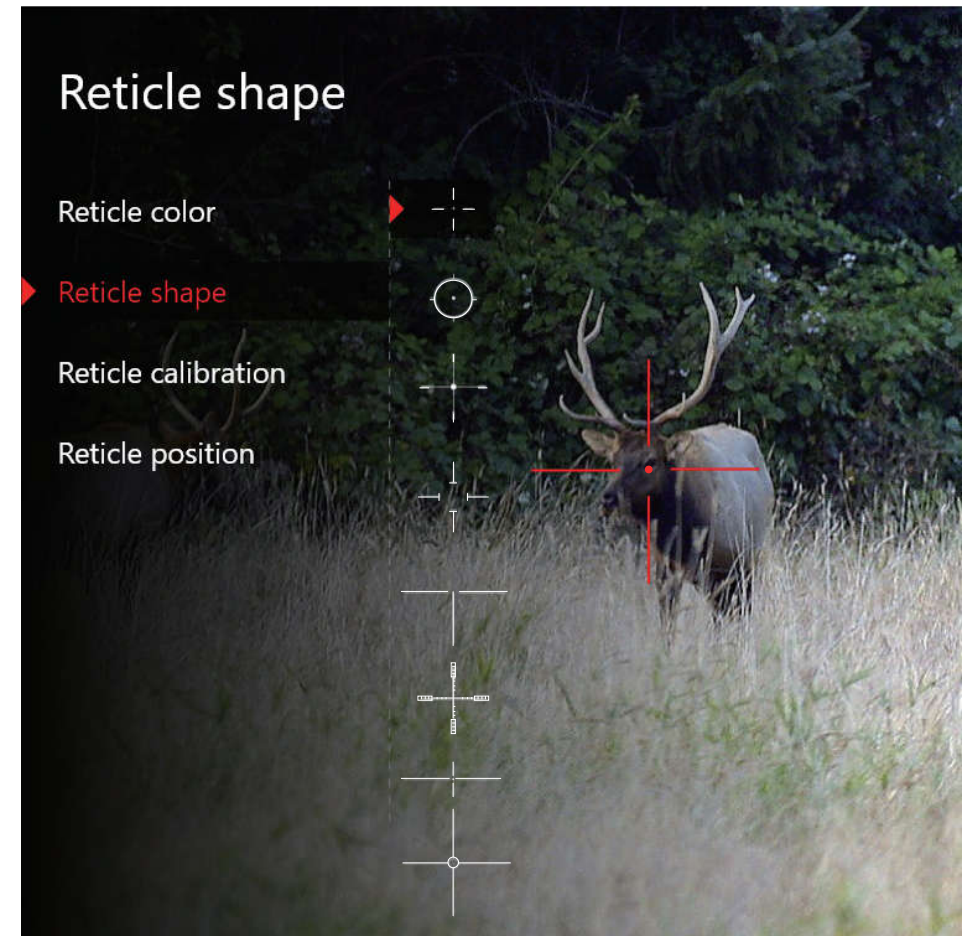

3. Reticle Calibration

1. Enter the reticle setting menu and select Reticle calibration.
(As shown in the picture below).

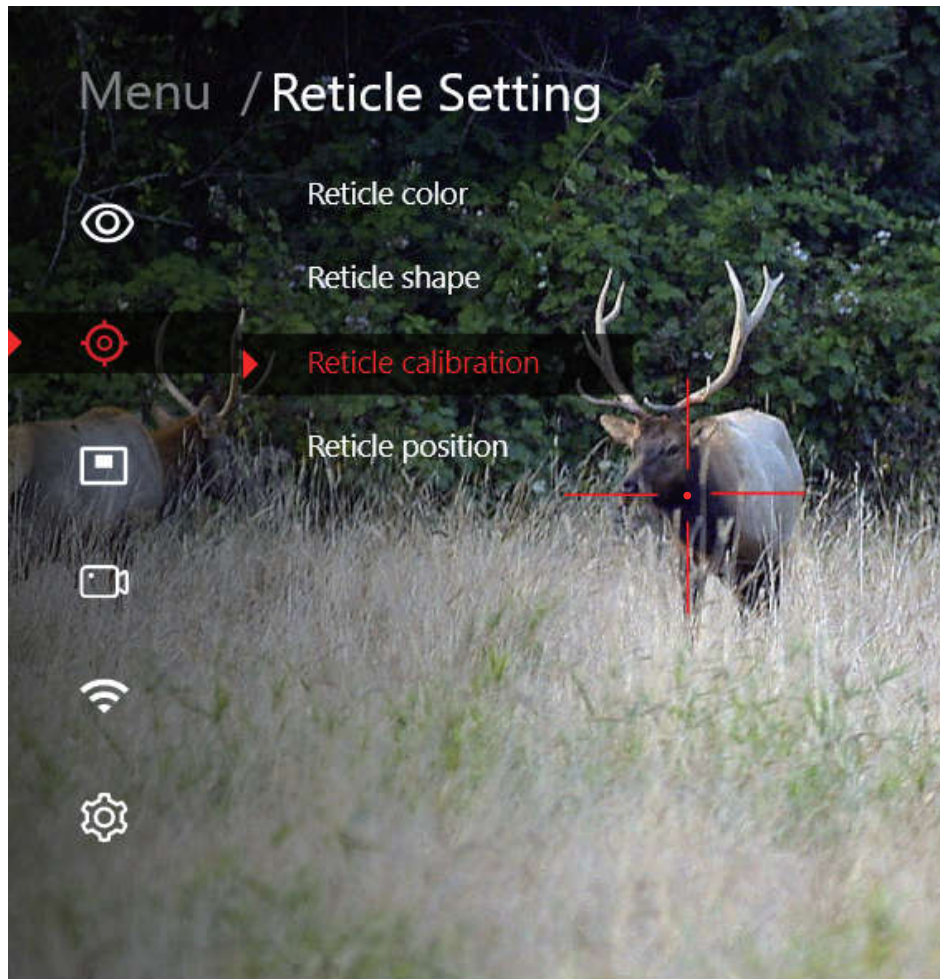

2. The red reticle remains fixed at the center of the screen. The white reticle represents the currently adjusted reticle. When entering this option for the first time, the white and red reticles coincide ($X=0, Y=0$), indicating the current coordinate values of the reticle. "100M" represents the adjustable distance of the point of impact.

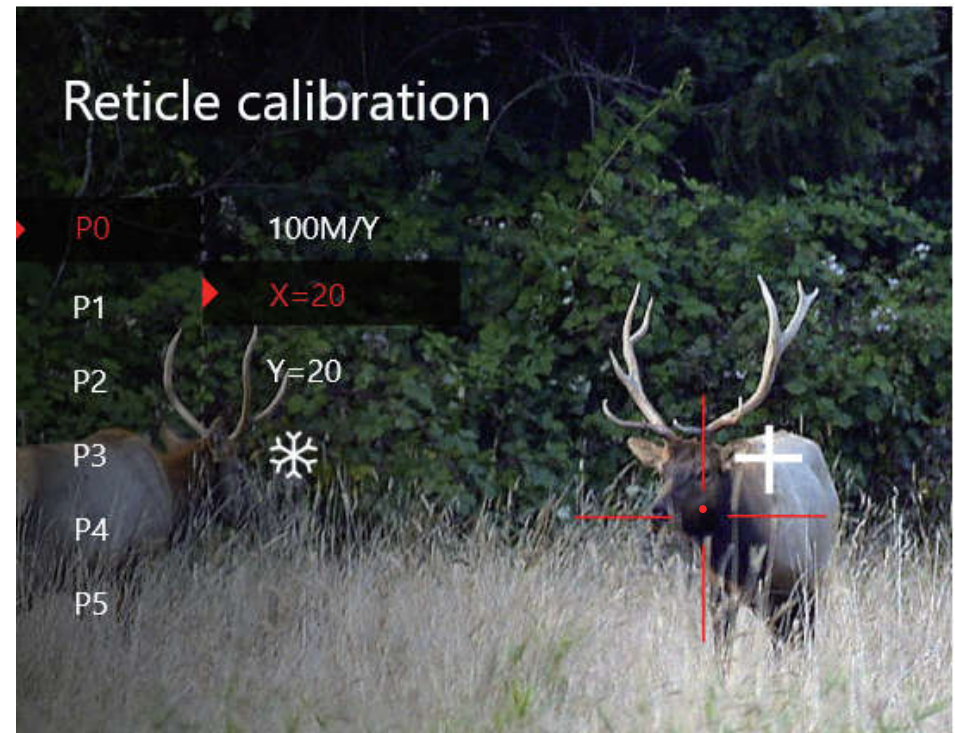

3. Adjust the X-axis and Y-axis using the scroll wheel to align with the point of impact.

4. "Snowflake icon ❄️" function: (For more precise adjustment of bullet impact and target deviation).

Operating procedures

1. After shooting the target three times consecutively, confirm the position of the impact point.
2. Click the "Snowflake icon ❄️" to freeze the screen. The screen will be locked.
3. Align the reticle (X/Y axis) to the new impact point by considering the offset distance value. Press the Confirm button to save the adjusted settings. If there is still any deviation, continue with the adjustment process until the target is accurately hit.

4. Reticle Position

Users have the ability to save various reticle calibration positions corresponding to different usage environments (with X/Y=0 as the factory default setting). The device has a capacity to store up to five positions, allowing you to conveniently recall and utilize the one that best matches the current usage environment.

Refer to the picture below to access the reticle coordinate recall option. Utilize the scroll wheel to choose the desired coordinate, and press the Confirm button to successfully recall the coordinates and return to the upper menu.

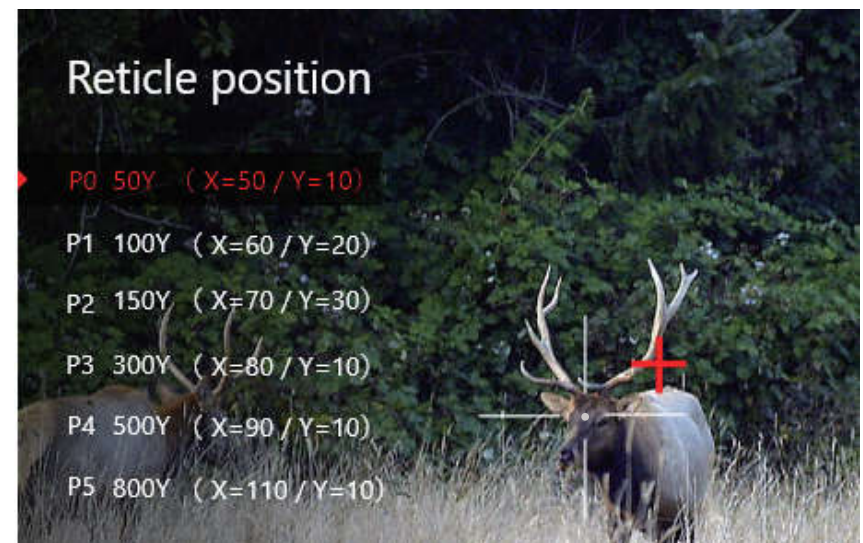
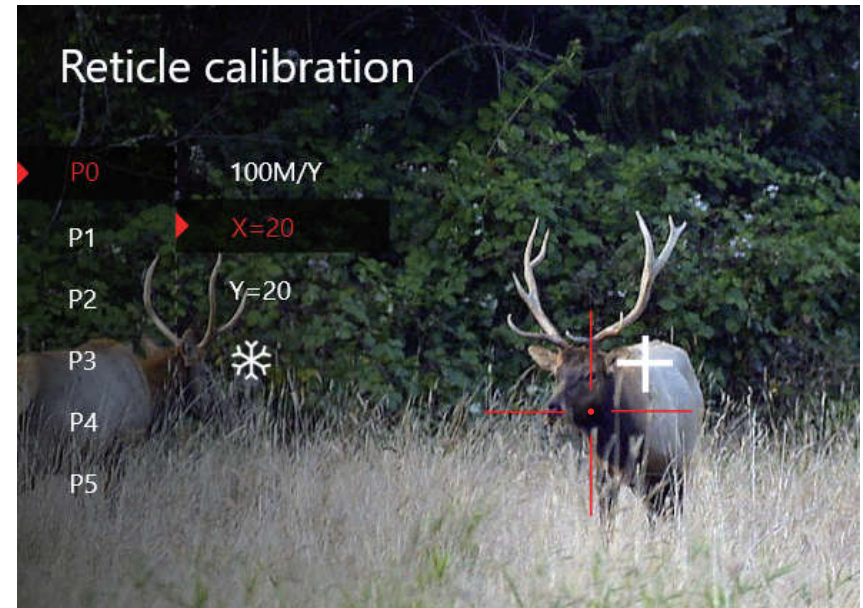

13 PIP

Once you select this function (or utilize the shortcut key), the target located at the center of the reticle will be magnified and displayed at the top of the screen, enhancing visibility. To return to the preview interface, simply press the Power button.

- . PIP window
- . Freely change the window magnification.
- . Shortcut key: Press and hold the Mode button to toggle PIP on/off.



14 Video Mode

1. Resolution settings

Enter the menu interface and use the scroll wheel to select video mode, where you can adjust the recording resolution return to the preview interface.

2. Recoil activated video

Activate the recoil-activated video function, which automatically initiates recording when a recoil is detected. The recording duration is set at 30 seconds, with 8 seconds captured prior to the recoil and 22 seconds recorded after the recoil.

The recorded video files are saved in DCIM\Pre_Video

The file name is 20230408153256_0000002.

Note:

The recoil activated video folder is separate from the regular video folder.

The recording icon  changes to the recoil activated video icon  when activated.

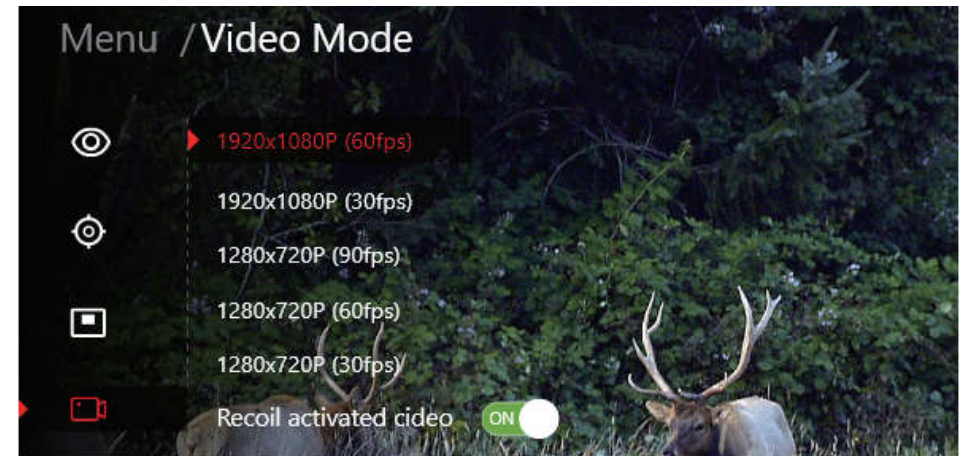

15 WIFI

Enter the menu to view the Wi-Fi name and password.

SSID: RIX_T20_XXXXXX

PW: 12345678

After activating the Wi-Fi function on the device, you can establish a connection with the app and operate the device directly from the app.

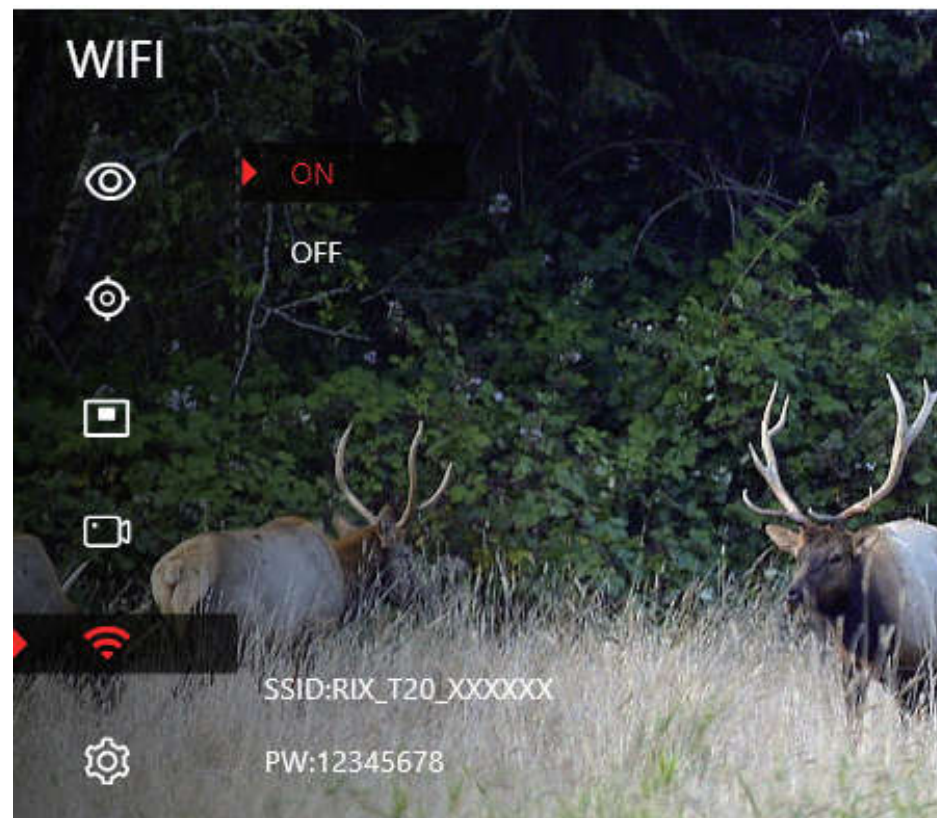

16 Settings

To access the main menu interface from the preview screen, simply press the Menu button (as illustrated in the picture right). Use the scroll wheel to navigate up and down and select desired settings, then press the Menu button again to enter the next-level menu.

You can set the following parameters in this menu.

- Language
- Date/time
- Gyro calibration
- Compass correction
- Auto power off
- Distance unit
- Format
- Default setting

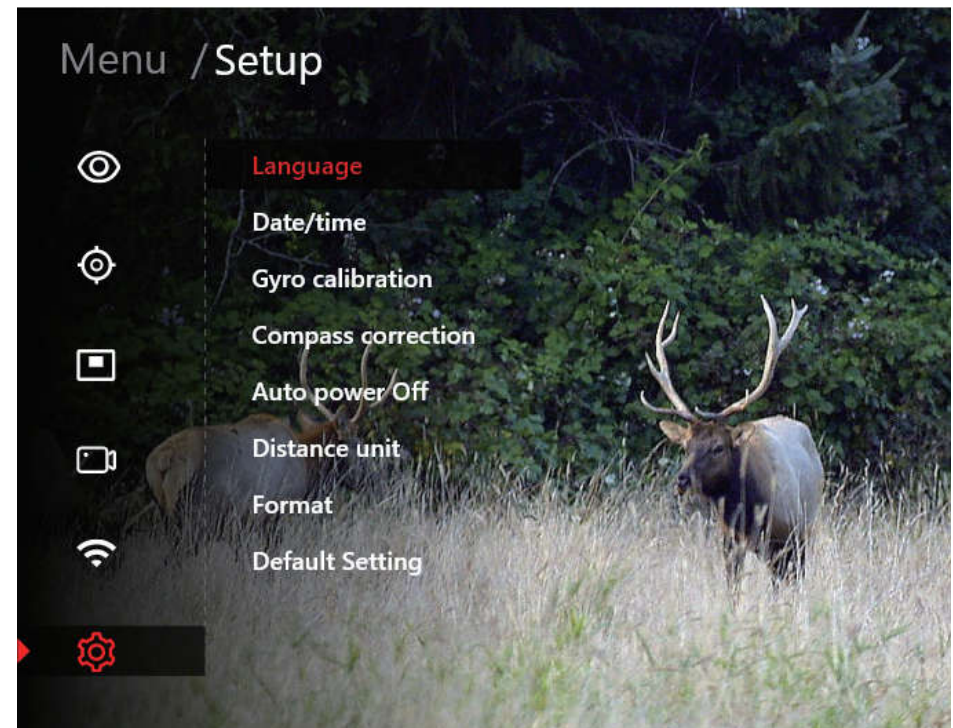

1. Language

Multiple language options available (as shown in the picture below).



2. Date/time

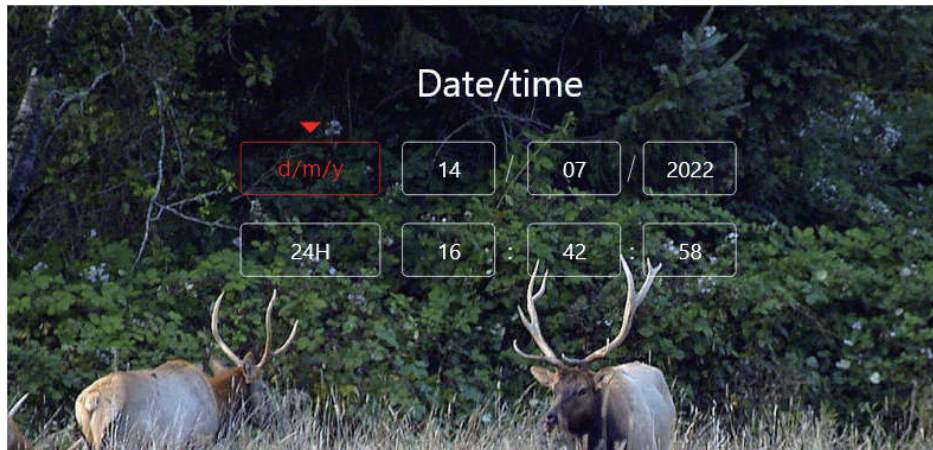

3. Gyro calibration

Enter the settings menu, place the device horizontally, press on Gyro calibration, and follow the on-screen prompts for operation.

Note: When calibrating the device, keep it parallel to the ground for optimal compass performance.

4. Compass correction

Enter the settings menu, press on Compass correction, and follow the on-screen prompts for operation, as shown in the picture.

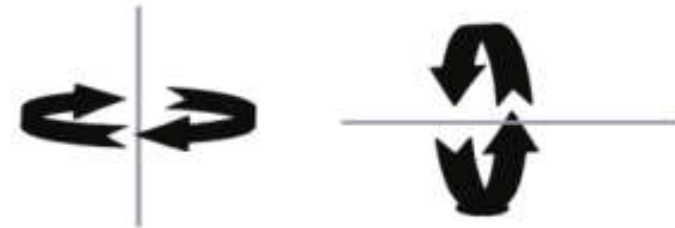

5. Auto power off

Customize the auto power off time according to your preference within the range of 1 to 59 minutes. The default setting is 3 minutes. Utilize the up and down knobs to adjust the time to your desired duration.

Auto power off takes effect only when the device is manually put into standby mode; it does not apply to other states.

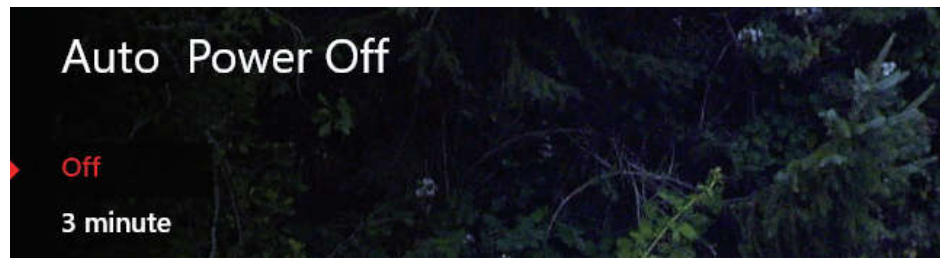

6. Distance unit

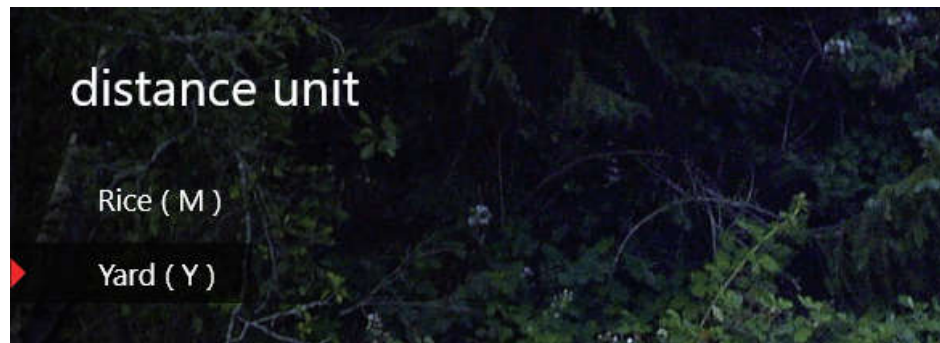

7. Format

Formatting will erase all files on the TF card. Please proceed with caution.



8. Default setting

Note: Restoring to default settings will reset all saved parameters to factory settings. Please proceed with caution.

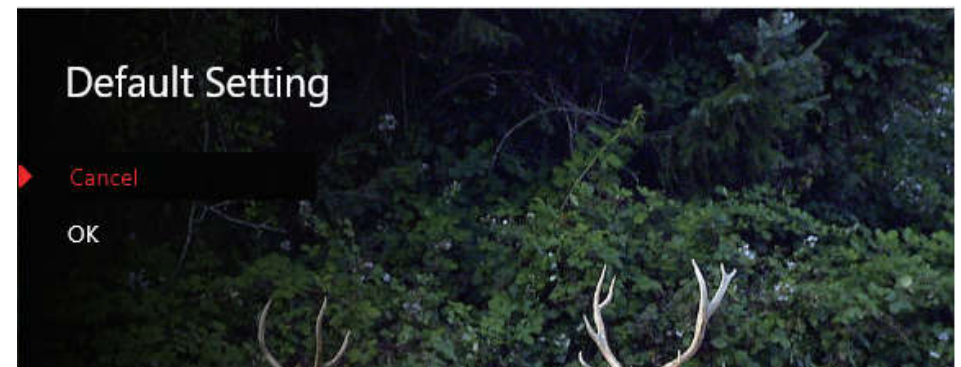

17 Firmware Update

📄 RIX20Firmware_xxxxxxx.bin

Download file package to TF card

TF Card Upgrade Steps

1. Copy the file for update "RIX20Firmware_xxxxxxx.bin" to the TF card.
2. With the device powered off, insert the TF card with the copied program into the device.
3. Upon pressing the Power button, a prompt will appear on the screen asking if you wish to proceed with the upgrade. Choose "ok" to initiate the automatic upgrade process. The screen will then display an upgrade progress bar (as depicted in the picture on the right).
4. Once the upgrade is complete, the device will automatically power on.
5. Remove the TF card and delete the upgrade file or format the entire card using the device's formatting function.

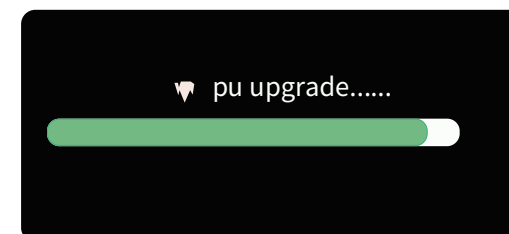
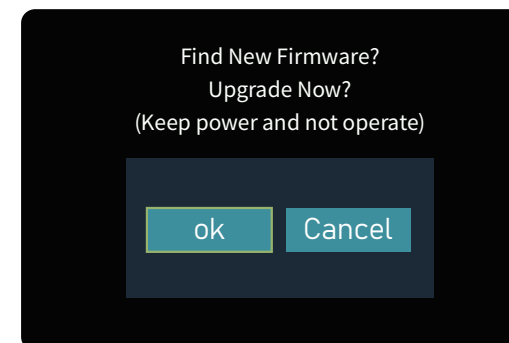

Formatting will erase any existing recorded videos or images on the device.

18 APP



Establish a Wi-Fi connection between the device and your mobile phone or tablet and enjoy seamless video streaming through the app. To access the latest version of the application, visit the Apple App Store or Google Play Store for download.



1. Search for "RiX+" and download/install the application.



2. Ensure that the Wi-Fi is enabled on your mobile device.

3. In the Wi-Fi settings of your phone, find the corresponding Wi-Fi network with the name: **SSID: RiX_T20_XXXXXX**. Enter the password "12345678" and tap Done. The Wi-Fi name should show a checkmark (✓) indicating a successful connection .

4. Open the app, select the corresponding device model, tap Connect, and you will see a real-time video feed on your mobile device, confirming the successful connection. You can now control your device through the app.

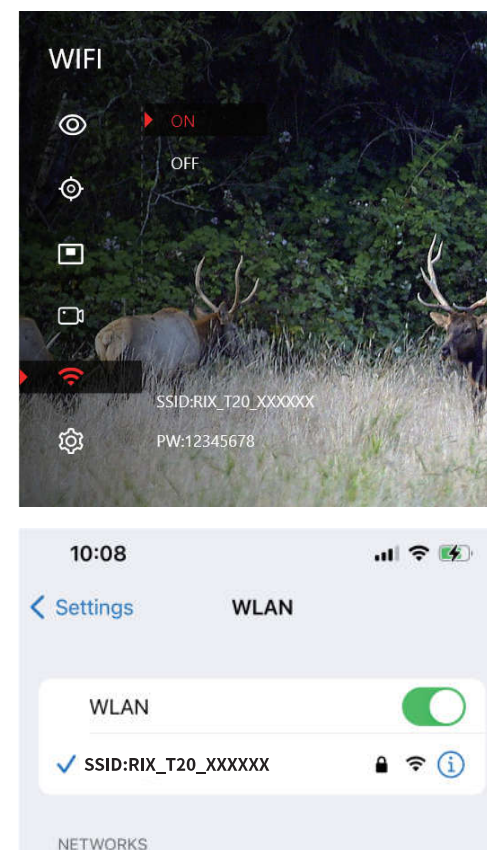

19 APP Interface Explanation

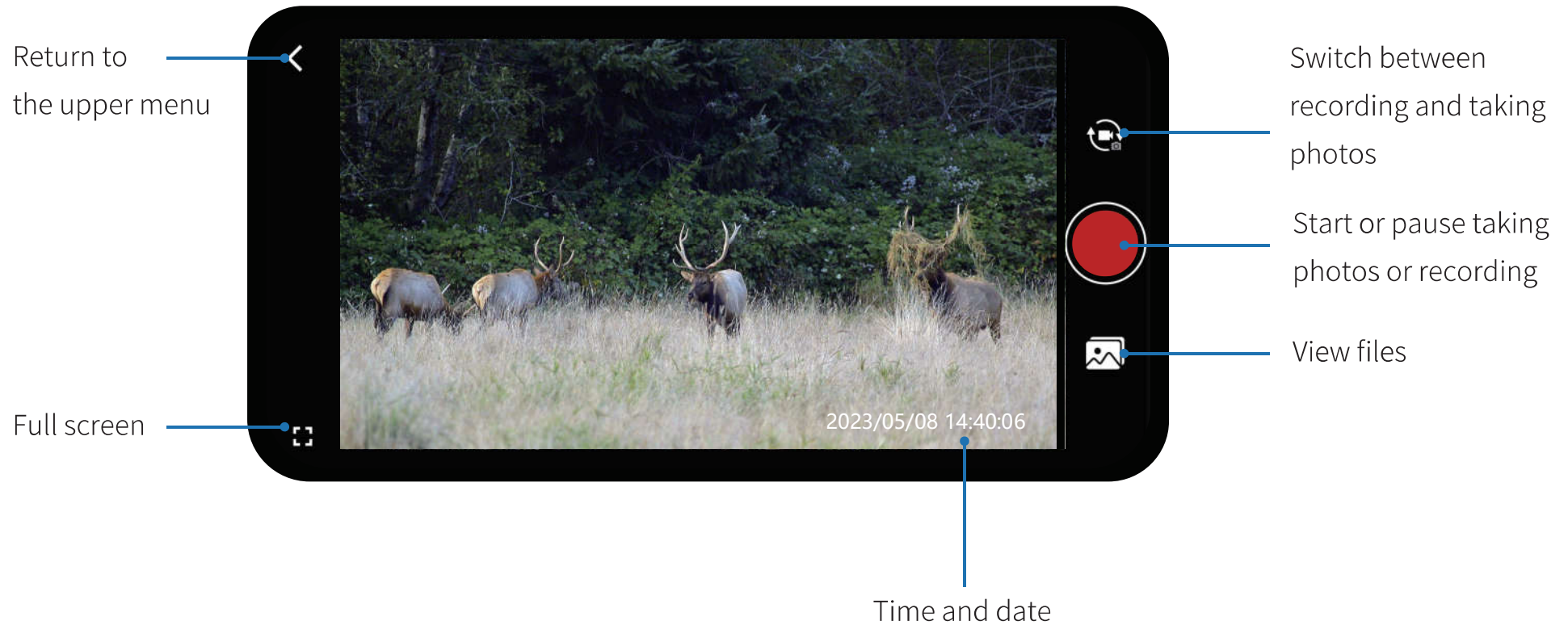

20 Warnings and Precautions

Please ensure to power off the device when it is not in use.

Avoid dismantling, dropping, opening, crushing, bending, deforming, piercing, cutting, microwaving, incinerating, painting, or inserting foreign objects into the device, as these actions will void the warranty.

Keep it away from dust, steam, and gases.

It's important to note that this product contains natural latex, which may cause allergic reactions.

Handle the device with care, as it is a delicate precision optical-electronic instrument.

Refrain from scratching the external lens surfaces and avoid touching them with your fingers.

! Failure to comply with these safety instructions may result in damage to the device!



FCC ID:2A7ZZ-4F-00

FCC Caution

FCC ID:2A7ZZ-4F-00

§ 15.19 Labeling requirements.

This device complies with part 15 of the FCC Rules. Operation is subject to the following two conditions: (1) This device may not cause harmful interference, and (2) this device must accept any interference received, including interference that may cause undesired operation.

§ 15.21 Information to user.

Any Changes or modifications not expressly approved by the party responsible for compliance could void the user's authority to operate the equipment.

§ 15.105 Information to the user.

Note: This equipment has been tested and found to comply with the limits for a Class B digital device, pursuant to part 15 of the FCC Rules. These limits are designed to provide reasonable protection against harmful interference in a residential installation. This equipment generates uses and can radiate radio frequency energy and, if not installed and used in accordance with the instructions, may cause harmful interference to radio or television communications. However, there is no guarantee that interference will not occur in a particular installation. If this equipment does cause harmful interference to radio or television reception, which can be determined by turning the equipment off and on, the user is encouraged to try to correct the interference by one or more of the following measures:

- Reorient or relocate the receiving antenna.
- Increase the separation between the equipment and receiver.
- Connect the equipment into an outlet on a circuit different from that to which the receiver is connected.
- Consult the dealer or an experienced radio/TV technician for help.

Body-worn Operation

This device was tested for typical body-worn operations. To comply with RF exposure requirements, a minimum separation distance of 0mm must be maintained between the user's body, including the antenna. Third-party belt-clips, holsters, and similar accessories used by this device should not contain any metallic components. Body-worn accessories that do not meet these requirements may not comply with RF exposure requirements and should be avoided. Use only the supplied or an approved antenna.

RUX