

Features

- 1.Surface Mounted Devices with a small dimension of 1.6 x 0.8 x 0.8 mm meet futureminiaturization trend.
- 2,Embedded and LTCC(low temperature co-fired ceramic) technology is able to integrate with system design as well as beautifying the housing of final product.
- 3.High stability and low tolerance.

Applications

1. Bluetooth
2. Wireless LAN
3. ISM band 2.4GHz wireless applications

Dimensions (Unit: mm)

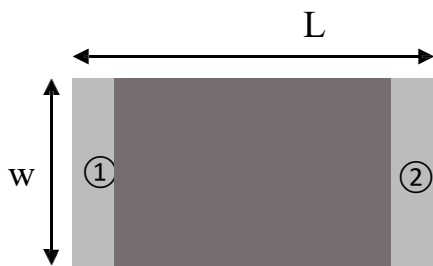

(Top View)

Number	Terminal Name
①	INPUT
②	NC

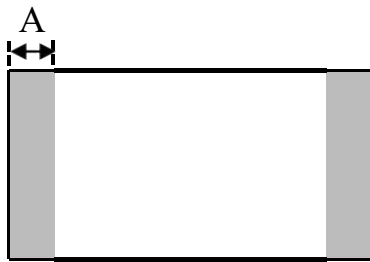

(Bottom View)



(Side View)

Symbols	L	W	T	A
Dimensions	1.60±0.20	0.80±0.20	0.80±0.20	0.30±0.10

地址： 深圳市宝安区西乡街道共乐社区铁仔路九方广场2栋1905
 Manufacturer: SHENZHEN HELIXUN TECHNOLOGY CO.LTD.
 TEL: 0755-23591525, FAX: 0755-23591525

Evaluation Board and Matching Circuits

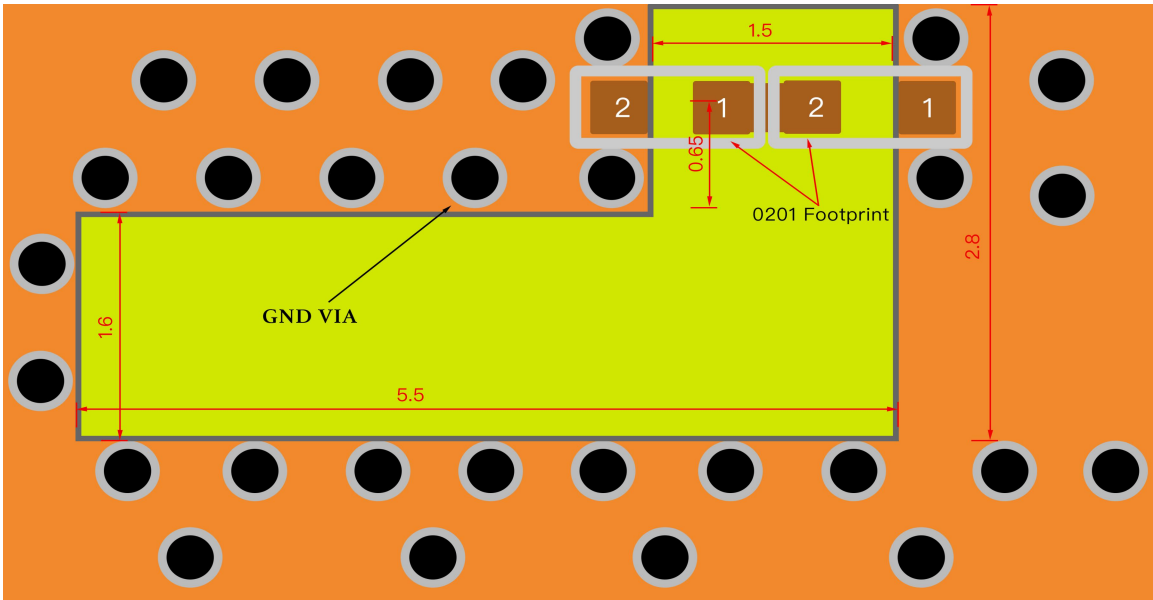
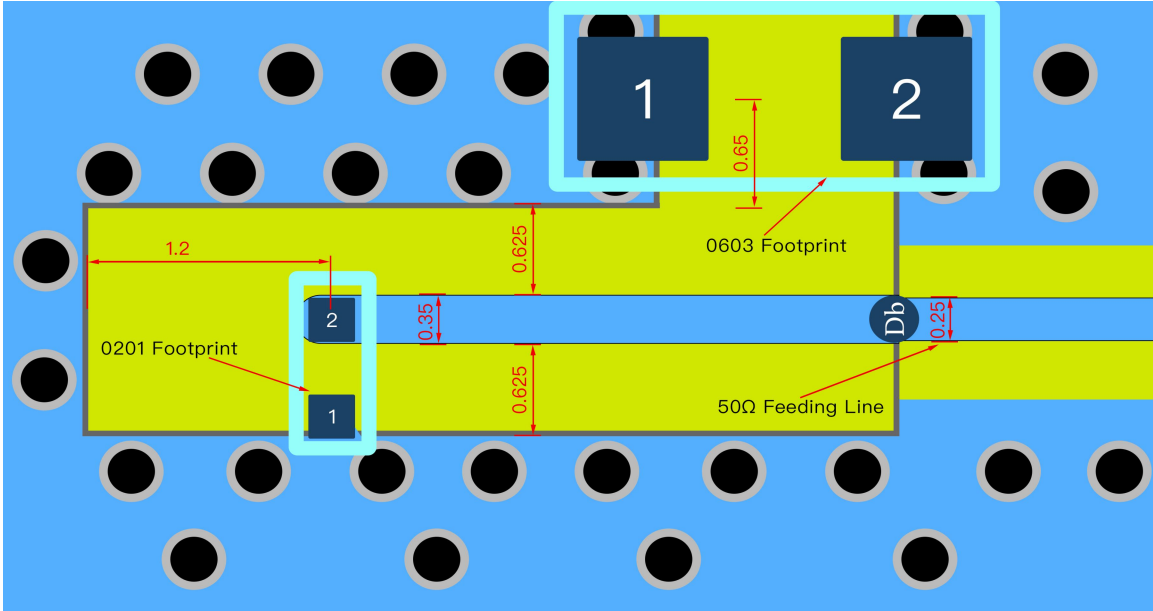

S11-Parameter



Frequency(MHz)	2400	2450	2480	2500
VSWR	1.56	1.16	1.48	1.79

地址：深圳市宝安区西乡街道共乐社区铁仔路九方广场2栋1905

Manufacturer: SHENZHEN HELIXUN TECHNOLOGY CO.LTD.

TEL: 0755-23591525, FAX: 0755-23591525

Radiation Pattern

coordinates:

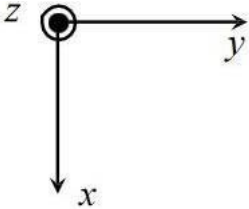

Y-Z Plane

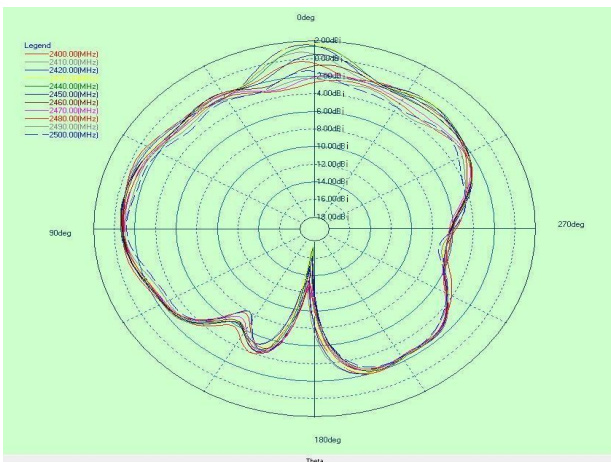

X-Z Plane

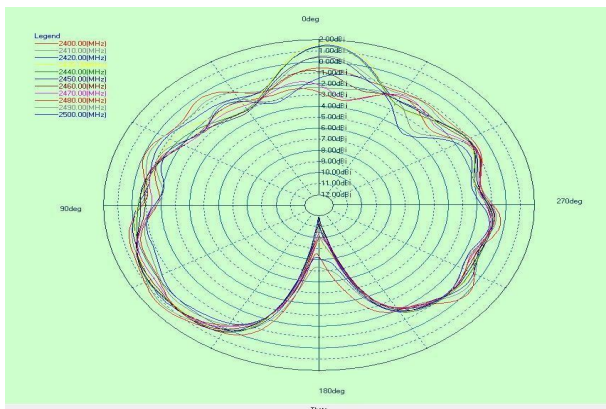

地址： 深圳市宝安区西乡街道共乐社区铁仔路九方广场2栋1905
Manufacturer: SHENZHEN HELIXUN TECHNOLOGY CO.LTD.
TEL: 0755-23591525, FAX: 0755-23591525

X-Y Plane

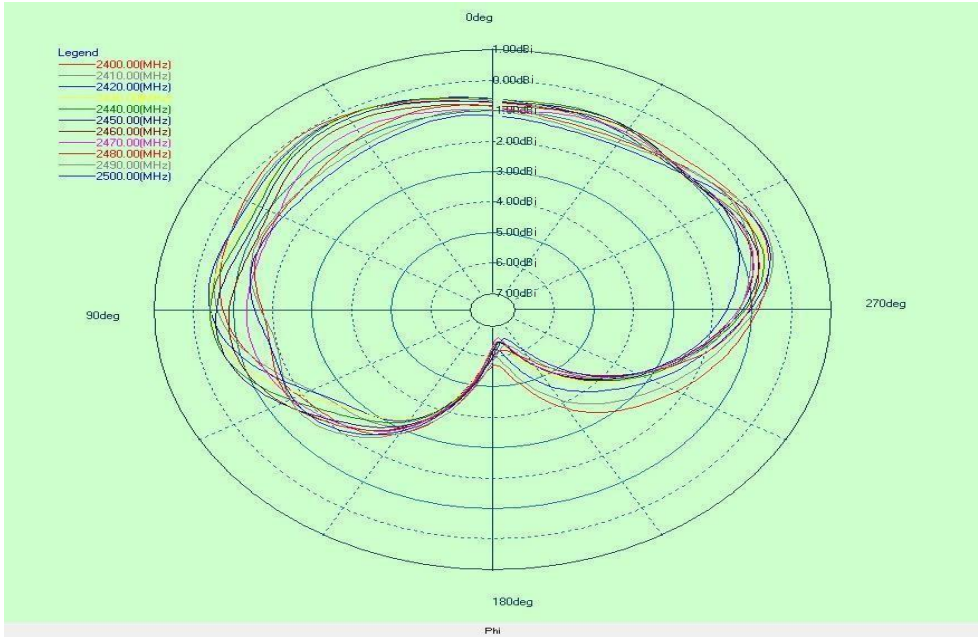

Frequency	2400MHz	2450MHz	2490MHz
Avg. gain dBi	1.30	0.93	0.45
Peak gain dBi	2.6	2.6	2.5
Efficiency dBi	57%	54%	53%

Dependability Test

	Test Temperature: 25°C±3°C
Operating Temperature	-25°C~+85°C
Temperature	5~40°C
Relative Humidity	20~70%

Moisture Proof

Temperature: 40±2°C Humidity: 90~95%RH

Duration: 500h

Recovery conditions: Room temperature Recovery Time: 24h (Class1) or 48h (Class2)

Solderability

At least 95% of the terminal electrode is covered by new solder. Preheating conditions: 80 to 120°C; 10~30s.

Solder Temperature: 235±5°C Duration: 2±0.5s, Solder Temperature: 245±5°C Duration: 2±0.5s

Optimum Solder Amount for Reflow Soldering

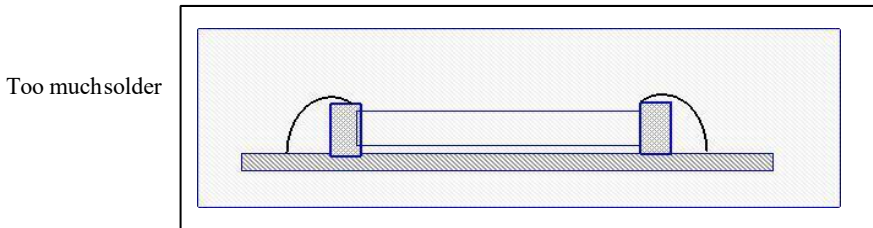

Cracks tend to occur due to large stress.

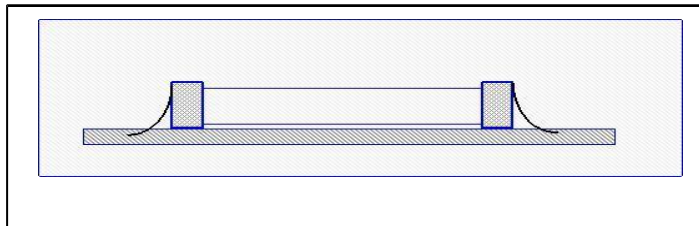

Weak holding force may cause bad connection between the capacitor and PCB.

Recommended Soldering amounts

The optimal solder fillet amounts for re-flow soldering

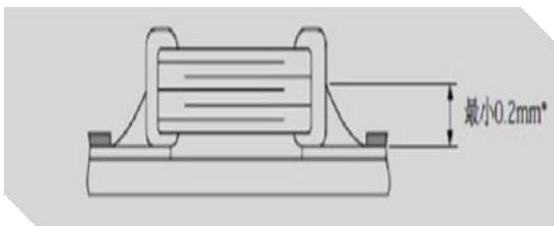

The optimal solder fillet amounts for wavesoldering

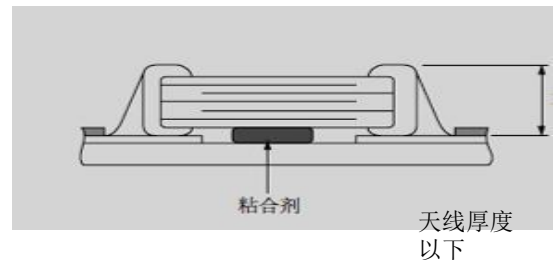

地址：深圳市宝安区西乡街道共乐社区铁仔路九方广场2栋1905

Manufacturer: SHENZHEN HELIXUN TECHNOLOGY CO.LTD.

TEL: 0755-23591525, FAX: 0755-23591525

Temperature Cycle Test

10±1S Applied Force: 5N Duration: 10±1S

Preheating conditions: up-category temperature, 1h

Recovery time: 24±1h

Initial Measurement

Cycling Times: 5 times, 1 cycle, 4 steps:

阶段	温度 (°C)	时间 (分钟)
第1步	下限温度(NPO/X7R/X7S/X6S/X5R-55) Y5V-25 Z5U-10	30
第2步	常温 (+20)	2~3
第3步	上限温度(NPO/X7R/X7S-125) Y5V/Z5U/X5R-85 X6S-105	30
第4步	常温 (+20)	2~3

Resistance to Soldering Heat

Preheating 80 to 120°C; 10~30s. Solder Temperature: 235±5°C Duration: 2±0.5s, Solder Temperature: 245±5°C Duration: 2±0.5s, Preheating 100 to 200°C; 10±2min.

Solder Temperature: 265±5°C Duration: 10±1s

Clean the capacitor with solvent and examine it with a 10X(min.) microscope.

Recovery Time: 24±2h

Recovery condition: Room temperature

Resistance to Flexure of Substrate

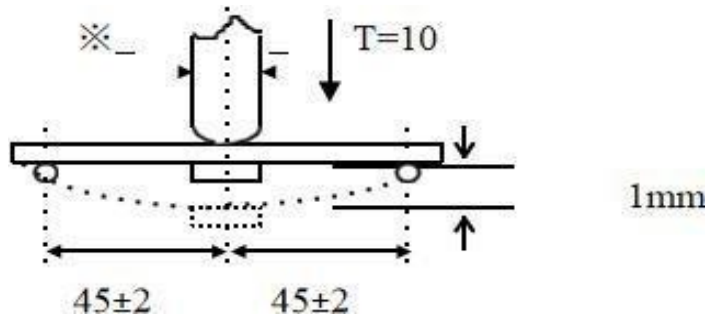

Test Board: Al₂O₃ or PCB Warp: 1mm Speed: 0.5mm/sec.
Unit: mm

The measurement should be made with the board in the bending position.

地址：深圳市宝安区西乡街道共乐社区铁仔路九方广场2栋1905

Manufacturer: SHENZHEN HELIXUN TECHNOLOGY CO.LTD.

TEL: 0755-23591525, FAX: 0755-23591525

The temperature profile for soldering

Re-flow soldering

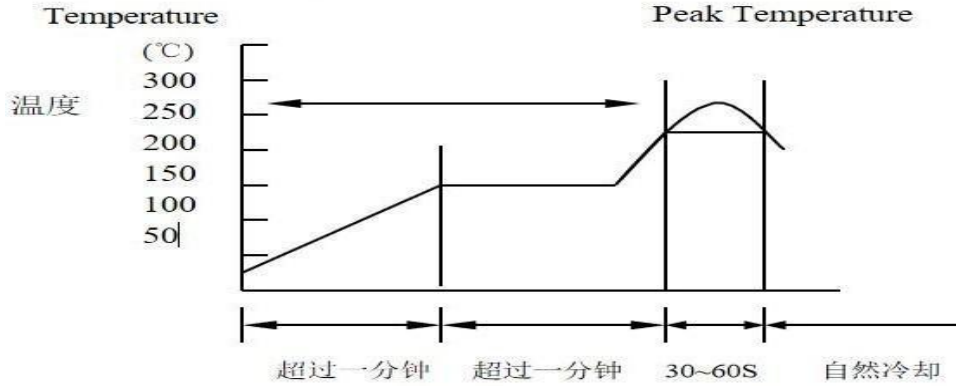

	Pb-Sn 焊接 Pb-Sn soldering	无铅焊接 Lead-free soldering
尖峰温度 Peak temperature	230°C~250°C	240°C~260°C

While in preheating, please keep the temperature difference between soldering temperature and surface temperature of chips as: $T \leq 150^{\circ}\text{C}$.

Wave soldering

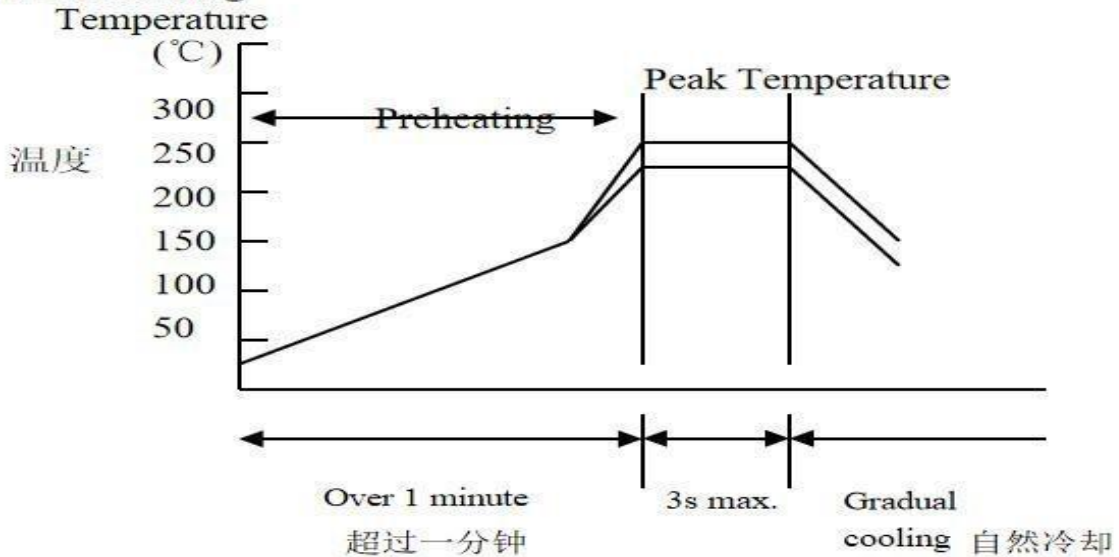

	Pb-Sn 焊接 Pb-Sn soldering	无铅焊接 Lead-free soldering
尖峰温度 Peak temperature	230°C~260°C	240°C~270°C

地址：深圳市宝安区西乡街道共乐社区铁仔路九方广场2栋1905
 Manufacturer: SHENZHEN HELIXUN TECHNOLOGY CO.LTD.

TEL: 0755-23591525, FAX: 0755-23591525

Dimensions of paper taping for 0603 types

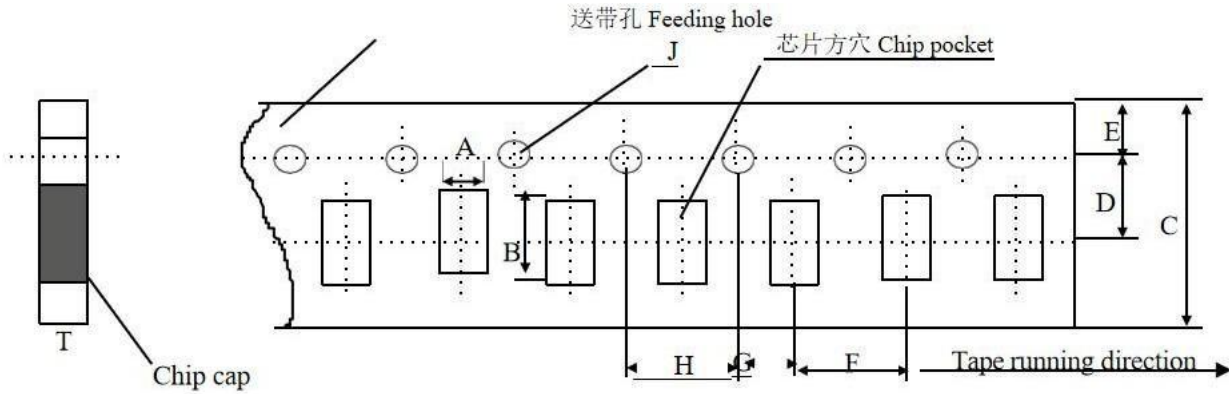

Unit: mm

代号 Code 纸带规格 papersize	A	B	C	D*	E	F	G*	H	J	T
0603	1.10 ±0.10	1.90 ±0.10	8.00 ±0.10	3.50 ±0.05	1.75 ±0.10	4.00 ±0.10	2.00 ±0.10	4.00 ±0.10	1.50 -0/+0.10	1.10 Max

Reel (4000 pcs/Reel)

Note: The place with * means where needs exactly dimensions.

EMBOSED TAPING

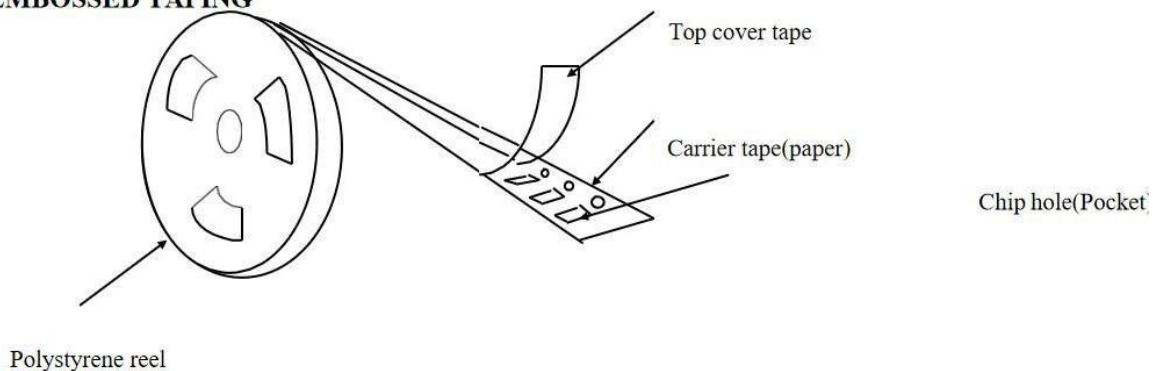

Storage Period

The guaranteed period for solderability is 6 months (Under deliver package condition). Temperature 5~40°C /Relative Humidity 20~70%

地址： 深圳市宝安区西乡街道共乐社区铁仔路九方广场2栋1905

Manufacturer: SHENZHEN HELIXUN TECHNOLOGY CO.LTD.

TEL: 0755-23591525, FAX: 0755-23591525