



Model:C6604-A



Download Free APP:



Smart Life



Download on the App Store



GET IT ON Google Play



Thank you for choosing the C6604-A. In order to optimize the user experience, please read this manual carefully before operation, and keep this manual properly for future use.

Warning:

1. This product is not a toy. To avoid fire, burns, personal injury or electric shock, please install out of the reach of children.
2. In order to ensure the normal operation of the lamp, please use the voltage indicated on the package.
3. Please do not modify the lamps during the warranty period.
4. Do not install near gas or electric heaters, fires, candles or any dangerous objects.
5. Before installation, please check whether the lamps and various parts are in good condition.
6. Be sure to cut off the power before installation.
7. Do not expose the lamp to corrosive conditions.
8. If the power cord is damaged, please cut off the power immediately and stop using it.

Technical Specification:

Connection method:Bluetooth Mesh

Control method: APP/Voice/Button

Adapter input voltage:120VAC

Adapter output voltage: 24VDC/0.35A

Rated working voltage: DC24V

Rated power: 8W+8W

Lamp color: RGBCW

Color temperature:2200K-6500K

Control method: PWM

Memory function: yes

Working temperature: -20°C~+40°C

Protection class of lamps and controllers:IP67

Work with Amazon Alexa and Google Assistant.(connect via gateway)

Packinglist:

1. Landscape lights * 1
2. Ground plug *1
3. 3m extension cord * 1
4. Gecko Screw Pack * 1
5. Power supply* 1
6. T-Connector * 1
7. Copy of the manual * 1



Dimension Data:

Wiring method 1:

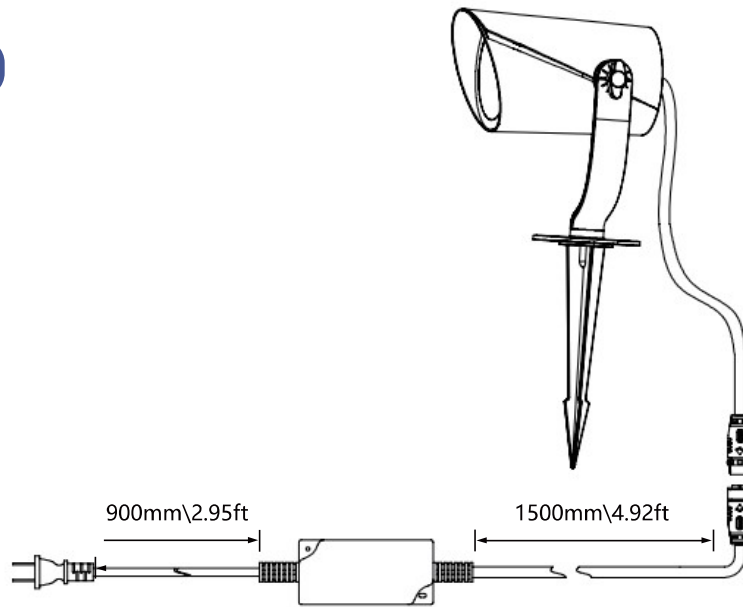

Wiring method 2:

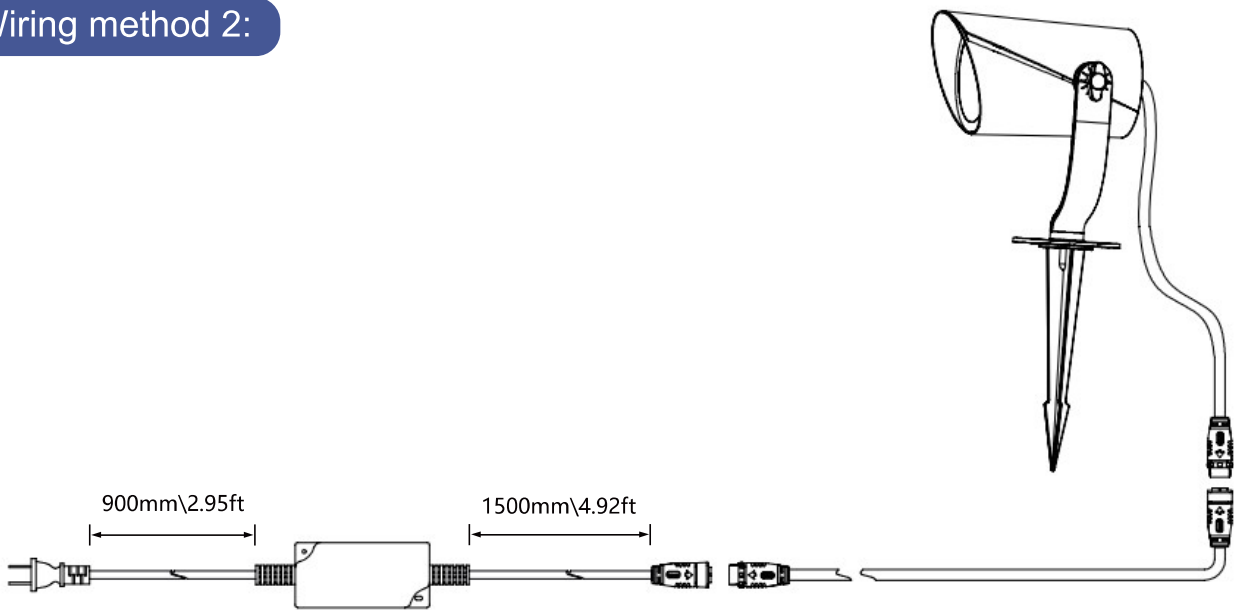

Wiring method 3:

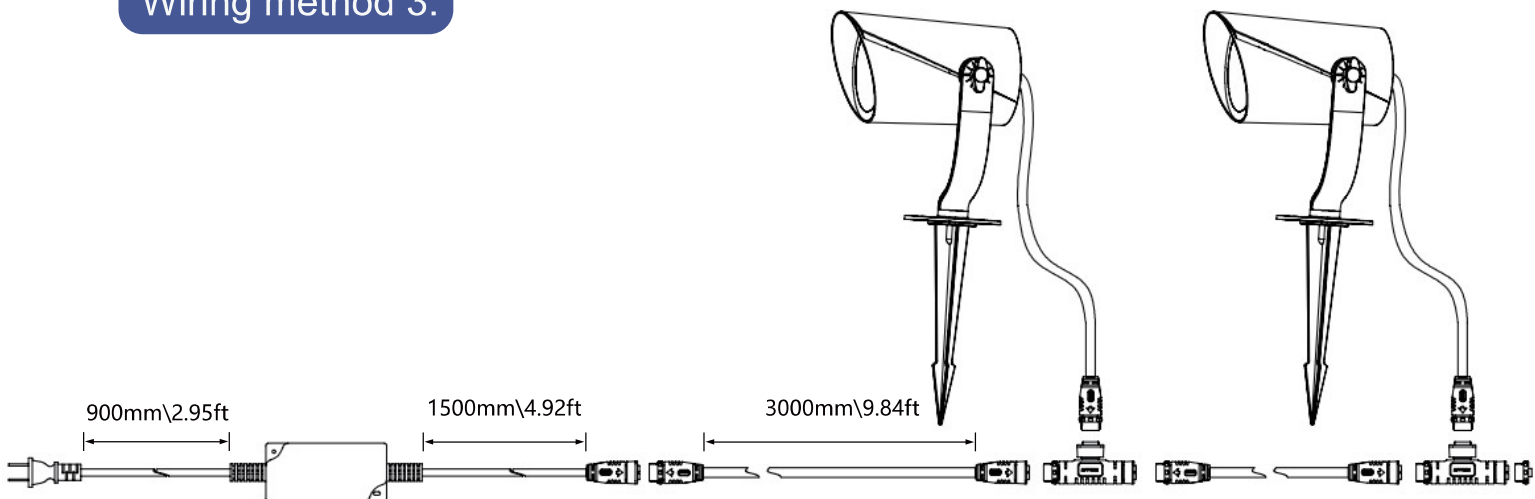

Installation Method:

Installation method 1:

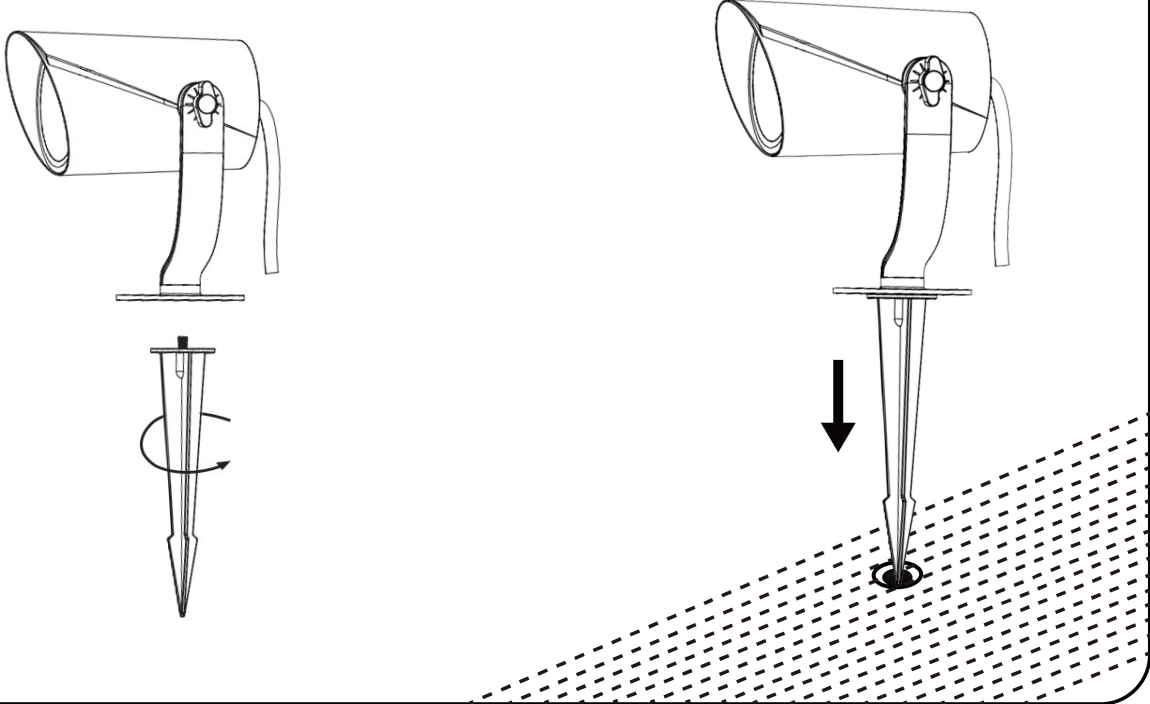

Installation method 2:

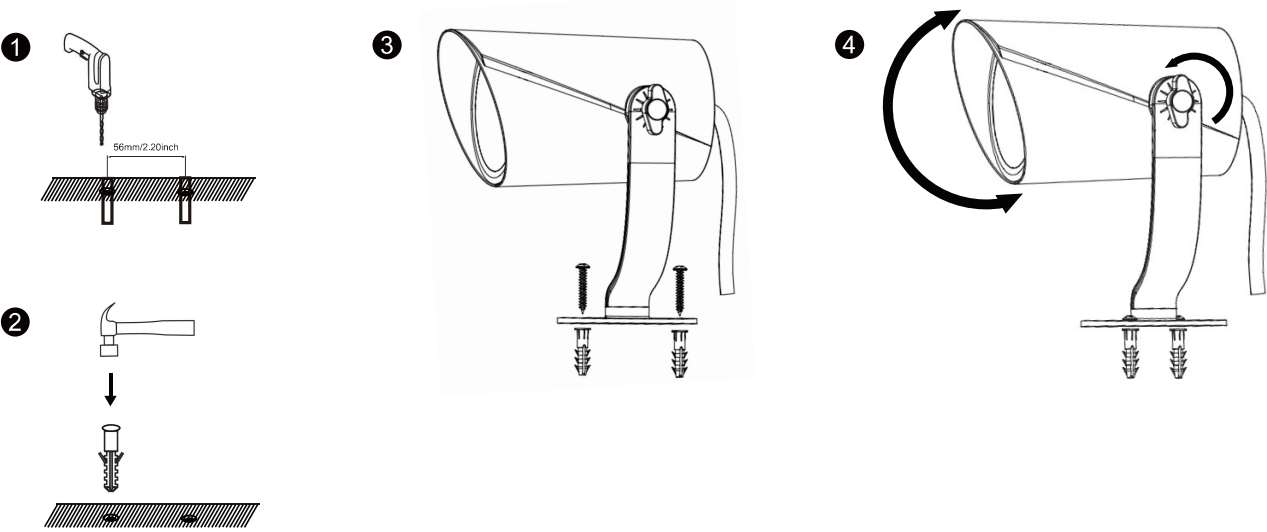

APP Intelligent operation introduction:

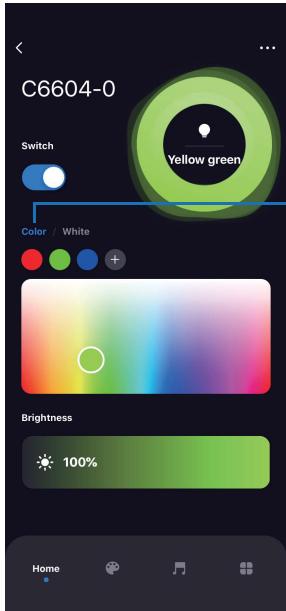

Color light switch

Color adjustment
Tap + to add selected color, long press color dot to delete.

Color Brightness Adjustment

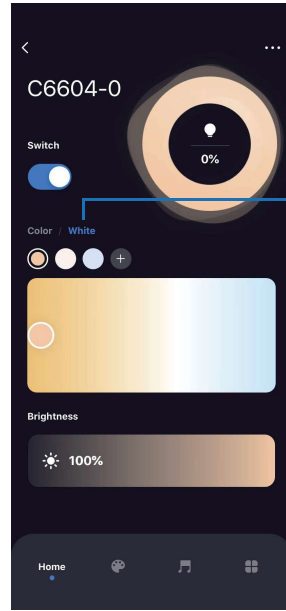

white light switch

Color adjustment
Tap + to add selected color, long press color dot to delete.

Color Brightness Adjustment

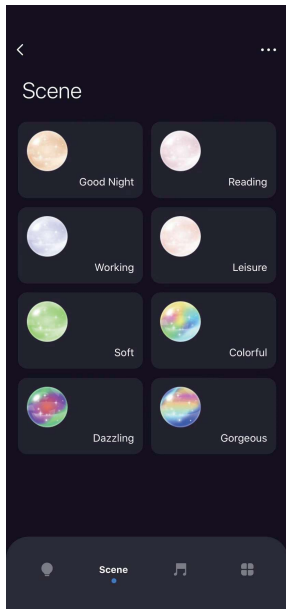

Multiple scene modes

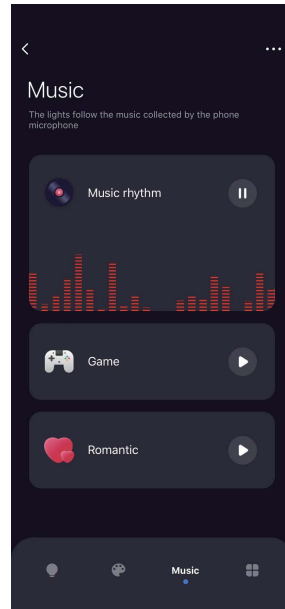

music mode:
Freely switch music according to the scene

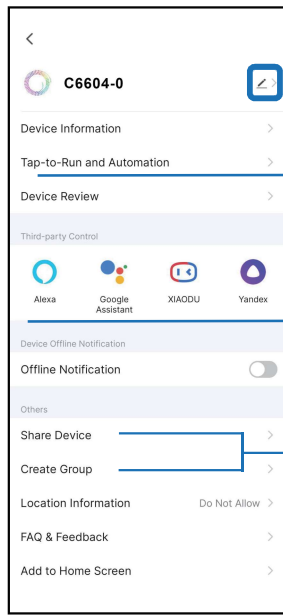
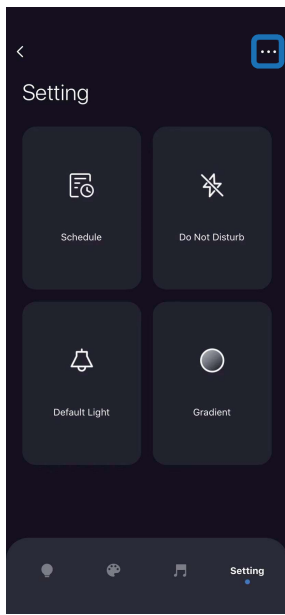

Click ... from other page to enter to device page. Click pen icon to rename the device.

Timer: Set the device off in given time. Schedule: Set the device on or off in specified time.

Control via Alexa or Google Assistant

Share the device to other people or controlling. Create a group to control multiple devices.

Pairing Instruction:

APP Download. Search the **Smart Life** from Google Play or App Store. You can also scan the QR code from below.

1. Download the APP and **Log In** with existing account or **Sign Up** the new account.

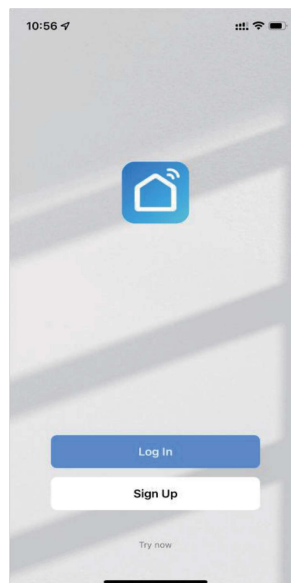

2. Turn on the phone's bluetooth.

3. Tap **Add Device** or the plus icon (+) in the top-right corner on the **Home** page to go to the device adding page.

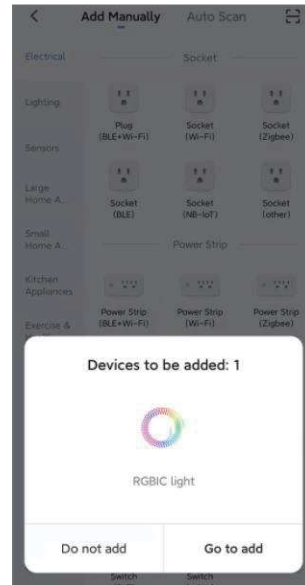
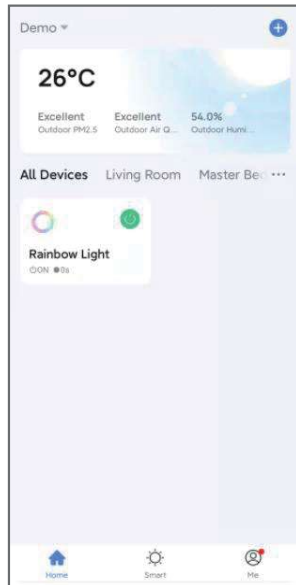

4. Wait about twenty seconds and the device will be added completely.

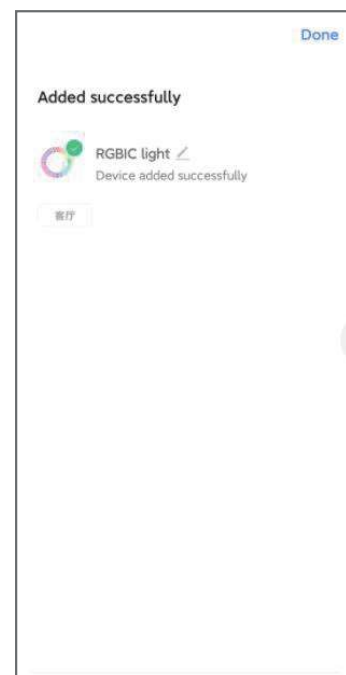
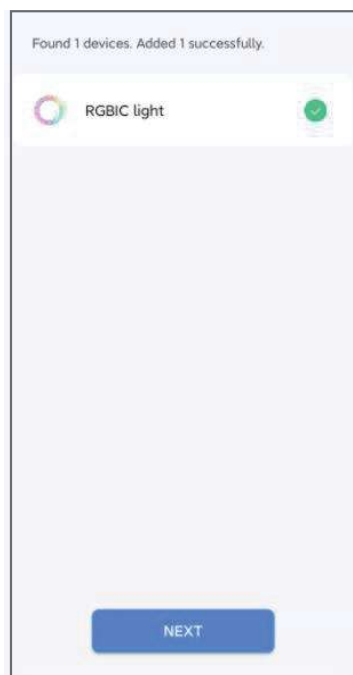
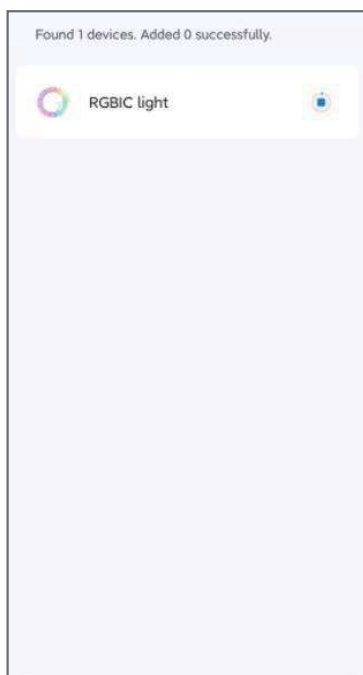

5. Then the device can be found in home page. Now you can play it with your imagination.

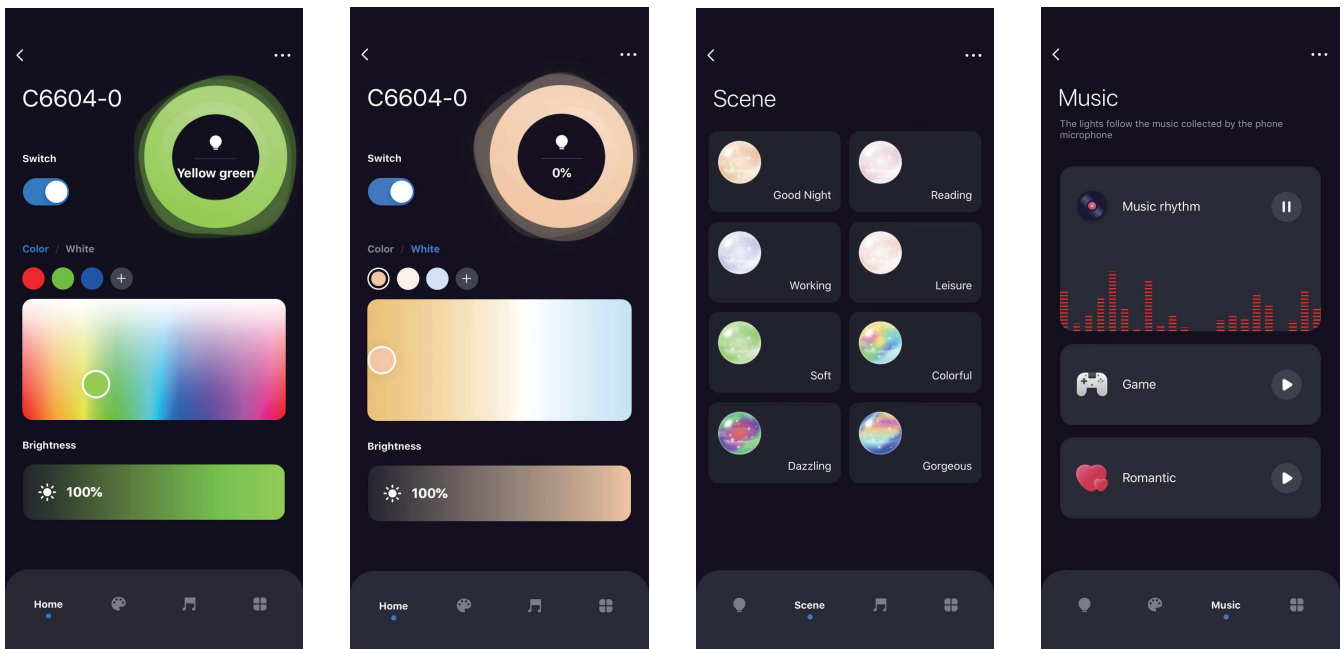

6. Click the edit icon in the upper right corner to show more gameplay.

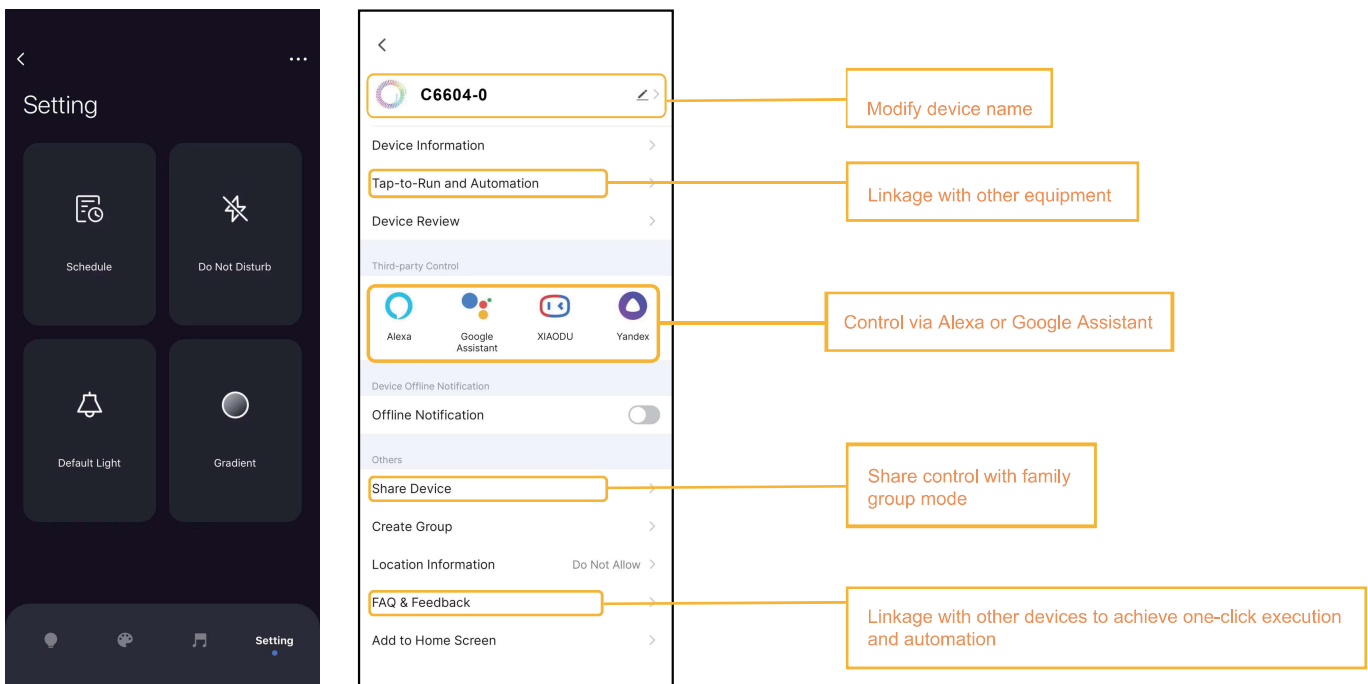

Common problems and solutions

1. Unable to connect to your device.

(1) Please confirm that the Bluetooth of the mobile phone is turned on, and the lamp is powered on normally.

(2) The installer works fine.

2. The installer is not working properly, please confirm that the Bluetooth of the mobile phone is turned on and the light is working normally.

(1) Then close all applications running in the background and reopen the Smart Life APP.

(2) Uninstall and reinstall the Smart Life app and repeat.

3. The smart light strip is not responding.

(1) Check whether the smart string light is turned off. If yes, turn them on and wait until the smart light strip reconnects to The wireless network works automatically.

(2) Check that your phone's bluetooth is turned on.

Guarantee:

1. During the warranty period, we provide services including refunds or free replacement for those who use the device for its intended purpose.

2. This warranty does not include:

(1) Malfunction or damage caused by improper use, repair or modification.

(2) Failure or damage due to falling.

(3) Failure or damage caused by fire, earthquake, flood, lightning and other natural disasters.

(4) Malfunction or damage when used other than for its intended purpose.

(5) Failure or damage caused by third-party products.

(6) Failure or damage to the product caused by human factors.

FCC Warning:

This device complies with part 15 of the FCC Rules. Operation is subject to the following two conditions:

- (1) This device may not cause harmful interference
- (2) this device must accept any interference received, including interference that may cause undesired operation.

Note: This equipment has been tested and found to comply with the limits for a Class B digital device, pursuant to part 15 of the FCC Rules. These limits are designed to provide reasonable protection against harmful interference in a residential installation. This equipment generates, uses and can radiate radio frequency energy and, if not installed and used in accordance with the instructions, may cause harmful interference to radio communications. However, there is no guarantee that interference will not occur in a particular installation. If this equipment does cause harmful interference to radio or television reception, which can be determined by turning the equipment off and on, the user is encouraged to try to correct the interference by one or more of the following.

Measures:

- Reorient or relocate the receiving antenna.
- Increase the separation between the equipment and receiver.
- Connect the equipment into an outlet on a circuit different from that to which the receiver is connected.
- Consult the dealer or an experienced radio/TV technician for help.

Note: The Grantee is not responsible for any changes or modifications not expressly approved by the party responsible for compliance. such modifications could void the user's authority to operate the equipment.

The device has been evaluated to meet general RF exposure requirement. To maintain compliance with FCC's RF exposure guidelines, the distance must be at least 20 cm between the radiator and your body, and fully supported by the operating and installation configurations of the transmitter and its antenna(s).

MADE IN CHINA