

Antenna test report

Test Laboratory	Dongguan Yijia Electronic Co., LTD
Address	No. 59 Muyu Road, Shatou Community, Chang 'an Town, Dongguan City, Guangdong Province
Contact:	Mr. Gan 13823198410
Model	H6097

1. Test procedures

Name	Parameter	Method	Standard No.
Mobile communication antenna	VSWR	Generic specification for antennas used in the mobile communications	GB/T 9410-2008
	Antenna Gain		
	Radiation pattern		
Antenna	Radiation efficiency	IEEE Standard Test Procedures for Antennas	ANSI/IEEE Std 149-1979

2. Test Equipment

Equipment	Model No.	Serial No.	Manufacture	Calibration Date	Next calibration Date
24 probe Microwave chamber	MPS2450 Multi-probe OTA measurement systems 5*5*5	YJ-PB-F01	XH-IOE	2023.09.01	2024.09.01
Network Analyzer	ZVB8	YJ-RD-15	ROHDE&SCHWARS	2023.08.25	2024.08.25
Wideband radio Communication tester	CMW500	YJ-RD-16	ROHDE&SCHWARS	2023.08.25	2024.08.25

3. DUT Setup Photo

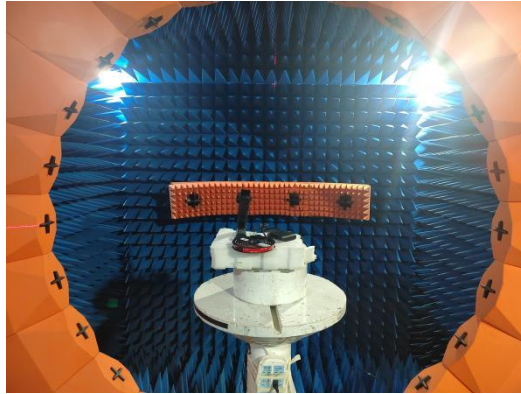
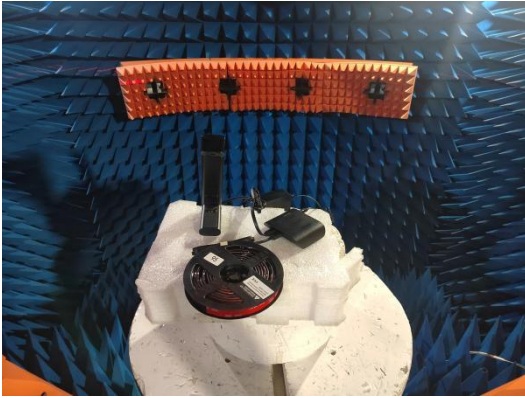

4. Bluetooth Antenna Physical Size

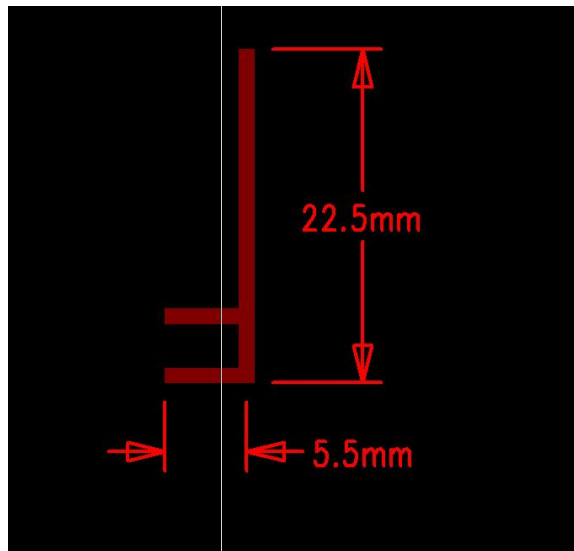

5. Bluetooth Antenna Type & Gain

Type: PCB

Frequency / MHz	BT Gain/ dBi
2400	3
2410	3.18
2420	3.09
2430	2.99
2440	2.72
2450	3.11
2460	2.57
2470	3.04
2480	2.84
2490	3.17
2500	2.77

BT:

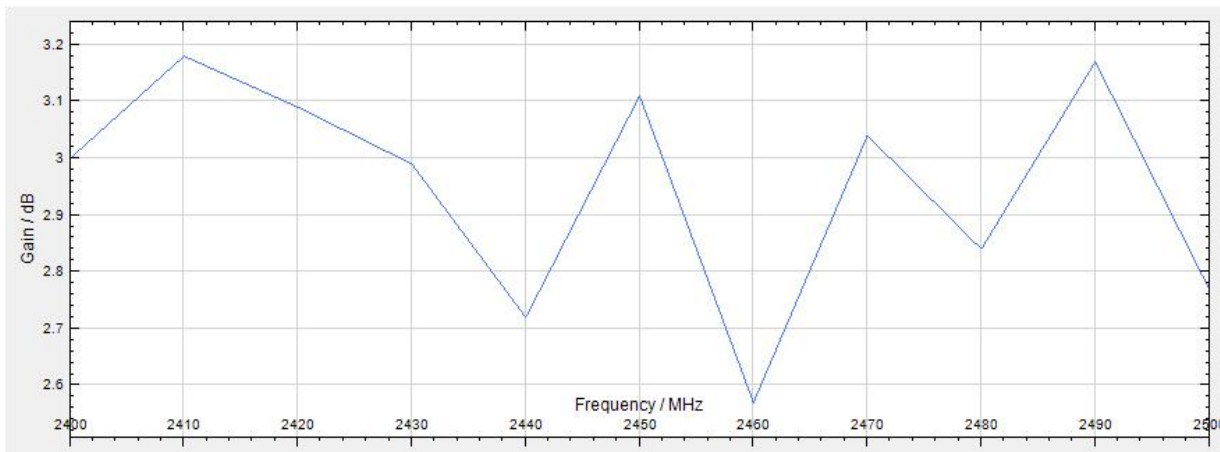

6. Bluetooth Antenna Pattern Picture

2400MHz

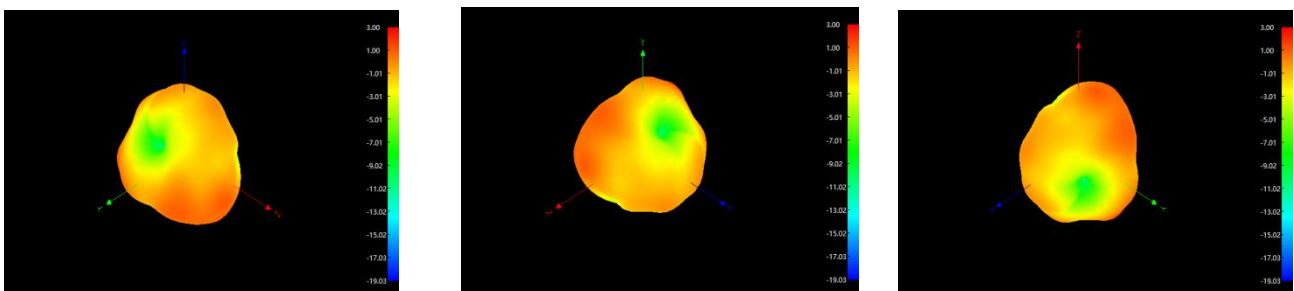

2450MHz

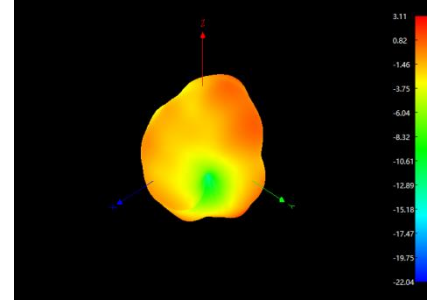
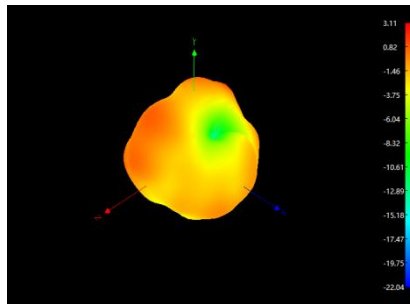
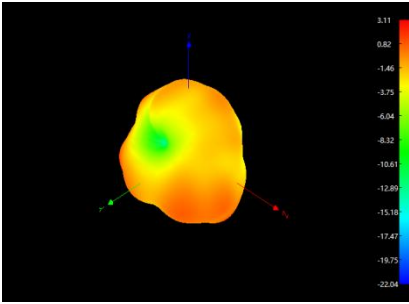

2500MHz

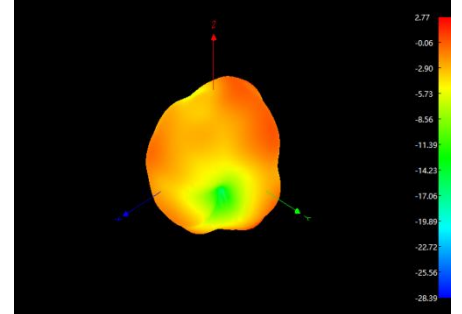
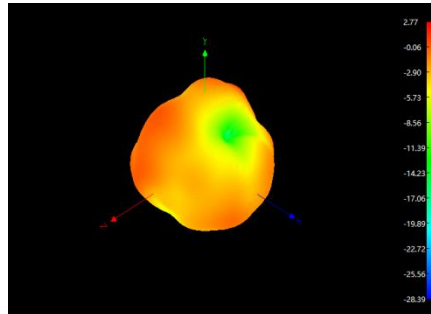
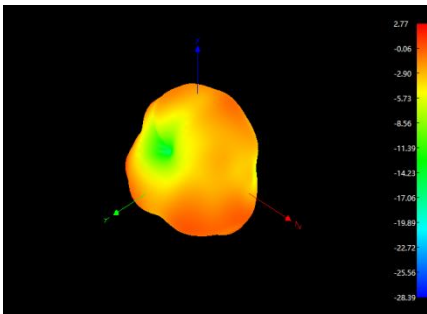

Tester by: Wu xianming

Wu Xianming