

## Antenna test report

<b>Test Laboratory</b>	Dongguan Yijia Electronic Co., LTD
<b>Address</b>	No. 59 Muyu Road, Shatou Community, Chang 'an Town, Dongguan City, Guangdong Province
<b>Contact:</b>	Mr. Gan 13823198410
<b>Model</b>	H7143

### 1. Test procedures

<b>Name</b>	<b>Parameter</b>	<b>Method</b>	<b>Standard No.</b>
Mobile communication antenna	VSWR	Generic specification for antennas used in the mobile communications	GB/T 9410-2008
	Antenna Gain		
	Radiation pattern		
Antenna	Radiation efficiency	IEEE Standard Test Procedures for Antennas	ANSI/IEEE Std 149-1979

### 2. Test Equipment

<b>Equipment</b>	<b>Model No.</b>	<b>Serial No.</b>	<b>Manufacture</b>	<b>Calibration Date</b>	<b>Next calibration Date</b>
24 probe Microwave chamber	MPS2450 Multi-probe OTA measurement systems 5*5*5	YJ-PB-F01	XH-IOE	2022.09.01	2023.09.01
Network Analyzer	ZVB8	YJ-RD- 15	ROHDE& SCH WARS	2022.08.25	2023.08.25
Wideband radio Communication tester	CMW500	YJ-RD- 16	ROHDE& SCH WARS	2022.08.25	2023.08.25

### 3. DUT Setup Photo

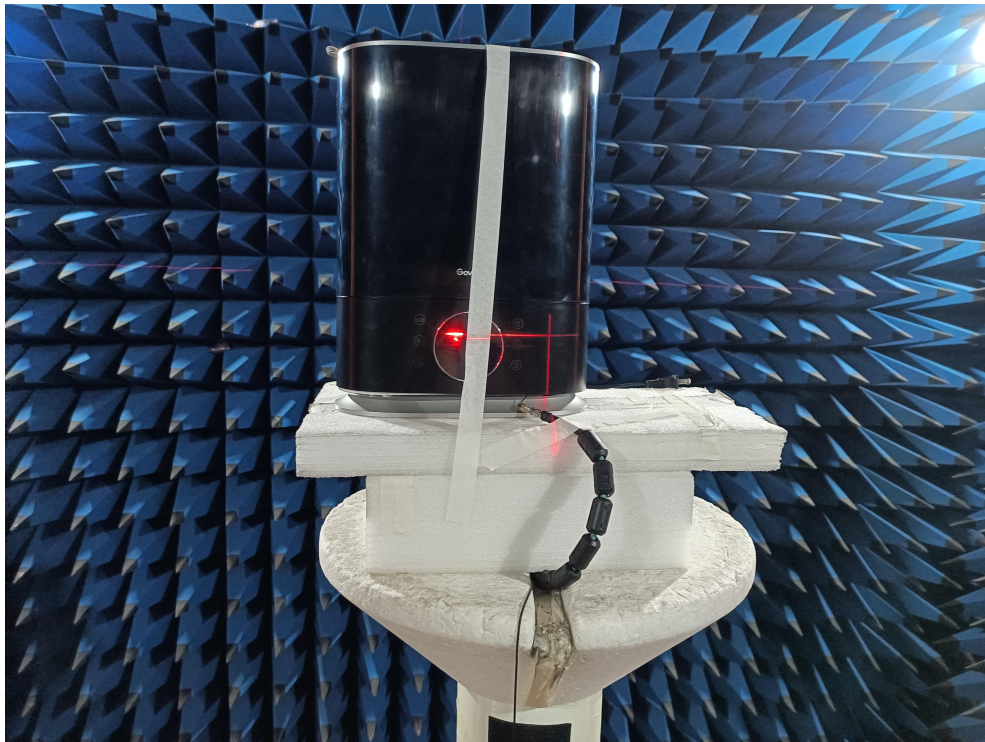
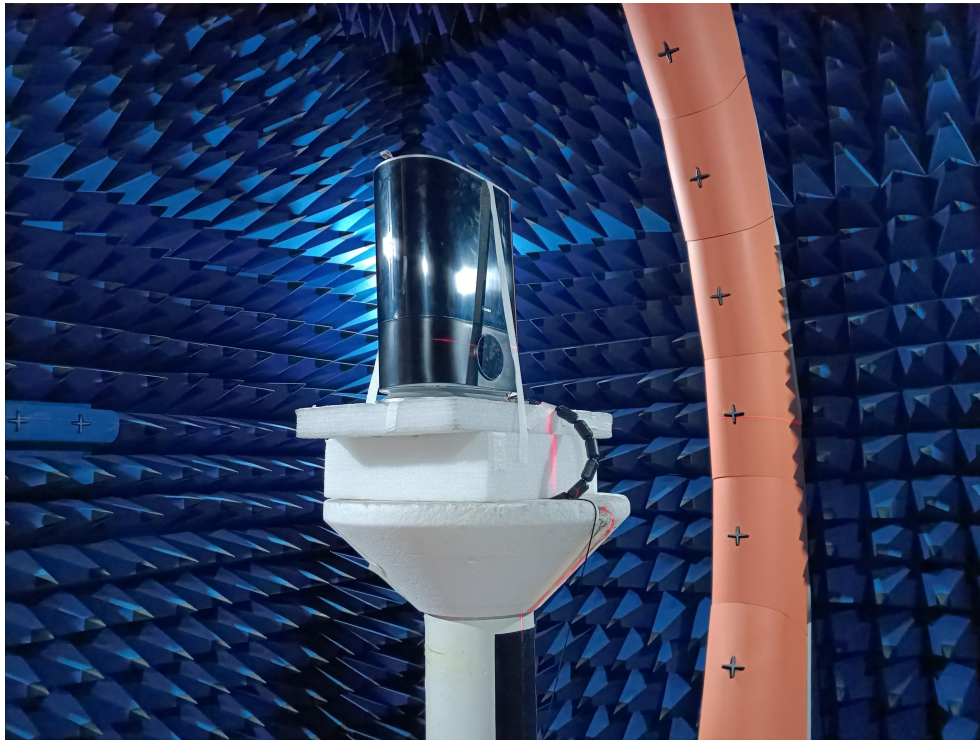

### 4. Bluetooth & Wi-Fi Antenna Physical Size

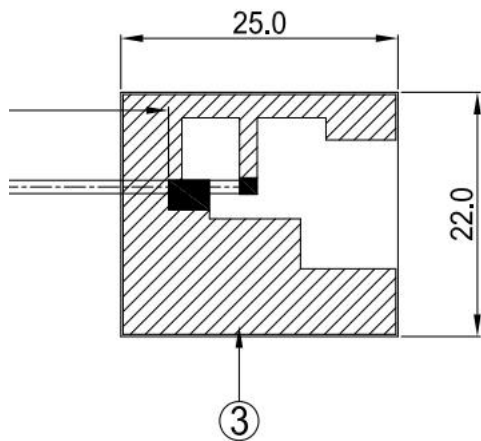

## 5. Bluetooth & Wi-Fi Antenna Type & Gain

**Type: FPC Antenna**

Frequency / MHz	Gain/ dBi
2400	3.42
2410	3.23
2420	3.10
2430	3.09
2440	2.97
2450	3.07
2460	2.91
2470	2.97
2480	2.77
2490	2.79
2500	2.43

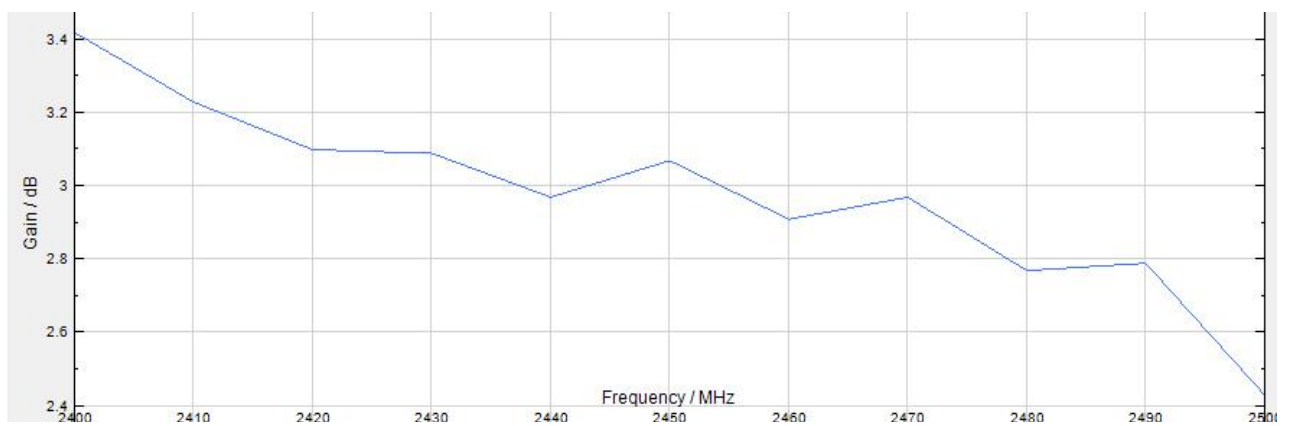

## 6. Bluetooth Antenna Pattern Picture

2400MHz

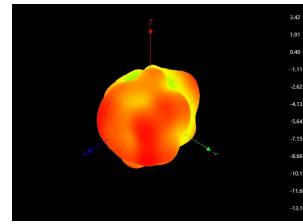
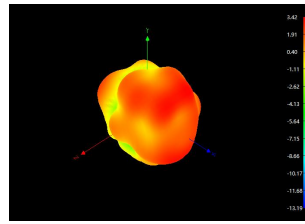
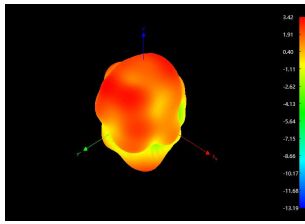

2450MHz

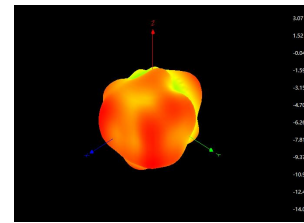
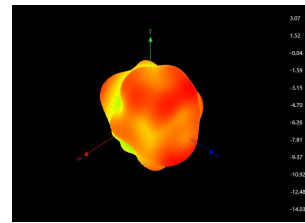
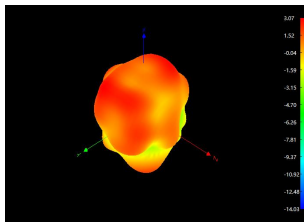

2500MHz

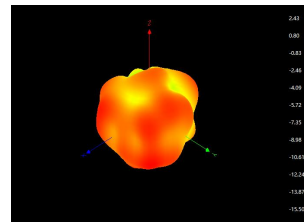
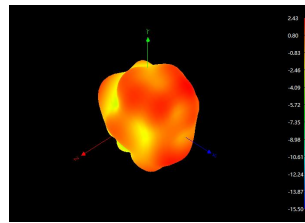
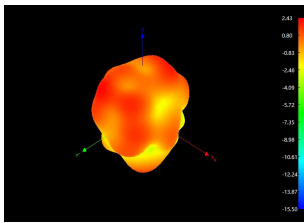

Tester by: Wu xianming

Wu Xianming