

# GoveeLife

Model: H7126

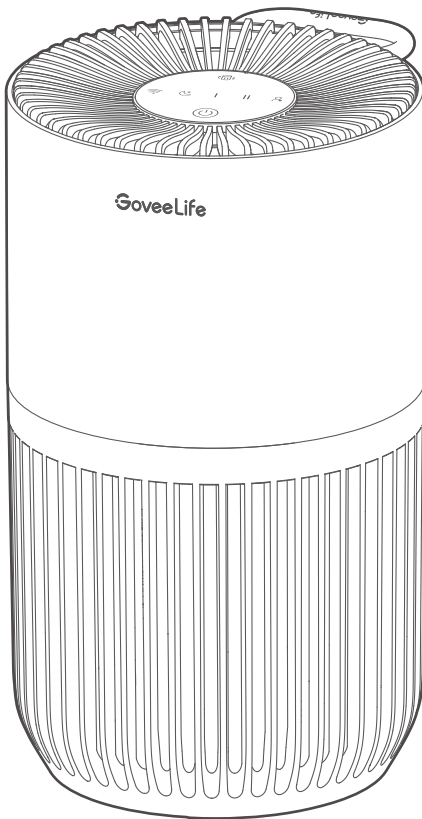

## User Manual

GoveeLife Smart Mini Air Purifier

# Contents

<b>READ AND SAVE THESE INSTRUCTIONS</b>	<b>01</b>
<b>LIRE ET ENREGISTRER CES INSTRUCTIONS</b>	<b>02</b>
<b>Included in the Box</b>	<b>03</b>
<b>Introduction</b>	<b>04</b>
<b>Getting Started</b>	<b>06</b>
<b>Govee Home App</b>	<b>07</b>
<b>Using the Filters</b>	<b>08</b>
<b>Care &amp; Maintenance</b>	<b>10</b>
<b>Storing</b>	<b>11</b>
<b>Troubleshooting</b>	<b>12</b>
<b>Appendix</b>	<b>15</b>

# READ AND SAVE THESE INSTRUCTIONS

## Safety Instructions

### General Safety

- Only use the air purifier as described in this manual.
- Do not use the air purifier without removing the plastic wrap from the filter. If not removed, the air purifier will not filter air, and may overheat, causing a fire hazard.
- Do not use the air purifier outdoors.
- Keep the air purifier away from water or wet, damp areas. Never submerge it in water or liquid.
- Do not use the air purifier in excessively humid areas.
- Keep the air purifier away from heat sources such as stovetops, ovens, or radiators.
- Do not use the air purifier in places where combustible gases, vapors, metallic dust, aerosol (spray) products, or fumes from industrial oil are present.
- Keep the air purifier 5ft (1.5m) away from where oxygen is being administered.
- Supervise children when they are near the air purifier.
- Do not place anything into the openings of the air purifier.
- Do not place heavy objects on the air purifier.
- Keep the inside of the air purifier dry. To prevent moisture build up, avoid placing it in rooms with major temperature changes or underneath air conditioners.
- Always unplug the air purifier before servicing (such as changing the filter).
- Do not use the air purifier if it is damaged or not functioning well, or if the cord or adapter is damaged. Do not risk repairing the air purifier by yourself. Contact Customer Support for assistance.
- Not for commercial use. Household use only.

**WARNING:** To Reduce The Risk Of Fire Or Electric Shock, Do Not Use This Air Purifier With Any Solid-State Speed Control Device.

### Power Adapter & Cord

- Place the air purifier near the electrical outlet it is plugged into.
- Never place the cord near any heat sources.
- Do not cover the cord with a rug, carpet, or other covering. Do not place the cord under furniture or appliances.
- Keep the cord out of areas where people frequently move around. Place the cord in places where it will not be tripped over.
- This air purifier uses standard US 120V, 60Hz outlets. If using it outside the US, check the compatibility.

- This appliance has a polarized plug (one blade is wider than the other). To reduce the risk of electric shock, this plug is intended to fit in a polarized outlet only one way. If the plug does not fit fully in the outlet, reverse the plug. If it still does not fit, contact a qualified electrician. Do not attempt to defeat this safety feature.
- If the power adapter cord is damaged, it must be replaced by qualified persons in order to avoid an electric or fire hazard. Please contact Customer Support.

## LIRE ET ENREGISTRER CES INSTRUCTIONS

### Consignes de sécurité

#### Sécurité générale

- Utilisez uniquement le purificateur d'air selon la description donnée dans ce manuel.
- N'utilisez pas le purificateur d'air sans retirer le film plastique du filtre. S'il n'est pas retiré, le purificateur d'air ne filtrera pas l'air et pourrait surchauffer, provoquant un risque d'incendie.
- N'utilisez pas le purificateur d'air à l'extérieur.
- Éloignez le purificateur d'air de l'eau ou des zones mouillées et humides. Ne le plongez jamais dans de l'eau ou dans un liquide.
- N'utilisez pas le purificateur d'air dans des zones excessivement humides.
- Éloignez le purificateur d'air des sources de chaleur telles que les plaques de cuisson, les fours ou les radiateurs.
- N'utilisez pas le purificateur d'air dans des endroits où se trouvent des gaz ou des vapeurs combustibles, de la poussière métallique, des produits en aérosol (spray) ou des fumées d'huile industrielle.
- Maintenez le purificateur d'air à 5 pi (1,5 mètres) de l'endroit où l'oxygène est administré.
- Surveillez les enfants lorsqu'ils se trouvent à proximité du purificateur d'air.
- Ne placez rien dans les ouvertures du purificateur d'air.
- Ne placez pas d'objets lourds sur le purificateur d'air.
- Gardez l'intérieur du purificateur d'air sec. Pour éviter l'accumulation de l'humidité, évitez de le placer dans des pièces présentant des changements de température importants ou sous des climatiseurs.
- Débranchez toujours le purificateur d'air avant l'entretien (par exemple le remplacement du filtre).
- N'utilisez pas le purificateur d'air s'il est endommagé ou ne fonctionne pas correctement, ou si le cordon ou l'adaptateur est endommagé. Ne prenez pas le risque de réparer vous-même le purificateur d'air. Contactez le service client pour obtenir de l'aide.
- Non destiné à un usage commercial. Usage domestique uniquement.

**AVERTISSEMENT :** Pour réduire le risque d'incendie ou d'électrocution, n'utilisez pas ce purificateur d'air avec un appareil de commande de vitesse à semi-conducteurs.

#### Adaptateur secteur et cordon

- Placez le purificateur d'air à proximité de la prise électrique sur laquelle il est branché.
- Ne placez jamais le cordon à proximité de sources de chaleur.

- Ne couvrez pas le cordon avec un tapis, une moquette ou tout autre revêtement. Ne placez pas le cordon sous des meubles ou des appareils électroménagers.
- Éloignez le cordon des zones où les gens se déplacent fréquemment. Placez le cordon dans des endroits où il ne risque pas de faire trébucher.
- Ce purificateur d'air utilise des prises conformes aux normes américaines de 120 V, 60 Hz. Si vous l'utilisez en dehors des États-Unis, vérifiez la compatibilité.
- Cet appareil est équipé d'une fiche polarisée (une lame est plus large que l'autre). Afin de réduire le risque de choc électrique, cette fiche est conçue pour être insérée dans une prise polarisée dans un seul sens. Si la fiche ne peut être complètement insérée dans la prise, inversez la fiche. Si l'insertion ne peut toujours être effectuée, contactez un électricien qualifié. N'essayez pas de contourner ce dispositif de sécurité.
- Si le cordon de l'adaptateur secteur est endommagé, il doit être remplacé par des personnes qualifiées afin d'éviter tout risque de panne électrique ou d'incendie. Veuillez contacter le service client.

## Included in the Box

Item	Quantity
Smart Mini Air Purifier	1
HEPA Filter (Pre-Installed)	1
Aroma Pad	1 (In the Aroma Box) 2 (External)
Power adapter	1
Quick Start Guide	1
User Manual	1

# Introduction

## Part Names

- a. Air Outlet
- b. Touch Control Panel
- c. Fixing Bracket
- d. Handle
- e. Aroma Pad
- f. Aroma Box
- g. DC Input Port
- h. Housing
- i. Air Inlet
- j. 3-in-1 HEPA Filter
- k. Adapter Output Cable
- l. Power Adapter
- m. Non-slip Pad
- n. Bottom Cover
- o. Bottom Cover Handle

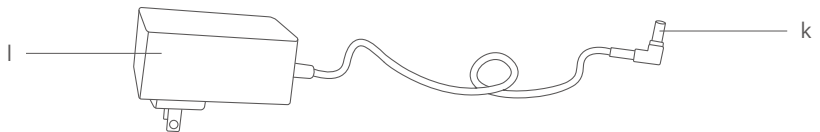
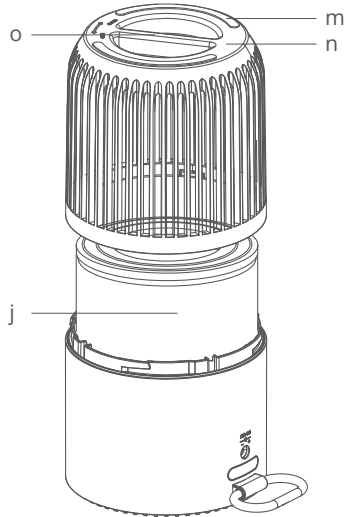
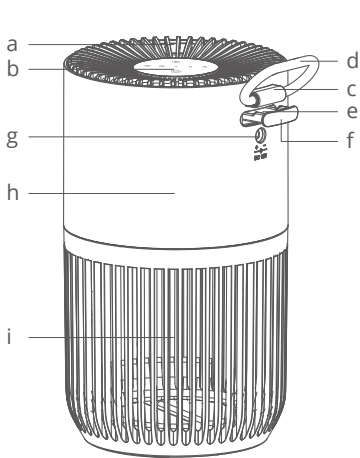

## Control

You can access additional features using Govee Home App.



### 1. Controls & Functions



#### On/Off Button/Control Button

Touch to cycle through the following modes or functions: Sleep Mode, Low Speed, High Speed, Custom Mode/Auto Mode (needs to connect with the Smart Air Quality Monitor, which is sold separately), and Power off.

When Sleep Mode is on, the air purifier will work at its lowest noise setting.

#### Memory Function

The air purifier will save its previous settings when powered off (such as speed, mode, and Wi-Fi connection). When it is powered back on, the settings will resume.

## Indicator Status

Indicator	Working Status	Light Status
	Sleep Mode is On	Solid White
	Low Speed	Solid White
	High Speed	Solid White
	Custom Mode/Auto Mode	Solid White
	Filter is Expired	Solid Red
	Filter Reset Successfully	Triple Flashes
	Ready for Wi-Fi Connection	Slowly Flashes White
	Wi-Fi is Connecting	Quickly Flashes White
	Wi-Fi is Connected	Solid White

# Getting Started

## Using the Smart Mini Air Purifier

1. Hold the handle of the bottom cover and rotate counterclockwise to take the filter out.

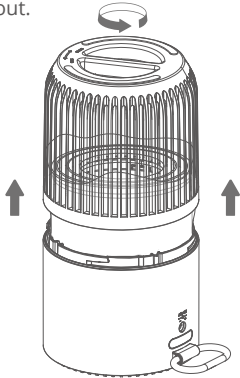

2. Remove the filter from its plastic packaging and place it back into the air purifier.

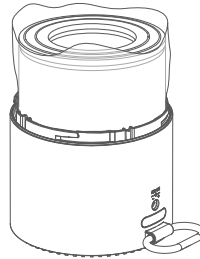

3. Reattach the cover and rotate clockwise to lock. You'll hear a sound to indicate the cover is tightened.

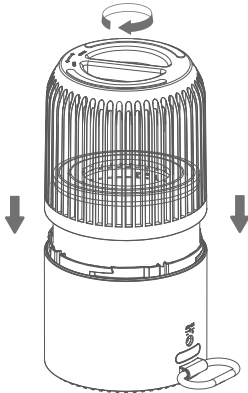

4. Place the air purifier on a flat, stable surface with the panel facing up. Allow at least 8in/20cm of clearance on all sides of the air purifier. Keep away from anything that would block airflow, such as curtains and cabinets.

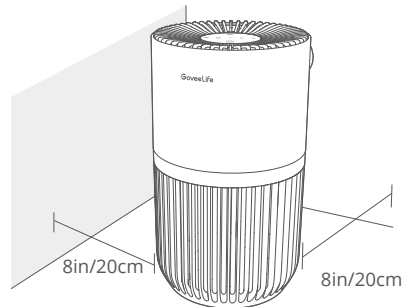

5. Insert the adapter output cable into the DC input port, then plug the power adapter into a 120V socket. Now your purifier is ready to use!



Note : Do not hold on to the handle while loosening the base .

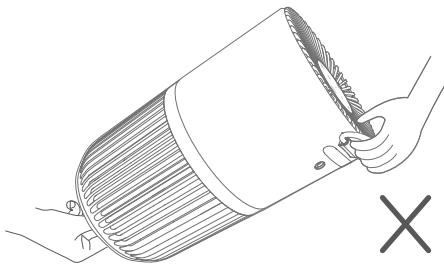

## Using the Aroma Box

1. Press to pop out the aroma box from the back of the base.

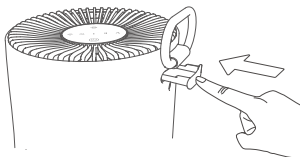

2. Add 8 to 10 drops of essential oil on the aroma pad. Be careful not to spill essential oil out of the aroma box to avoid contaminating the inside of the product.

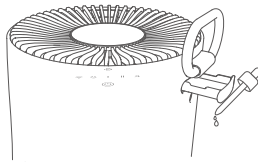

3. Push the aroma box back into the air purifier.

4. Turn on the air purifier. The air purifier will automatically diffuse the aroma when using.

**Note:** To get better aromatherapy, always clean the aroma pad before adding new essential oils. Do not mix essential oils.

## Govee Home App

You can access more features using Govee Home App.

## Downloading Govee Home App

To download Govee Home App, scan the QR code or search for "Govee" in the Apple App Store® (iOS) or Google Play Store (Android).



Govee Home App



**Note:**

- Choose "Allow" to the permissions requested when opening Govee Home App for the first time. These permissions allow the app's features to function normally and are not used to record personal, private information.
- Due to ongoing updates, Govee Home App may be slightly different than shown in this manual. In case of any differences, always follow the in-app instructions.

## Pairing with Govee Home App

1. Turn on your smartphone's Bluetooth.
2. Open Govee Home App, tap the "+" icon in the top right corner and search for "H7126".
3. Tap the device icon and follow the in-app instructions to complete the Bluetooth and Wi-Fi connection.

**Note:**

- Method to turn off Bluetooth and Wi-Fi connection: Press and hold the Power Button for 10s to restore the device to factory settings, then go to "My Devices" page on the app to delete this air purifier first, otherwise it cannot be added to the app again.
- You can use Govee Home App to connect your air purifier to Amazon Alexa or Google Assistant. Click the icon on right upper corner of the details page of the device to follow the in-app instructions to connect to each voice assistant.
- Govee Home App is being continually updated and its features do expand.

## Using the Filters

### 3-Stage Filtration System

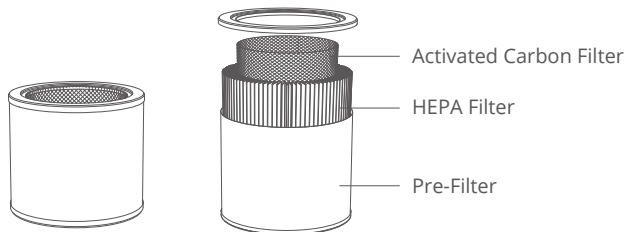

## A. Pre-Filter

- Captures large particles such as dust, lint, fibers, hair, and pet fur.
- Maximizes the filter's life by protecting it from large debris.

## B. HEPA Filter

- Captures 0.3 microns ( $\mu\text{m}$ ) airborne particles.
- Filters small particles such as fine dust, smoke particles, pollen, and pet dander.

## C. Activated Carbon Filter

- Physically adsorbs smoke, odors, and fumes.
- Filters compounds such as formaldehyde, benzene, ammonia, hydrogen sulfide, and volatile organic compounds (VOCs).

## Essential Oils

- Only add essential oils to the aroma pad located in the aroma box near the top of the air purifier.
- Do not add essential oils to the air purifier or filter. The filter will become damaged by the oil and will eventually release an unpleasant smell.

**Note:** Essential oils are not included.

## Clean Air Delivery Rate

- Clean Air Delivery Rate (CADR) measures the efficiency of an air purifier by indicating the volume of clean air that it produces per minute, which is based on the removal of three most common indoor air pollutants including dust, pollen, and smoke. The higher the CADR, the more particles the air purifier will remove and the larger the area it can clean.

- This air purifier has a Clean Air Delivery Rate of 50 cubic feet per minute (CFM), or 85  $\text{m}^3/\text{h}$ , which is measured at the air purifier's highest speed.

**Note:** To effectively clean the air, keep windows and doors closed when the air purifier is on.

## Standard Environment Precautions

### Humidity

Moisture may damage the filters. This air purifier should be used in an area with a humidity level below 85% RH. If you use the air purifier in excessively humid areas, the surface of the filter will become moldy.

# Care & Maintenance

**Caution:** Do not clean with abrasive chemicals or flammable cleaning agents.

## Cleaning the Air Purifier

1. Unplug the purifier from power before cleaning.
2. Wipe the outside of the air purifier with a soft, dry cloth. If necessary, wipe the housing with a damp cloth and leave it to dry.
3. Vacuum the inside of the air purifier.

## Cleaning the Pre-Filter

Do not clean the filter with water or other liquids. The outer pre-filter should be cleaned every 2-4 weeks to increase its efficiency and extend its lifespan. The pre-filter should be cleaned by a soft brush or vacuum hose to remove hair, dust, and large particles.

Filter	When to Clean	When to Replace
Pre-Filter	Vacuum Every 2-4 Weeks	6-8 Months
True HEPA & High-Efficiency Activated Carbon Filter	Do Not Clean	

**Note:** A 3-stage filter includes a Nylon Pre-Filter, HEPA Filter, and Carbon Filter. The three parts of the filter should be replaced as a single unit.

## Replacing the Filter

1. Unplug the air purifier.
2. Remove the old filter.
3. Clean out any remaining dust or hair inside the air purifier using a vacuum hose. Do not use water or liquids to clean the air purifier.
4. Unwrap the new filter and place it into the housing.
5. Reattach the cover. Plug in the air purifier.
6. Reset the Filter Change Indicator.

**Note:**

- To ensure the best performance of your air purifier, only use official GoveeLife filters. To buy replacement filters, visit Govee's online store.
- Remember to reset the Filter Change Indicator after changing the filter.

## Filter Change Time Period

The filter should be replaced every 6–8 months, depending on how often you use it. If you always use your purifier in a relatively high pollution environment, you may need to change the filter more frequently, even if the change indicator does not light up.



Any of the following situations may indicate that you need to change your filter:

- Increased noise when the air purifier is on
- Decreased airflow
- Unusual odors
- A visibly clogged filter

## Resetting the Filter Change Indicator

When the Filter Change Indicator lights red, it indicates that the filter life needs to be reset.

Long press   for 3s.  will flash 3 times and then die out once the filter life is successfully reset.

-  will light up as a reminder to replace the filter. The indicator will light up when you use the purifier for 6 to 8 months. When  turns on, you may not need to replace your filter immediately, but you should check the filter and plan to replace it soon.
- After you replace the filter, remember to reset the Filter Change Indicator.

## Cleaning the Aroma Pad

1. Press to pop out the aroma box and take it out.
2. Take the aroma pad and wash it with warm water.
3. Clean it with a clean cloth and put it back into the aroma box.
4. Push the aroma box back into the air purifier.

**Note:** Do not pour liquid cleaners or detergents onto the aroma pad or into the aroma box.

## Replacing the Aroma Pad

The aroma pad might need to be changed if it is deformed or damaged after repetitive washing.

- If you are refilling the same fragrance oil onto the pad then you probably will have to change pads during a 90 – 120 day period.
- To ensure better effects of the aromatherapy, only use official GoveeLife aroma pads.

## Storing







If not using the air purifier for an extended period of time, wrap both the air purifier and the filter in plastic packaging and store in a dry place to avoid moisture damage.

# Troubleshooting

The troubleshooting section below is for solving frequently asked questions for the purifier unit. If your problem persists, please contact Customer Support.

## For Air Purifier

Problem	Possible Solution
Air purifier cannot turn on or respond to button controls.	Plug in the air purifier.
	Check whether the power cord is damaged. If so, stop using the air purifier and contact Customer Support.
	Plug the air purifier into a different outlet.
	The air purifier may be malfunctioning. Contact Customer Support.
Airflow is significantly reduced.	Make sure the filter is removed from its packaging and properly in place.
	Tap  to increase the fan speed.
	Make sure there are at least 8in/20cm of clearance on all sides of the air purifier.
	The pre-filter may be clogged by large particles such as hair or lint, blocking the air flow. Clean the pre-filter.
	Replace with a new filter.
Air purifier makes an unusual noise while the fan is on.	Make sure the filter is properly in place with plastic packaging removed.
	Make sure the air purifier is operating on a hard, flat, level surface. Replace the filter.
	The air purifier may be damaged, or a foreign object may be inside. Stop using the air purifier and contact Customer Support. Do not try to repair the air purifier.
A strange smell is coming from the air purifier or it has poor odor removal ability.	Clean the filter and aroma pad or replace if necessary.
	Make sure not to use your air purifier in an area with high humidity.
	Remove the filter and expose it to the sun until the smell can be reduced from the activated carbon filter.

Poor air purification quality.	Tap  to increase the fan speed.
	Make sure no objects are blocking the sides or the top of the air purifier (the inlet or outlet).
	Make sure the filter is fully removed from its packaging and is properly secured in place.
	Close doors and windows while using the air purifier.
	If the room is larger than 118ft <sup>2</sup> /11m <sup>2</sup> , air purification will take longer. The air purifier may not be as effective in significantly larger rooms.
	Replace the filter.
Filter Change Indicator is still on after replacing the filter.	Press and hold  for 3s.  will flash 3 times and turn off once successfully reset.
Filter Change Indicator does not light up within 8 months.	 is a reminder for you to check the filter and will light up based on how frequently the air purifier has been used. If you don't use your air purifier often,  will take longer to turn on.
Filter Change Indicator lights up before 6 months.	 is a reminder for you to check the filter and will light up based on how long the air purifier has been used. If you run your air purifier frequently,  will turn on sooner.

## For App & Connectivity

1. Cannot connect to Govee Home App.

- Make sure your smartphone is powered on and is not connected with other Bluetooth devices.
- Enable the smartphone's Location Services.
- Try connecting with another smartphone.
- Make sure your app is updated to the latest version.
- Make sure you connect to your Wi-Fi router's 2.4GHz network and that the network is working correctly.
- Make sure the Wi-Fi password you entered is correct.
- Shorten the distance between the air purifier, Wi-Fi router, and the smartphone. Make sure your air purifier and the Wi-Fi router are located away from appliances that produce electromagnetic radiation (e.g. microwave ovens, refrigerators, etc).
- If you are using a VPN, try turning it off and then connecting the air purifier.
- Disable portal authentication for your Wi-Fi network. If portal authentication is enabled, this air purifier will not be able to access your Wi-Fi network and setup will fail. Portal authentication means that you need to sign in to your Wi-Fi network through a web page before you can use the Internet.

2. Cannot find the device on Bluetooth Device Nearby page of the app.

- The air purifier may be connected with another smartphone. Disconnect it from the other smartphone first.

3. The air purifier is offline.

- Make sure the air purifier is plugged in and powered on, then refresh "My Devices" in Govee Home App by swiping down on the screen.
- Make sure your router is connected to the internet and your phone's network connection is working.
- If the Wi-Fi password has been changed, the air purifier will automatically go offline. Try connecting it to the network again.
- Delete the offline air purifier from Govee Home App, then add and reconfigure the air purifier again in the app.



# Appendix

## After-Sales Service

-  Warranty: 12-Month Limited Warranty
-  Support: Lifetime Technical Support
-  Email: support@govee.com
-  Official Website: www.govee.com
-  @Govee    @goveeofficial    @govee.official
-  @GoveeOfficial    @GoveeOfficial

## Specifications

Power Input (Adapter)	100-240VAC 50/60Hz
Power Input (Air Purifier)	12VDC
Rated Power	8W
Effective Range	110ft <sup>2</sup> /11m <sup>2</sup> <b>Note:</b> <ul style="list-style-type: none"><li>• Effective for larger rooms, but purification will take longer.</li><li>• Determined by CADR.</li></ul>
CADR	50 CFM/85 m <sup>3</sup> /h
Air Purifier Dimensions	6.2*6.2*10.7in/15.8*15.8*27.3cm
Air Purifier Weight	1.13kg
Operating Conditions	Temperature: 32° to 104°F/0° to 40°C
	Humidity: < 85% RH

## Compliance Information

### FCC Statement

This device complies with Part 15 of the FCC Rules. Operation is subject to the following two conditions: (1) this device may not cause harmful interference, and (2) this device must accept any interference received, including interference that may cause undesired operation.

**Warning:** Any Changes or modifications not expressly approved by the party responsible for compliance could void the user's authority to operate the equipment.

**Note:** This equipment has been tested and found to comply with the limits for a Class B digital device, pursuant to Part 15 of the FCC Rules. These limits are designed to provide reasonable protection against harmful interference in a residential installation.

This equipment generates uses and can radiate radio frequency energy and, if not installed and used in accordance with the instructions, may cause harmful interference to radio communications. However, there is no guarantee that interference will not occur in a particular installation. If this equipment does cause harmful interference to radio or television reception, which can be determined by turning the equipment off and on, the user is encouraged to try to correct the interference by one or more of the following measures: (1) Reorient or relocate the receiving antenna. (2) Increase the separation between the equipment and receiver. (3) Connect the equipment into an outlet on a circuit different from that to which the receiver is connected. (4) Consult the dealer or an experienced radio/TV technician for help.

### FCC Radio Frequency Exposure Statement

This equipment complies with FCC radiation exposure limits set forth for an uncontrolled environment. This equipment should be installed and operated with minimum distance 20cm between the radiator & your body.

The following importer is the responsible party  
Name: GOVEE MOMENTS(US) TRADING LIMITED  
Address: 2501 Chatham Rd Suite R Springfield IL 62704  
Email: support@govee.com  
Contact information: <https://www.govee.com/support>

### IC Statement

This device complies with Industry Canada licence-exempt RSS standard(s). Operation is subject to the following two conditions:(1) This device may not cause interference, and(2) this device must accept any interference, including interference that may cause undesired operation of the device.

Le présent appareil est conforme aux CNR d'Industrie Canada applicables aux appareils radio exempts de licence. L'exploitation est autorisée aux deux conditions suivantes:(1) l'appareil n'a pas à produire de brouillage, et(2) l'utilisateur de l'appareil doit accepter tout brouillage radioélectrique subi, même si le brouillage est susceptible d'en compromettre le fonctionnement.

This Class B digital apparatus complies with Canadian ICES-003.  
Cet appareil numérique de la classe B est conforme à la norme NMB-003 du Canada.

## **IC RF Statement**

This equipment complies with IC radiation exposure limits set forth for an uncontrolled environment. This equipment should be installed and operated with minimum distance 20cm between the radiator & your body.

Lors de l'utilisation du produit, maintenez une distance de 20 cm du corps afin de vous conformer aux exigences en matière d'exposition RF.

## **Energy Star**

The energy efficiency of this ENERGY STAR certified model is measured based on a ratio between the model's CADR for Smoke and the electrical energy it consumes, or CADR/Watt.

The Bluetooth® word mark and logos are registered trademarks owned by Bluetooth SIG, Inc. and any use of such marks by Shenzhen Qianyan Technology LTD is under license.

The trademark GoveeLife has been authorised to Shenzhen Qianyan Technology LTD. Copyright ©2021 Shenzhen Qianyan Technology LTD.All Rights Reserved.



Govee Home App

For FAQs and more information,  
please visit: [www.govee.com](http://www.govee.com)