



# User Manual

Model: H70D3

Govee Icicle Lights

## II. Install with zip ties

### Step 1

Use the zip ties to attach and hang the icicle lights from a handrail or fence.

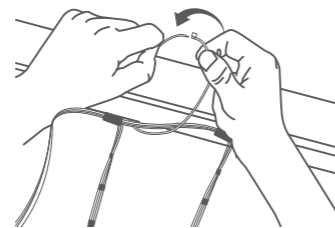

### Tips

Two zip ties can be connected together to make a longer one.

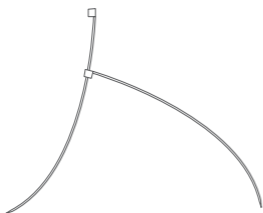

## Specifications

Power Input (Adapter)	100-240VAC 50/60Hz
Power Input (Icicle Light)	24VDC 3A
Length	49.2ft*2
Waterproof Rating	String Light: IP65 Control Box: IP65
Light Displaying Technology	RGBIC

## Troubleshooting

- The light does not work or some part isn't lighting up.
  - Check whether the adapter is working properly.
  - Make sure you have connected the wire connectors between the lights.
  - Long press the control box for more than 5 seconds to reset the whole light.
- Cannot connect to Wi-Fi.
  - Do not skip the Wi-Fi connection steps in the app.
  - Make sure your home Wi-Fi is 2.4Ghz and your smartphone's Bluetooth is on.
  - Long press the control box for more than 5 seconds to reset the whole light. Unpair the light first and then pair it again.
  - Connect your smartphone to Wi-Fi and check whether the network is working.
  - Make sure you have entered the correct Wi-Fi name and password.
  - If the light is too far from the Wi-Fi router, bring the control box close, and then reconnect it to the network.
  - Check if there are too many devices connected to the network. If so, change to another network.
- For other issues
  - For any other issues, please contact the Govee Support Team.

## Customer Service

- Warranty: 12-Month Limited Warranty
- Support: Lifetime Technical Support
- Email: support@govee.com
- Official Website: www.govee.com
- @Govee @govee\_official @govee.official
- @Goveeofficial @Govee.smarthome

## FCC and ISED Canada Statement

This device complies with Part 15 of the FCC Rules and Industry Canada licence-exempt RSS standard(s). Operation is subject to the following two conditions:

- This device may not cause harmful interference, and
- this device must accept any interference received, including interference that may cause undesired operation.

**Warning:** Changes or modifications not expressly approved by the party responsible for compliance could void the user's authority to operate the equipment.

Le présent appareil est conforme aux CNR d'Industrie Canada applicables aux appareils radio exempts de licence. L'exploitation est autorisée aux deux conditions suivantes :

- l'appareil ne doit pas produire de brouillage, et .
- l'utilisateur de l'appareil doit accepter tout brouillage radioélectrique subi, même si le brouillage est susceptible d'en compromettre le fonctionnement.

**NOTE:** This equipment has been tested and found to comply with the limits for a Class B digital device, pursuant to Part 15 of the FCC Rules.

These limits are designed to provide reasonable protection against harmful interference in a residential installation. This equipment generates uses and can radiate radio frequency energy and, if not installed and used in accordance with the instructions, may cause harmful interference to radio communications. However, there is no guarantee that interference will not occur in a particular installation. If this equipment does cause harmful interference to radio or television reception, which can be determined by turning the equipment off and on, the user is encouraged to try to correct the interference by one or more of the following measures:

- Reorient or relocate the receiving antenna.
- Increase the separation between the equipment and receiver.
- Connect the equipment into an outlet on a circuit different from that to which the receiver is connected.
- Consult the dealer or an experienced radio/TV technician for help.

This Class B digital apparatus complies with Canadian ICES-005. Cet appareil numérique de la classe B est conforme à la norme NMB-005 du Canada.

## FCC and IC Radiation Exposure Statement

This equipment complies with FCC and IC radiation exposure limits set forth for an uncontrolled environment. This equipment should be installed and operated with minimum distance 20cm between the radiator & your body.

Lors de l'utilisation du produit, maintenez une distance de 20 cm du corps afin de vous conformer aux exigences en matière d'exposition RF.

### Responsible party (this contact information is only for FCC matters) :

Name: GOVEE MOMENTS(US) TRADING LIMITED  
 Address: 2501 Chatham Rd Suite R Springfield IL 62704  
 Email: certification@govee.com  
 Contact information: <https://www.govee.com/support>

The Bluetooth® word mark and logos are registered trademarks owned by Bluetooth SIG, Inc. and any use of such marks by Shenzhen Qianyan Technology LTD is under license. The trademark Govee have been authorised to Shenzhen Qianyan Technology LTD. Copyright ©2021 Shenzhen Qianyan Technology LTD. All Rights Reserved.



Govee Home App

For FAQs and more information, please visit: [www.govee.com](http://www.govee.com)

## Safety Instructions

### READ AND FOLLOW ALL SAFETY INSTRUCTIONS

- This string light is rated as IP65. It can be used outdoors but cannot be immersed in water.
- The control box is rated as IP65. It can be used outdoors but cannot be immersed in water.
- Tighten all the waterproof wire connection caps before using this product.
- Do not allow children to assemble and install this product.
- Avoid installing this product near major heat sources or other dangerous sources.
- Avoid using other non-standard adapters for this product.
- External dimmers cannot be used with this product.
- Use this product with the provided power adapter only.
- This device uses a non-replaceable light source. When the light source reaches the end of its life cycle, this device should be replaced.
- CAUTION - The product is not a toy. Children and dependents should use it under adult supervision.
- To reduce the risk of strangulation, the flexible cabling making up this icicle light should be effectively fixed to a surface when the cabling is within reach.
- Do not interconnect parts of this lighting chain with parts of another manufacturer's lighting chain.
- Do not connect the chain to the supply while it is in the packaging.

## What You Get

Item	Quantity
Icicle Light	3
Power Adapter	1
User Manual	1
Clips	135
Zip Ties	135

## At a Glance

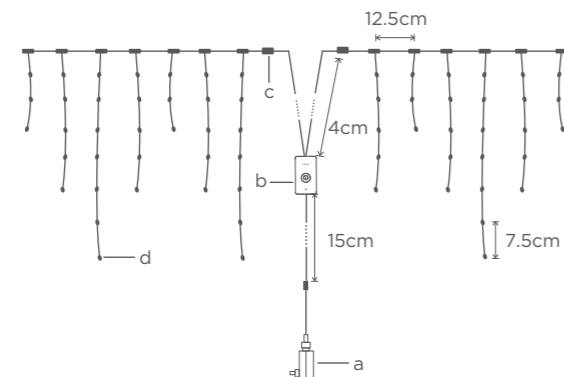

- a. Power Adapter
- b. Control Box
- c. Waterproof Connector
- d. Icicle Light Strings

01

02



Control Box

- Press to turn the lights on or off.
- Press and hold for 5 seconds to reset.

## Disassembly Tip:

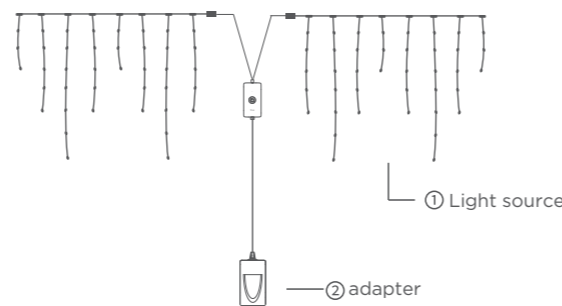

- ① Light source
- ② adapter

The product is divided into two parts: (1) a light source and (2) an adapter. By detaching the output terminal of the adapter, you can easily remove the light source or the adapter.

03

## Pairing Your Light with Govee Home App:

### What You Need

- A Wi-Fi router supporting 2.4GHz and 802.11 b/g/n bands. 5GHz is not supported.
- A smart phone or tablet running iOS8.0 and above or Android4.3 and above.



- 1 Download Govee Home App from the App Store (iOS devices) or Google Play (Android devices).
- 2 Turn on your smartphone's Bluetooth.
- 3 Open the app, tap the "+" icon in the top right corner and search for "H70D3".
- 4 Tap the device icon and follow the on-screen instructions to complete pairing.

## Voice Control:

- 1 Open the app, then tap the "Device" icon to enter the details page.
- 2 Tap the "Settings" icon in the top right corner.
- 3 Select "UserGuide" and follow the on-screen instructions to control the device with your voice.

04

## Installing Your Device:

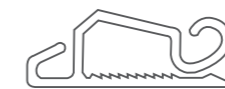

Clips



Zip Ties

Before installation, power on the icicle light and make sure every lamp bead works properly. Find and unwind the thicker main cable, and then unfasten all the icicle light strings.

### I. Install with clips

The recommended distance between clips is 14 inches (35 cm).

Install the clips horizontally under an eave or soffit.

#### Step 1

It is recommended to place the clips along the main cable at every third white-colored icicle light string connector.

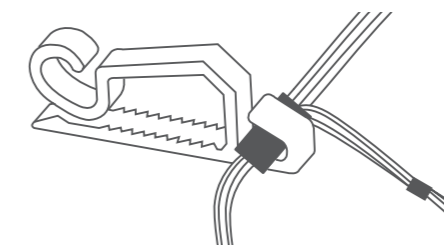

05

#### Step 2

Slide the clips under roof shingles.

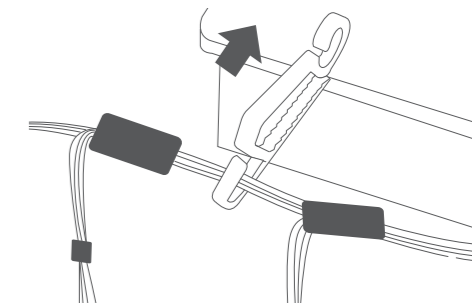

Install the clips vertically onto a gutter.

#### Step 1

Hang the icicle light's main cable from the hook on each clip.

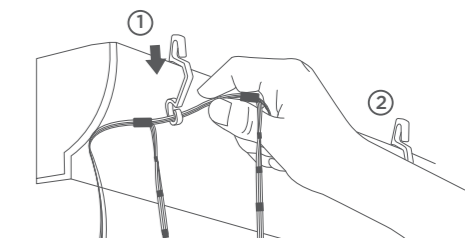

06