

FCC Test Report

Report No.: RWAZ202300086C

Applicant: Shenzhen Qianyan Technology LTD

Address: No.3301, Block C, Section 1, Chuangzhi Yuncheng Building, Liuxian Avenue, Xili Community, Xili Street, Nanshan District, Shenzhen, China

Product Name: Govee Outdoor Ground Lights 2

Product Model: H7053

Multiple Models: H7052

Trade Mark: Govee

FCC ID: 2A7VD-H7053

Standards: FCC CFR Title 47 Part 15C (§15.247)

Test Date: 2023-12-21 to 2023-12-29

Test Result: Complied

Report Date: 2024-01-08

Reviewed by:

Abel chen

Approved by

Jacob Kong

Abel Chen

Project Engineer

Jacob Kong

Manager

Prepared by:

World Alliance Testing and Certification (Shenzhen) Co., Ltd

No. 1002, East Block, Laobing Building, Xingye Road 3012, Xixiang street, Bao'an District, Shenzhen, Guangdong, People's Republic of China



This report may contain data that are not covered by the NVLAP accreditation and shall be marked with an asterisk “★”

Announcement

1. This test report shall not be reproduced in full or partial, without the written approval of World Alliance Testing and Certification (Shenzhen) Co., Ltd
2. The results in this report apply only to the sample tested.
3. This sample tested is in compliance with the limits of the above regulation.
4. This report must not be used by the client to claim product certification, approval, or endorsement by NVLAP, NIST, or any agency of the U.S. Government.
5. The information marked “#” is provided by the applicant, the laboratory is not responsible for its authenticity and this information can affect the validity of the result in the test report. Customer model name, addresses, names, trademarks etc. are included.

Revision History

Version No.	Issued Date	Description
00	2024-01-08	Original

Contents

1	General Information	4
1.1	Client Information	4
1.2	Product Description of EUT	4
1.3	Antenna information	5
1.4	Related Submittal(s)/Grant(s).....	6
1.5	Measurement Uncertainty	6
1.6	Laboratory Location.....	6
1.7	Test Methodology	6
2	Description of Measurement.....	7
2.1	Test Configuration.....	7
2.2	Test Auxiliary Equipment	7
2.3	Test Setup.....	8
2.4	Test Procedure	10
2.5	Measurement Method.....	11
2.6	Measurement Equipment	11
3	Test Results	13
3.1	Test Summary.....	13
3.2	Limit	14
3.3	AC Line Conducted Emissions Test Data.....	15
3.4	Radiated emission Test Data.....	19
3.5	RF Conducted Test Data	27
3.5.1	6 dB Emission Bandwidth and 99% Occupied Bandwidth.....	27
3.5.2	Maximum Conducted Peak Output Power.....	27
3.5.3	Power Spectral Density.....	27
3.5.4	100 kHz Bandwidth of Frequency Band Edge	27
3.5.5	Duty Cycle	28
4	Test Setup Photo.....	35
5	E.U.T Photo.....	36

1 General Information

1.1 Client Information

Applicant:	Shenzhen Qianyan Technology LTD
Address:	No.3301, Block C, Section 1, Chuangzhi Yuncheng Building, Liuxian Avenue, Xili Community, Xili Street, Nanshan District, Shenzhen, China
Manufacturer:	Shenzhen Qianyan Technology LTD
Address:	No.3301, Block C, Section 1, Chuangzhi Yuncheng Building, Liuxian Avenue, Xili Community, Xili Street, Nanshan District, Shenzhen, China

1.2 Product Description of EUT

The EUT is Govee Outdoor Ground Lights 2 that contains 2.4G WLAN and BLE radios, this report covers the full testing of the BLE radio.

Sample Serial Number	1O-3 & 1O-4 for CE test, 1O-1 & 1O-3 & 1O-4 for RE test, 1O-2 for RF test conducted test(assigned by WATC)
Sample Received Date	2023-12-20
Sample Status	Good Condition
Frequency Range	2402-2480MHz
Maximum Conducted Peak Output Power	1.84dBm
Modulation Technology	GFSK
Spatial Streams	3.84dBi
Antenna Gain [#]	SISO (1TX, 1RX)
Power Supply	-20 deg. C~45 deg. C
Operating temperature [#]	H7053: DC 24V/3A from adapter H7052: DC 24V/1.5A from adapter
Adapter Information	For H7053: Model: SOY-2400300US-306 Input: AC100-240V, 50/60Hz, 1.8A Output: DC 24.0V/3.0A For H7052: Model: B136L-240150-AdU Input: AC100-240V, 50/60Hz, 1.2A Output: DC 24.0V/1.5A
Modification	Sample No Modification by the test lab

1.3 Antenna information

15.203 requirement:

An intentional radiator shall be designed to ensure that no antenna other than that furnished by the responsible party shall be used with the device. The use of a permanently attached antenna or of an antenna that uses a unique coupling to the intentional radiator, the manufacturer may design the unit so that a broken antenna can be replaced by the user, but the use of a standard antenna jack or electrical connector is prohibited.

Device Antenna information:

The BLE antenna is an internal antenna which cannot replace by end-user, please see product internal photos for details.

1.4 Related Submittal(s)/Grant(s)

No Related Submittal(s)/Grant(s)

1.5 Measurement Uncertainty

Parameter		Expanded Uncertainty (Confidence of 95%(U = 2Uc(y)))
AC Power Lines Conducted Emissions		±3.14dB
Emissions, Radiated	Below 30MHz	±2.78dB
	Below 1GHz	±4.84dB
	Above 1GHz	±5.44dB
Conducted Power		0.74dB
Frequency Error		150Hz
Bandwidth		0.34%
Power Spectral Density		0.74dB

Note: The extended uncertainty given in this report is obtained by combining the standard uncertainty times the coverage factor K with the 95% confidence interval. Otherwise required by the applicant or Product Regulations, Decision Rule in this report did not consider the uncertainty.

1.6 Laboratory Location

World Alliance Testing and Certification (Shenzhen) Co., Ltd

No. 1002, East Block, Laobing Building, Xingye Road 3012, Xixiang street, Bao'an District, Shenzhen, Guangdong, People's Republic of China

Tel: +86-755-29691511, Email: qa@wadc.com.cn

The lab has been recognized as the FCC accredited lab under the KDB 974614 D01 and is listed in the FCC Public Access Link (PAL) database, FCC Registration No. : 463912, the FCC Designation No. : CN5040.

The lab has been recognized by Innovation, Science and Economic Development Canada to test to Canadian radio equipment requirements, the CAB identifier: CN0160.

1.7 Test Methodology

FCC CFR 47 Part 2

FCC CFR 47 Part 15

KDB 558074 D01 DTS Meas Guidance v05r02

ANSI C63.10-2020

2 Description of Measurement

2.1 Test Configuration

Operating channels:					
Channel No.	Frequency (MHz)	Channel No.	Frequency (MHz)	Channel No.	Frequency (MHz)
0	2402	19	2440	38	2478
1	2404	20	2442	39	2480
...	/	/
18	2438	/	/

According to ANSI C63.10-2020 chapter 5.6.1 Table 11 requirement, select lowest channel, middle channel, and highest channel in the frequency range in which device operates for testing. The detailed frequency points are as follows:

Lowest channel		Middle channel		Highest channel	
Channel No.	Frequency (MHz)	Channel No.	Frequency (MHz)	Channel No.	Frequency (MHz)
0	2402	19	2440	39	2480

Test Mode:					
Transmitting mode:		Keep the EUT in continuous transmitting with modulation			
Exercise software#:		sscom5.13.1			
Mode	Data rate	Power Level Setting [#]			
		Low Channel	Middle Channel	High Channel	
BLE 1M	1Mbps	Of	Of	Of	

The exercise software and the maximum power setting that provided by manufacturer.

Worst-Case Configuration:
For radiated emissions, EUT was investigated in three orthogonal orientation, the worst-case orientation was recorded in report
For AC power line conducted emission and radiated emission 9kHz-1GHz and above 18GHz were performed with the EUT transmits at the channel with highest output power as worst-case scenario.
For model H7053 and H7052, they have same control box(RF circuitry), difference for the lights and adapter, AC power line conducted emission and radiated emission 9kHz-1GHz test both two models, other items was select model H7053 to test.

2.2 Test Auxiliary Equipment

Manufacturer	Description	Model	Serial Number
/	/	/	/

2.3 Test Setup

1) Conducted emission measurement:

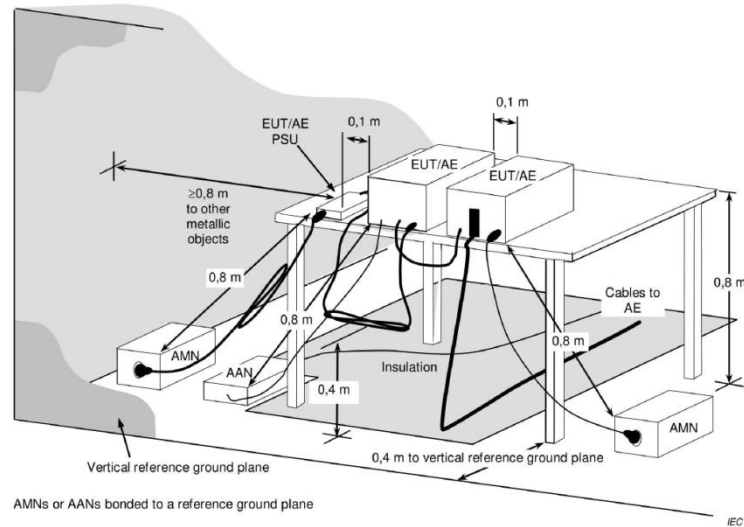

Note: The 0.8 m distance specified between EUT/AE/PSU and AMN/AAN, is applicable only to the EUT being measured. If the device is AE then it shall be >0.8 m.

2) Radiated emission measurement:

Below 30MHz (3m SAC)

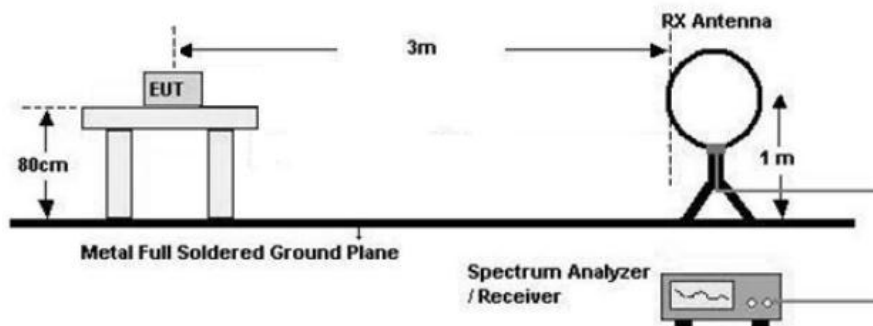

30MHz-1GHz (3m SAC)

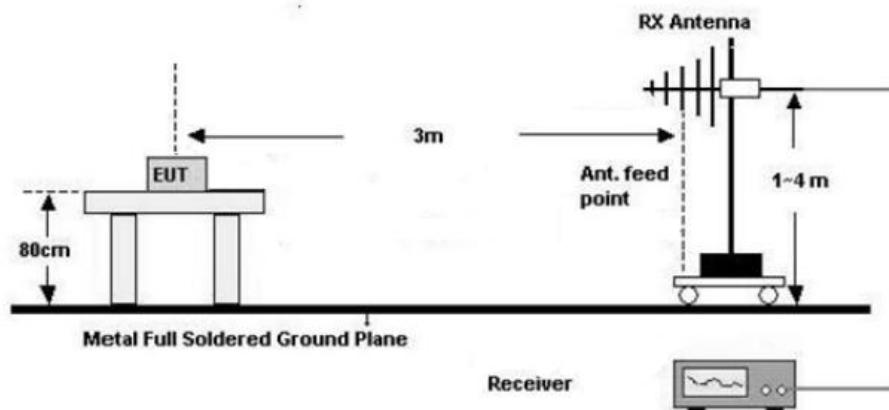

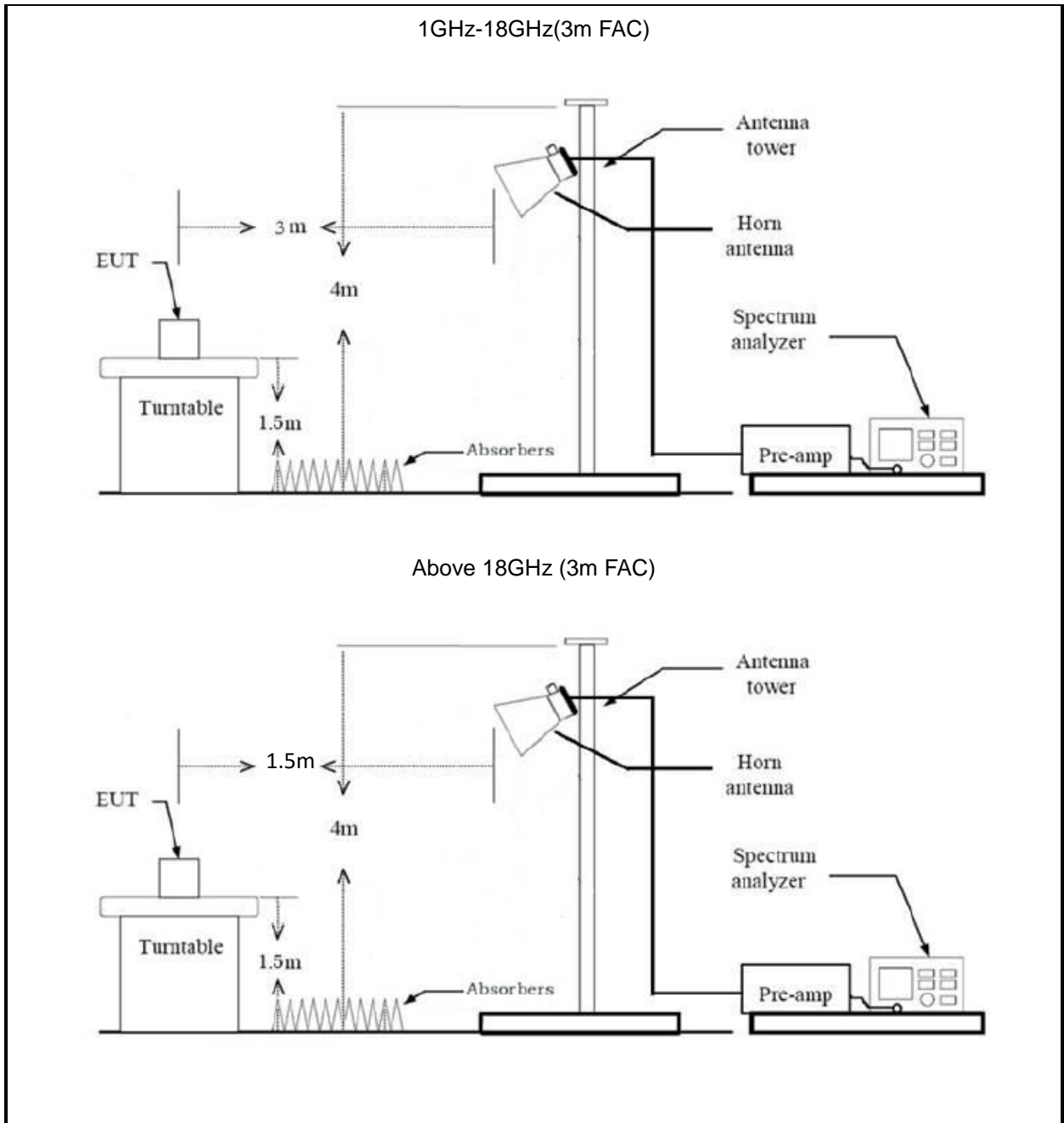

3) RF Conducted Test

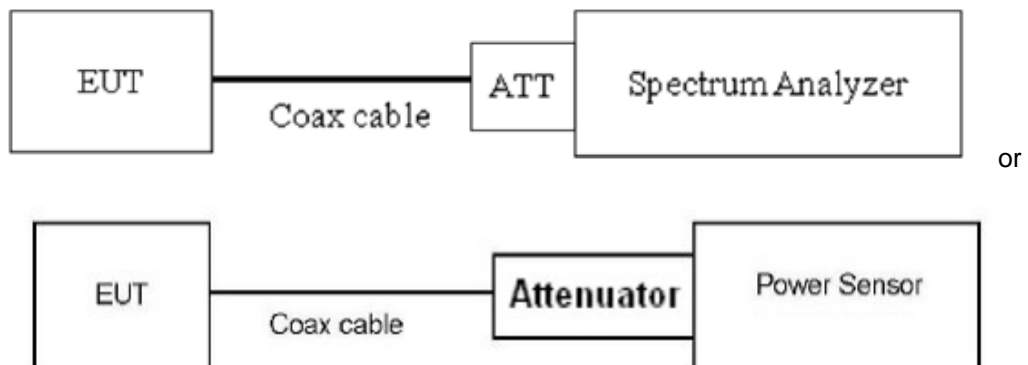

2.4 Test Procedure

Conducted emission:

1. The E.U.T is placed on a non-conducting table 40cm from the vertical ground plane and 80cm above the horizontal ground plane (Please refer to the block diagram of the test setup and photographs).
2. Both sides of A.C. line are checked for maximum conducted interference. In order to find the maximum emission, the relative positions of equipment and all of the interface cables must be changed according to ANSI C63.10 on conducted measurement.
3. Line conducted data is recorded for both Line and Neutral

Radiated Emission Procedure:

a) For below 30MHz

1. All measurements were made at a test distance of 3 m. The measured data was extrapolated from the test distance (3m) to the specification distance (300 m from 9-490 kHz and 30 m from 490 kHz- 30 MHz) to clearly show the relative levels of fundamental and spurious emissions and demonstrate compliance with the requirement that the level of any spurious emissions be below the level of the intentionally transmitted signal. The extrapolation factor for the limits were $40 \cdot \log(\text{test distance} / \text{specification distance})$.
2. Loop antenna use, investigation was done on the three antenna orientations (parallel, perpendicular, ground-parallel)

b) For 30MHz-1GHz:

1. The EUT was placed on the tabletop of a rotating table 0.8 m the ground at a 3 m semi anechoic chamber. The measurement distance from the EUT to the receiving antenna is 3 m.
2. EUT works in each mode of operation that needs to be tested. The highest signal levels relative to the limit shall be determined by rotating the EUT from 0° to 360° and with varying the measurement antenna height between 1 m and 4 m in vertical and horizontal polarizations.

c) For above 1GHz:

1. The EUT was placed on the tabletop of a rotating table 1.5 m the ground at a 3 m fully anechoic room. The measurement distance from the EUT to the receiving antenna is 3 m (1-18GHz) and 1.5 m (above 18GHz).
2. EUT works in each mode of operation that needs to be tested, and having the EUT continuously working. The highest signal levels relative to the limit shall be determined by rotating the EUT from 0° to 360° and with varying the measurement antenna height between 1 m and 4 m in vertical and horizontal polarizations.
3. Open the test software to control the test antenna and test turntable. Perform the test, save the test results, and export the test data.
4. Base on FCC 15.31 (f) (2): measurements may be performed at a distance closer than that specified in the regulations; however, an attempt should be made to avoid making measurements in the near field.

RF Conducted Test:

1. The antenna port of EUT was connected to the RF port of the test equipment (Power Meter or

- Spectrum analyzer) through Attenuator and RF cable.
2. The cable assembly insertion loss of 7.0dB (including 6.0 dB Attenuator and 1.0 dB cable) was entered as an offset in the power meter. Note: Actual cable loss was unavailable at the time of testing, therefore a loss of 1.0dB was assumed as worst case. This was later verified to be true by laboratory. (if the RF cable provided by client, the cable loss declared by client)
 3. The EUT is keeping in continuous transmission mode and tested in all modulation modes.

2.5 Measurement Method

Description of Test	Measurement Method
AC Line Conducted Emissions	ANSI C63.10-2020 Section 6.2
Maximum Conducted Output Power	ANSI C63.10-2020 Section 11.9.1.1
Power Spectral Density	ANSI C63.10-2020 Section 11.10.2
6 dB Emission Bandwidth	ANSI C63.10-2020 Section 11.8.1
99% Occupied Bandwidth	ANSI C63.10-2020 Section 6.9.3
100kHz Bandwidth of Frequency Band Edge	ANSI C63.10-2020 Section 6.10
Radiated emission	ANSI C63.10-2020 Section 11.11&11.12.1
Duty Cycle	ANSI C63.10-2020 Section 11.6

2.6 Measurement Equipment

Manufacturer	Description	Model	Management No.	Calibration Date	Calibration Due Date
AC Line Conducted Emission Test					
ROHDE& SCHWARZ	EMI TEST RECEIVER	ESR	101817	2023/7/3	2024/7/2
R&S	LISN	ENV216	101748	2023/8/1	2024/7/31
N/A	Coaxial Cable	NO.12	N/A	2023/7/3	2024/7/2
Farad	Test Software	EZ-EMC	Ver. EMEC-3A1	/	/
Radiated Emission Test					
R&S	EMI test receiver	ESR3	102758	2023/7/3	2024/7/2
ROHDE& SCHWARZ	SPECTRUM ANALYZER	FSV40-N	101608	2023/7/3	2024/7/2
SONOMA INSTRUMENT	Low frequency amplifier	310	186014	2023/7/12	2024/7/11
COM-POWER	preamplifier	PAM-118A	18040152	2023/8/21	2024/8/20
COM-POWER	Amplifier	PAM-840A	461306	2023/8/8	2024/8/7

ETS	Passive Loop Antenna	6512	29604	2023/7/7	2024/7/6
SCHWARZBECK	Log - periodic wideband antenna	VULB 9163	9163-872	2023/7/7	2024/7/6
Astro Antenna Ltd	Horn antenna	AHA-118S	3015	2023/7/6	2024/7/5
Ducommun technologies	Horn Antenna	ARH-4223-02	1007726-03	2023/7/10	2024/7/9
Oulitong	Band Reject Filter	OBSF-2400-248 3.5-50N	OE02103119	2023/9/15	2024/9/14
N/A	Coaxial Cable	N/A	NO.9	2023/8/8	2024/8/7
N/A	Coaxial Cable	N/A	NO.10	2023/8/8	2024/8/7
N/A	Coaxial Cable	N/A	NO.11	2023/8/8	2024/8/7
Audix	Test Software	E3	191218 V9	/	/
RF Conducted Test					
ROHDE& SCHWARZ	SPECTRUM ANALYZER	FSU-26	200680/026	2023/7/12	2024/7/11
narda	6dB attenuator	603-06-1	N/A	2023/7/26	2024/7/25

Note: All equipment is calibrated with valid calibrations. Each measurement data is traceable to the national or International standards.

3 Test Results

3.1 Test Summary

FCC Rules	Description of Test	Result
§15.203	Antenna Requirement	Compliance
§15.207 (a)	AC Line Conducted Emissions	Compliance
§15.247(b)(3)	Maximum Conducted Output Power	Compliance
§15.247(e)	Power Spectral Density	Compliance
§15.247 (a)(2)	6 dB Emission Bandwidth	Compliance
-	99% Occupied Bandwidth	Report only
§15.247(d)	100kHz Bandwidth of Frequency Band Edge	Compliance
§15.205, §15.209, §15.247(d)	Radiated emission	Compliance
-	Duty Cycle	Report only

3.2 Limit

Test items	Limit
AC Line Conducted Emissions	See details §15.207 (a)
Conducted Output Power	For systems using digital modulation in the 902-928 MHz, 2400-2483.5 MHz, and 5725-5850 MHz bands: 1 Watt.
6dB Emission Bandwidth	The minimum 6 dB bandwidth shall be at least 500 kHz.
Power Spectral Density	For digitally modulated systems, the power spectral density conducted from the intentional radiator to the antenna shall not be greater than 8 dBm in any 3 kHz band during any time interval of continuous transmission.
Spurious Emissions, 100kHz Bandwidth of Frequency Band Edge	In any 100 kHz bandwidth outside the frequency band in which the spread spectrum or digitally modulated intentional radiator is operating, the radio frequency power that is produced by the intentional radiator shall be at least 20 dB below that in the 100 kHz bandwidth within the band that contains the highest level of the desired power, based on either an RF conducted or a radiated measurement, provided the transmitter demonstrates compliance with the peak conducted power limits. If the transmitter complies with the conducted power limits based on the use of RMS averaging over a time interval, as permitted under paragraph (b)(3) of this section, the attenuation required under this paragraph shall be 30 dB instead of 20 dB. Attenuation below the general limits specified in §15.209(a) is not required. In addition, radiated emissions which fall in the restricted bands, as defined in §15.205(a), must also comply with the radiated emission limits specified in §15.209(a) (see §15.205(c)).

3.3 AC Line Conducted Emissions Test Data

Model: H7053

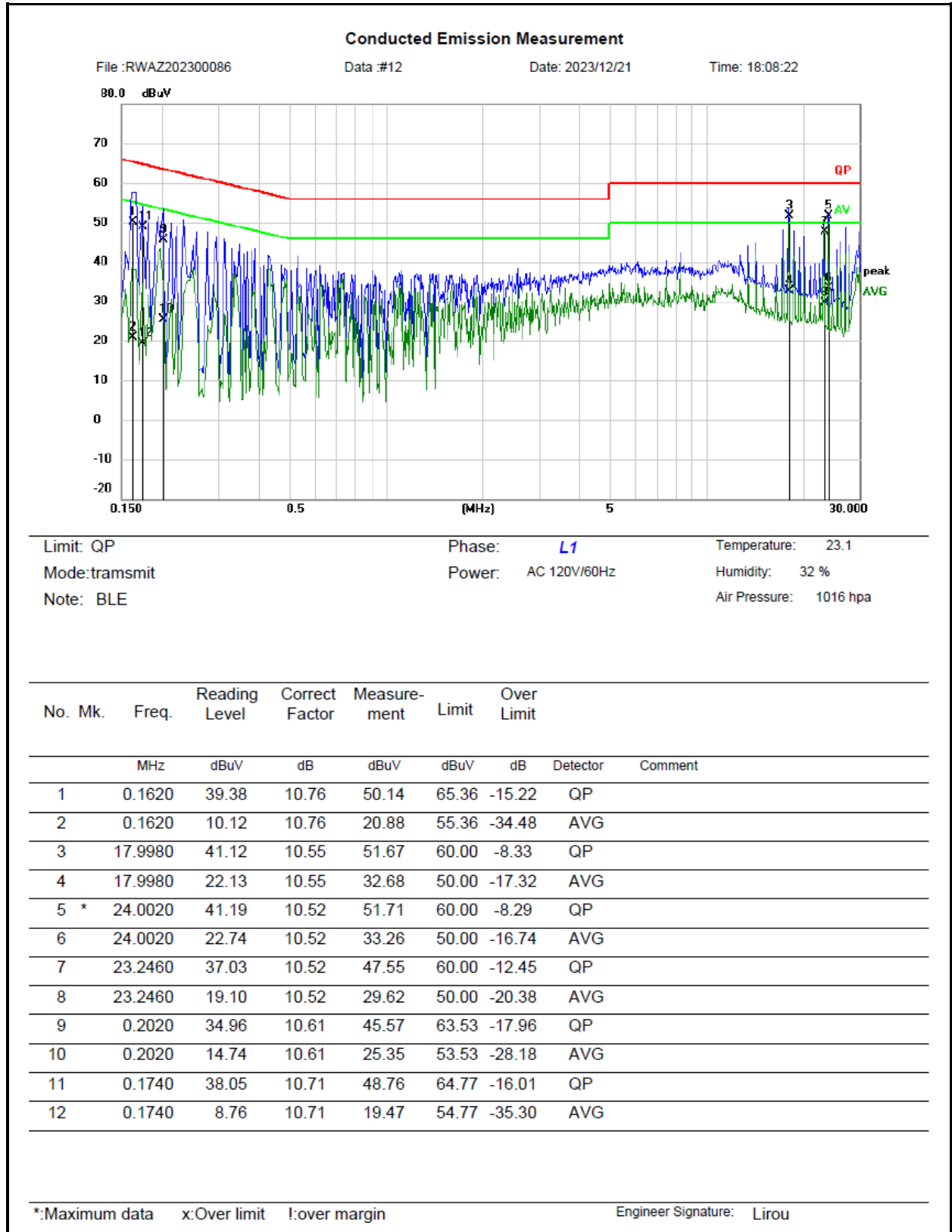

Conducted Emission Measurement

File :RWAZ202300086

Data :#11

Date: 2023/12/21

Time: 18:04:35



Limit: QP
Mode:transmit
Note: BLE

Phase: *N*
Power: AC 120V/60Hz

Temperature: 23.1
Humidity: 32 %
Air Pressure: 1016 hpa

No.	Mk.	Freq.	Reading Level	Correct Factor	Measurement	Limit	Over Limit	Detector	Comment
		MHz	dBuV	dB	dBuV	dBuV	dB		
1		0.2100	35.92	10.42	46.34	63.21	-16.87	QP	
2		0.2100	6.91	10.42	17.33	53.21	-35.88	AVG	
3		0.1700	40.13	10.53	50.66	64.96	-14.30	QP	
4		0.1700	10.05	10.53	20.58	54.96	-34.38	AVG	
5	*	23.9980	40.88	10.74	51.62	60.00	-8.38	QP	
6		23.9980	21.76	10.74	32.50	50.00	-17.50	AVG	
7		20.2500	39.64	10.65	50.29	60.00	-9.71	QP	
8		20.2500	22.03	10.65	32.68	50.00	-17.32	AVG	
9		27.7540	37.53	10.76	48.29	60.00	-11.71	QP	
10		27.7540	19.23	10.76	29.99	50.00	-20.01	AVG	
11		20.9980	38.01	10.65	48.66	60.00	-11.34	QP	
12		20.9980	17.55	10.65	28.20	50.00	-21.80	AVG	
13		0.2420	34.12	10.46	44.58	62.03	-17.45	QP	
14		0.2420	24.43	10.46	34.89	52.03	-17.14	AVG	

*:Maximum data x:Over limit !:over margin

Engineer Signature: Lirou

Model: H7052

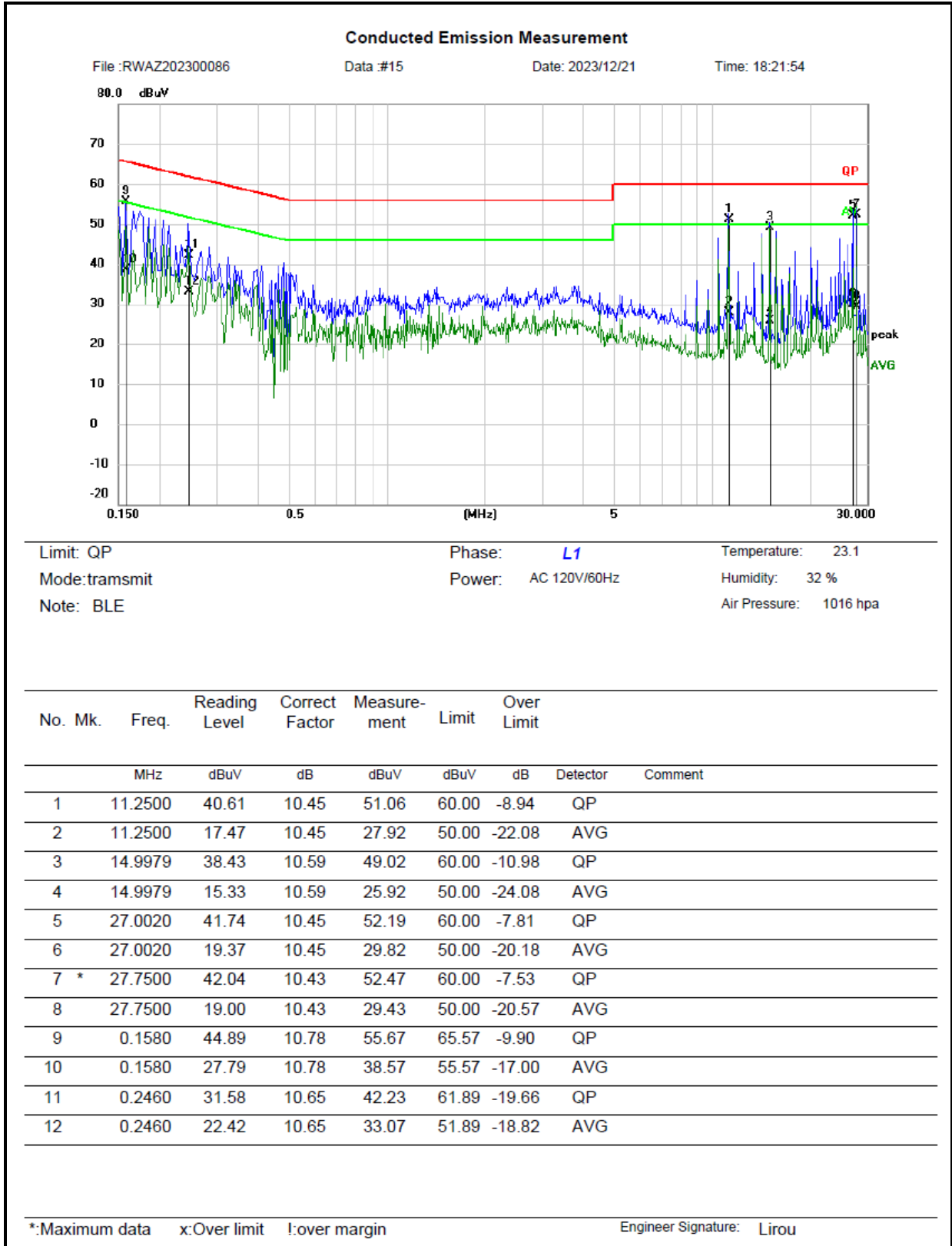

Conducted Emission Measurement

File :RWAZ202300086

Data :#16

Date: 2023/12/21

Time: 18:24:15

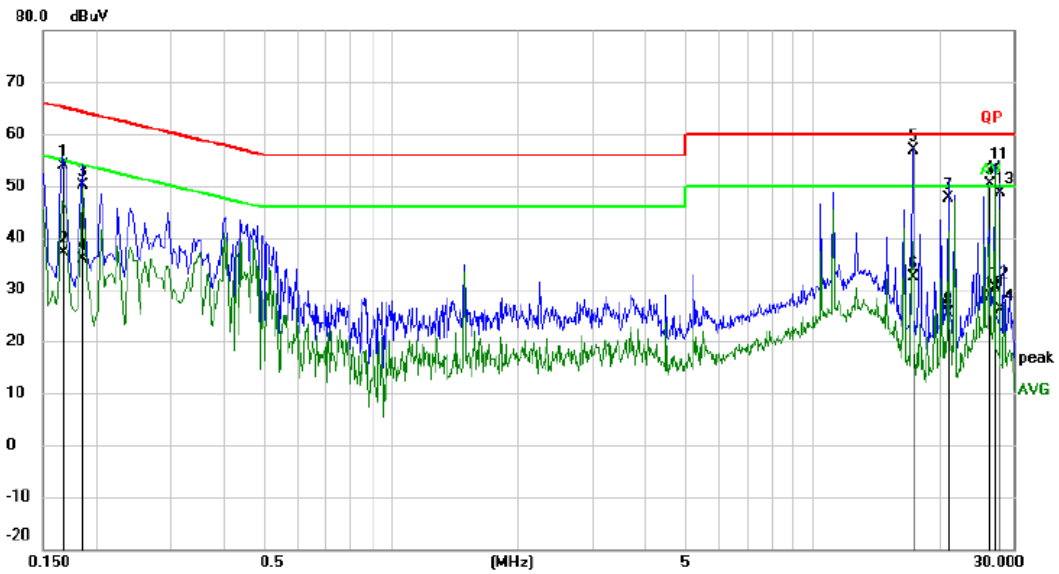

Limit: QP
Mode:transmit
Note: BLE

Phase: **N**
Power: AC 120V/60Hz

Temperature: 23.1
Humidity: 32 %
Air Pressure: 1016 hpa

No. Mk.	Freq.	Reading Level	Correct Factor	Measurement	Limit	Over Limit	Detector	Comment
	MHz	dBuV	dB	dBuV	dBuV	dB		
1	0.1660	43.43	10.55	53.98	65.16	-11.18	QP	
2	0.1660	26.59	10.55	37.14	55.16	-18.02	AVG	
3	0.1860	39.58	10.47	50.05	64.21	-14.16	QP	
4	0.1860	25.47	10.47	35.94	54.21	-18.27	AVG	
5 *	17.2500	46.22	10.77	56.99	60.00	-3.01	QP	
6	17.2500	21.52	10.77	32.29	50.00	-17.71	AVG	
7	20.9940	36.87	10.65	47.52	60.00	-12.48	QP	
8	20.9940	14.84	10.65	25.49	50.00	-24.51	AVG	
9	26.2500	39.58	10.73	50.31	60.00	-9.69	QP	
10	26.2500	17.92	10.73	28.65	50.00	-21.35	AVG	
11	27.0020	42.59	10.76	53.35	60.00	-6.65	QP	
12	27.0020	19.54	10.76	30.30	50.00	-19.70	AVG	
13	27.7540	37.89	10.76	48.65	60.00	-11.35	QP	
14	27.7540	15.26	10.76	26.02	50.00	-23.98	AVG	

*:Maximum data x:Over limit !:over margin

Engineer Signature: Lirou

Remark:

Measurement (dBuV)= Reading Level (dBuV) + Correct Factor(dB)

Correct Factor (dB)= LISN Voltage Division Factor (dB)+ Cable loss(dB)

Over Limit= Measurement – Limit

3.4 Radiated emission Test Data

9 kHz-30MHz:

Test Date:	2023-12-29	Test By:	Luke Li
Environment condition:	Temperature: 23.8°C; Relative Humidity:48%; ATM Pressure: 101.5kPa		

For radiated emissions below 30MHz, there were no emissions found within 20dB of limit.

30MHz-1GHz:

Test Date:	2023-12-29	Test By:	Luke Li
Environment condition:	Temperature: 23.8°C; Relative Humidity:48%; ATM Pressure: 101.5kPa		

Model: H7053

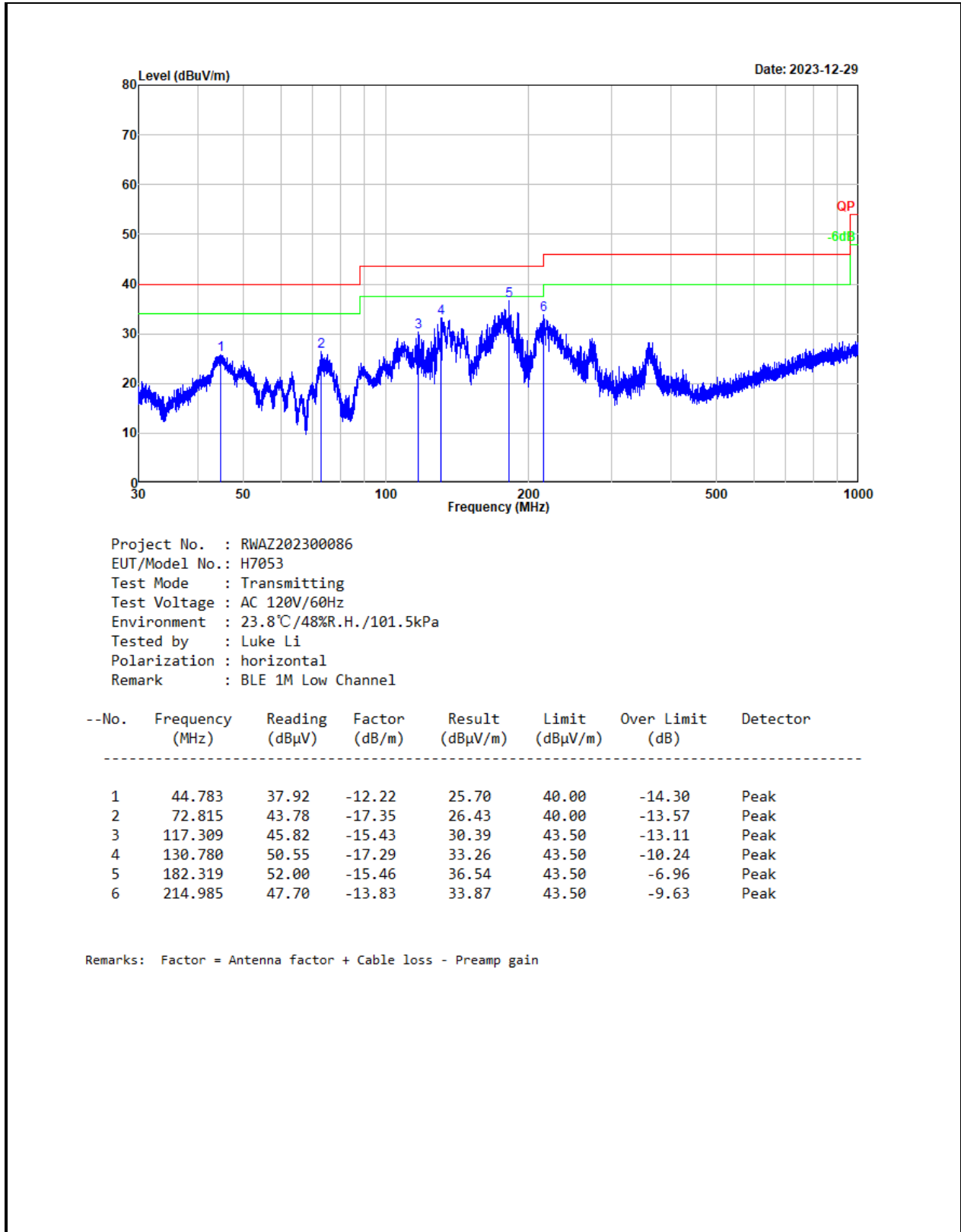

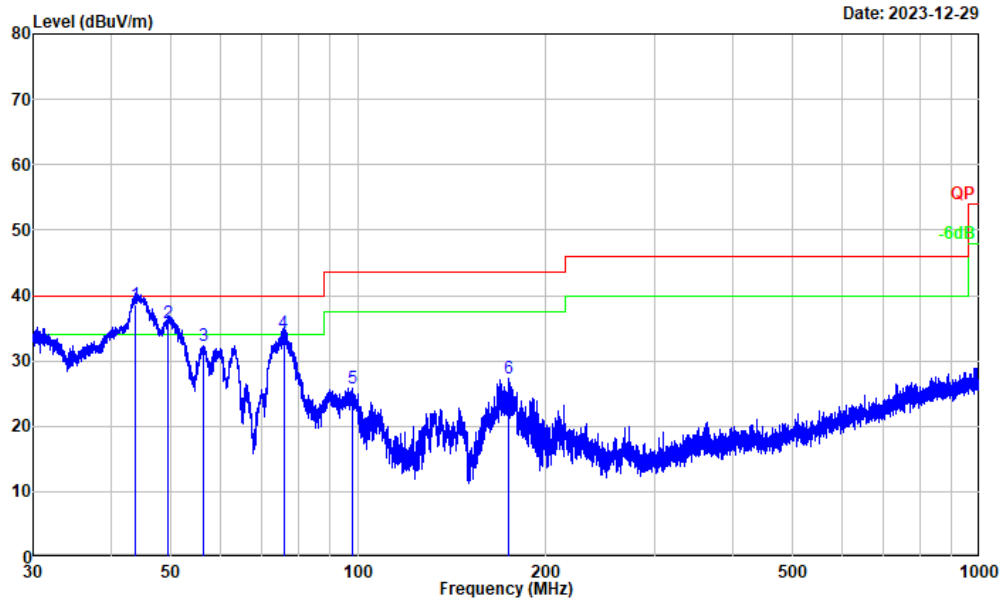

Project No. : RWAZ202300086
 EUT/Model No.: H7053
 Test Mode : Transmitting
 Test Voltage : AC 120V/60Hz
 Environment : 23.8°C/48%R.H./101.5kPa
 Tested by : Luke Li
 Polarization : vertical
 Remark : BLE 1M Low Channel

--No.	Frequency (MHz)	Reading (dBμV)	Factor (dB/m)	Result (dBμV/m)	Limit (dBμV/m)	Over Limit (dB)	Detector
1	43.908	50.86	-12.31	38.55	40.00	-1.45	QP
2	49.381	48.00	-12.16	35.84	40.00	-4.16	QP
3	56.296	45.24	-12.95	32.29	40.00	-7.71	Peak
4	75.878	52.31	-18.09	34.22	40.00	-5.78	QP
5	97.713	40.36	-14.52	25.84	43.50	-17.66	Peak
6	174.807	43.43	-16.05	27.38	43.50	-16.12	Peak

Remarks: Factor = Antenna factor + Cable loss - Preamp gain

Model: H7052

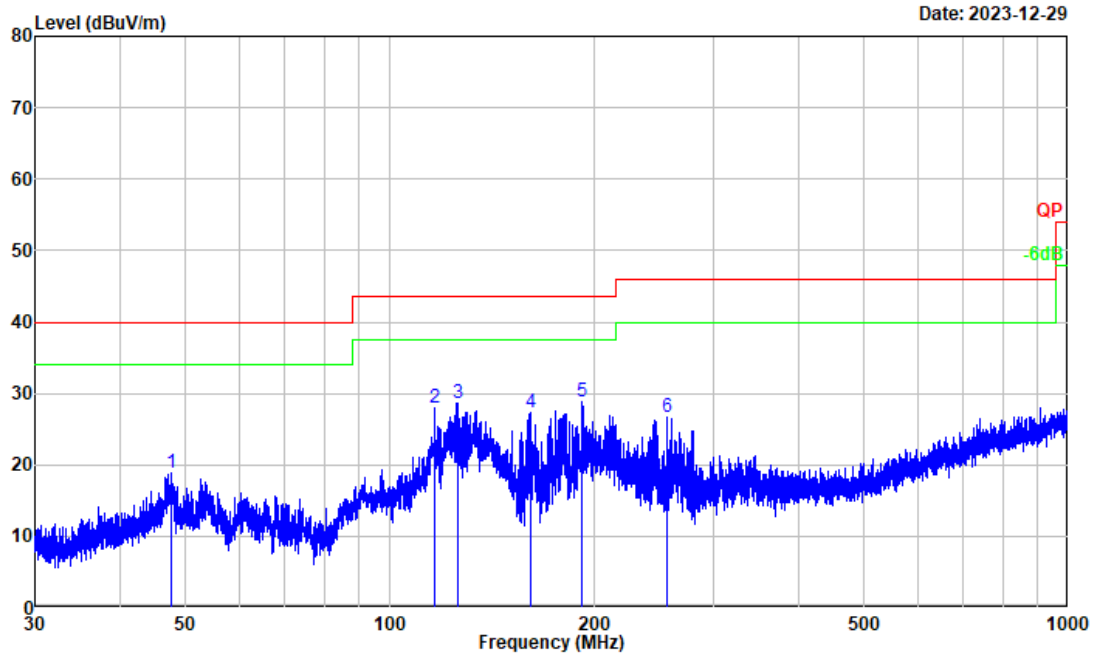

Project No. : RWAZ202300086
 EUT/Model No.: H7052
 Test Mode : Transmitting
 Test Voltage : AC 120V/60Hz
 Environment : 23.8°C/48%R.H./101.5kPa
 Tested by : Luke Li
 Polarization : horizontal
 Remark : BLE 1M Low Channel

--No.	Frequency (MHz)	Reading (dBμV)	Factor (dB/m)	Result (dBμV/m)	Limit (dBμV/m)	Over Limit (dB)	Detector
1	47.596	31.09	-12.18	18.91	40.00	-21.09	Peak
2	116.438	43.28	-15.26	28.02	43.50	-15.48	Peak
3	126.273	45.60	-16.94	28.66	43.50	-14.84	Peak
4	160.980	44.03	-16.79	27.24	43.50	-16.26	Peak
5	192.250	43.35	-14.42	28.93	43.50	-14.57	Peak
6	256.184	39.07	-12.31	26.76	46.00	-19.24	Peak

Remarks: Factor = Antenna factor + Cable loss - Preamp gain

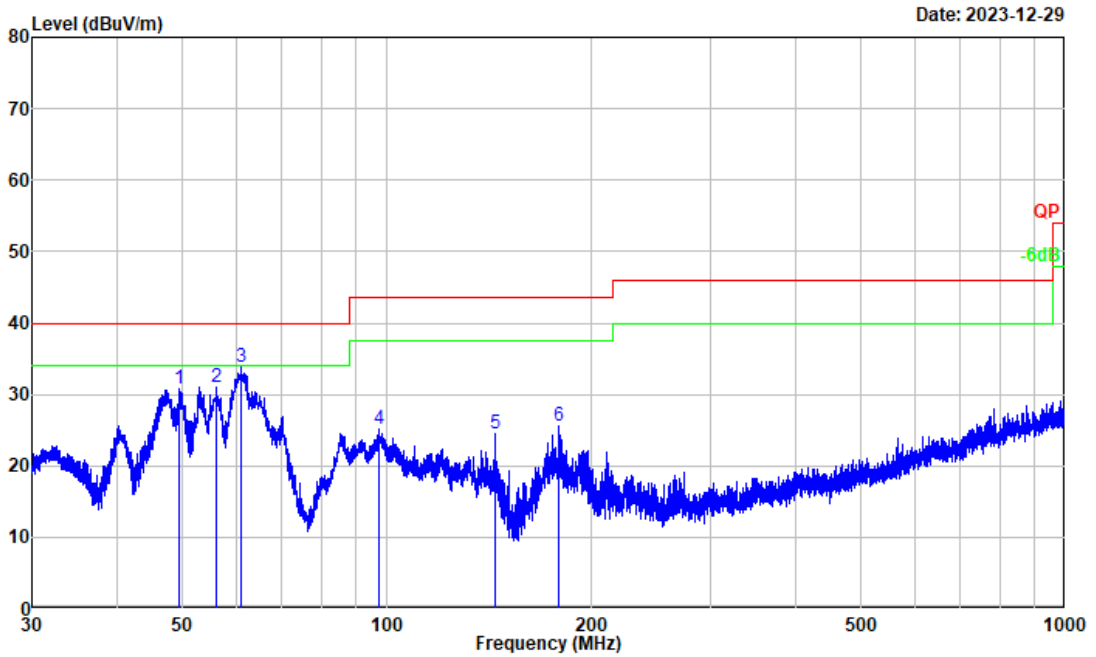

Project No. : RWAZ202300086
 EUT/Model No.: H7052
 Test Mode : Transmitting
 Test Voltage : AC 120V/60Hz
 Environment : 23.8°C/48%R.H./101.5kPa
 Tested by : Luke Li
 Polarization : vertical
 Remark : BLE 1M Low Channel

--No.	Frequency (MHz)	Reading (dBμV)	Factor (dB/m)	Result (dBμV/m)	Limit (dBμV/m)	Over Limit (dB)	Detector
1	49.489	42.85	-12.16	30.69	40.00	-9.31	Peak
2	55.976	43.96	-12.90	31.06	40.00	-8.94	Peak
3	61.051	47.64	-13.85	33.79	40.00	-6.21	Peak
4	97.371	39.65	-14.55	25.10	43.50	-18.40	Peak
5	144.272	42.01	-17.60	24.41	43.50	-19.09	Peak
6	179.622	41.32	-15.71	25.61	43.50	-17.89	Peak

Remarks: Factor = Antenna factor + Cable loss - Preamp gain

Remark:

Level = Reading + Factor

Factor = Antenna factor + Cable loss – Amplifier gain

Over Limit = Level – Limit

Above 1GHz:

Test Date:	2023-12-25	Test By:	Luke Li
Environment condition:	Temperature: 22.2°C; Relative Humidity:28%; ATM Pressure: 101.7kPa		

Frequency (MHz)	Reading level (dBμV)	Polar	Corrected Factor (dB/m)	Corrected Amplitude (dBμV/m)	Limit (dBμV/m)	Margin (dB)	Remark
Low Channel							
2378.339	40.09	horizontal	8.24	48.33	54.00	-5.67	Average
2378.339	51.95	horizontal	8.24	60.19	74.00	-13.81	Peak
2378.197	39.74	vertical	8.24	47.98	54.00	-6.02	Average
2378.197	52.09	vertical	8.24	60.33	74.00	-13.67	Peak
4804.000	51.53	horizontal	0.21	51.74	74.00	-22.26	Peak
4804.000	50.71	vertical	0.21	50.92	74.00	-23.08	Peak
Middle Channel							
4880.000	50.79	horizontal	0.44	51.23	74.00	-22.77	Peak
4880.000	49.53	vertical	0.44	49.97	74.00	-24.03	Peak
High Channel							
2483.500	42.19	horizontal	8.25	50.44	54.00	-3.56	Average
2483.500	54.15	horizontal	8.25	62.40	74.00	-11.60	Peak
2483.500	39.40	vertical	8.25	47.65	54.00	-6.35	Average
2483.500	52.70	vertical	8.25	60.95	74.00	-13.05	Peak
4960.000	49.15	horizontal	0.93	50.08	74.00	-23.92	Peak
4960.000	48.47	vertical	0.93	49.40	74.00	-24.60	Peak

Remark:

Corrected Amplitude= Reading level + corrected Factor

Corrected Factor = Antenna factor + Cable loss – Amplifier gain

Margin = Corrected Amplitude – Limit

For the test result of PK was more than 20dB below the PK limit, which can compliance with the average limit, just the PK level was recorded.

The emission levels of other frequencies that were lower than the limit 20dB not show in test report.

For emissions in 18GHz-25GHz range, all emissions were investigated and in the noise floor level.

Test plot for example as below:

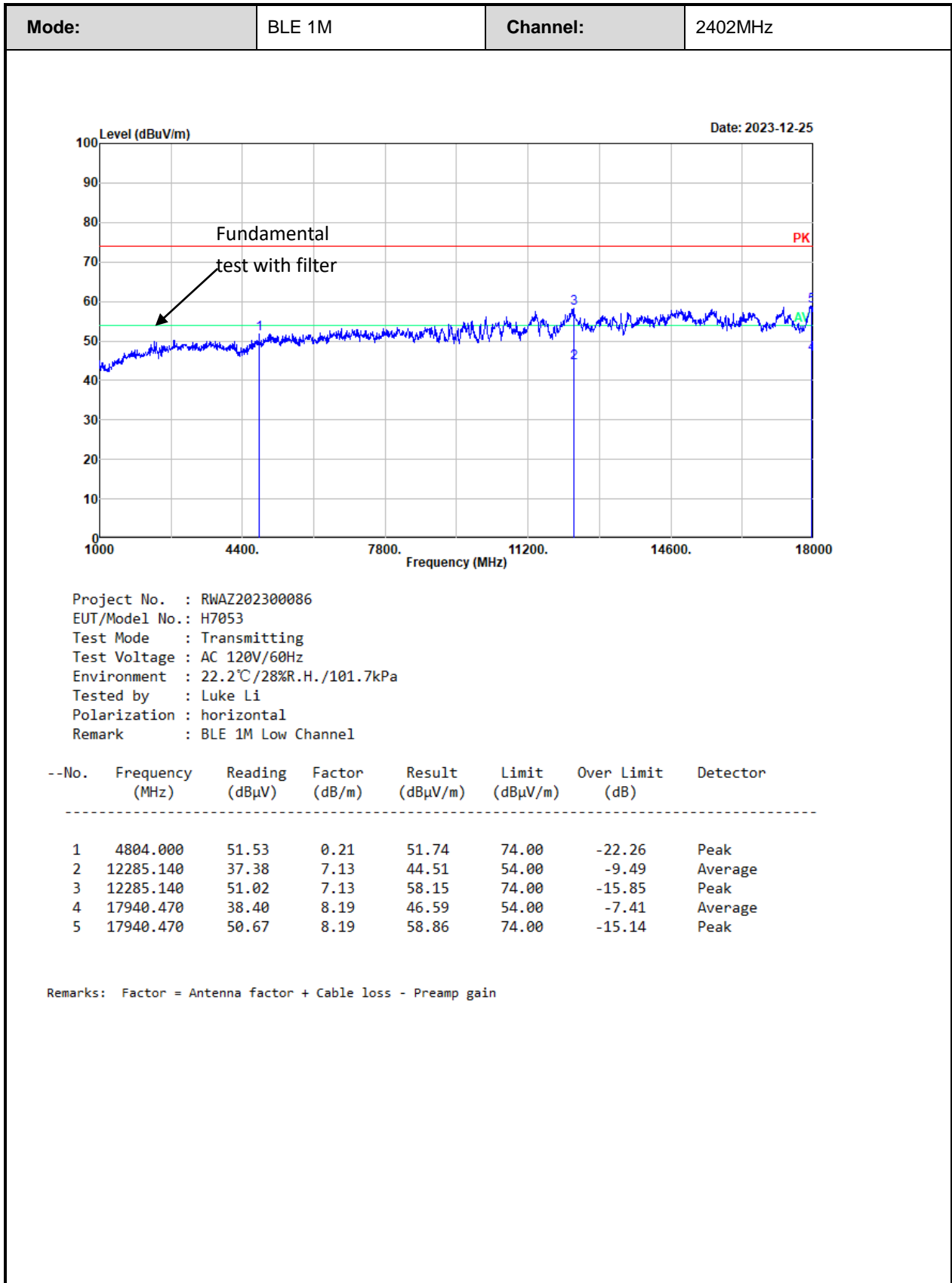

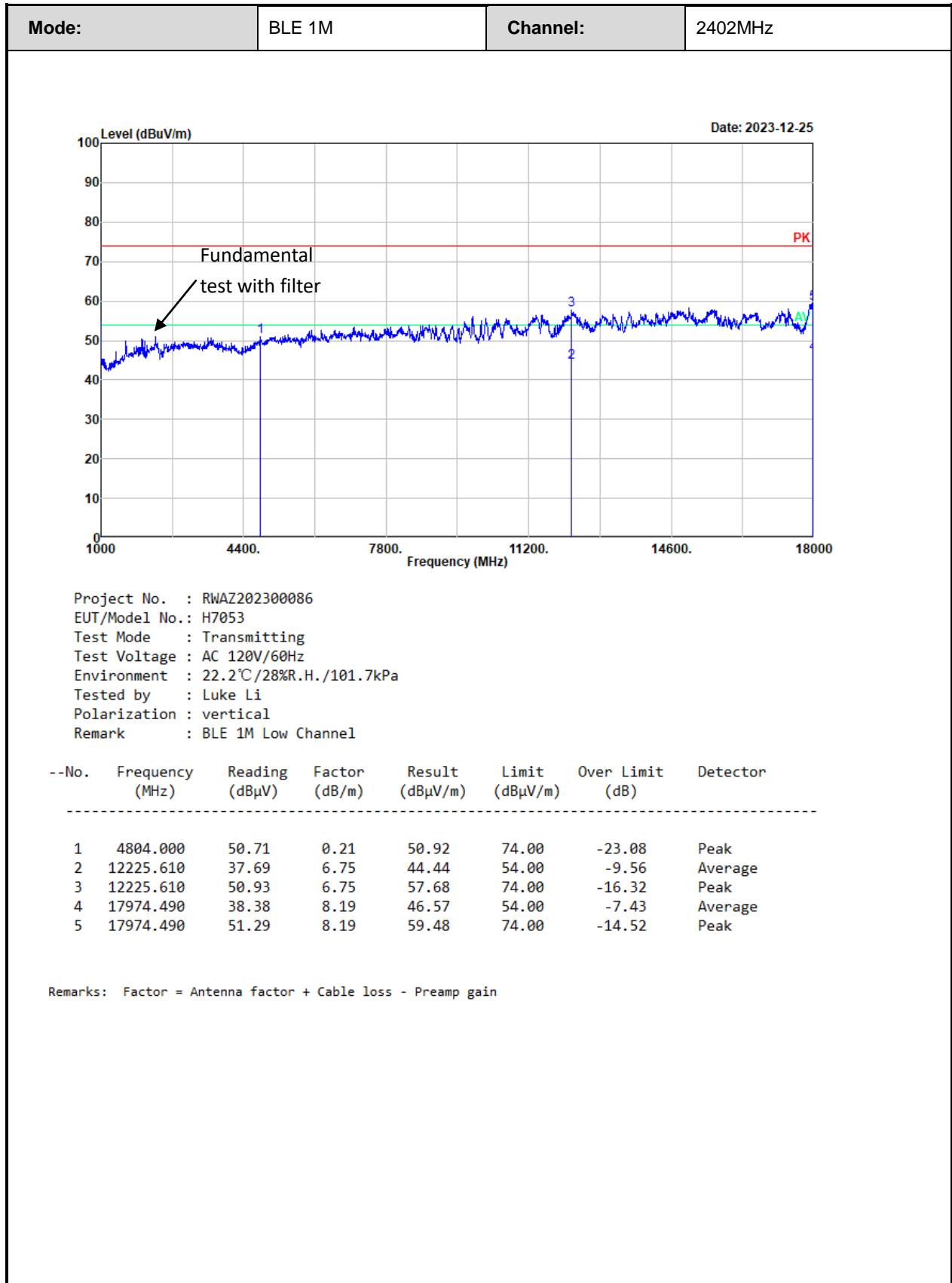

3.5 RF Conducted Test Data

Test Date:	2023-12-27	Test By:	Ryan Zhang
Environment condition:	Temperature: 18°C; Relative Humidity: 41.5%; ATM Pressure: 102.3kPa		

3.5.1 6 dB Emission Bandwidth and 99% Occupied Bandwidth

Test Mode	Channel[MHz]	6dB BW [MHz]	99% OBW[MHz]	6dB BW Limit[MHz]	Verdict
BLE 1M	2402	0.676	1.072	0.5	pass
	2440	0.676	1.076	0.5	pass
	2480	0.672	1.084	0.5	pass

3.5.2 Maximum Conducted Peak Output Power

Test Mode	Channel [MHz]	Result [dBm]	Limit [dBm]	Verdict
BLE 1M	2402	1.84	30	Pass
	2440	1.67	30	Pass
	2480	1.72	30	Pass

3.5.3 Power Spectral Density

Test Mode	Channel [MHz]	Result [dBm/3kHz]	Limit [dBm/3kHz]	Verdict
BLE 1M	2402	-11.79	8	Pass
	2440	-12.00	8	Pass
	2480	-11.94	8	Pass

3.5.4 100 kHz Bandwidth of Frequency Band Edge

Test Mode	Channel	Result	Limit	Verdict
BLE 1M	2402	Refer test plot	Refer test plot	Pass
	2480	Refer test plot	Refer test plot	Pass

3.5.5 Duty Cycle

Test Mode	Channel	Ton (ms)	Ton+off (ms)	Duty Cycle [%]	1/T	VBW setting [Hz]
BLE 1M	2440	100	100	100	/	10

Test Plots:

6 dB Emission Bandwidth:

BLE 1M	/
Lowest channel	/
<p>Date: 27.DEC.2023 10:24:26</p>	/
Middle channel	/
<p>Date: 27.DEC.2023 10:28:44</p>	/
High channel	/
<p>Date: 27.DEC.2023 10:30:03</p>	/

99% Occupied Bandwidth:

BLE 1M	/
Lowest channel	/
<p>Date: 27.DEC.2023 10:24:34</p>	/
Middle channel	/
<p>Date: 27.DEC.2023 10:28:52</p>	/
High channel	/
<p>Date: 27.DEC.2023 10:30:11</p>	/

Maximum Conducted Peak Output Power:

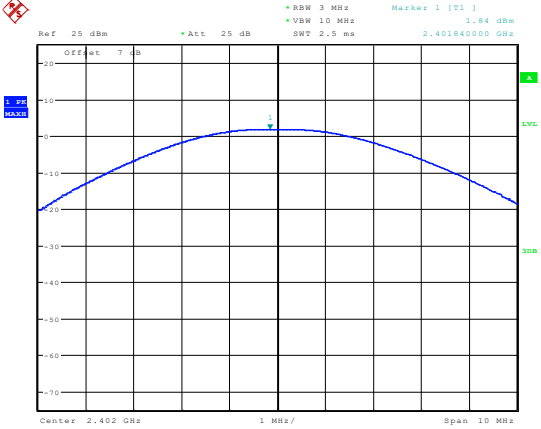
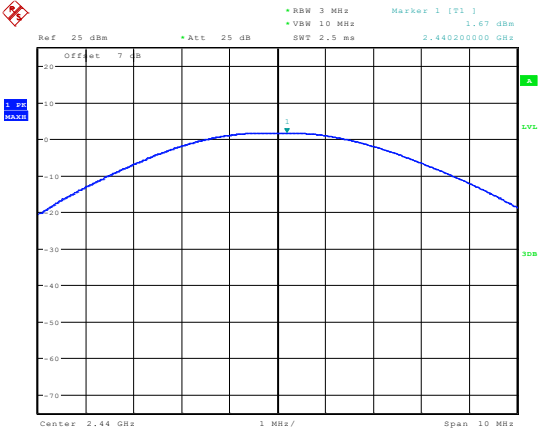
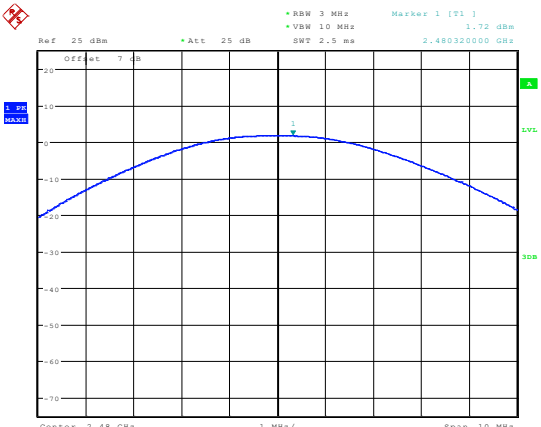
BLE 1M	/
Lowest channel	/
 <p>Date: 27.DEC.2023 10:24:47</p>	/
Middle channel	/
 <p>Date: 27.DEC.2023 10:29:05</p>	/
High channel	/
 <p>Date: 27.DEC.2023 10:30:24</p>	/

Power Spectral Density:

BLE 1M	/
Lowest channel	/
<p>Ref: 25 dBm *Att: 25 dB RBW: 3 kHz VSW: 10 kHz SWT: 115 ms Marker 1 [T1]: -11.79 dBm 2.401920908 GHz</p> <p>Center: 2.402 GHz 101.4 kHz/ Span: 1.014 MHz</p> <p>Date: 27.DEC.2023 10:24:53</p>	/
Middle channel	/
<p>Ref: 25 dBm *Att: 25 dB RBW: 3 kHz VSW: 10 kHz SWT: 115 ms Marker 1 [T1]: -12.00 dBm 2.439620908 GHz</p> <p>Center: 2.44 GHz 101.4 kHz/ Span: 1.014 MHz</p> <p>Date: 27.DEC.2023 10:29:12</p>	/
High channel	/
<p>Ref: 25 dBm *Att: 25 dB RBW: 3 kHz VSW: 10 kHz SWT: 115 ms Marker 1 [T1]: -11.94 dBm 2.479921376 GHz</p> <p>Center: 2.48 GHz 100.8 kHz/ Span: 1.008 MHz</p> <p>Date: 27.DEC.2023 10:30:33</p>	/

100kHz Bandwidth of Frequency Band Edge:

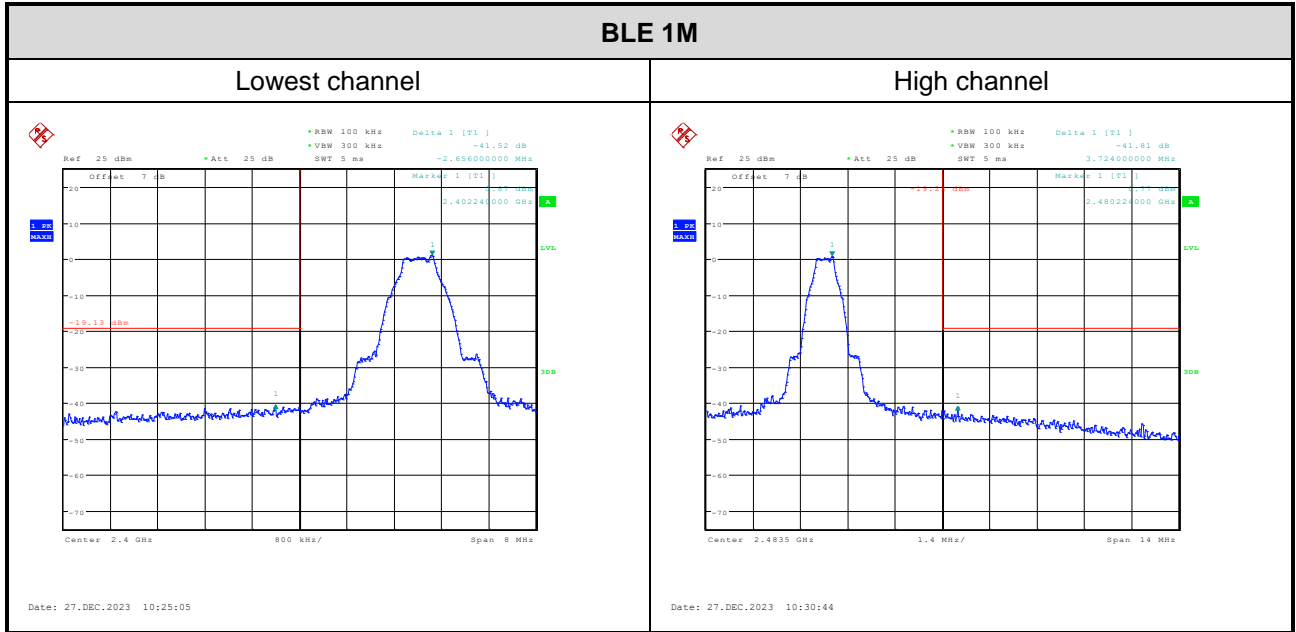

Duty Cycle:

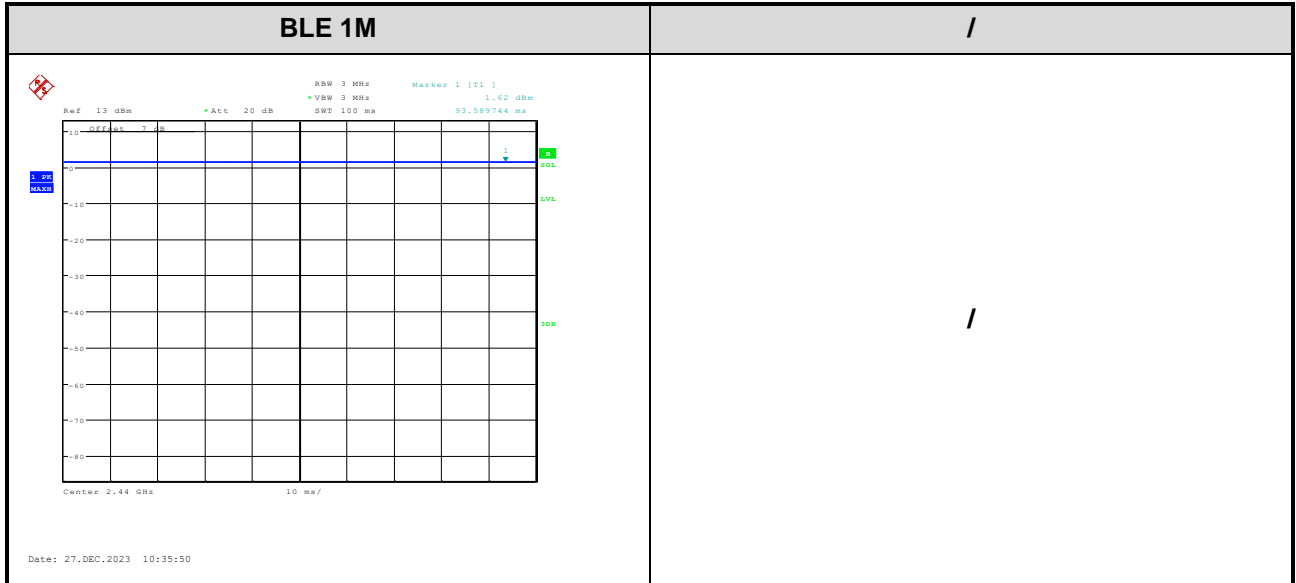

4 Test Setup Photo

Please refer to the attachment RWAZ202300086 Test Setup photo.

5 E.U.T Photo

Please refer to the attachment:

- (1) RWAZ202300086 H7053 External photo;
- (2) RWAZ202300086 H7053 Internal photo;
- (3) RWAZ202300086 H7052 External photo;
- (4) RWAZ202300086 H7052 Internal photo

---End of Report---