

Antenna test report

Test Laboratory	Dongguan Yijia Electronic Co., LTD
Address	No. 59 Muyu Road, Shatou Community, Chang 'an Town, Dongguan City, Guangdong Province
Contact:	Mr. Gan 13823198410
Model	H7039

1. Test procedures

Name	Parameter	Method	Standard No.
Mobile communication antenna	VSWR	Generic specification for antennas used in the mobile communications	GB/T 9410-2008
	Antenna Gain		
	Radiation pattern		
Antenna	Radiation efficiency	IEEE Standard Test Procedures for Antennas	ANSI/IEEE Std 149-1979

2. Test Equipment

Equipment	Model No.	Serial No.	Manufacture	Calibration Date	Next calibration Date
24 probe Microwave chamber	MPS2450 Multi-probe OTA measurement systems 5*5*5	YJ-PB-F01	XH-IOE	2023.09.01	2024.09.01
Network Analyzer	ZVB8	YJ-RD-15	ROHDE&SCHWARS	2023.08.25	2024.08.25
Wideband radio Communication tester	CMW500	YJ-RD-16	ROHDE&SCHWARS	2023.08.25	2024.08.25

3. DUT Setup Photo

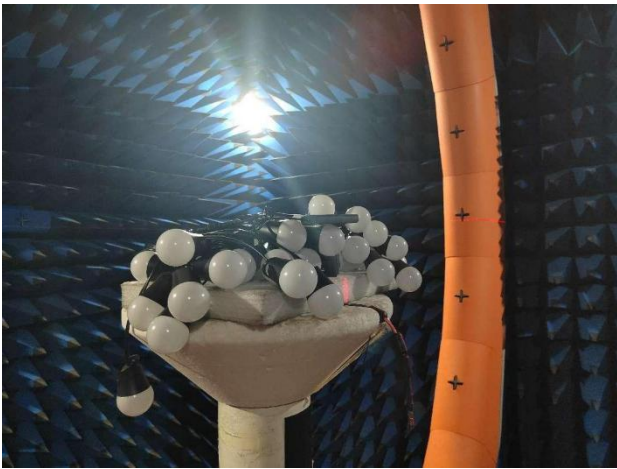

4. Bluetooth Antenna Physical Size

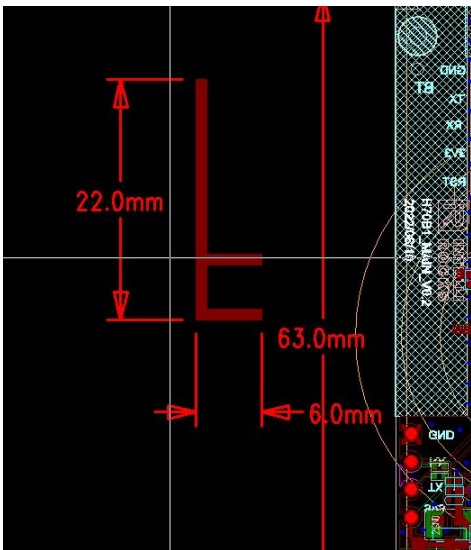

5. WIFI Antenna Physical Size

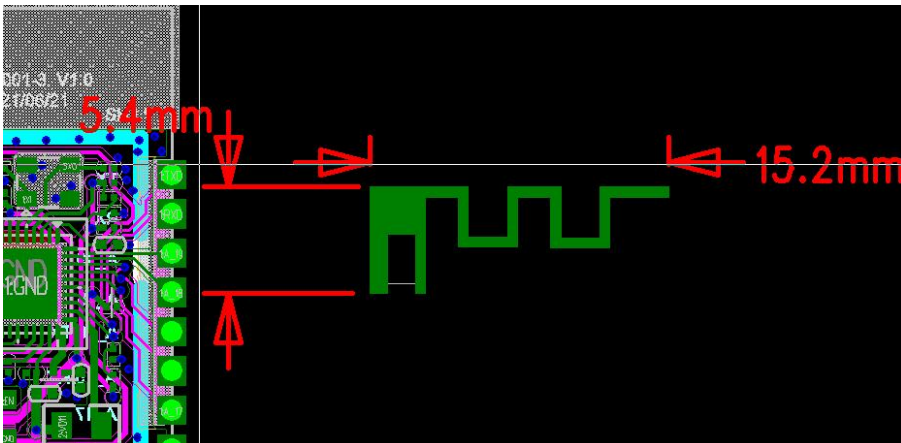

6. Bluetooth&WiFi Antenna Type & Gain

Type: PCB

Frequency / MHz	BT Gain/ dBi	WiFi Gain/ dBi
2400	3.77	3.98
2410	3.59	3.85
2420	3.3	3.46
2430	3.29	3.03
2440	3.41	2.5
2450	3.51	2.63
2460	3.54	2.83
2470	3.47	3.03
2480	3.34	3.17
2490	3.44	3.11
2500	2.93	2.97

BT:

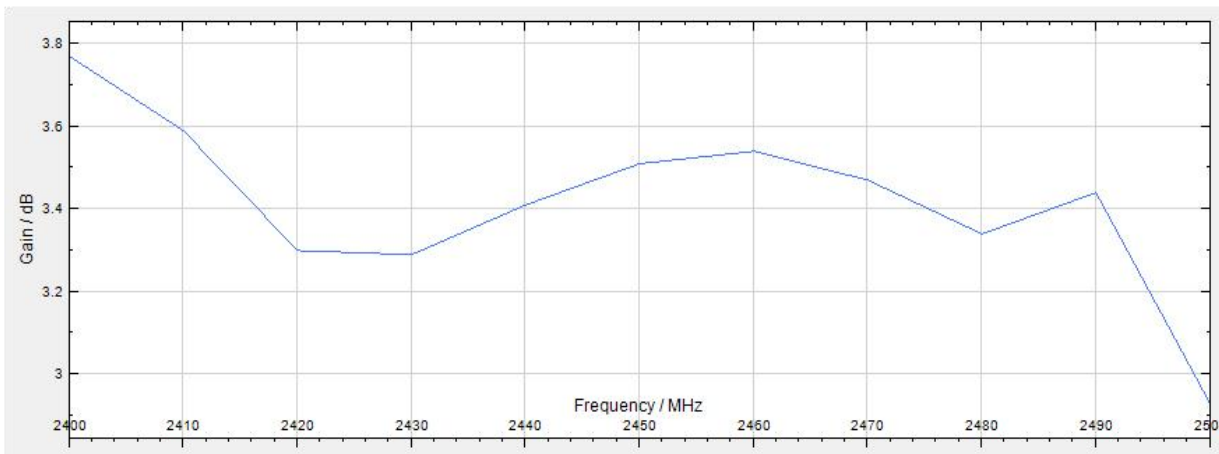

WiFi:

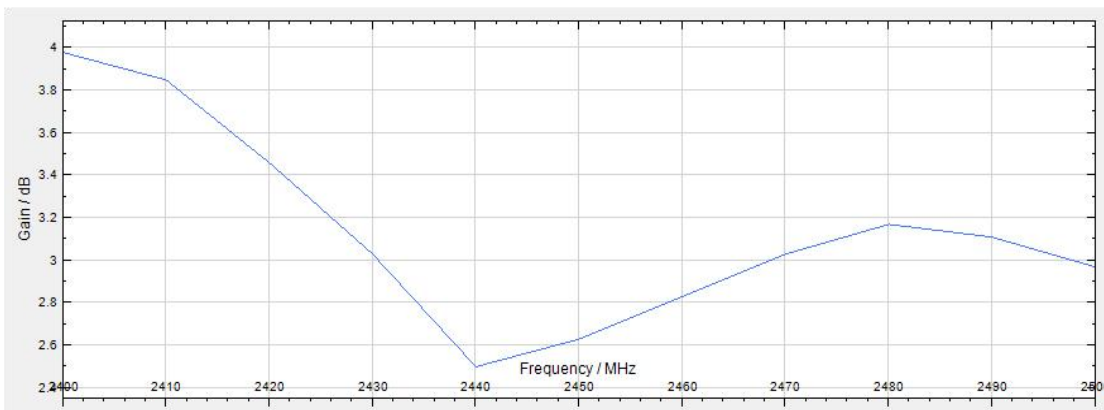

7. Bluetooth Antenna Pattern Picture

2400MHz

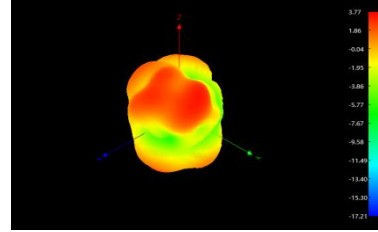
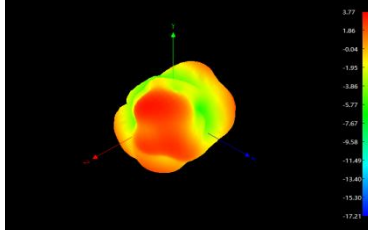
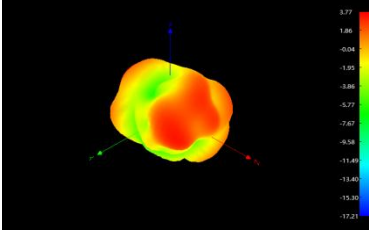

2450MHz

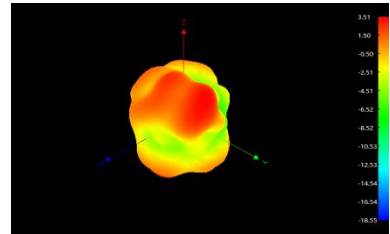
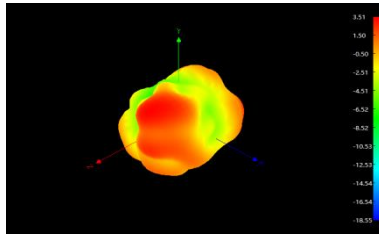
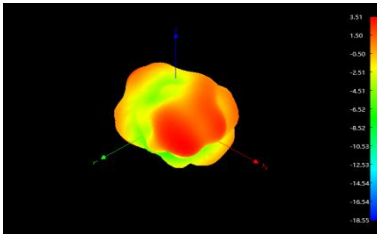

2500MHz

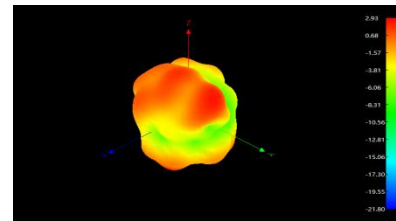
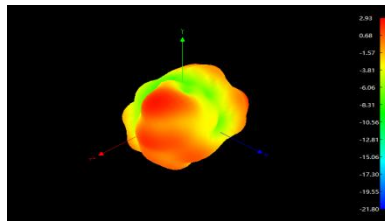
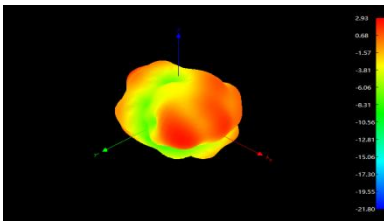

8. WiFi Antenna Pattern Picture

2400MHz

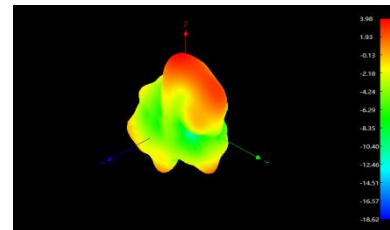
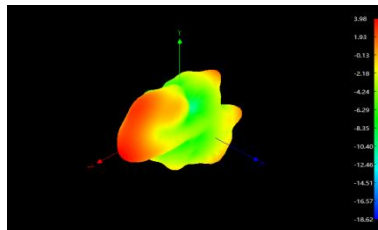
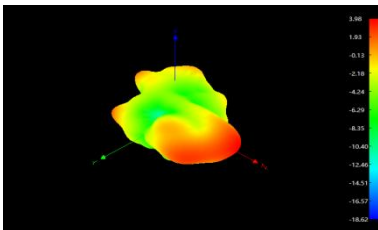

2450MHz

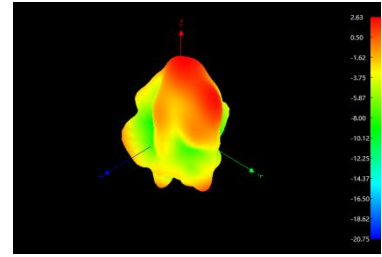
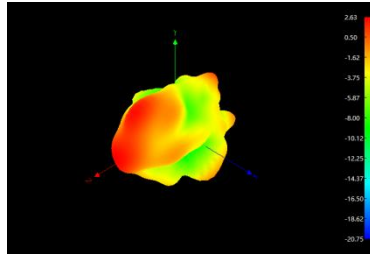
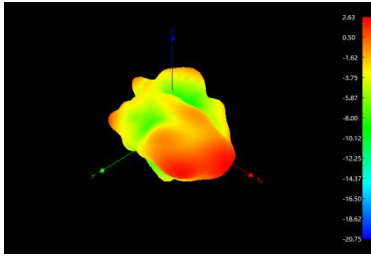

2500MHz

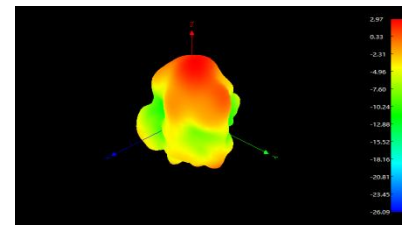
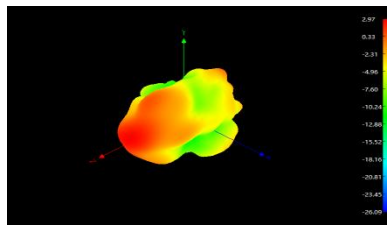
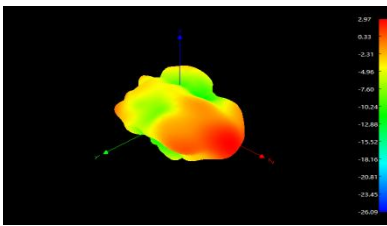

Tester by: Wu xianming

Wu Xianming