

Antenna test report

Test Laboratory	Dongguan Yijia Electronic Co., LTD
Address	No. 59 Muyu Road, Shatou Community, Chang 'an Town, Dongguan City, Guangdong Province
Contact:	Mr. Gan 13823198410
Model	H6608

1. Test procedures

Name	Parameter	Method	Standard No.
Mobile communication antenna	VSWR	Generic specification for antennas used in the mobile communications	GB/T 9410-2008
	Antenna Gain		
	Radiation pattern		
Antenna	Radiation efficiency	IEEE Standard Test Procedures for Antennas	ANSI/IEEE Std 149-1979

2. Test Equipment

Equipment	Model No.	Serial No.	Manufacture	Calibration Date	Next calibration Date
24 probe Microwave chamber	MPS2450 Multi-probe OTA measurement systems 5*5*5	YJ-PB-F01	XH-IOE	2022.09.01	2023.09.01
Network Analyzer	ZVB8	YJ-RD-15	ROHDE&SCHWARS	2022.08.25	2023.08.25
Wideband radio Communication tester	CMW500	YJ-RD-16	ROHDE&SCHWARS	2022.08.25	2023.08.25

3. DUT Setup Photo



4. Bluetooth & Wi-Fi Antenna Physical Size

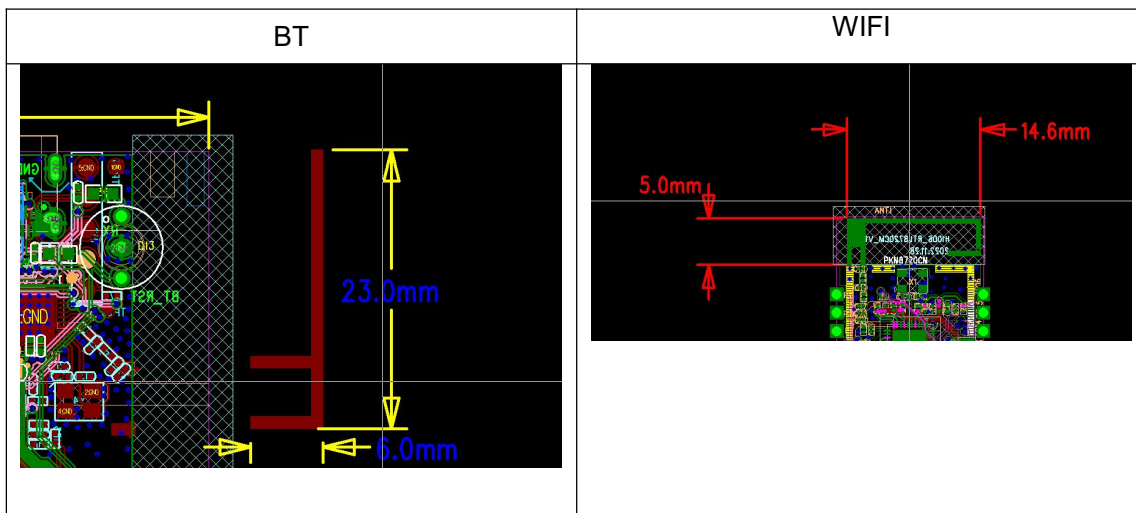

5. Bluetooth & Wi-Fi Antenna Type & Gain

Type: PCB Antenna

Frequency / MHz	BT Gain/dB	WIFI Gain/dB
2400	1.82	-2.36
2410	1.75	-2
2420	1.4	-1.81
2430	1	-1.11
2440	0.87	-0.68
2450	1	-0.34
2460	0.85	-0.2
2470	0.78	0.45
2480	0.76	0.59
2490	0.86	1
2500	0.69	0.85

BT

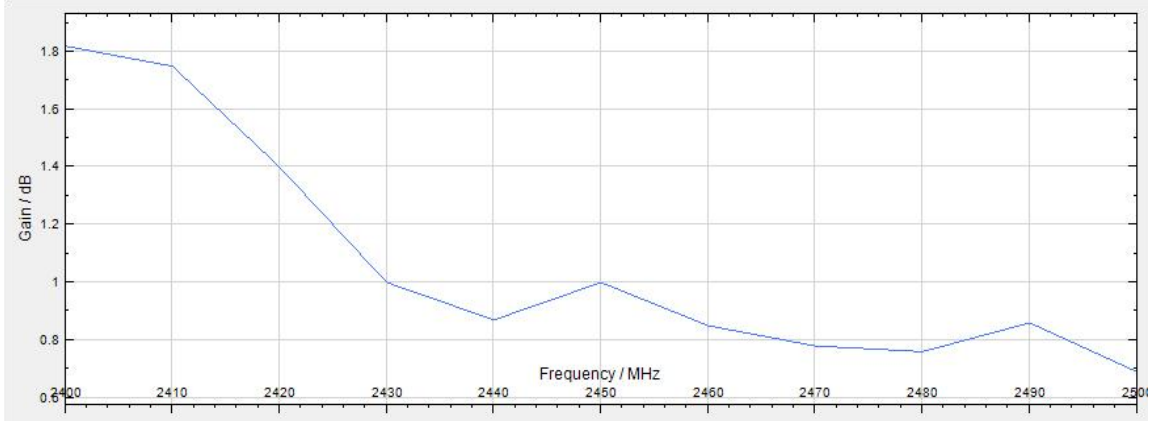

WIFI

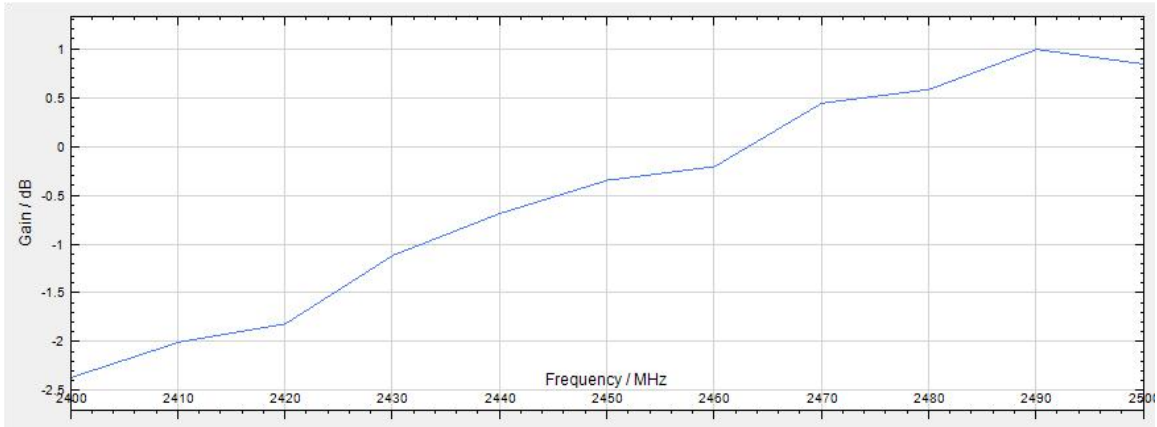

6. Bluetooth Antenna Pattern Picture

2400MHz

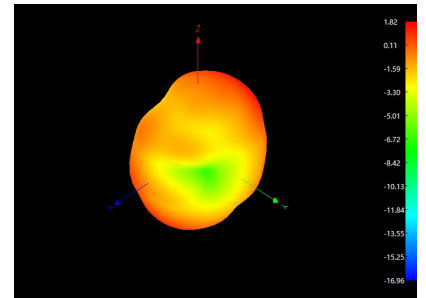
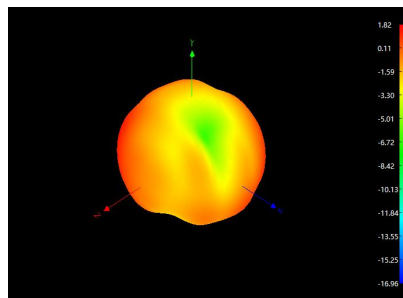
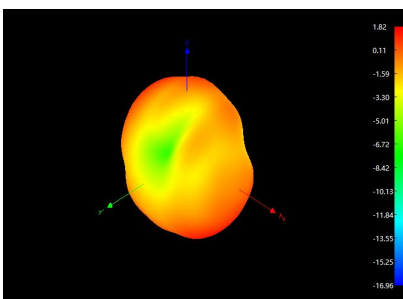

2450MHz

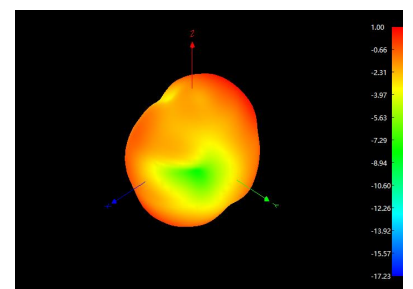
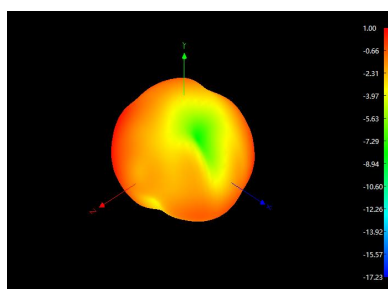
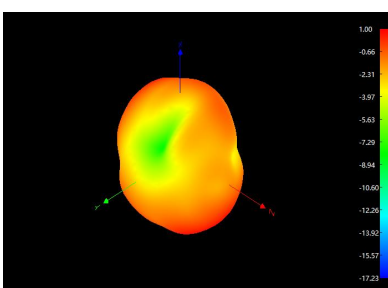

2500MHz

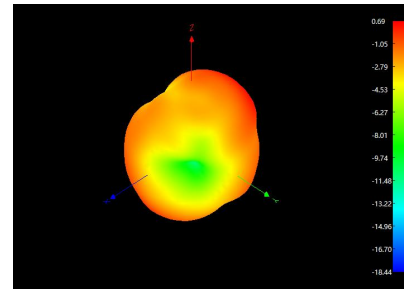
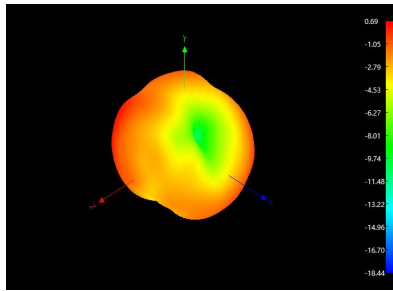
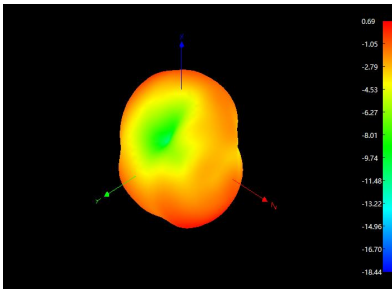

7. WIFI Antenna Pattern Picture

2400MHz

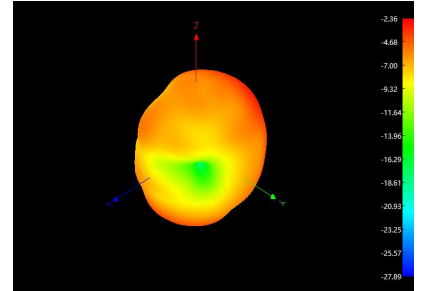
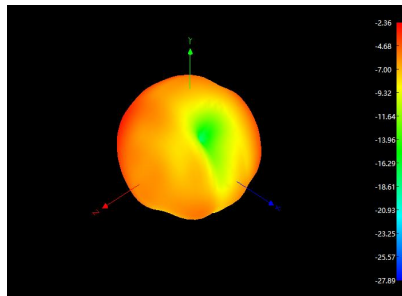
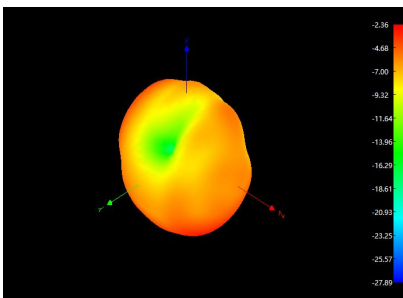

2450MHz

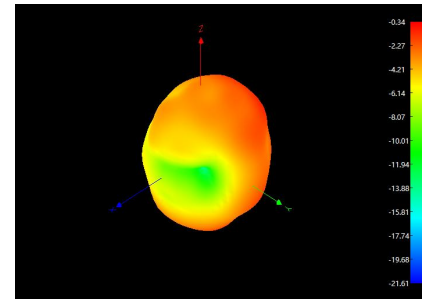
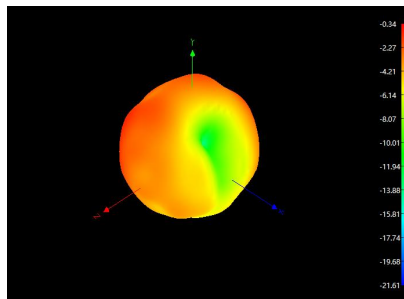
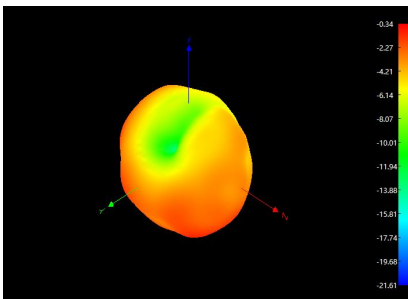

2500MHz

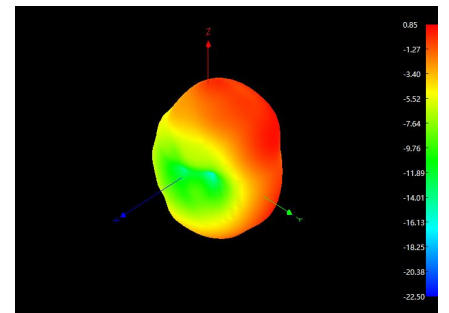
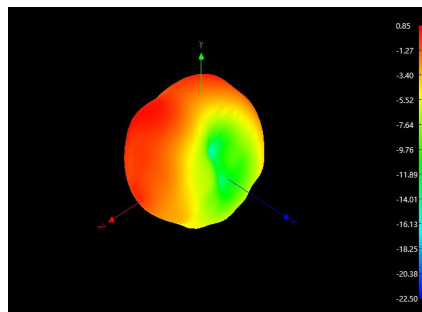
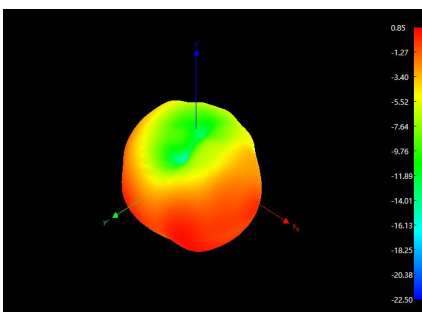

Tester by: Wu xianming

Wu Xianming