

Antenna test report

| | |
|------------------------|---|
| Test Laboratory | Dongguan Yijia Electronic Co., LTD |
| Address | No. 59 Muyu Road, Shatou Community, Chang 'an Town, Dongguan City, Guangdong Province |
| Contact: | Mr. Gan 13823198410 |
| Model | H61D5 |

1. Test procedures

| Name | Parameter | Method | Standard No. |
|------------------------------|----------------------|--|------------------------|
| Mobile communication antenna | VSWR | Generic specification for antennas used in the mobile communications | GB/T 9410-2008 |
| | Antenna Gain | | |
| | Radiation pattern | | |
| Antenna | Radiation efficiency | IEEE Standard Test Procedures for Antennas | ANSI/IEEE Std 149-1979 |

2. Test Equipment

| Equipment | Model No. | Serial No. | Manufacture | Calibration Date | Next calibration Date |
|-------------------------------------|---|------------|---------------|------------------|-----------------------|
| 24 probe Microwave chamber | MPS2450 Multi-probe OTA measurement systems 5*5*5 | YJ-PB-F01 | XH-IOE | 2023.09.01 | 2024.09.01 |
| Network Analyzer | ZVB8 | YJ-RD-15 | ROHDE&SCHWARS | 2023.08.25 | 2024.08.25 |
| Wideband radio Communication tester | CMW500 | YJ-RD-16 | ROHDE&SCHWARS | 2023.08.25 | 2024.08.25 |

3. DUT Setup Photo

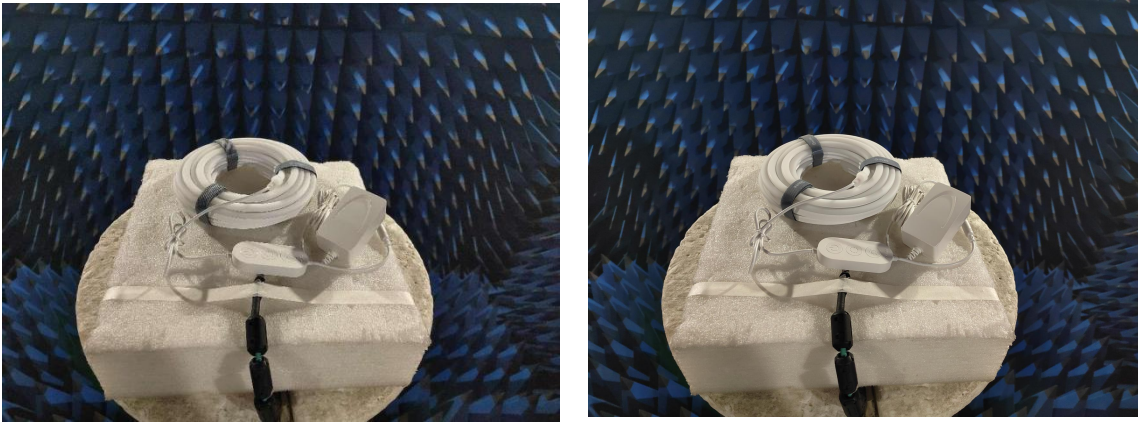

4. Bluetooth Antenna Physical Size

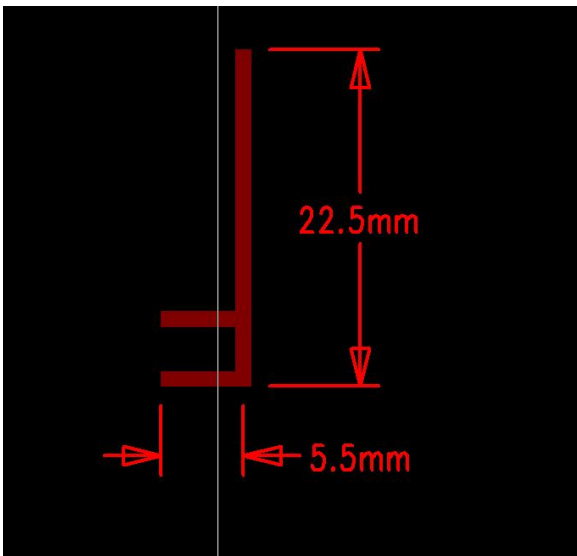

5. WIFI Antenna Physical Size

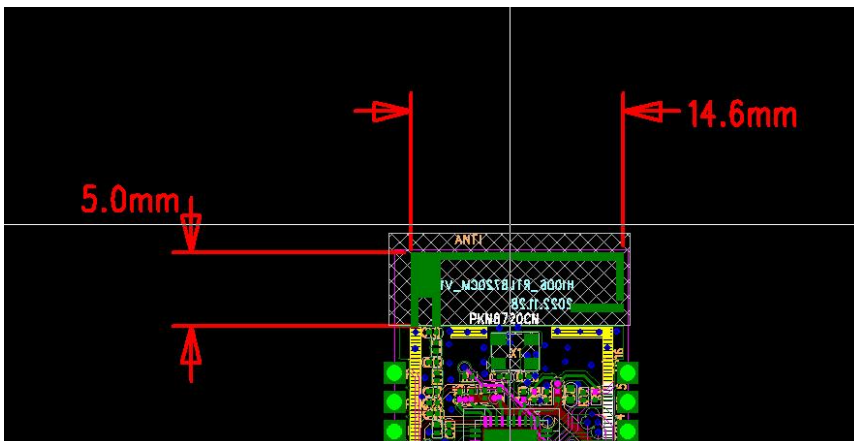

6. Bluetooth&WiFi Antenna Type & Gain

Type:

| Frequency / MHz | BT Gain/ dBi | WiFi Gain/ dBi |
|-----------------|--------------|----------------|
| 2400 | 2.3 | 1.29 |
| 2410 | 2.41 | 1.26 |
| 2420 | 2.43 | 1.05 |
| 2430 | 2.35 | 1.31 |
| 2440 | 2.08 | 1.38 |
| 2450 | 2.38 | 1.28 |
| 2460 | 1.99 | 1.3 |
| 2470 | 2.36 | 1.51 |
| 2480 | 2.14 | 1.37 |
| 2490 | 2.45 | 1.54 |
| 2500 | 2.24 | 1.4 |

BT:

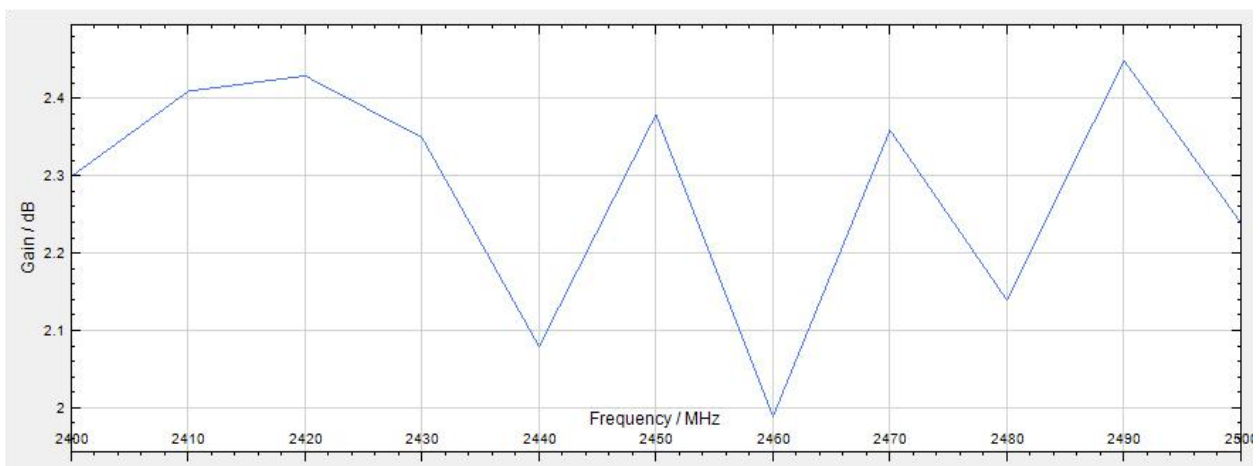

WiFi:

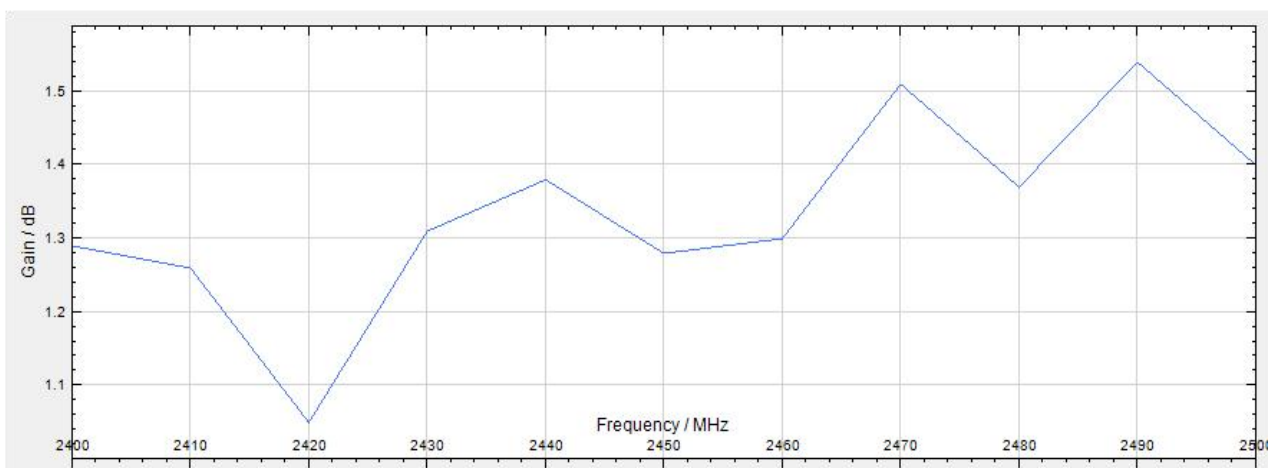

7. Bluetooth Antenna Pattern Picture

2400MHz

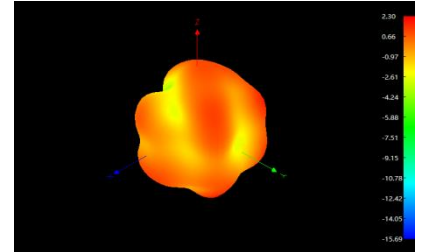
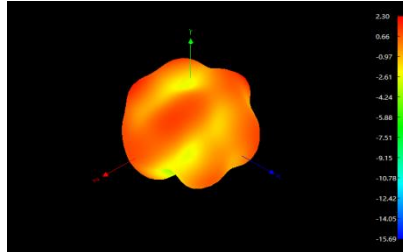
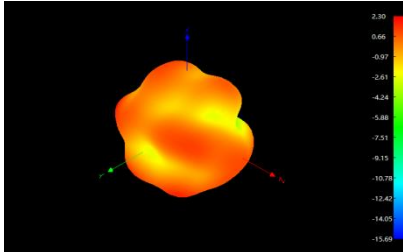

2450MHz

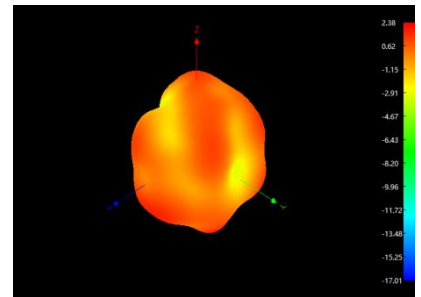
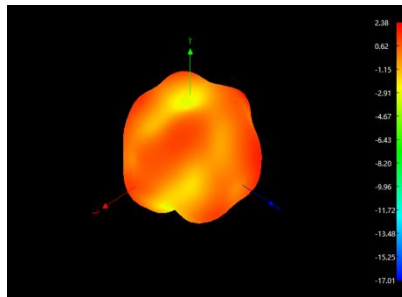
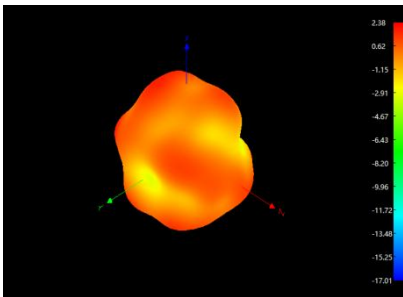

2500MHz

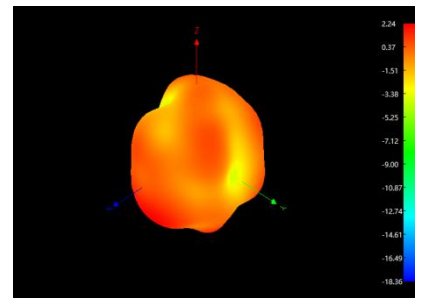
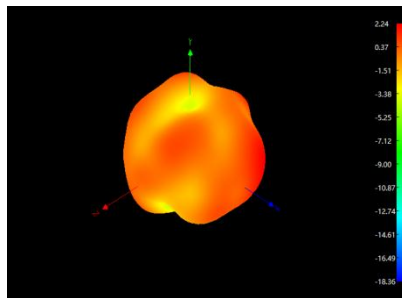
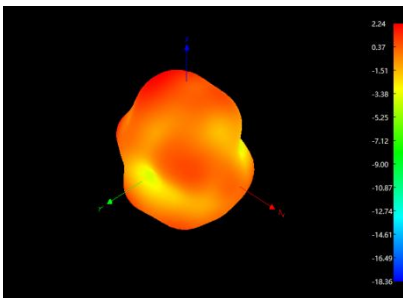

8. WiFi Antenna Pattern Picture

2400MHz

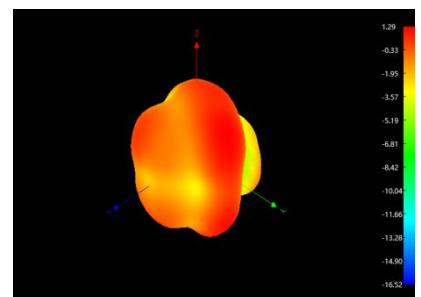
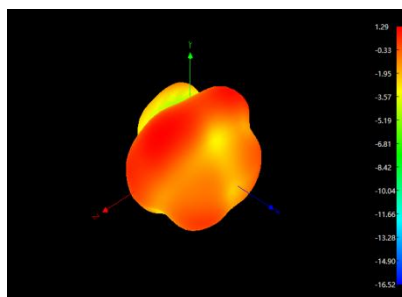
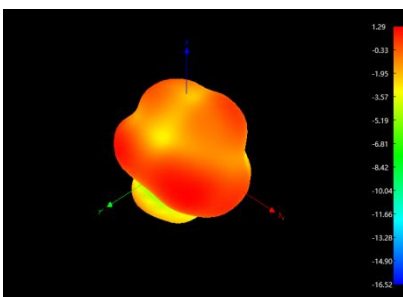

2450MHz

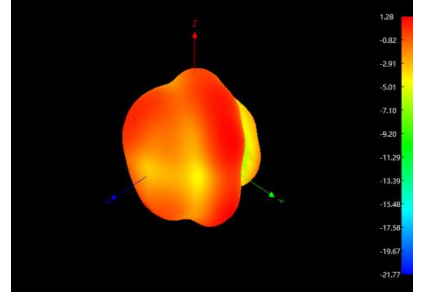
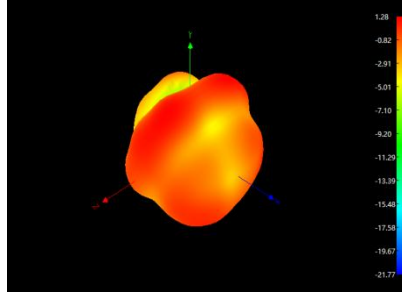
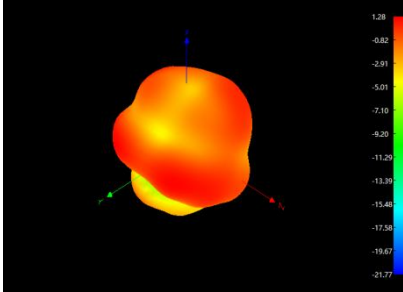

2500MHz

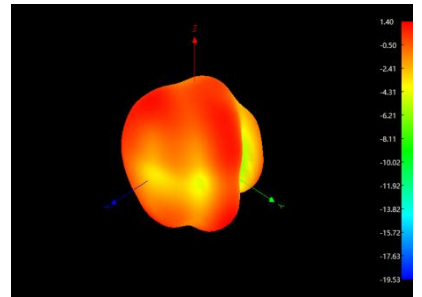
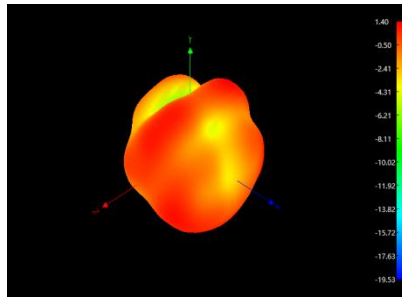
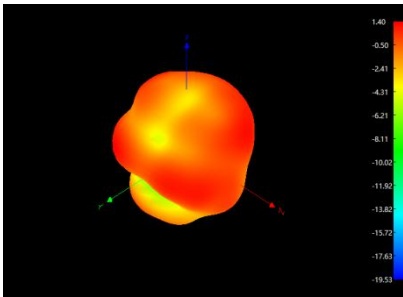

Tester by: Wu xianming

Wu Xianming