

FCC Test Report

Applicant : Shenzhen Qianyan Technology LTD

Address : No.3301,Block C,Section 1,Chuangzhi
Yuncheng, Building,Liuxian Avenue,Xili
Community, Xili Street, Nanshan District,
Shenzhen, 518000, China

Product Name : Govee RGBIC LED Neon Rope Light for desks

Report Date : Apr. 23, 2023

Shenzhen Anbotek Compliance Laboratory Limited



Shenzhen Anbotek Compliance Laboratory Limited

Address: 1/F., Building D, Sogood Science and Technology Park, Sanwei Community,
Hangcheng Street, Bao'an District, Shenzhen, Guangdong, China.
Tel: (86) 0755-26066440 Fax: (86) 0755-26014772 Email: service@anbotek.com

Code: AB-RF-05-b



Hotline

400-003-0500

www.anbotek.com.cn



Contents

1. General Information	6
1.1. Client Information	6
1.2. Description of Device (EUT)	6
1.3. Auxilliary Equipment Used During Test	7
1.4. Description of Test Configuration	7
1.5. Description Of Test Setup	8
1.6. Test Equipment List	9
1.7. Measurement Uncertainty	10
1.8. Description of Test Facility	10
2. Summary of Test Results	11
3. Conducted Emission Test	12
3.1. Test Standard and Limit	12
3.2. Test Setup	12
3.3. Test Procedure	12
3.4. Test Data	12
4. Radiation Spurious Emission and Band Edge	15
4.1. Test Standard and Limit	15
4.2. Test Setup	15
4.3. Test Procedure	16
4.4. Test Data	17
5. Maximum Peak Output Power Test	26
5.1. Test Standard and Limit	26
5.2. Test Setup	26
5.3. Test Procedure	26
5.4. Test Data	26
6. 6dB Occupy Bandwidth Test	27
6.1. Test Standard and Limit	27
6.2. Test Setup	27
6.3. Test Procedure	27
6.4. Test Data	27
7. Power Spectral Density Test	28
7.1. Test Standard and Limit	28
7.2. Test Setup	28
7.3. Test Procedure	28
7.4. Test Data	28
8. 100kHz Bandwidth of Frequency Band Edge Requirement	29
8.1. Test Standard and Limit	29



8.2. Test Setup	29
8.3. Test Procedure	29
8.4. Test Data	29
9. Antenna Requirement	30
9.1. Test Standard and Requirement	30
9.2. Antenna Connected Construction	30
APPENDIX I -- TEST SETUP PHOTOGRAPH	31
APPENDIX II -- EXTERNAL PHOTOGRAPH	31
APPENDIX III -- INTERNAL PHOTOGRAPH	31



TEST REPORT

Applicant : Shenzhen Qianyan Technology LTD
Manufacturer : Shenzhen Qianyan Technology LTD
Product Name : Govee RGBIC LED Neon Rope Light for desks
Model No. : H61C3
Trade Mark : Govee
Rating(s) : Input: 24V= 1.5A

Test Standard(s) : FCC Part15 Subpart C, Section 15.247

Test Method(s) : ANSI C63.10: 2020, KDB 558074 D01 15.247 Meas Guidance v05r02

The device described above is tested by Shenzhen Anbotek Compliance Laboratory Limited to determine the maximum emission levels emanating from the device and the severe levels of the device can endure and its performance criterion. The measurement results are contained in this test report and Shenzhen Anbotek Compliance Laboratory Limited is assumed full of responsibility for the accuracy and completeness of these measurements. Also, this report shows that the EUT (Equipment Under Test) is technically compliant with the FCC Part 15 Subpart C requirements.

This report applies to above tested sample only and shall not be reproduced in part without written approval of Shenzhen Anbotek Compliance Laboratory Limited.

Date of Receipt

Feb. 20, 2023

Date of Test

Feb. 20 ~ Apr. 14, 2023

Prepared by

Nian Xiu Chen

(Nianxiu Chen)

Approved & Authorized Signer

Kingkong Jin

(Kingkong Jin)



Revision History

Report Version	Description	Issued Date
R00	Original Issue.	Apr. 23, 2023



1. General Information

1.1. Client Information

Applicant	:	Shenzhen Qianyan Technology LTD
Address	:	No.3301,Block C,Section 1,Chuangzhi Yuncheng, Building,Liuxian Avenue,Xili Community, Xili Street, Nanshan District, Shenzhen, 518000, China
Manufacturer	:	Shenzhen Qianyan Technology LTD
Address	:	No.3301,Block C,Section 1,Chuangzhi Yuncheng, Building,Liuxian Avenue,Xili Community, Xili Street, Nanshan District, Shenzhen, 518000, China

1.2. Description of Device (EUT)

Product Name	:	Govee RGBIC LED Neon Rope Light for desks
Model No.	:	H61C3
Trade Mark	:	Govee
Test Power Supply	:	AC 120V, 60Hz for Adapter
Test Sample No.	:	1-2-1(Normal Sample), 1-2-2(Engineering Sample)
Adapter	:	Model: BI36L240150-AdU Input: 100-240V~ 50/60Hz 1.2A Output: 24V= 1.5A

RF Specification

Operation Mode	:	<input checked="" type="checkbox"/> 802.11b <input checked="" type="checkbox"/> 802.11g <input checked="" type="checkbox"/> 802.11n(HT20) <input type="checkbox"/> 802.11n(HT40)
Operation Frequency	:	2412~2462MHz
Number of Channel	:	11 Channel for 20MHz bandwidth (2412~2462MHz)
Modulation Type	:	<input checked="" type="checkbox"/> 802.11b: DSSS (CCK, DQPSK, DBPSK) <input checked="" type="checkbox"/> 802.11g: OFDM (BPSK, QPSK, 16QAM, 64QAM) <input checked="" type="checkbox"/> 802.11n: OFDM (BPSK, QPSK, 16QAM, 64QAM)
Antenna Type	:	PCB Antenna
Antenna Gain(Peak)	:	3.85dBi (Provided by customer)

Remark: 1) For a more detailed features description, please refer to the manufacturer's specifications or the User's Manual.



1.3. Auxiliary Equipment Used During Test

Description	Rating(s)
--	--

1.4. Description of Test Configuration

Channel	Freq. (MHz)	Channel	Freq. (MHz)	Channel	Freq. (MHz)	Channel	Freq. (MHz)
01	2412	04	2427	07	2442	10	2457
02	2417	05	2432	08	2447	11	2462
03	2422	06	2437	09	2452		

Note:

1. The engineering test program was provided and the EUT was programmed to be in continuously transmitting mode.
2. For 802.11b, 802.11g, and 802.11n(HT20) modes were test with channel 1, 6, 11.



1.5. Description Of Test Setup

CE

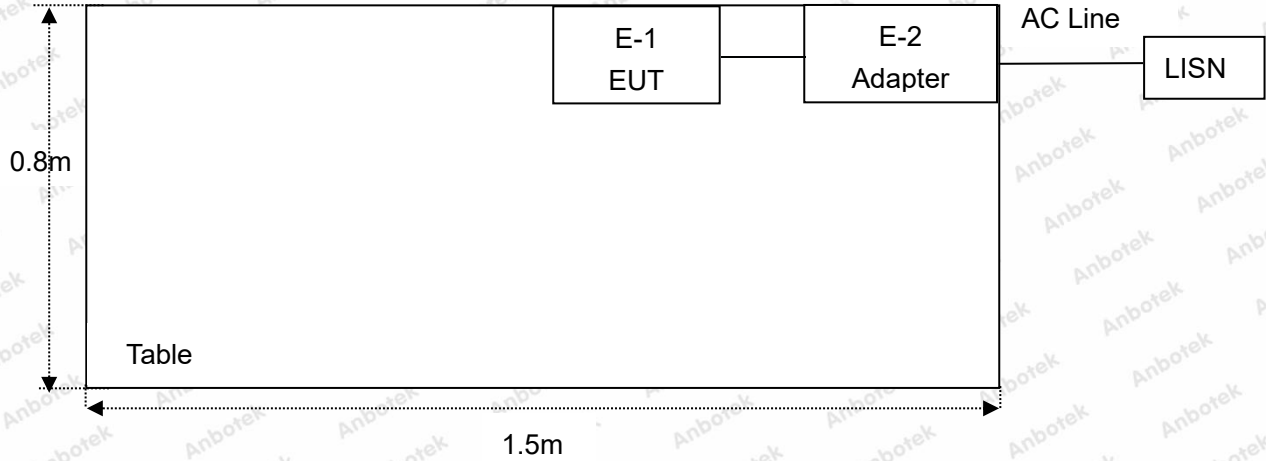

RE

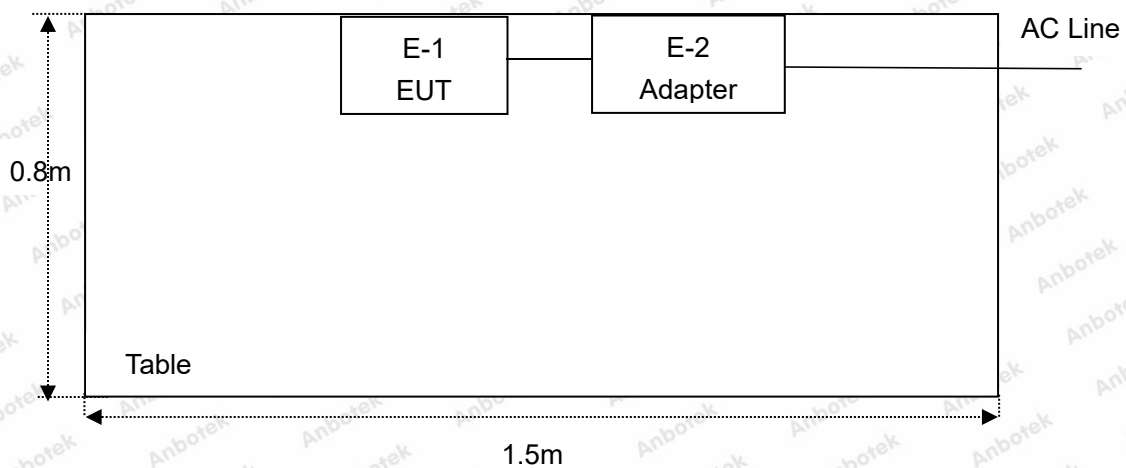

1.6. Test Equipment List

Item	Equipment	Manufacturer	Model No.	Serial No.	Last Cal.	Cal. Interval
1.	L.I.S.N. Artificial Mains Network	Rohde & Schwarz	ENV216	100055	Oct. 23, 2022	1 Year
2.	Three Phase V-type Artificial Power Network	CYBERTEK	EM5040DT	E215040DT001	Jul. 05, 2022	1 Year
3.	EMI Test Receiver	Rohde & Schwarz	ESCI	100627	Oct. 13, 2022	1 Year
4.	EMI Test Receiver	Rohde & Schwarz	ESR26	101481	Oct. 23, 2022	1 Year
5.	RF Switching Unit	Compliance Direction	RSU-M2	38303	Oct. 22, 2022	1 Year
6.	MXA Spectrum Analysis	Agilent	N9020A	MY51170037	Oct. 13, 2022	1 Year
7.	EMI Pre-amplifier	SKET Electronic	LNPA-0118G-45	SKET-PA-002	Oct. 13, 2022	1 Year
8.	Double Ridged Horn Antenna	SCHWARZBECK	BBHA 9120D	02555	Oct. 16, 2022	3 Year
9.	Bilog Broadband Antenna	Schwarzbeck	VULB9163	VULB 9163-289	Oct. 23, 2022	1 Year
10.	Loop Antenna	Schwarzbeck	FMZB1519B	00053	Oct. 23, 2022	1 Year
11.	Horn Antenna	A-INFO	LB-180400-KF	J211060628	Oct. 23, 2022	1 Year
12.	Pre-amplifier	SONOMA	310N	186860	Oct. 23, 2022	1 Year
13.	EMI Test Software EZ-EMC	SHURPLE	N/A	N/A	N/A	N/A
14.	MXA Spectrum Analysis	KEYSIGHT	N9020A	MY53280032	Oct. 13, 2022	1 Year
15.	MXG RF Vector Signal Generator	Agilent	N5182A	MY48180656	Oct. 13, 2022	1 Year
16.	Signal Generator	Agilent	E4421B	MY41000743	Oct. 13, 2022	1 Year
17.	DC Power Supply	IVYTECH	IV3605	1804D360510	Oct. 22, 2022	1 Year
18.	Constant Temperature Humidity Chamber	ZHONGJIAN	ZJ-KHWS80B	N/A	Oct. 19, 2022	1 Year
19.	Power Meter	Agilent	N1914A	MY50001102	Oct.26, 2022	1 Year



1.7. Measurement Uncertainty

Radiation Uncertainty	:	Ur = 3.9 dB (Horizontal)
	:	Ur = 3.8 dB (Vertical)
Conduction Uncertainty	:	Uc = 3.4 dB

1.8. Description of Test Facility

The test facility is recognized, certified, or accredited by the following organizations:

FCC-Registration No.: 184111

Shenzhen Anbotek Compliance Laboratory Limited, EMC Laboratory has been registered and fully described in a report filed with the (FCC) Federal Communications Commission. The acceptance letter from the FCC is maintained in our files. Registration No. 184111.

ISED-Registration No.: 8058A

Shenzhen Anbotek Compliance Laboratory Limited, EMC Laboratory has been registered and fully described in a report filed with the (ISED) Innovation, Science and Economic Development Canada. The acceptance letter from the ISED is maintained in our files. Registration 8058A.

Test Location

Shenzhen Anbotek Compliance Laboratory Limited.

1/F, Building D, Sogood Science and Technology Park, Sanwei community, Hangcheng Street, Bao'an District, Shenzhen, Guangdong, China.518102



2. Summary of Test Results

Standard Section	Test Item	Result
15.203/15.247(c)	Antenna Requirement	PASS
15.207	Conducted Emission	PASS
15.205/15.209	Spurious Emission	PASS
15.247(b)(3)	Conducted Peak Output Power	PASS
15.247(a)(2)	6dB Occupied Bandwidth	PASS
15.247(e)	Power Spectral Density	PASS
15.247(d)	Band Edge	PASS
Remark: "N/A" is an abbreviation for Not Applicable.		



3. Conducted Emission Test

3.1. Test Standard and Limit

Test Standard	FCC Part15 Section 15.207		
Test Limit	Frequency	Maximum RF Line Voltage (dBuV)	
		Quasi-peak Level	Average Level
	150kHz~500kHz	66 ~ 56 *	56 ~ 46 *
	500kHz~5MHz	56	46
5MHz~30MHz	60	50	

Remark: (1) *Decreasing linearly with logarithm of the frequency.
 (2) The lower limit shall apply at the transition frequency.

3.2. Test Setup

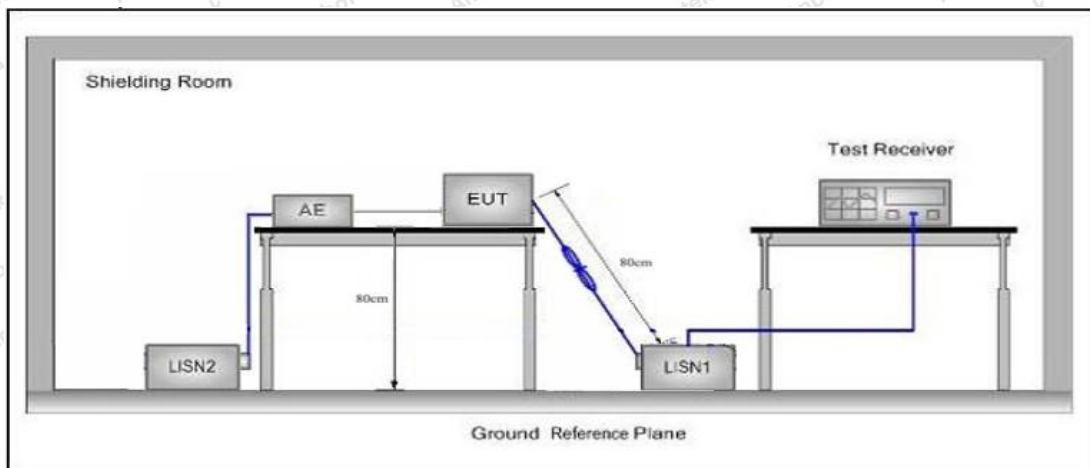

3.3. Test Procedure

The EUT system is connected to the power mains through a line impedance stabilization network (L.I.S.N.). This provides a 50ohm coupling impedance for the EUT system. Please refer the block diagram of the test setup and photographs. Both sides of AC line are checked to find out the maximum conducted emission. In order to find the maximum emission levels, the relative positions of equipment and all of the interface cables shall be changed according to FCC ANSI C63.10: 2020 on Conducted Emission Measurement.

The bandwidth of test receiver (ESCI) set at 9kHz.

The frequency range from 150kHz to 30MHz is checked.

3.4. Test Data

During the test, pre-scan all modes, only the worst case is recorded in the report.

AC conducted emission pre-test at both at AC 120V/60Hz and AC 240V/60Hz modes, recorded worst case AC 120V/60Hz.

Please to see the following pages.



Conducted Emission Test Data

Test Site: 1# Shielded Room
 Operating Condition: 802.11g 2462MHz
 Test Specification: AC 120V, 60Hz for Adapter
 Comment: Live Line
 Temp.(°C)/Hum.(%RH): 22.4°C/47%RH

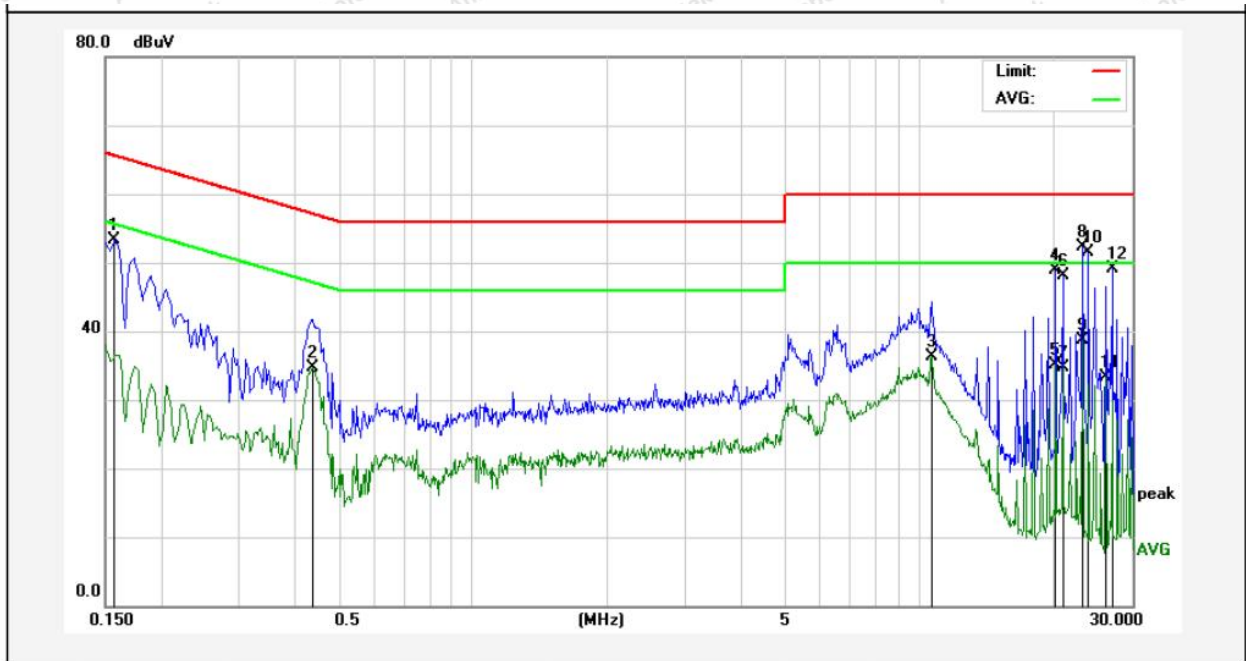

No.	Freq. (MHz)	Reading (dBuV)	Factor (dB)	Result (dBuV)	Limit (dBuV)	Over Limit (dB)	Detector	Remark
1	0.1580	43.55	9.83	53.38	65.56	-12.18	QP	
2	0.4380	24.83	9.83	34.66	47.10	-12.44	AVG	
3	10.6260	26.23	10.00	36.23	50.00	-13.77	AVG	
4	20.2500	38.64	10.29	48.93	60.00	-11.07	QP	
5	20.2500	24.81	10.29	35.10	50.00	-14.90	AVG	
6	21.0020	37.83	10.32	48.15	60.00	-11.85	QP	
7	21.0020	24.47	10.32	34.79	50.00	-15.21	AVG	
8	23.2500	41.84	10.42	52.26	60.00	-7.74	QP	
9	23.2500	28.24	10.42	38.66	50.00	-11.34	AVG	
10	24.0020	41.13	10.45	51.58	60.00	-8.42	QP	
11	26.2460	22.76	10.55	33.31	50.00	-16.69	AVG	
12	26.9980	38.61	10.59	49.20	60.00	-10.80	QP	



Conducted Emission Test Data

Test Site: 1# Shielded Room
 Operating Condition: 802.11g 2462MHz
 Test Specification: AC 120V, 60Hz for Adapter
 Comment: Neutral Line
 Temp.(°C)/Hum.(%RH): 22.4°C/47%RH

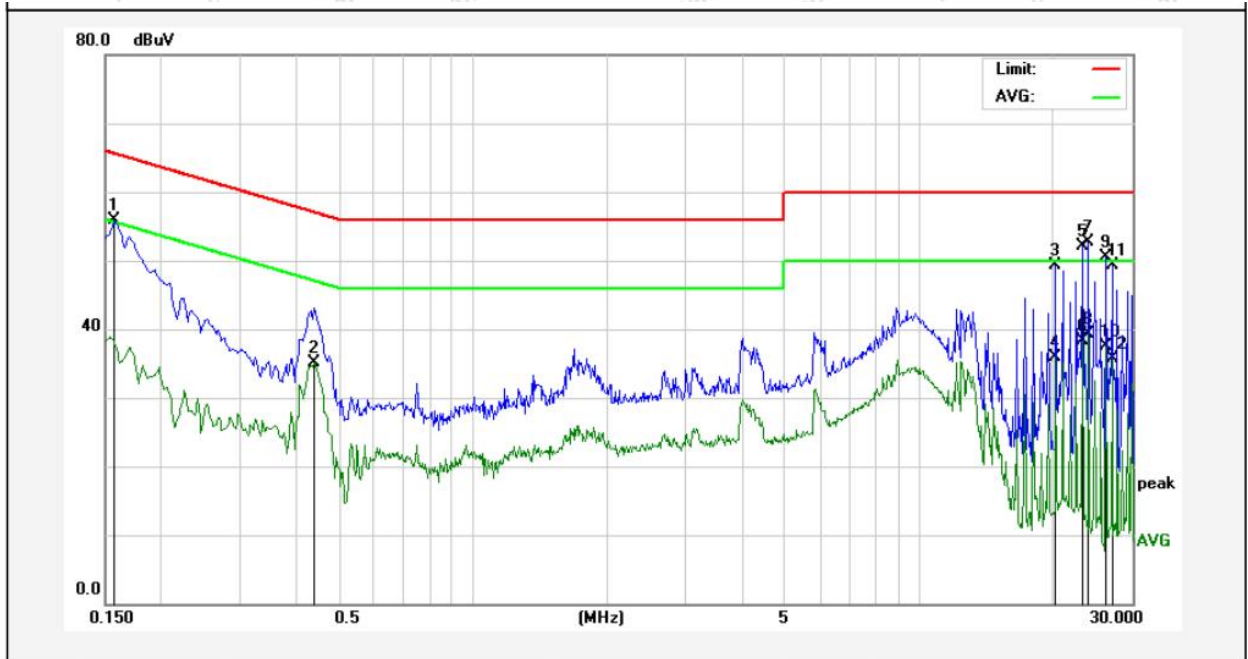

No.	Freq. (MHz)	Reading (dBUV)	Factor (dB)	Result (dBUV)	Limit (dBUV)	Over Limit (dB)	Detector	Remark
1	0.1580	46.12	9.83	55.95	65.56	-9.61	QP	
2	0.4420	25.29	9.83	35.12	47.02	-11.90	AVG	
3	20.2500	39.01	10.29	49.30	60.00	-10.70	QP	
4	20.2500	25.67	10.29	35.96	50.00	-14.04	AVG	
5	23.2500	41.65	10.42	52.07	60.00	-7.93	QP	
6	23.2500	27.97	10.42	38.39	50.00	-11.61	AVG	
7	23.9980	42.21	10.45	52.66	60.00	-7.34	QP	
8	23.9980	28.84	10.45	39.29	50.00	-10.71	AVG	
9	26.2500	40.05	10.55	50.60	60.00	-9.40	QP	
10	26.2500	26.97	10.55	37.52	50.00	-12.48	AVG	
11	26.9980	38.68	10.59	49.27	60.00	-10.73	QP	
12	26.9980	25.18	10.59	35.77	50.00	-14.23	AVG	



4. Radiation Spurious Emission and Band Edge

4.1. Test Standard and Limit

Test Standard	FCC Part15 C Section 15.209 and 15.205				
Test Limit	Frequency (MHz)	Field strength (microvolt/meter)	Limit (dBuV/m)	Remark	Measurement distance (m)
	0.009MHz~0.490MHz	2400/F(kHz)	-	-	300
	0.490MHz-1.705MHz	24000/F(kHz)	-	-	30
	1.705MHz-30MHz	30	-	-	30
	30MHz~88MHz	100	40.0	Quasi-peak	3
	88MHz~216MHz	150	43.5	Quasi-peak	3
	216MHz~960MHz	200	46.0	Quasi-peak	3
	960MHz~1000MHz	500	54.0	Quasi-peak	3
	Above 1000MHz	500	54.0	Average	3
-		74.0	Peak	3	

Remark:

(1)The lower limit shall apply at the transition frequency.

(2) 15.35(b), Unless otherwise specified, the limit on peak radio frequency emissions is 20dB above the maximum permitted average emission limit applicable to the equipment under test. This peak limit applies to the total peak emission level radiated by the device.

4.2. Test Setup

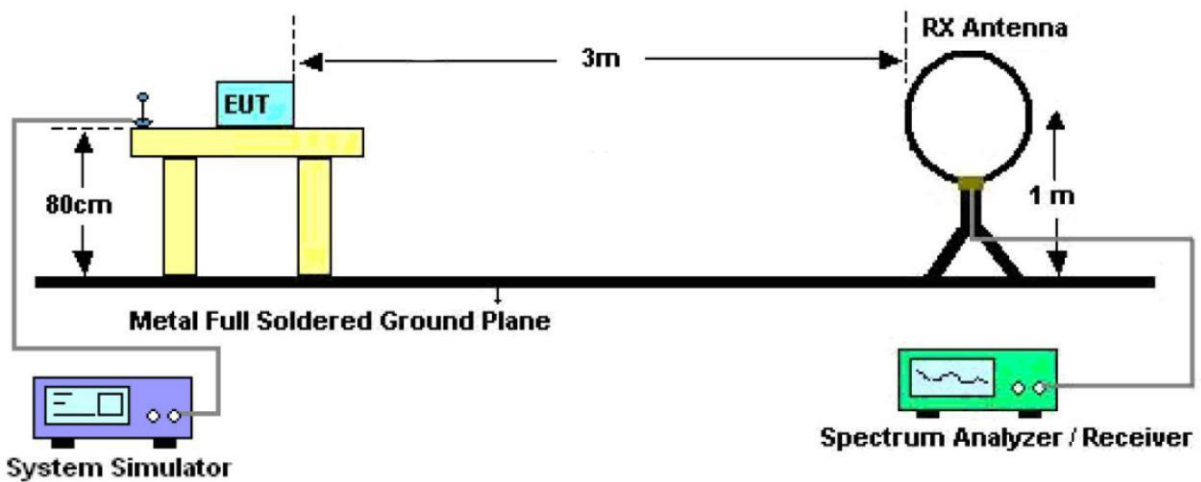

Figure 1. Below 30MHz



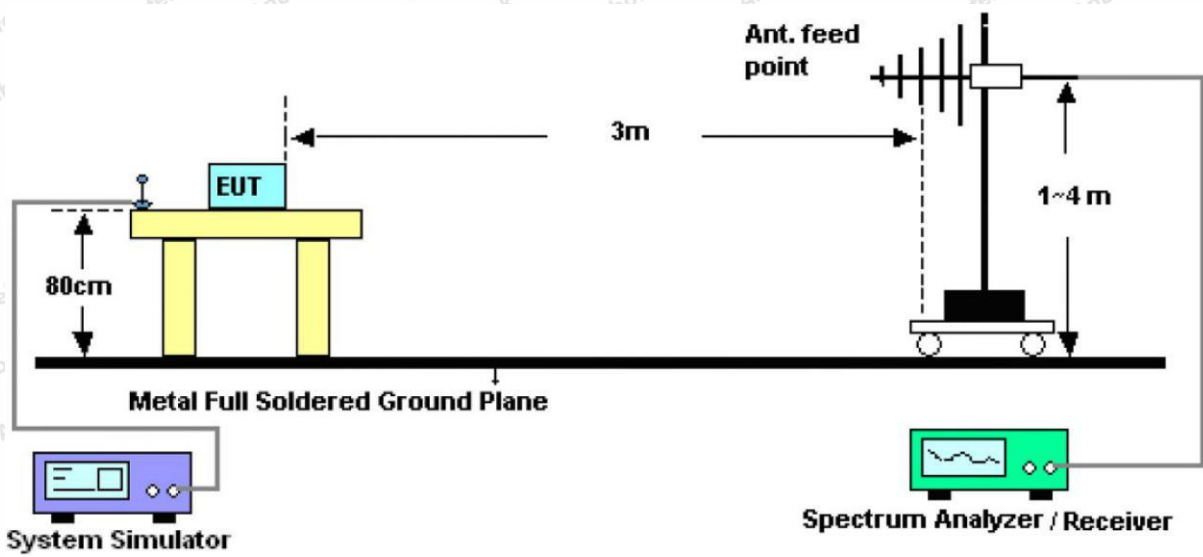

Figure 2. 30MHz to 1GHz

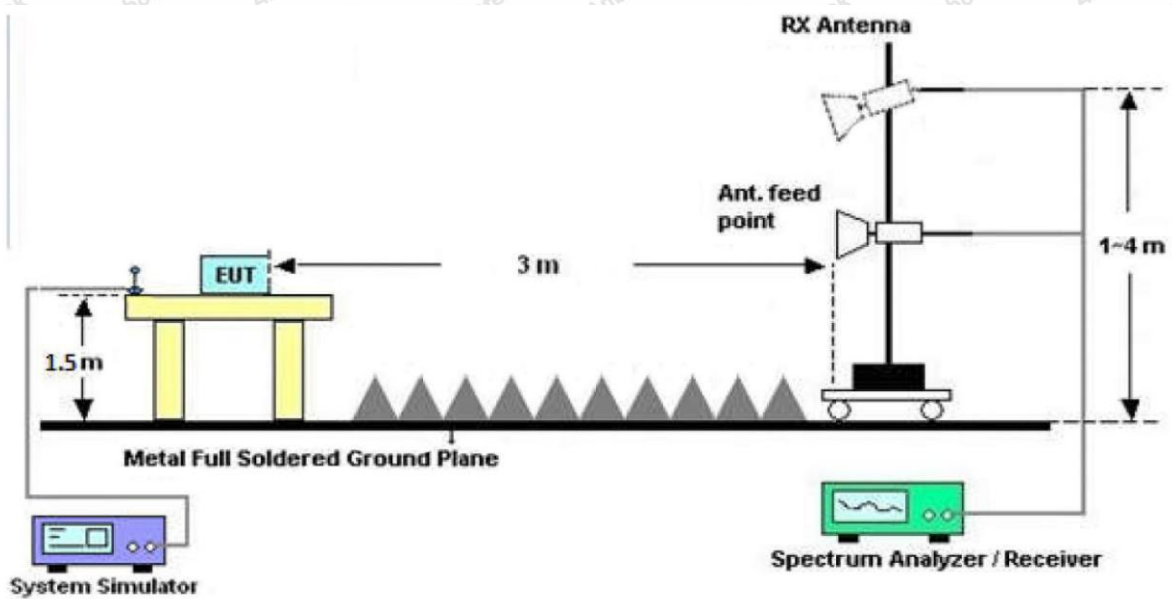

Figure 3. Above 1 GHz

4.3. Test Procedure

For below 1GHz: The EUT is placed on a turntable, which is 0.8m above the ground plane.

For above 1GHz: The EUT is placed on a turntable, which is 1.5m above the ground plane.

The turn table can rotate 360 degrees to determine the position of the maximum emission level. The EUT is set 3 meters away from the receiving antenna which is mounted on an antenna tower. The antenna can be moved up and down from 1 to 4 meters to find out the maximum emission level. Rotated the EUT through three orthogonal axes to determine the maximum emissions, both horizontal and vertical polarization of the antenna are set on test. The EUT is tested in 9*6*6 Chamber. The device is evaluated in xyz orientation.



For the radiated emission test above 1GHz:

Place the measurement antenna away from each area of the EUT determined to be a source of emissions at the specified measurement distance, while keeping the measurement antenna aimed at the source of emissions at each frequency of significant emissions, with polarization oriented for maximum response. The measurement antenna may have to be higher or lower than the EUT, depending on the radiation pattern of the emission and staying aimed at the emission source for receiving the maximum signal. The final measurement antenna elevation shall be that which maximizes the emissions. The measurement antenna elevation for maximum emissions shall be restricted to a range of heights of from 1 m to 4 m above the ground or reference ground plane.

For 9kHz to 150kHz, Set the spectrum analyzer as:

RBW = 200Hz, VBW = 1kHz, Detector= Quasi-Peak, Trace mode= Max hold, Sweep- auto couple.

For 150kHz to 30MHz, Set the spectrum analyzer as:

RBW = 9kHz, VBW = 30kHz, Detector= Quasi-Peak, Trace mode= Max hold, Sweep- auto couple.

For 30MHz to 1000MHz, Set the spectrum analyzer as:

RBW = 100kHz, VBW = 300kHz, Detector= Quasi-Peak, Trace mode= Max hold, Sweep- auto couple.

For above 1GHz, Set the spectrum analyzer as:

RBW = 1MHz, VBW = 1MHz, Detector= Peak, Trace mode= Max hold, Sweep- auto couple.

For average measurement:

–VBW=10Hz, When duty cycle is no less than 98 percent

–VBW $\geq 1/T$, when duty cycle is less than 98 percent where T is the minimum transmission duration over which the transmitter is on and is transmitting at its maximum power control level for the tested mode of operation, so refer to this clause 5.4 duty cycle.

4.4. Test Data

PASS

During the test, Pre-scan all kind of the place mode (X-axis, Y-axis, Z-axis), and found the X-axis is the worst case.

The test results of 9kHz-30MHz was attenuated more than 20dB below the permissible limits, so the results don't record in the report.

During the test, pre-scan all modes, only the worst case is recorded in the report.



Test Results (30~1000MHz)

Test Mode: 802.11g 2462MHz
 Power Source: AC 120V, 60Hz for Adapter
 Polarization: Horizontal
 Temp.(°C)/Hum.(%RH): 23.5°C/48%RH



No.	Freq. (MHz)	Reading (dBuV)	Factor ()	Result (dBuV/m)	Limit (dBuV/m)	Over Limit (dB)	Detector	Height (cm)	degree (deg)	Remark
1	39.7146	37.32	-16.92	20.40	40.00	-19.60	QP			
2	55.4147	40.87	-17.45	23.42	40.00	-16.58	QP			
3	65.4579	39.76	-19.85	19.91	40.00	-20.09	QP			
4	101.4663	46.94	-17.14	29.80	43.50	-13.70	QP			
5	208.2148	52.31	-17.83	34.48	43.50	-9.02	QP			
6	290.5262	46.54	-15.08	31.46	46.00	-14.54	QP			



Test Results (30~1000MHz)

Test Mode: 802.11g 2462MHz
 Power Source: AC 120V, 60Hz for Adapter
 Polarization: Vertical
 Temp.(°C)/Hum.(%RH): 23.5°C/48%RH

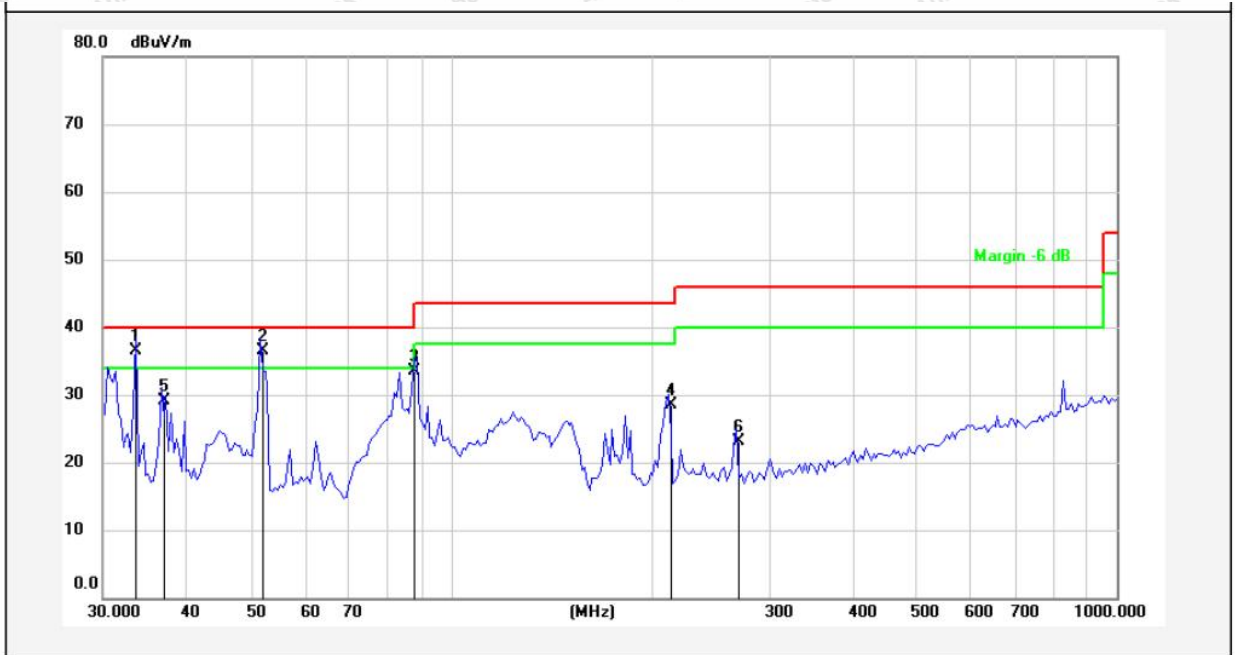

No.	Freq. (MHz)	Reading (dBuV)	Factor ()	Result (dBuV/m)	Limit (dBuV/m)	Over Limit (dB)	Detector	Height (cm)	degree (deg)	Remark
1	33.6213	54.60	-18.05	36.55	40.00	-3.45	QP			
2	51.6616	53.69	-17.26	36.43	40.00	-3.57	QP			
3	88.1873	52.38	-18.93	33.45	43.50	-10.05	QP			
4	211.8977	46.13	-17.67	28.46	43.50	-15.04	QP			
5	36.7018	46.70	-17.64	29.06	40.00	-10.94	QP			
6	268.4853	38.67	-15.61	23.06	46.00	-22.94	QP			



Test Results (Above 1000MHz)

Test Mode: 802.11g Mode				Test channel: Lowest		
Peak value:						
Frequency (MHz)	Reading (dBuV)	Factor (dB/m)	Result (dBuV/m)	Limit Line (dBuV/m)	Over Limit (dB)	polarization
4824.00	28.08	15.31	43.39	74.00	-30.61	Vertical
7236.00	28.69	18.06	46.75	74.00	-27.25	Vertical
9648.00	29.76	23.77	53.53	74.00	-20.47	Vertical
12060.00	*			74.00		Vertical
14472.00	*			74.00		Vertical
4824.00	27.59	15.31	42.90	74.00	-31.10	Horizontal
7236.00	30.41	18.06	48.47	74.00	-25.53	Horizontal
9648.00	29.06	23.77	52.83	74.00	-21.17	Horizontal
12060.00	*			74.00		Horizontal
14472.00	*			74.00		Horizontal
Average value:						
Frequency (MHz)	Reading (dBuV)	Factor (dB/m)	Result (dBuV/m)	Limit Line (dBuV/m)	Over Limit (dB)	polarization
4824.00	19.16	15.31	34.47	54.00	-19.53	Vertical
7236.00	19.56	18.06	37.62	54.00	-16.38	Vertical
9648.00	20.11	23.77	43.88	54.00	-10.12	Vertical
12060.00	*			54.00		Vertical
14472.00	*			54.00		Vertical
4824.00	19.12	15.31	34.43	54.00	-19.57	Horizontal
7236.00	21.65	18.06	39.71	54.00	-14.29	Horizontal
9648.00	19.81	23.77	43.58	54.00	-10.42	Horizontal
12060.00	*			54.00		Horizontal
14472.00	*			54.00		Horizontal



Test Results (Above 1000MHz)

Test Mode: 802.11g Mode				Test channel: Middle		
Peak value:						
Frequency (MHz)	Reading (dBuV)	Factor (dB/m)	Result (dBuV/m)	Limit Line (dBuV/m)	Over Limit (dB)	polarization
4874.00	28.13	15.41	43.54	74.00	-30.46	Vertical
7311.00	28.75	18.01	46.76	74.00	-27.24	Vertical
9748.00	29.78	23.79	53.57	74.00	-20.43	Vertical
12185.00	*			74.00		Vertical
14622.00	*			74.00		Vertical
4874.00	28.44	15.41	43.85	74.00	-30.15	Horizontal
7311.00	30.03	18.01	48.04	74.00	-25.96	Horizontal
9748.00	29.38	23.79	53.17	74.00	-20.83	Horizontal
12185.00	*			74.00		Horizontal
14622.00	*			74.00		Horizontal
Average value:						
Frequency (MHz)	Reading (dBuV)	Factor (dB/m)	Result (dBuV/m)	Limit Line (dBuV/m)	Over Limit (dB)	polarization
4874.00	18.97	15.41	34.38	54.00	-19.62	Vertical
7311.00	20.07	18.01	38.08	54.00	-15.92	Vertical
9748.00	21.03	23.79	44.82	54.00	-9.18	Vertical
12185.00	*			54.00		Vertical
14622.00	*			54.00		Vertical
4874.00	20.55	15.41	35.96	54.00	-18.04	Horizontal
7311.00	21.12	18.01	39.13	54.00	-14.87	Horizontal
9748.00	19.10	23.79	42.89	54.00	-11.11	Horizontal
12185.00	*			54.00		Horizontal
14622.00	*			54.00		Horizontal



Test Results (Above 1000MHz)

Test Mode: 802.11g Mode				Test channel: Highest		
Peak value:						
Frequency (MHz)	Reading (dBuV)	Factor (dB/m)	Result (dBuV/m)	Limit Line (dBuV/m)	Over Limit (dB)	polarization
4924.00	28.69	15.51	44.20	74.00	-29.80	Vertical
7386.00	29.45	17.97	47.42	74.00	-26.58	Vertical
9848.00	30.59	23.82	54.41	74.00	-19.59	Vertical
12310.00	*			74.00		Vertical
14772.00	*			74.00		Vertical
4924.00	27.83	15.51	43.34	74.00	-30.66	Horizontal
7386.00	28.99	17.97	46.96	74.00	-27.04	Horizontal
9848.00	28.98	23.82	52.80	74.00	-21.20	Horizontal
12310.00	*			74.00		Horizontal
14772.00	*			74.00		Horizontal
Average value:						
Frequency (MHz)	Reading (dBuV)	Factor (dB/m)	Result (dBuV/m)	Limit Line (dBuV/m)	Over Limit (dB)	polarization
4924.00	18.60	15.51	34.11	54.00	-19.89	Vertical
7386.00	19.37	17.97	37.34	54.00	-16.66	Vertical
9848.00	20.59	23.82	44.41	54.00	-9.59	Vertical
12310.00	*			54.00		Vertical
14772.00	*			54.00		Vertical
4924.00	18.19	15.51	33.70	54.00	-20.30	Horizontal
7386.00	19.46	17.97	37.43	54.00	-16.57	Horizontal
9848.00	18.59	23.82	42.41	54.00	-11.59	Horizontal
12310.00	*			54.00		Horizontal
14772.00	*			54.00		Horizontal

Remark:

1. During the test, pre-scan the 802.11b,g,n(HT20) mode, and found the 802.11g mode is worse case , the report only record this mode.
2. Result=Reading + Factor
3. "*" means the test results were attenuated more than 20dB below the permissible limits, so the results don't record in the report.



Radiated Band Edge:

Test Mode: 802.11b Mode				Test channel: Lowest		
Peak value:						
Frequency (MHz)	Reading (dBuV)	Factor (dB/m)	Result (dBuV/m)	Limit Line (dBuV/m)	Over Limit (dB)	Polarization
2310.00	37.71	9.58	47.29	74.00	-26.71	Horizontal
2390.00	40.36	9.73	50.09	74.00	-23.91	Horizontal
2310.00	38.91	9.58	48.49	74.00	-25.51	Vertical
2390.00	45.90	9.73	55.63	74.00	-18.37	Vertical
Average value:						
Frequency (MHz)	Reading (dBuV)	Factor (dB/m)	Result (dBuV/m)	Limit Line (dBuV/m)	Over Limit (dB)	Polarization
2310.00	28.32	9.58	37.90	54.00	-16.10	Horizontal
2390.00	35.48	9.73	45.21	54.00	-8.79	Horizontal
2310.00	29.81	9.58	39.39	54.00	-14.61	Vertical
2390.00	37.79	9.73	47.52	54.00	-6.48	Vertical

Test Mode: 802.11b Mode				Test channel: Highest		
Peak value:						
Frequency (MHz)	Reading (dBuV)	Factor (dB/m)	Result (dBuV/m)	Limit Line (dBuV/m)	Over Limit (dB)	Polarization
2483.50	46.05	9.91	55.96	74.00	-18.04	Horizontal
2500.00	39.82	9.94	49.76	74.00	-24.24	Horizontal
2483.50	46.41	9.91	56.32	74.00	-17.68	Vertical
2500.00	39.43	9.94	49.37	74.00	-24.63	Vertical
Average value:						
Frequency (MHz)	Reading (dBuV)	Factor (dB/m)	Result (dBuV/m)	Limit Line (dBuV/m)	Over Limit (dB)	Polarization
2483.50	37.11	9.91	47.02	54.00	-6.98	Horizontal
2500.00	28.83	9.94	38.77	54.00	-15.23	Horizontal
2483.50	38.53	9.91	48.44	54.00	-5.56	Vertical
2500.00	29.37	9.94	39.31	54.00	-14.69	Vertical

Remark: 1. Result=Reading + Factor



Radiated Band Edge:

Test Mode: 802.11g Mode				Test channel: Lowest		
Peak value:						
Frequency (MHz)	Reading (dBuV)	Factor (dB/m)	Result (dBuV/m)	Limit Line (dBuV/m)	Over Limit (dB)	Polarization
2310.00	36.58	9.58	46.16	74.00	-27.84	Horizontal
2390.00	40.10	9.73	49.83	74.00	-24.17	Horizontal
2310.00	38.28	9.58	47.86	74.00	-26.14	Vertical
2390.00	41.83	9.73	51.56	74.00	-22.44	Vertical
Average value:						
Frequency (MHz)	Reading (dBuV)	Factor (dB/m)	Result (dBuV/m)	Limit Line (dBuV/m)	Over Limit (dB)	Polarization
2310.00	28.60	9.58	38.18	54.00	-15.82	Horizontal
2390.00	34.65	9.73	44.38	54.00	-9.62	Horizontal
2310.00	29.68	9.58	39.26	54.00	-14.74	Vertical
2390.00	35.58	9.73	45.31	54.00	-8.69	Vertical

Test Mode: 802.11g Mode				Test channel: Highest		
Peak value:						
Frequency (MHz)	Reading (dBuV)	Factor (dB/m)	Result (dBuV/m)	Limit Line (dBuV/m)	Over Limit (dB)	Polarization
2483.50	46.04	9.91	55.95	74.00	-18.05	Horizontal
2500.00	39.69	9.94	49.63	74.00	-24.37	Horizontal
2483.50	46.14	9.91	56.05	74.00	-17.95	Vertical
2500.00	39.33	9.94	49.27	74.00	-24.73	Vertical
Average value:						
Frequency (MHz)	Reading (dBuV)	Factor (dB/m)	Result (dBuV/m)	Limit Line (dBuV/m)	Over Limit (dB)	Polarization
2483.50	35.28	9.91	45.19	54.00	-8.81	Horizontal
2500.00	27.93	9.94	37.87	54.00	-16.13	Horizontal
2483.50	37.48	9.91	47.39	54.00	-6.61	Vertical
2500.00	28.90	9.94	38.84	54.00	-15.16	Vertical

Remark: 1. Result=Reading + Factor



Radiated Band Edge:

Test Mode: 802.11n (HT20) Mode				Test channel: Lowest		
Peak value:						
Frequency (MHz)	Reading (dBuV)	Factor (dB/m)	Result (dBuV/m)	Limit Line (dBuV/m)	Over Limit (dB)	Polarization
2310.00	34.58	9.58	44.16	74.00	-29.84	Horizontal
2390.00	38.10	9.73	47.83	74.00	-26.17	Horizontal
2310.00	37.28	9.58	46.86	74.00	-27.14	Vertical
2390.00	39.83	9.73	49.56	74.00	-24.44	Vertical
Average value:						
Frequency (MHz)	Reading (dBuV)	Factor (dB/m)	Result (dBuV/m)	Limit Line (dBuV/m)	Over Limit (dB)	Polarization
2310.00	27.28	9.58	36.86	54.00	-17.14	Horizontal
2390.00	32.57	9.73	42.30	54.00	-11.70	Horizontal
2310.00	27.29	9.58	36.87	54.00	-17.13	Vertical
2390.00	33.58	9.73	43.31	54.00	-10.69	Vertical

Test Mode: 802.11n (HT20) Mode				Test channel: Highest		
Peak value:						
Frequency (MHz)	Reading (dBuV)	Factor (dB/m)	Result (dBuV/m)	Limit Line (dBuV/m)	Over Limit (dB)	Polarization
2483.50	43.82	9.91	53.73	74.00	-20.27	Horizontal
2500.00	37.82	9.94	47.76	74.00	-26.24	Horizontal
2483.50	45.41	9.91	55.32	74.00	-18.68	Vertical
2500.00	39.43	9.94	49.37	74.00	-24.63	Vertical
Average value:						
Frequency (MHz)	Reading (dBuV)	Factor (dB/m)	Result (dBuV/m)	Limit Line (dBuV/m)	Over Limit (dB)	Polarization
2483.50	33.26	9.91	43.17	54.00	-10.83	Horizontal
2500.00	28.08	9.94	38.02	54.00	-15.98	Horizontal
2483.50	34.30	9.91	44.21	54.00	-9.79	Vertical
2500.00	29.04	9.94	38.98	54.00	-15.02	Vertical

Remark: 1. Result=Reading + Factor



5. Maximum Peak Output Power Test

5.1. Test Standard and Limit

Test Standard	FCC Part15 C Section 15.247 (b)(3)
Test Limit	1W (30dBm)

5.2. Test Setup

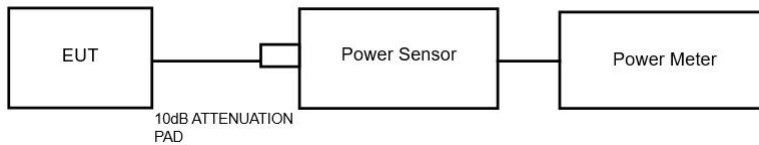

5.3. Test Procedure

1. The Transmitter output (antenna port) was connected to the power meter.
2. Turn on the EUT and power meter and then record the power value.
3. Repeat above procedures on all channels needed to be tested.

Note: The cable loss and attenuator loss were offset into measure device as amplitude offset.

5.4. Test Data

Pass

Please refer to Appendix C of the Appendix Test Data.

Additional test for duty cycle.

Please refer to Appendix G of the Appendix Test Data.



6. 6dB Occupy Bandwidth Test

6.1. Test Standard and Limit

Test Standard	FCC Part15 C Section 15.247 (a)(2)
Test Limit	≥500kHz

6.2. Test Setup

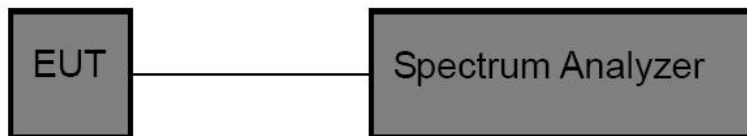

6.3. Test Procedure

1. Place the EUT on the table and set it in the transmitting mode.
2. Remove the antenna from the EUT and then connect a low loss RF cable from the antenna port to the spectrum analyzer.
3. Set the spectrum analyzer as:
 - RBW= 100kHz, VBW≥3*RBW
 - Detector= Peak
 - Trace mode= Max hold.
 - Sweep- auto couple.
4. Mark the peak frequency and -6dB (upper and lower) frequency.
5. Repeat until all the rest channels are investigated.

6.4. Test Data

Pass

Please refer to Appendix A of the Appendix Test Data.



7. Power Spectral Density Test

7.1. Test Standard and Limit

Test Standard	FCC Part15 C Section15.247 (e)
Test Limit	8dBm/3KHz

7.2. Test Setup

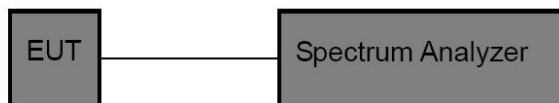

7.3. Test Procedure

1. Place the EUT on the table and set it in transmitting mode. Remove the antenna from the EUT and then connect a low loss RF cable from the antenna port to the spectrum analyzer.
2. Set the spectrum analyzer as RBW = 3kHz, VBW = 10kHz, Span = 1.5xDTS BW
3. Record the max. reading.
4. Repeat the above procedure until the measurements for all frequencies are completed.

7.4. Test Data

Pass

Please refer to Appendix D of the Appendix Test Data.



8. 100kHz Bandwidth of Frequency Band Edge Requirement

8.1. Test Standard and Limit

Test Standard	FCC Part15 C Section 15.247 (d)
Test Limit	In any 100 kHz bandwidth outside the frequency bands in which the spread spectrum intentional radiator is operating, the radio frequency power that is produced by the intentional radiator shall be at least 20dB below that in the 100kHz bandwidth within the band that contains the highest level of the desired power, In addition, radiated emissions which fall in the restricted bands, as defined in §15.205(a), must also comply with the radiated emission limits specified in 15.209(a).

8.2. Test Setup

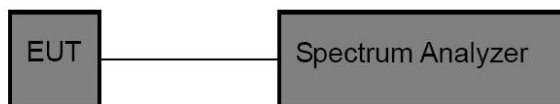

8.3. Test Procedure

Using the following spectrum analyzer setting:

1. Set the RBW = 100kHz.
2. Set the VBW = 300kHz.
3. Sweep time = auto couple.
4. Detector function = peak.
5. Trace mode = max hold.
6. Allow trace to fully stabilize.

8.4. Test Data

Pass

Please refer to Appendix E & Appendix F of the Appendix Test Data.



9. Antenna Requirement

9.1. Test Standard and Requirement

Test Standard	FCC Part15 Section 15.203 /247(c)
Requirement	<p>1) 15.203 requirement: An intentional radiator shall be designed to ensure that no antenna other than that furnished by the responsible party shall be used with the device. The use of a permanently attached antenna or of an antenna that uses a unique coupling to the intentional radiator, the manufacturer may design the unit so that a broken antenna can be replaced by the user, but the use of a standard antenna jack or electrical connector is prohibited.</p> <p>2) 15.247(c) (1)(i) requirement: Systems operating in the 2400-2483.5 MHz band that is used exclusively for fixed. Point-to-point operations may employ transmitting antennas with directional gain greater than 6dBi provided the maximum conducted output power of the intentional radiator is reduced by 1 dB for every 3 dB that the directional gain of the antenna exceeds 6 dBi.</p>

9.2. Antenna Connected Construction

The antenna is a PCB Antenna which permanently attached, and the best case gain of the antenna is 3.85dBi It complies with the standard requirement.



APPENDIX I -- TEST SETUP PHOTOGRAPH

Please refer to separated files Appendix I -- Test Setup Photograph

APPENDIX II -- EXTERNAL PHOTOGRAPH

Please refer to separated files Appendix II -- External Photograph

APPENDIX III -- INTERNAL PHOTOGRAPH

Please refer to separated files Appendix III -- Internal Photograph

----- End of Report -----

