

FCC/ISED Test Report

Report No.: RWAZ202300024A

Applicant: Shenzhen Qianyan Technology LTD

Address: No.3301, Block C, Section 1, Chuangzhi Yuncheng Building,
Liuxian Avenue, Xili Community, Xili Street, Nanshan District,
Shenzhen, China

Product Name: Govee RGBIC Outdoor Neon Rope Light

Product Model: H61A9

Multiple Models: N/A

Trade Mark: Govee

FCC ID: 2A7VD-H61A9

IC: 28789-H61A9

Standards: FCC CFR Title 47 Part 15C (§15.247)
RSS-247 Issue 2, February 2017

Test Date: 2023-12-07 to 2023-12-18

Test Result: Complied

Report Date: 2023-12-29

Reviewed by:

Frank Yin

Approved by:

Jacob Kong

Frank Yin

Project Engineer

Jacob Kong

Manager

Prepared by:

World Alliance Testing and Certification (Shenzhen) Co., Ltd

No. 1002, East Block, Laobing Building, Xingye Road 3012, Xixiang street, Bao'an District, Shenzhen,
Guangdong, People's Republic of China



This report may contain data that are not covered by the NVLAP accreditation and shall be marked with an asterisk “★”

Announcement

1. This test report shall not be reproduced in full or partial, without the written approval of World Alliance Testing and Certification (Shenzhen) Co., Ltd
2. The results in this report apply only to the sample tested.
3. This sample tested is in compliance with the limits of the above regulation.
4. This report must not be used by the client to claim product certification, approval, or endorsement by NVLAP, NIST, or any agency of the U.S. Government.
5. The information marked “#” is provided by the applicant, the laboratory is not responsible for its authenticity and this information can affect the validity of the result in the test report. Customer model name, addresses, names, trademarks etc. are included.

Revision History

Version No.	Issued Date	Description
00	2023-12-29	Original

Contents

1	General Information	4
1.1	Client Information	4
1.2	Product Description of EUT	4
1.3	Antenna information	4
1.4	Related Submittal(s)/Grant(s).....	5
1.5	Measurement Uncertainty	5
1.6	Laboratory Location.....	6
1.7	Test Methodology	6
2	Description of Measurement.....	7
2.1	Test Configuration.....	7
2.2	Test Auxiliary Equipment	8
2.3	Test Setup.....	8
2.4	Test Procedure	10
2.5	Measurement Method.....	11
2.6	Measurement Equipment	12
3	Test Results	13
3.1	Test Summary.....	13
3.2	Limit	14
3.3	AC Line Conducted Emissions Test Data.....	15
3.4	Radiated emission Test Data.....	17
3.5	RF Conducted Test Data	25
3.5.1	6 dB Emission Bandwidth and 99% Occupied Bandwidth.....	25
3.5.2	Maximum Conducted Peak Output Power.....	25
3.5.3	Power Spectral Density.....	26
3.5.4	100 kHz Bandwidth of Frequency Band Edge	26
3.5.5	Duty Cycle	26
4	Test Setup Photo.....	35
5	E.U.T Photo.....	36

1 General Information

1.1 Client Information

Applicant:	Shenzhen Qianyan Technology LTD
Address:	No.3301, Block C, Section 1, Chuangzhi Yuncheng Building, Liuxian Avenue, Xili Community, Xili Street, Nanshan District, Shenzhen, China
Manufacturer:	Shenzhen Qianyan Technology LTD
Address:	No.3301, Block C, Section 1, Chuangzhi Yuncheng Building, Liuxian Avenue, Xili Community, Xili Street, Nanshan District, Shenzhen, China

1.2 Product Description of EUT

The EUT is Govee RGBIC Outdoor Neon Rope Light that contains 2.4G WLAN and BLE radios, this report covers the full testing of the 2.4G WLAN radio.

HVIN	H61A9
Sample Serial Number	F-3 for CE test, F-5 for RE test, F-1 for RF test conducted test (assigned by WATC)
Sample Received Date	2023-12-07
Sample Status	Good Condition
Frequency Range	2412MHz - 2472MHz(802.11b, g, n-HT20)
Maximum Conducted Peak Output Power	12.75dBm
Modulation Technology	DSSS, OFDM
Antenna Gain [#]	3.85dBi
Spatial Streams [#]	SISO (1TX, 1RX)
Power Supply	DC 36.0V/3.0A from adapter
Adapter Information	Model: SOY-3600300US-306A Input: AC100-240V, 50/60Hz, 1.8A Output: DC 36.0V/3.0A
Modification	Sample No Modification by the test lab

1.3 Antenna information

15.203 requirement:

An intentional radiator shall be designed to ensure that no antenna other than that furnished by the responsible party shall be used with the device. The use of a permanently attached antenna or of an antenna that uses a unique coupling to the intentional radiator, the manufacturer may design the unit so that a broken antenna can be replaced by the user, but the use of a standard antenna jack or electrical connector is prohibited.

RSS-GEN Clause 6.8 requirement:

The applicant for equipment certification shall provide a list of all antenna types that may be used with the transmitter, where applicable (i.e. for transmitters with detachable antenna), indicating the maximum permissible antenna gain (in dBi) and the required impedance for each antenna. The test report shall demonstrate the compliance of the transmitter with the limit for maximum equivalent isotropically radiated power (e.i.r.p.) specified in the applicable RSS, when the transmitter is equipped with any antenna type, selected from this list.

For expediting the testing, measurements may be performed using only the antenna with highest gain of each combination of transmitter and antenna type, with the transmitter output power set at the maximum level. However, the transmitter shall comply with the applicable requirements under all operational conditions and when in combination with any type of antenna from the list provided in the test report (and in the notice to be included in the user manual, provided below).

When measurements at the antenna port are used to determine the RF output power, the effective gain of the device's antenna shall be stated, based on a measurement or on data from the antenna's manufacturer. The test report shall state the RF power, output power setting and spurious emission measurements with each antenna type that is used with the transmitter being tested.

Immediately following the above notice, the manufacturer shall provide a list of all antenna types which can be used with the transmitter, indicating the maximum permissible antenna gain (in dBi) and the required impedance for each antenna type.

Device Antenna information:

The Wi-Fi antenna is an internal antenna which cannot replace by end-user. Please see product internal photos for details.

Antenna type	Antenna gain	Frequency Range	Input impedance
PCB antenna	3.85dBi	2.4-2.5GHz	50Ω

1.4 Related Submittal(s)/Grant(s)

No Related Submittal(s)/Grant(s)

1.5 Measurement Uncertainty

Parameter	Expanded Uncertainty (Confidence of 95%(U = 2Uc(y)))	
AC Power Lines Conducted Emissions	±3.14dB	
Emissions, Radiated	Below 30MHz	±2.78dB
	Below 1GHz	±4.84dB
	Above 1GHz	±5.44dB
Emissions, Conducted	1.75dB	
Conducted Power	0.74dB	
Frequency Error	150Hz	
Bandwidth	0.34%	
Power Spectral Density	0.74dB	

Note 1: The extended uncertainty given in this report is obtained by combining the standard uncertainty times the coverage factor K with the 95% confidence interval. Otherwise required by the applicant or Product Regulations, Decision Rule in this report did not consider the uncertainty.

Note 2: The Decision Rule is based on simple acceptance with ISO Guide 98-4:2012 Clause 8.2 (Measurement uncertainty is not taken into account when stating conformity with a specified requirement.)

1.6 Laboratory Location

World Alliance Testing and Certification (Shenzhen) Co., Ltd

No. 1002, East Block, Laobing Building, Xingye Road 3012, Xixiang street, Bao'an District, Shenzhen, Guangdong, People's Republic of China

Tel: +86-755-29691511, Email: qa@watc.com.cn

The lab has been recognized as the FCC accredited lab under the KDB 974614 D01 and is listed in the FCC Public Access Link (PAL) database, FCC Registration No. : 463912, the FCC Designation No. : CN5040.

The lab has been recognized by Innovation, Science and Economic Development Canada to test to Canadian radio equipment requirements, the CAB identifier: CN0160.

1.7 Test Methodology

FCC CFR 47 Part 2

FCC CFR 47 Part 15

KDB 558074 D01 DTS Meas Guidance v05r02

ANSI C63.10-2020

RSS-247 Issue 2, February 2017

RSS-Gen, Issue 5, Amendment 2 (February 2021)

2 Description of Measurement

2.1 Test Configuration

Operating channels:					
Channel No.	Frequency (MHz)	Channel No.	Frequency (MHz)	Channel No.	Frequency (MHz)
1	2412	6	2437	11	2462
2	2417	7	2442	12	2467
3	2422	8	2447	13	2472
4	2427	9	2452	/	/
5	2432	10	2457	/	/

According to ANSI C63.10-2020 chapter 5.6.1 Table 11 requirement, select lowest channel, middle channel, and highest channel in the frequency range in which device operates for testing. The detailed frequency points are as follows:

802.11b, 802.11g, 802.11n-HT20					
Lowest channel		Middle channel		Highest channel	
Channel No.	Frequency (MHz)	Channel No.	Frequency (MHz)	Channel No.	Frequency (MHz)
1	2412	7	2442	13	2472

802.11n-HT40					
Lowest channel		Middle channel		Highest channel	
Channel No.	Frequency (MHz)	Channel No.	Frequency (MHz)	Channel No.	Frequency (MHz)
3	2422	7	2442	11	2462

Test Mode:				
Transmitting mode:	Keep the EUT in continuous transmitting with modulation			
Exercise software [#] :	mptool			
Mode	Worst-case Data rate	Power Level Setting [#]		
		Low Channel	Middle Channel	High Channel
802.11b	1Mbps	44	44	44
802.11g	6Mbps	40	40	40
802.11n-HT20	6.5Mbps	32	32	32

The exercise software and the maximum power setting that provided by manufacturer.

Worst-Case Configuration:
For radiated emissions, EUT was investigated in three orthogonal orientation, the worst-case orientation was recorded in report
For AC power line conducted emission and radiated emission 9kHz-1GHz and above 18GHz were performed with the EUT transmits at the channel with highest output power as worst-case scenario.

2.2 Test Auxiliary Equipment

Manufacturer	Description	Model	Serial Number
/	/	/	/

2.3 Test Setup

1) Conducted emission measurement:

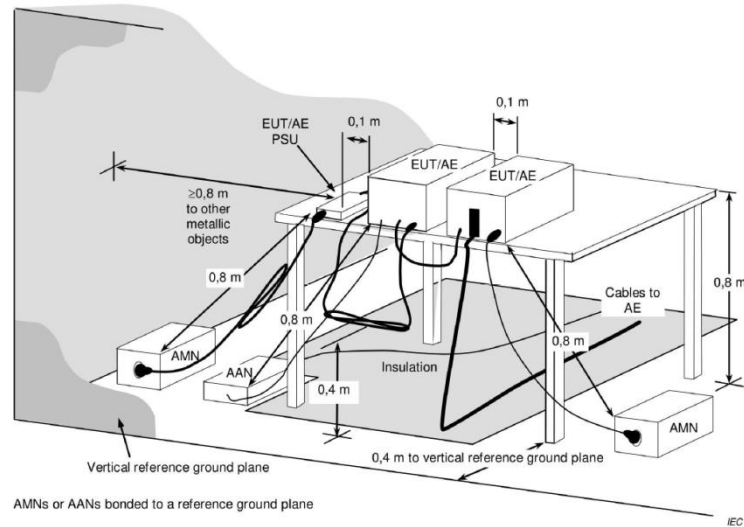

Note: The 0.8 m distance specified between EUT/AE/PSU and AMN/AAN, is applicable only to the EUT being measured. If the device is AE then it shall be >0.8 m.

2) Radiated emission measurement:

Below 30MHz (3m SAC)

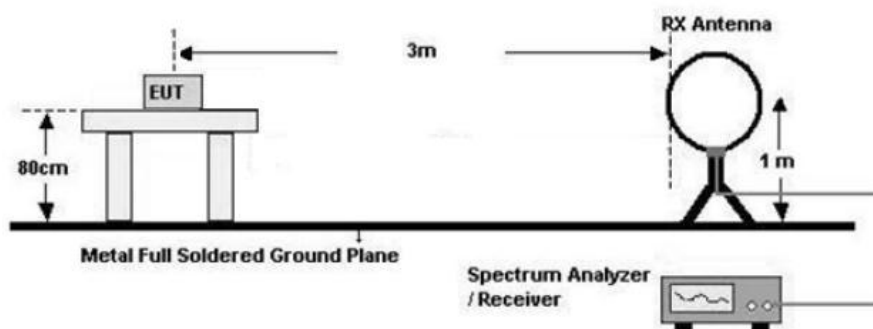

30MHz-1GHz (3m SAC)

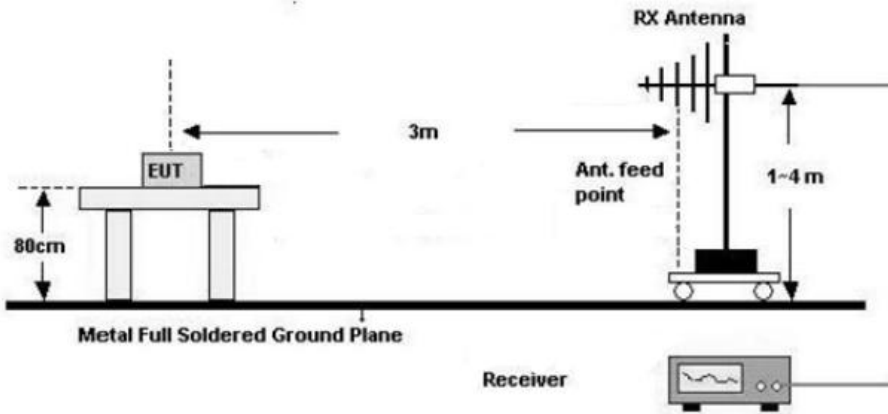

1GHz-18GHz(3m FAC)

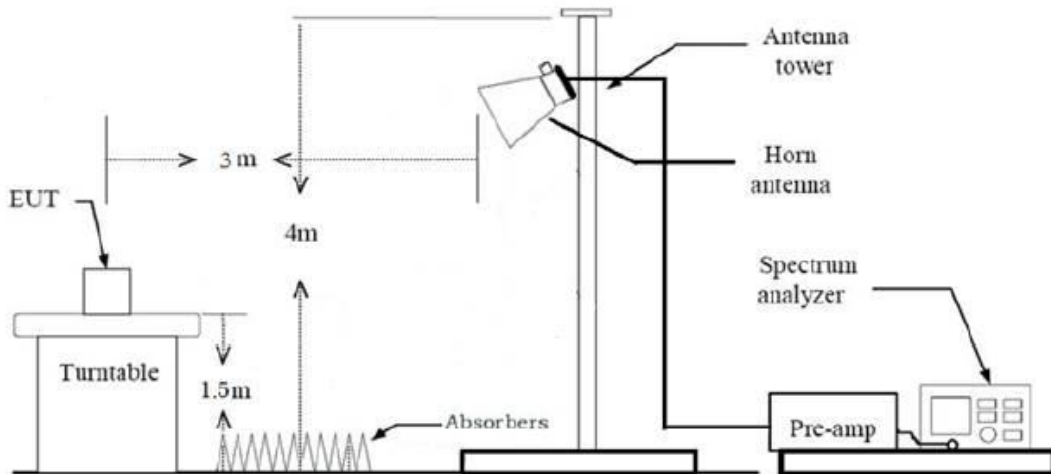

Above 18GHz (3m FAC)

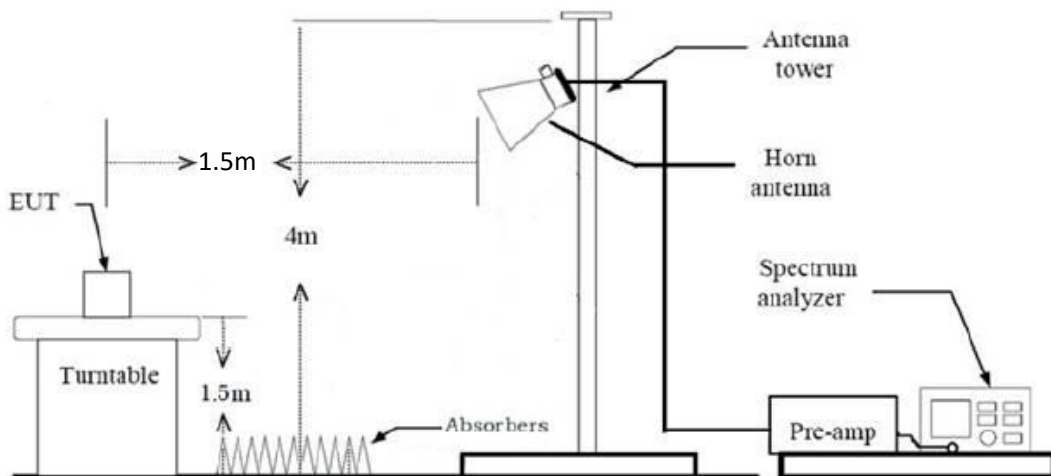

3) RF Conducted Test

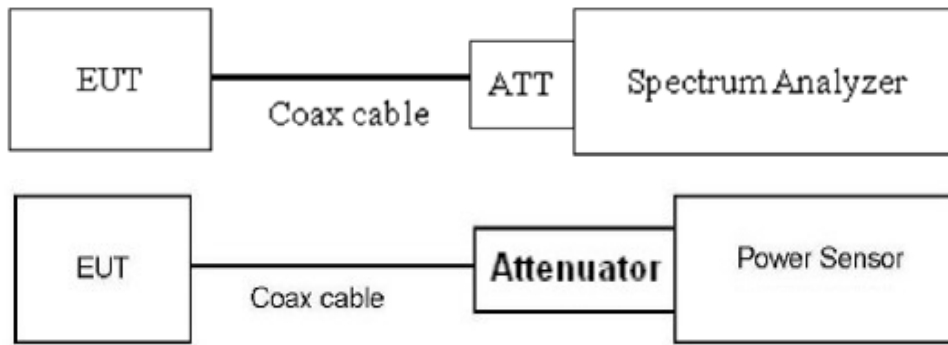

2.4 Test Procedure

Conducted emission:

1. The E.U.T is placed on a non-conducting table 40cm from the vertical ground plane and 80cm above the horizontal ground plane (Please refer to the block diagram of the test setup and photographs).
2. Both sides of A.C. line are checked for maximum conducted interference. In order to find the maximum emission, the relative positions of equipment and all of the interface cables must be changed according to ANSI C63.10 on conducted measurement.
3. Line conducted data is recorded for both Line and Neutral

Radiated Emission Procedure:

a) For below 30MHz

1. All measurements were made at a test distance of 3 m. The measured data was extrapolated from the test distance (3m) to the specification distance (300 m from 9-490 kHz and 30 m from 490 kHz- 30 MHz) to clearly show the relative levels of fundamental and spurious emissions and demonstrate compliance with the requirement that the level of any spurious emissions be below the level of the intentionally transmitted signal. The extrapolation factor for the limits were $40 \cdot \log(\text{test distance} / \text{specification distance})$.
2. Loop antenna use, investigation was done on the three antenna orientations (parallel, perpendicular, ground-parallel)

b) For 30MHz-1GHz:

1. The EUT was placed on the tabletop of a rotating table 0.8 m the ground at a 3 m semi anechoic chamber. The measurement distance from the EUT to the receiving antenna is 3 m.
2. EUT works in each mode of operation that needs to be tested. The highest signal levels relative to the limit shall be determined by rotating the EUT from 0° to 360° and with varying the measurement antenna height between 1 m and 4 m in vertical and horizontal polarizations.

c) For above 1GHz:

1. The EUT was placed on the tabletop of a rotating table 1.5 m the ground at a 3 m fully anechoic room. The measurement distance from the EUT to the receiving antenna is 3 m (1-18GHz) and 1.5 m (above 18GHz).

2. EUT works in each mode of operation that needs to be tested, and having the EUT continuously working. The highest signal levels relative to the limit shall be determined by rotating the EUT from 0° to 360° and with varying the measurement antenna height between 1 m and 4 m in vertical and horizontal polarizations.
3. Open the test software to control the test antenna and test turntable. Perform the test, save the test results, and export the test data.
4. Base on FCC 15.31 (f) (2): measurements may be performed at a distance closer than that specified in the regulations; however, an attempt should be made to avoid making measurements in the near field.

RF Conducted Test:

1. The antenna port of EUT was connected to the RF port of the test equipment (Power Meter or Spectrum analyzer) through Attenuator and RF cable.
2. The cable assembly insertion loss of 7.0dB (including 6.0 dB Attenuator and 1.0 dB cable) was entered as an offset in the power meter. Note: Actual cable loss was unavailable at the time of testing, therefore a loss of 1.0dB was assumed as worst case. This was later verified to be true by laboratory. (if the RF cable provided by client, the cable loss declared by client)
3. The EUT is keeping in continuous transmission mode and tested in all modulation modes.

2.5 Measurement Method

Description of Test	Measurement Method
AC Line Conducted Emissions	ANSI C63.10-2020 Section 6.2
Maximum Conducted Output Power	ANSI C63.10-2020 Section 11.9.1.2 PKPM1 Peak power meter method or ANSI C63.10-2020 Section 11.9.2.3.2 Method AVGPM-G
Power Spectral Density	ANSI C63.10-2020 Section 11.10.2 Method PKPSD (peak PSD)
6 dB Emission Bandwidth	ANSI C63.10-2020 Section 11.8.1
99% Occupied Bandwidth	ANSI C63.10-2020 Section 6.9.3
100kHz Bandwidth of Frequency Band Edge	ANSI C63.10-2020 Section 6.10
Radiated emission	ANSI C63.10-2020 Section 11.11&11.12
Duty Cycle	ANSI C63.10-2020 Section 11.6

2.6 Measurement Equipment

Manufacturer	Description	Model	Management No.	Calibration Date	Calibration Due Date
AC Line Conducted Emission Test					
ROHDE& SCHWARZ	EMI TEST RECEIVER	ESR	101817	2023/7/3	2024/7/2
R&S	LISN	ENV216	101748	2023/7/3	2024/7/2
N/A	Coaxial Cable	NO.12	N/A	2023/7/3	2024/7/2
Farad	Test Software	EZ-EMC	Ver. EMEC-3A1	/	/
Radiated Emission Test					
R&S	EMI test receiver	ESR3	102758	2023/7/3	2024/7/2
ROHDE& SCHWARZ	SPECTRUM ANALYZER	FSV40-N	101608	2023/7/3	2024/7/2
SONOMA INSTRUMENT	Low frequency amplifier	310	186014	2023/7/12	2024/7/11
COM-POWER	preamplifier	PAM-118A	18040152	2023/8/21	2024/8/20
COM-POWER	Amplifier	PAM-840A	461306	2023/8/8	2024/8/7
ETS	Passive Loop Antenna	6512	29604	2023/7/7	2024/7/6
SCHWARZBECK	Log - periodic wideband antenna	VULB 9163	9163-872	2023/7/7	2024/7/6
Astro Antenna Ltd	Horn antenna	AHA-118S	3015	2023/7/6	2024/7/5
Ducommun technologies	Horn Antenna	ARH-4223-02	1007726-03	2023/7/10	2024/7/9
Oulitong	Band Reject Filter	OBSF-2400-248 3.5-50N	OE02103119	2023/9/15	2024/9/14
N/A	Coaxial Cable	N/A	NO.9	2023/8/8	2024/8/7
N/A	Coaxial Cable	N/A	NO.10	2023/8/8	2024/8/7
N/A	Coaxial Cable	N/A	NO.11	2023/8/8	2024/8/7
Audix	Test Software	E3	191218 V9	/	/
RF Conducted Test					
ROHDE& SCHWARZ	SPECTRUM ANALYZER	FSU-26	200680/026	2023/7/12	2024/7/11
ANRITSU	USB Power Sensor	MA24418A	12620	2023/7/12	2024/7/11
narda	6dB attenuator	603-06-1	N/A	2023/7/26	2024/7/25

Note: All equipment is calibrated with valid calibrations. Each measurement data is traceable to the national or International standards.

3 Test Results

3.1 Test Summary

FCC/ISED Rules	Description of Test	Result
§15.203 RSS-GEN §6.8	Antenna Requirement	Compliance
§15.207 (a) RSS-GEN §8.8	AC Line Conducted Emissions	Compliance
§15.247(b)(3) RSS-247 §5.4 d)	Maximum Conducted Output Power	Compliance
§15.247(e) RSS-247 §5.2 b)	Power Spectral Density	Compliance
§15.247 (a)(2) RSS-247 §5.2 a)	6 dB Emission Bandwidth	Compliance
RSS-GEN §6.7	99% Occupied Bandwidth	Report only
§15.247(d) RSS-247 §5.5	100kHz Bandwidth of Frequency Band Edge	Compliance
§15.205, §15.209, §15.247(d) RSS-247 §5.5 RSS-GEN §8.9&§8.10	Radiated emission	Compliance
-	Duty Cycle	Report only

3.2 Limit

Test items	Limit
AC Line Conducted Emissions	See details §15.207 (a)/ RSS-GEN §8.8
Conducted Output Power	<p>For systems using digital modulation in the 902-928 MHz, 2400-2483.5 MHz, and 5725-5850 MHz bands: 1 Watt.</p> <p>The e.i.r.p. shall not exceed 4 W, except as provided in section 5.4(e).</p>
6dB Emission Bandwidth	The minimum 6 dB bandwidth shall be at least 500 kHz.
Power Spectral Density	For digitally modulated systems, the power spectral density conducted from the intentional radiator to the antenna shall not be greater than 8 dBm in any 3 kHz band during any time interval of continuous transmission.
Spurious Emissions, 100kHz Bandwidth of Frequency Band Edge	<p>In any 100 kHz bandwidth outside the frequency band in which the spread spectrum or digitally modulated intentional radiator is operating, the radio frequency power that is produced by the intentional radiator shall be at least 20 dB below that in the 100 kHz bandwidth within the band that contains the highest level of the desired power, based on either an RF conducted or a radiated measurement, provided the transmitter demonstrates compliance with the peak conducted power limits. If the transmitter complies with the conducted power limits based on the use of RMS averaging over a time interval, as permitted under paragraph (b)(3) of this section, the attenuation required under this paragraph shall be 30 dB instead of 20 dB. Attenuation below the general limits specified in §15.209(a)/RSS-GEN §8.9 is not required. In addition, radiated emissions which fall in the restricted bands, as defined in §15.205(a) /RSS-GEN §8.10, must also comply with the radiated emission limits specified in §15.209(a) /RSS-GEN §8.9 (see §15.205(c)).</p>

3.3 AC Line Conducted Emissions Test Data

Test Date:	2023-12-11	Test By:	Lirou Li
Environment condition:	Temperature: 27°C; Relative Humidity:70%; ATM Pressure: 100.6kPa		

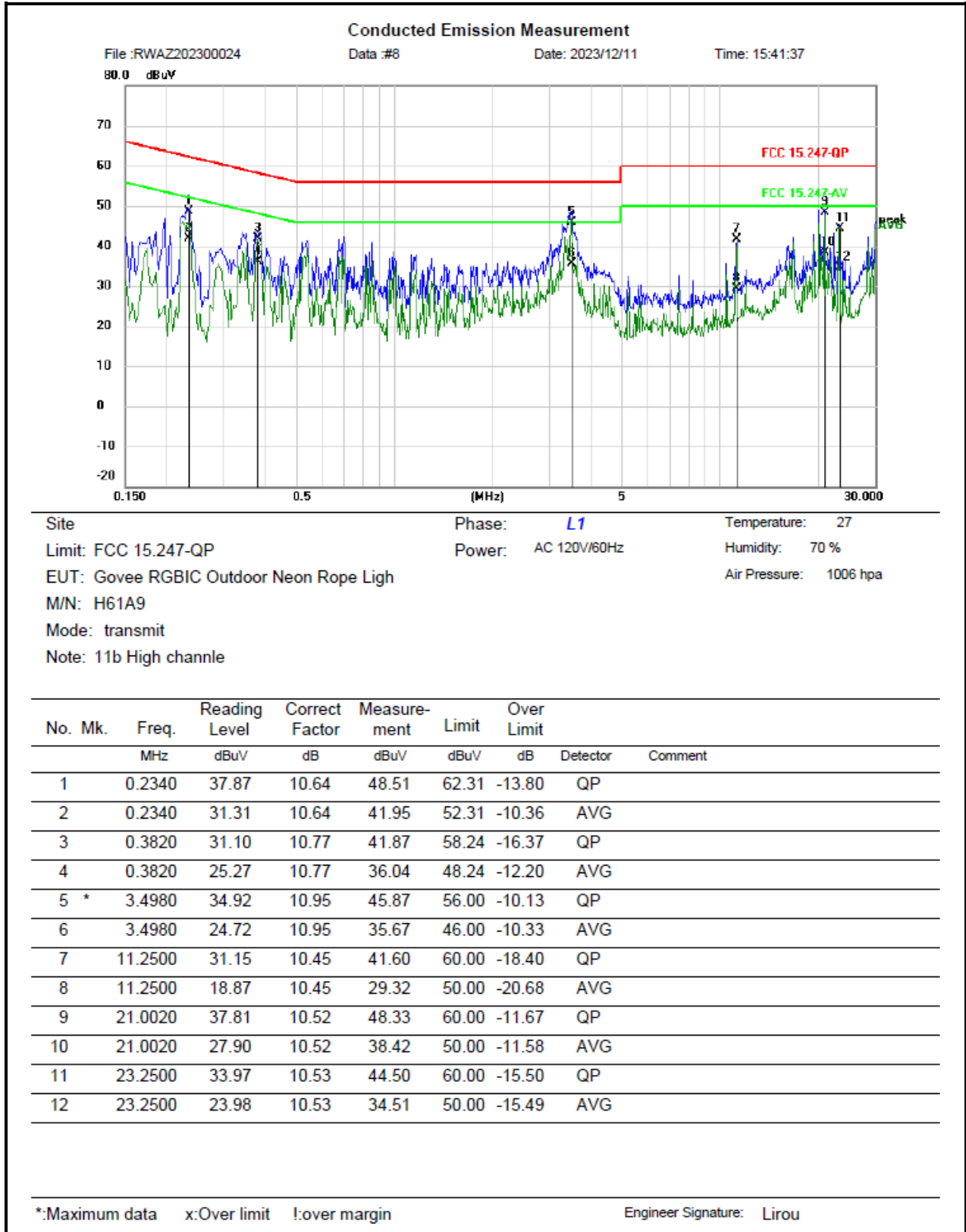

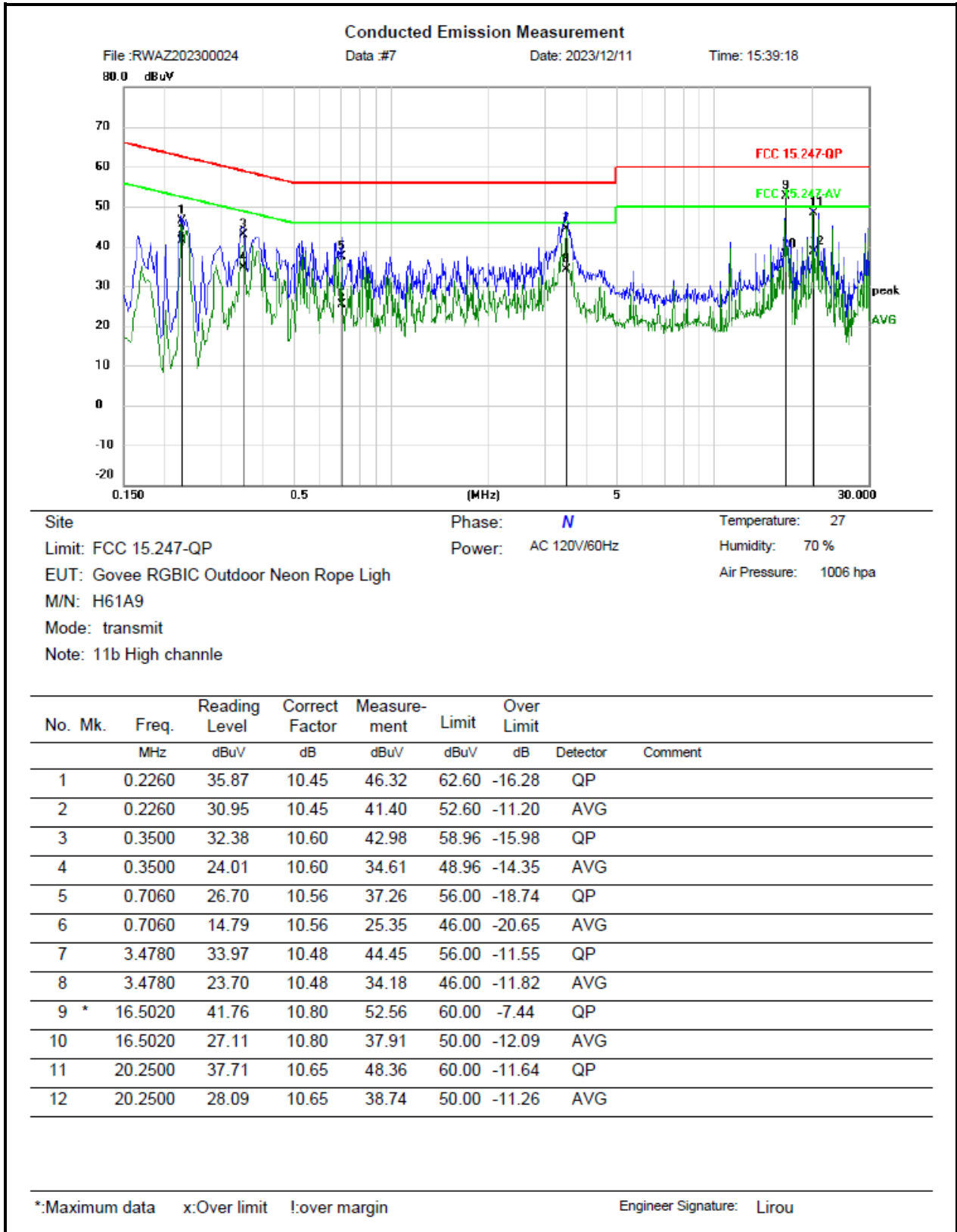

Remark:

Measurement (dBuV)= Reading Level (dBuV) + Correct Factor(dB)

Correct Factor (dB)= LISN Voltage Division Factor (dB)+ Cable loss(dB)

Over Limit= Measurement – Limit

3.4 Radiated emission Test Data

9 kHz-30MHz:

Test Date:	2023-12-07	Test By:	Bard Huang
Environment condition:	Temperature: 24°C; Relative Humidity:44%; ATM Pressure: 101kPa		

For radiated emissions below 30MHz, there were no emissions found within 20dB of limit.

30MHz-1GHz:

Test Date:	2023-12-07	Test By:	Bard Huang
Environment condition:	Temperature: 24°C; Relative Humidity:44%; ATM Pressure: 101kPa		

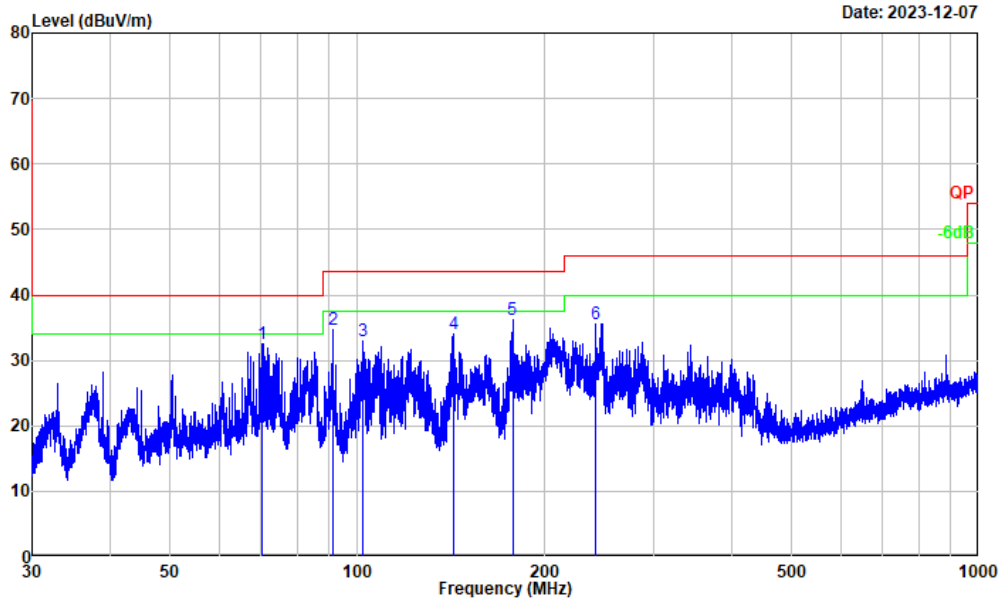

Project No. : RWAZ202300024
 EUT/Model No.: H61A9
 Test Mode : Transmitting
 Test Voltage : AC 120V/60Hz
 Environment : 24°C/44%R.H./101kPa
 Tested by : Bard Huang
 Polarization : horizontal
 Remark : 802.11b High Channel

--No.	Frequency (MHz)	Reading (dBμV)	Factor (dB/m)	Result (dBμV/m)	Limit (dBμV/m)	Over Limit (dB)	Detector
1	70.491	48.76	-16.26	32.50	40.00	-7.50	Peak
2	91.495	49.93	-15.14	34.79	43.50	-8.71	Peak
3	102.001	46.69	-13.79	32.90	43.50	-10.60	Peak
4	142.699	51.50	-17.36	34.14	43.50	-9.36	Peak
5	177.821	51.77	-15.62	36.15	43.50	-7.35	Peak
6	242.207	48.05	-12.42	35.63	46.00	-10.37	Peak

Remarks: Factor = Antenna factor + Cable loss - Preamp gain

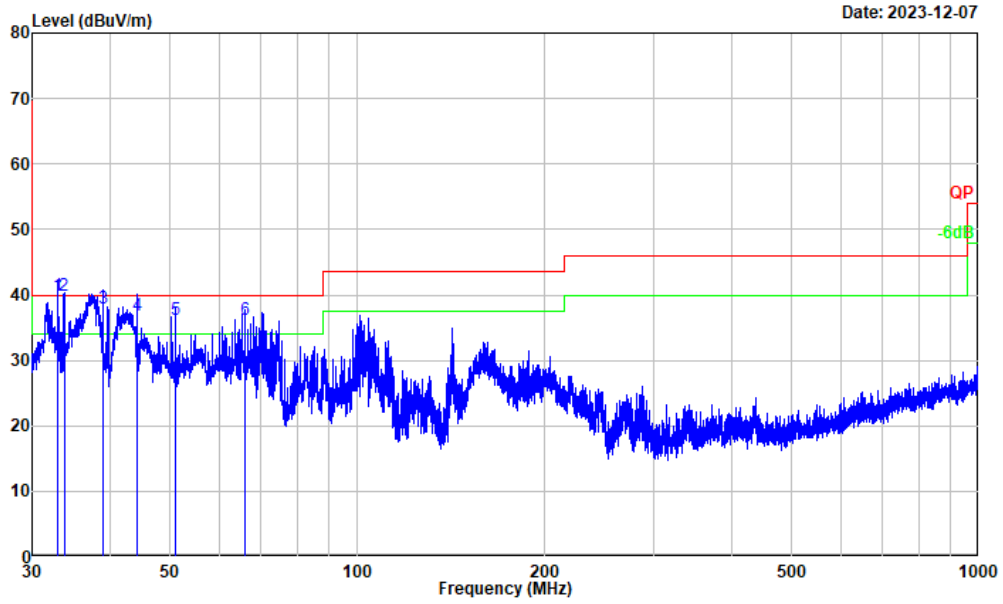

Project No. : RWAZ202300024
 EUT/Model No.: H61A9
 Test Mode : Transmitting
 Test Voltage : AC 120V/60Hz
 Environment : 24°C/44%R.H./101kPa
 Tested by : Bard Huang
 Polarization : vertical
 Remark : 802.11b High Channel

--No.	Frequency (MHz)	Reading (dBμV)	Factor (dB/m)	Result (dBμV/m)	Limit (dBμV/m)	Over Limit (dB)	Detector
1	33.008	54.90	-14.95	39.95	40.00	-0.05	QP
2	33.769	54.70	-14.89	39.81	40.00	-0.19	QP
3	38.990	51.20	-13.19	38.01	40.00	-1.99	QP
4	44.236	49.01	-12.05	36.96	40.00	-3.04	QP
5	50.987	48.10	-11.95	36.15	40.00	-3.85	QP
6	65.976	50.50	-14.34	36.16	40.00	-3.84	QP

Remarks: Factor = Antenna factor + Cable loss - Preamp gain

Remark:

$Level = Reading + Factor$

$Factor = Antenna\ factor + Cable\ loss - Amplifier\ gain$

$Over\ Limit = Level - Limit$

Above 1GHz:

Test Date:	2023-12-13~2023-12-18	Test By:	Bard Huang
Environment condition:	Temperature: 23.0°C; Relative Humidity: 60%; ATM Pressure: 100.7kPa		

Frequency (MHz)	Reading level (dB μ V)	Polar	Corrected Factor (dB/m)	Corrected Amplitude (dB μ V/m)	Limit (dB μ V/m)	Margin (dB)	Remark
802.11b							
Low Channel							
2390.000	37.74	horizontal	8.25	45.99	54.00	-8.01	Average
2390.000	48.76	horizontal	8.25	57.01	74.00	-16.99	Peak
2390.000	37.50	vertical	8.25	45.75	54.00	-8.25	Average
2390.000	49.78	vertical	8.25	58.03	74.00	-15.97	Peak
4824.000	42.19	horizontal	0.26	42.45	54	-11.55	Average
4824.000	47.63	horizontal	0.26	47.89	74	-26.11	Peak
4824.000	43.84	vertical	0.26	44.1	54	-9.9	Average
4824.000	48.96	vertical	0.26	49.22	74	-24.78	Peak
Middle Channel							
4884.000	42.54	horizontal	0.46	43	54	-11	Average
4884.000	48.35	horizontal	0.46	48.81	74	-25.19	Peak
4884.000	43.49	vertical	0.46	43.95	54	-10.05	Average
4884.000	48.86	vertical	0.46	49.32	74	-24.68	Peak
High Channel							
2483.500	37.54	horizontal	8.25	45.79	54.00	-8.21	Average
2483.500	52.42	horizontal	8.25	60.67	74.00	-13.33	Peak
2483.500	37.34	vertical	8.25	45.59	54.00	-8.41	Average
2483.500	48.82	vertical	8.25	57.07	74.00	-16.93	Peak
4944.000	45.12	horizontal	0.83	45.95	54.00	-8.05	Average
4944.000	50.72	horizontal	0.83	51.55	74.00	-22.45	Peak
4944.000	46.06	vertical	0.83	46.89	54.00	-7.11	Average
4944.000	51.06	vertical	0.83	51.89	74.00	-22.11	Peak
802.11g							
Low Channel							
2390.000	37.48	horizontal	8.25	45.73	54.00	-8.27	Average
2390.000	48.64	horizontal	8.25	56.89	74.00	-17.11	Peak

2390.000	37.48	vertical	8.25	45.73	54.00	-8.27	Average
2390.000	50.07	vertical	8.25	58.32	74.00	-15.68	Peak
4824.000	37.84	horizontal	0.26	38.10	54.00	-15.90	Average
4824.000	48.50	horizontal	0.26	48.76	74.00	-25.24	Peak
4824.000	38.56	vertical	0.26	38.82	54.00	-15.18	Average
4824.000	49.21	vertical	0.26	49.47	74.00	-24.53	Peak
Middle Channel							
4884.000	37.45	horizontal	0.46	37.91	54.00	-16.09	Average
4884.000	48.12	horizontal	0.46	48.58	74.00	-25.42	Peak
4884.000	37.89	vertical	0.46	38.35	54.00	-15.65	Average
4884.000	48.58	vertical	0.46	49.04	74.00	-24.96	Peak
High Channel							
2483.500	40.13	horizontal	8.25	48.38	54.00	-5.62	Average
2483.500	63.31	horizontal	8.25	71.56	74.00	-2.44	Peak
2483.500	38.41	vertical	8.25	46.66	54.00	-7.34	Average
2483.500	56.76	vertical	8.25	65.01	74.00	-8.99	Peak
4944.000	37.11	horizontal	0.83	37.94	54.00	-16.06	Average
4944.000	48.20	horizontal	0.83	49.03	74.00	-24.97	Peak
4944.000	37.88	vertical	0.83	38.71	54.00	-15.29	Average
4944.000	48.24	vertical	0.83	49.07	74.00	-24.93	Peak
802.11n20							
Low Channel							
2390.000	37.58	horizontal	8.25	45.83	54.00	-8.17	Average
2390.000	48.74	horizontal	8.25	56.99	74.00	-17.01	Peak
2390.000	37.48	vertical	8.25	45.73	54.00	-8.27	Average
2390.000	48.75	vertical	8.25	57.00	74.00	-17.00	Peak
4824.000	37.59	horizontal	0.26	37.85	54.00	-16.15	Average
4824.000	48.62	horizontal	0.26	48.88	74.00	-25.12	Peak
4824.000	37.69	vertical	0.26	37.95	54.00	-16.05	Average
4824.000	48.00	vertical	0.26	48.26	74.00	-25.74	Peak
Middle Channel							
4884.000	36.24	horizontal	0.46	36.70	54.00	-17.30	Average
4884.000	48.16	horizontal	0.46	48.62	74.00	-25.38	Peak
4884.000	36.91	vertical	0.46	37.37	54.00	-16.63	Average
4884.000	47.91	vertical	0.46	48.37	74.00	-25.63	Peak
High Channel							
2483.500	40.76	horizontal	8.25	49.01	54.00	-4.99	Average
2483.500	63.21	horizontal	8.25	71.46	74.00	-2.54	Peak

2483.500	38.19	vertical	8.25	46.44	54.00	-7.56	Average
2483.500	55.31	vertical	8.25	63.56	74.00	-10.44	Peak
4944.000	36.79	horizontal	0.83	37.62	54.00	-16.38	Average
4944.000	47.64	horizontal	0.83	48.47	74.00	-25.53	Peak
4944.000	37.30	vertical	0.83	38.13	54.00	-15.87	Average
4944.000	48.27	vertical	0.83	49.10	74.00	-24.90	Peak

Remark:

Corrected Amplitude= Reading level + corrected Factor

Corrected Factor = Antenna factor + Cable loss – Amplifier gain

Margin = Corrected Amplitude – Limit

The emission levels of other frequencies that were lower than the limit 20dB not show in test report.

For emissions in 18GHz-25GHz range, all emissions were investigated and in the noise floor level.

Test plot for example as below:

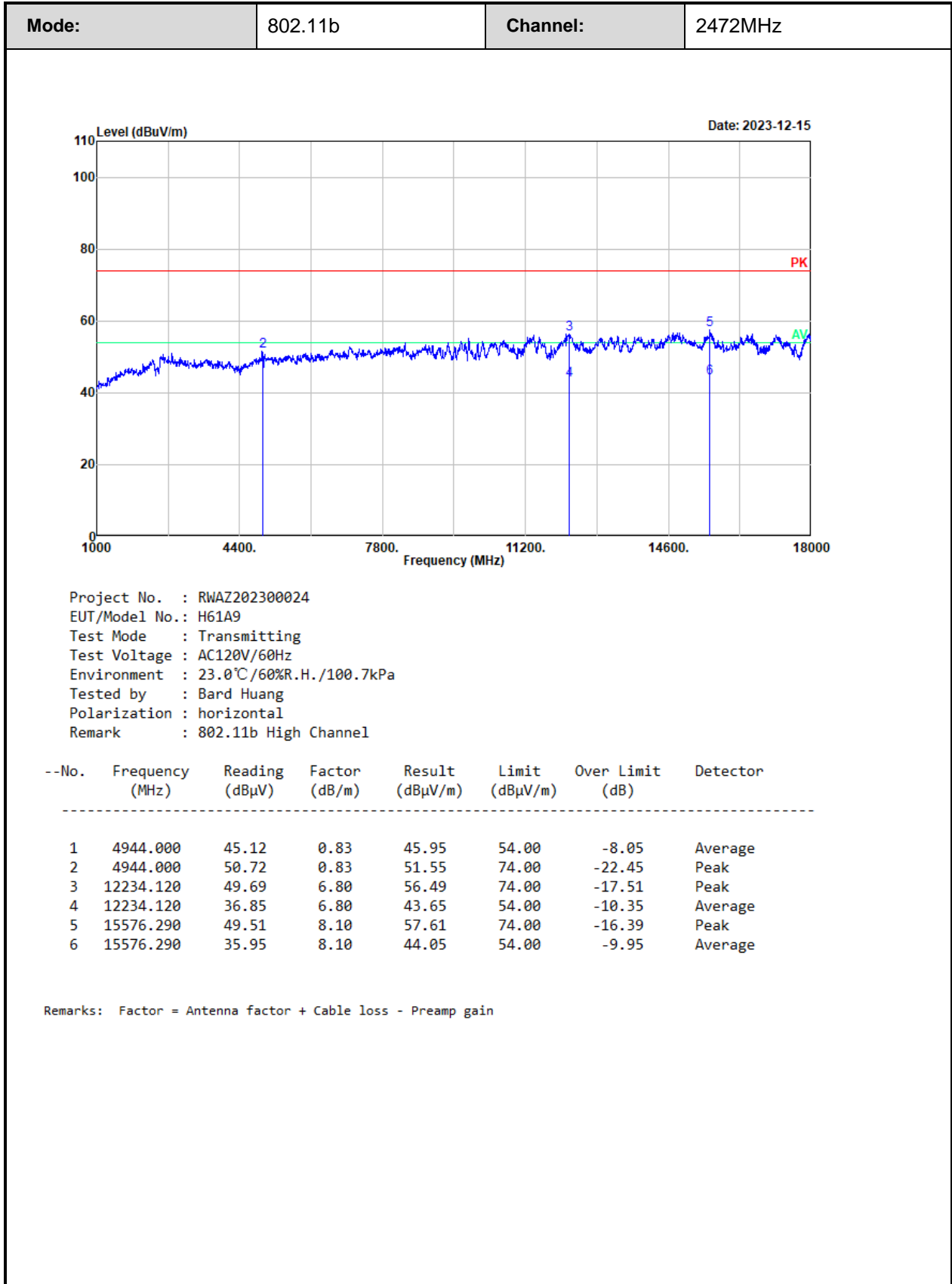

Mode:	802.11b	Channel:	2472MHz
--------------	---------	-----------------	---------

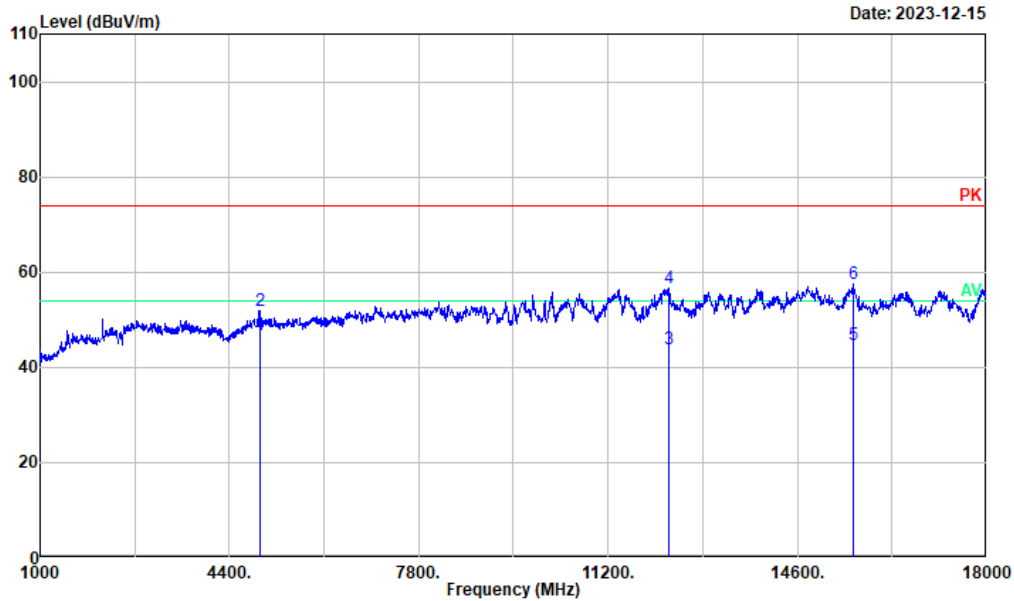

Project No. : RWAZ202300024
 EUT/Model No.: H61A9
 Test Mode : Transmitting
 Test Voltage : AC120V/60Hz
 Environment : 23.0°C/60%R.H./100.7kPa
 Tested by : Bard Huang
 Polarization : vertical
 Remark : 802.11b High Channel

--No.	Frequency (MHz)	Reading (dBμV)	Factor (dB/m)	Result (dBμV/m)	Limit (dBμV/m)	Over Limit (dB)	Detector
1	4944.000	46.06	0.83	46.89	54.00	-7.11	Average
2	4944.000	51.06	0.83	51.89	74.00	-22.11	Peak
3	12285.140	36.79	7.13	43.92	54.00	-10.08	Average
4	12285.140	49.58	7.13	56.71	74.00	-17.29	Peak
5	15601.800	36.69	8.09	44.78	54.00	-9.22	Average
6	15601.800	49.35	8.09	57.44	74.00	-16.56	Peak

Remarks: Factor = Antenna factor + Cable loss - Preamp gain

3.5 RF Conducted Test Data

Test Date:	2023-12-08	Test By:	Baylor Li
Environment condition:	Temperature: 23.8~24.6°C; Relative Humidity: 54~67%; ATM Pressure: 101~103kPa		

3.5.1 6 dB Emission Bandwidth and 99% Occupied Bandwidth

Test Mode	Antenna	Channel[MHz]	6dB BW [MHz]	99% OBW[MHz]	6dB BW Limit[MHz]	Verdict
11B	Ant1	2412	7.962	13.846	0.5	pass
		2442	7.974	13.910	0.5	pass
		2472	7.949	13.910	0.5	pass
11G	Ant1	2412	16.705	16.667	0.5	pass
		2442	16.513	16.667	0.5	pass
		2472	16.577	16.667	0.5	pass
11N20MIMO	Ant1	2412	17.756	17.756	0.5	pass
		2442	17.821	17.821	0.5	pass
		2472	17.756	17.821	0.5	pass

3.5.2 Maximum Conducted Peak Output Power

Test Mode	Antenna	Channel [MHz]	Result [dBm]	Limit [dBm]	Verdict
11B MIMO	Ant1	2412	12.22	30	Pass
		2442	12.46	30	Pass
		2472	12.75	30	Pass
11G MIMO	Ant1	2412	10.01	30	Pass
		2442	10.45	30	Pass
		2472	10.83	30	Pass
11N20 MIMO	Ant1	2412	7.76	30	Pass
		2442	8.18	30	Pass
		2472	8.53	30	Pass

3.5.3 Power Spectral Density

Test Mode	Antenna	Channel [MHz]	Result [dBm/3kHz]	Limit [dBm/3kHz]	Verdict
11B MIMO	Ant1	2412	-16.99	8	Pass
		2442	-16.61	8	Pass
		2472	-16.31	8	Pass
11G MIMO	Ant1	2412	-24.93	8	Pass
		2442	-24.65	8	Pass
		2472	-24.88	8	Pass
11N20 MIMO	Ant1	2412	-27.15	8	Pass
		2442	-26.85	8	Pass
		2472	-26.60	8	Pass

3.5.4 100 kHz Bandwidth of Frequency Band Edge

Test Mode	Antenna	Channel[MHz]	Result	Limit	Verdict
11B MIMO	Ant1	2412	Refer test plot	Refer test plot	Pass
		2472	Refer test plot	Refer test plot	Pass
11G MIMO	Ant1	2412	Refer test plot	Refer test plot	Pass
		2472	Refer test plot	Refer test plot	Pass
11N20 MIMO	Ant1	2412	Refer test plot	Refer test plot	Pass
		2472	Refer test plot	Refer test plot	Pass

3.5.5 Duty Cycle

Test Mode	Antenna	Channel[MHz]	Ton (ms)	Ton+off (ms)	Duty Cycle [%]	1/T	VBW setting* [Hz]
11B	Ant1	2442	20	20	100	/	10
11G	Ant1	2442	20	20	100	/	10
11N20	Ant1	2442	20	20	100	/	10

Note*: Radiated emission test with average value, the Spectrum analyzer VBW setting information.

Test Plots:

6 dB Emission Bandwidth:

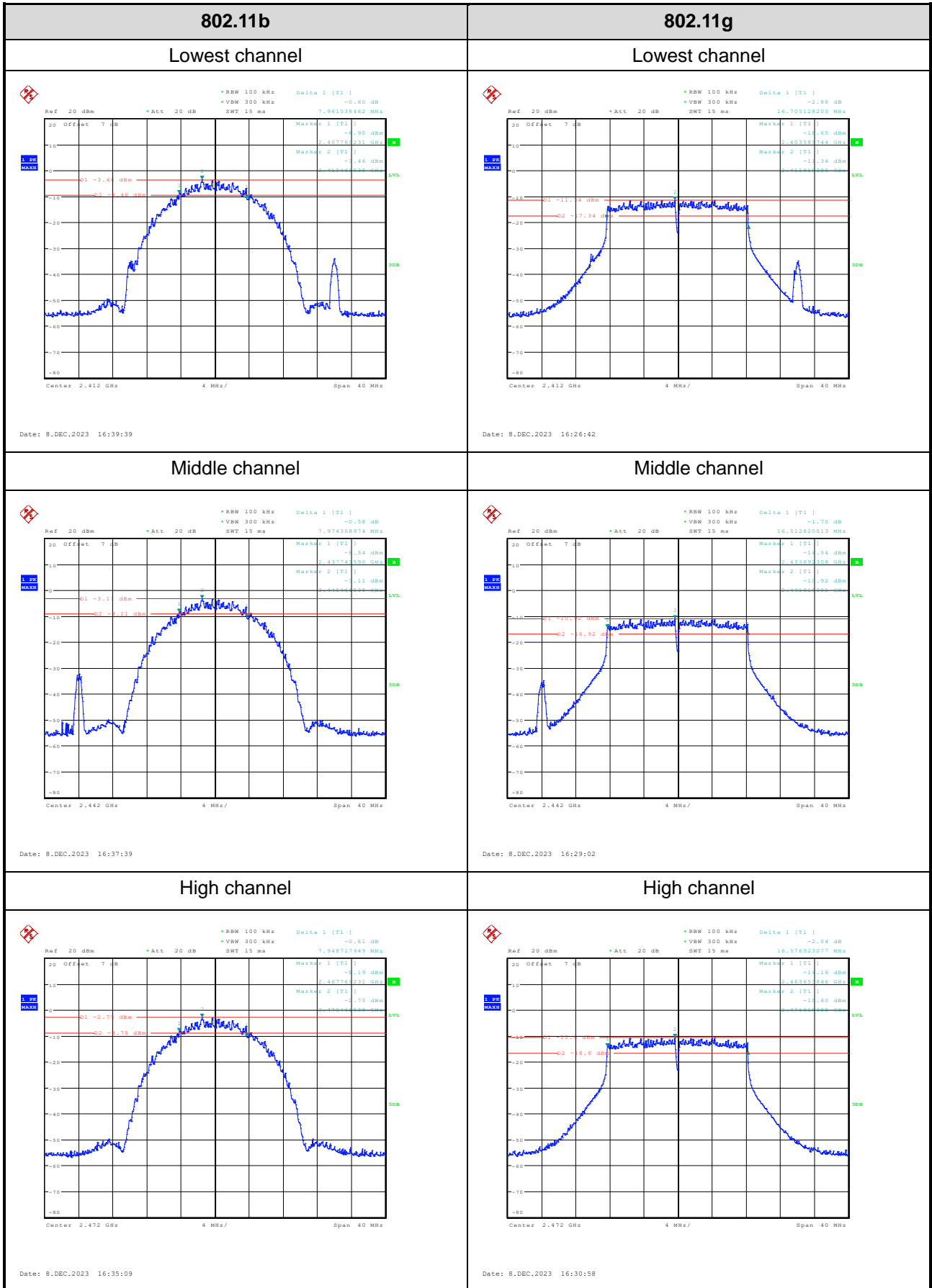

<p style="text-align: center;">802.11n20</p>	<p style="text-align: center;">/</p>
<p style="text-align: center;">Lowest channel</p>	<p style="text-align: center;">/</p>
<p>Date: 8.DEC.2023 16:24:09</p>	<p style="text-align: center;">/</p>
<p style="text-align: center;">Middle channel</p>	<p style="text-align: center;">/</p>
<p>Date: 8.DEC.2023 16:22:18</p>	<p style="text-align: center;">/</p>
<p style="text-align: center;">High channel</p>	<p style="text-align: center;">/</p>
<p>Date: 8.DEC.2023 16:20:25</p>	<p style="text-align: center;">/</p>

99% Occupied Bandwidth:

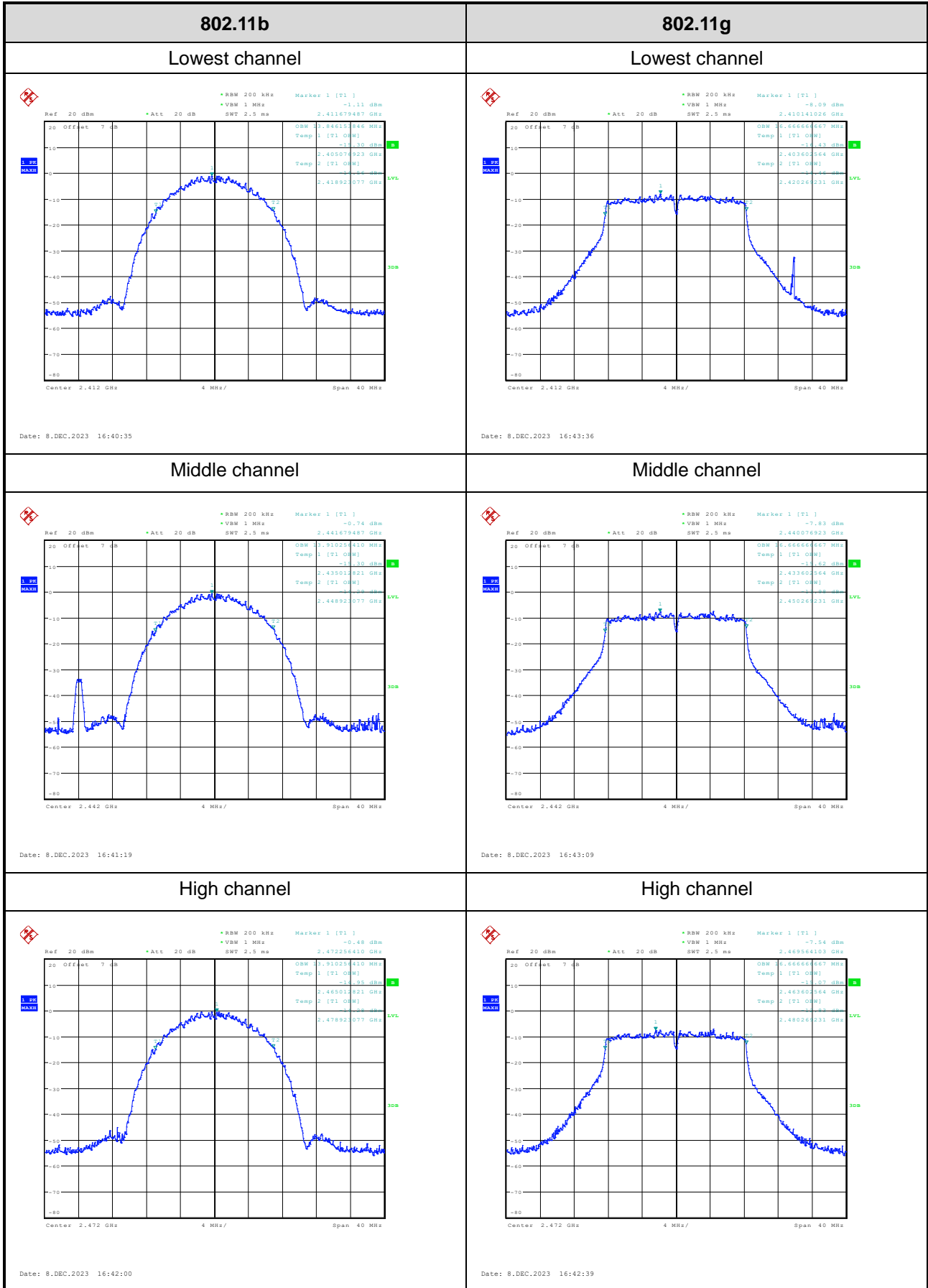

<p align="center">802.11n20</p>	<p align="center">/</p>
<p align="center">Lowest channel</p>	<p align="center">/</p>
<p>Date: 8.DEC.2023 16:44:52</p>	<p align="center">/</p>
<p align="center">Middle channel</p>	<p align="center">/</p>
<p>Date: 8.DEC.2023 16:50:08</p>	<p align="center">/</p>
<p align="center">High channel</p>	<p align="center">/</p>
<p>Date: 8.DEC.2023 16:51:00</p>	<p align="center">/</p>

Power Spectral Density:

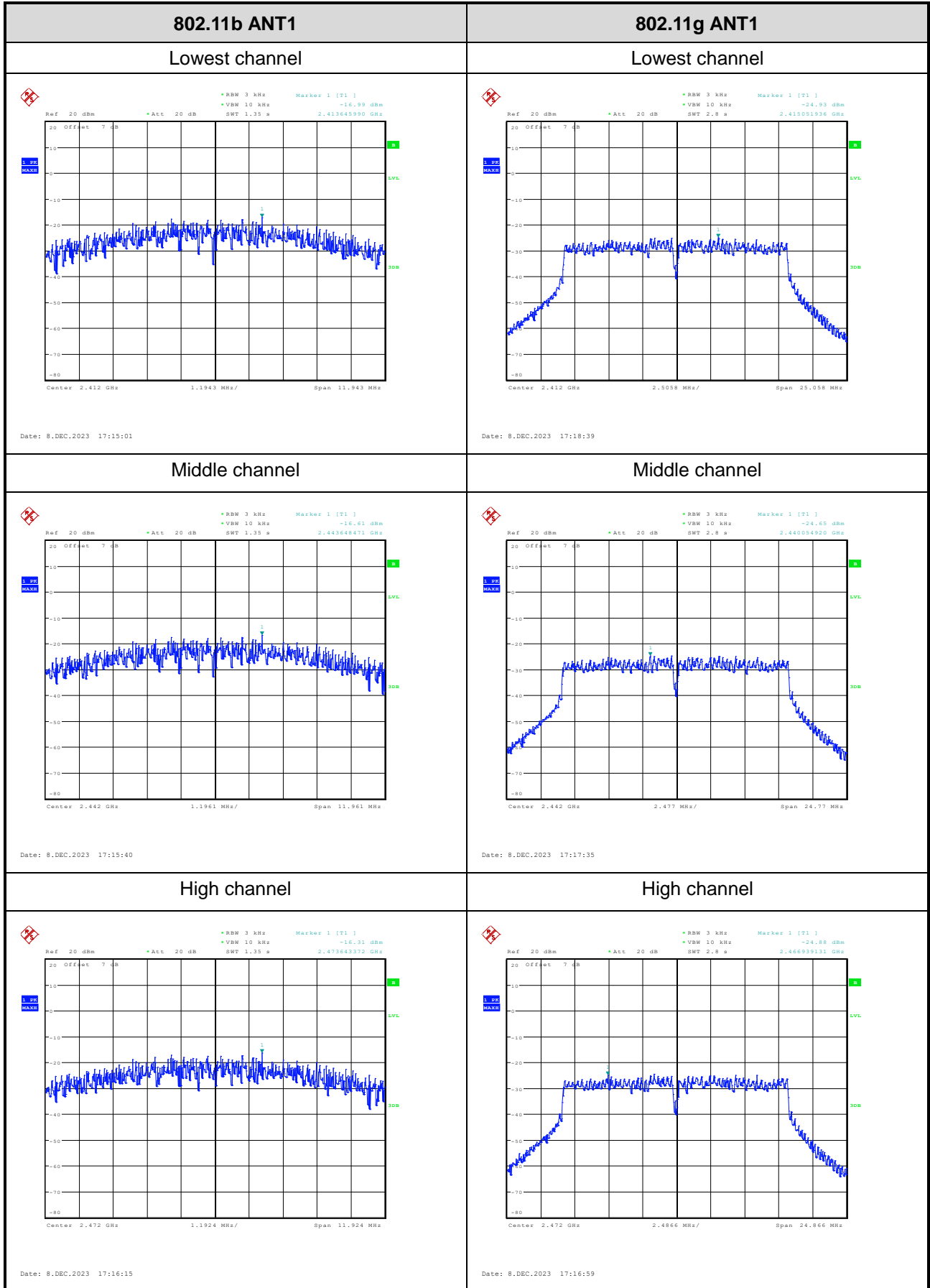

<p align="center">802.11n20 ANT1</p>	<p align="center">/</p>
<p align="center">Lowest channel</p>	<p align="center">/</p>
<p>Ref: 20 dBm *Att: 20 dB *RBW 3 kHz *VSW 10 kHz *SWT 3 s Marker 1 [T1] -27.15 dBm 2.410335375 GHz</p> <p>Center: 2.412 GHz 2.6634 MHz/ Span: 26.634 MHz</p> <p>Date: 8.DEC.2023 17:22:07</p>	<p align="center">/</p>
<p align="center">Middle channel</p>	<p align="center">/</p>
<p>Ref: 20 dBm *Att: 20 dB *RBW 3 kHz *VSW 10 kHz *SWT 3 s Marker 1 [T1] -26.85 dBm 2.440320950 GHz</p> <p>Center: 2.442 GHz 2.6732 MHz/ Span: 26.732 MHz</p> <p>Date: 8.DEC.2023 17:20:24</p>	<p align="center">/</p>
<p align="center">High channel</p>	<p align="center">/</p>
<p>Ref: 20 dBm *Att: 20 dB *RBW 3 kHz *VSW 10 kHz *SWT 3 s Marker 1 [T1] -26.60 dBm 2.470335375 GHz</p> <p>Center: 2.472 GHz 2.6634 MHz/ Span: 26.634 MHz</p> <p>Date: 8.DEC.2023 17:21:34</p>	<p align="center">/</p>

100kHz Bandwidth of Frequency Band Edge:

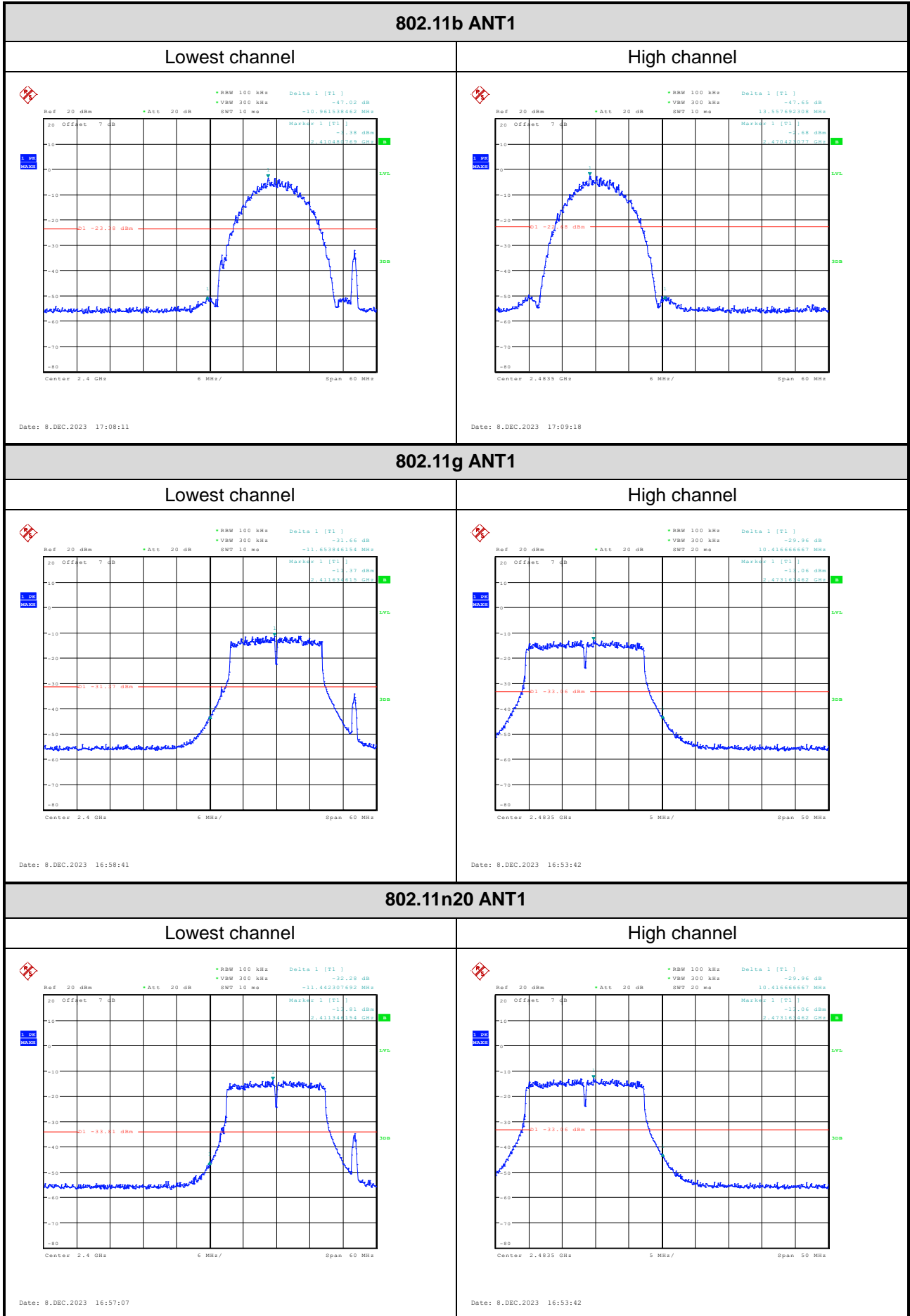

Duty Cycle:

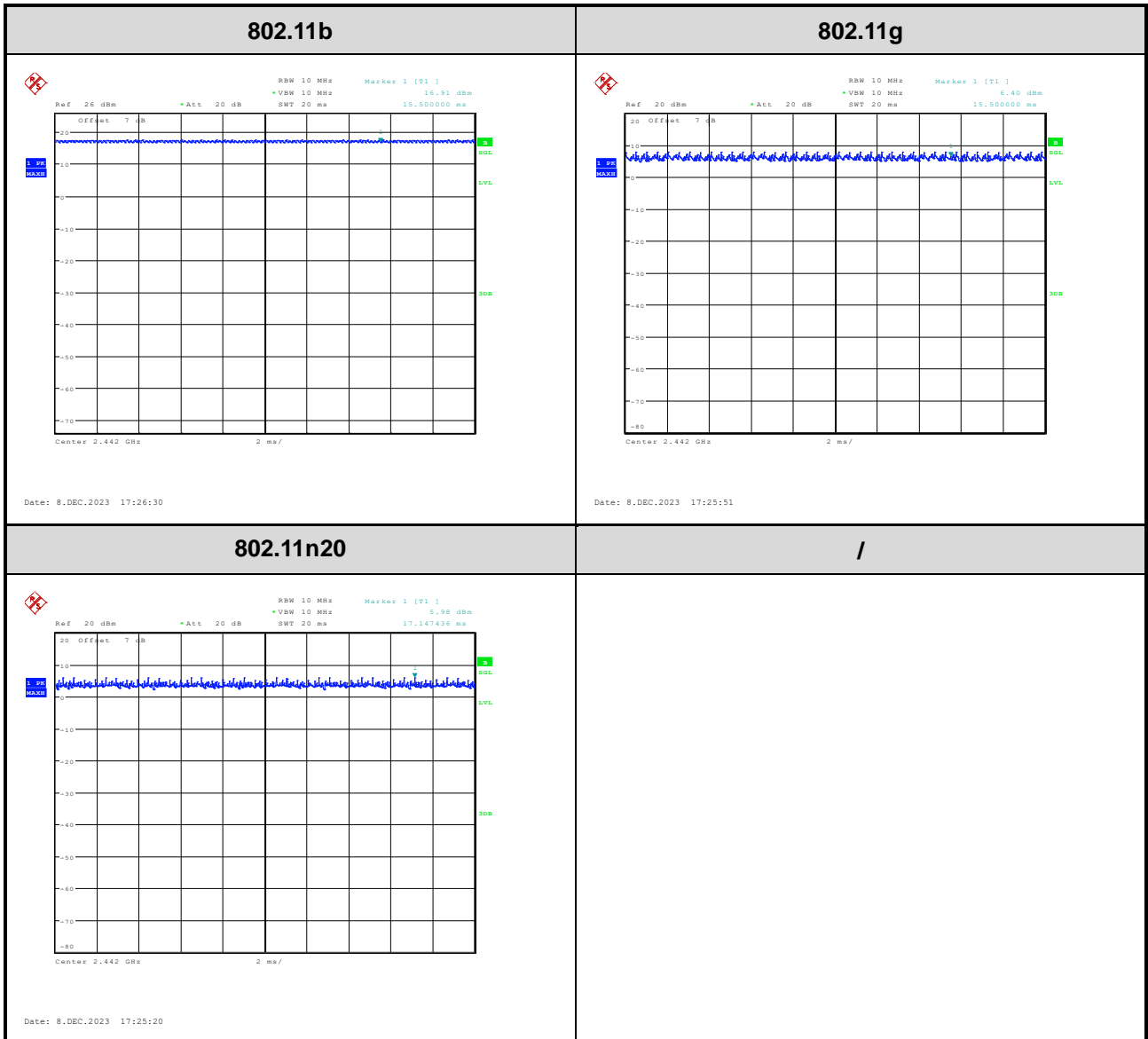

4 Test Setup Photo

Please refer to the attachment RWAZ202300024 Test Setup photo.

5 E.U.T Photo

Please refer to the attachment RWAZ202300024 External photo and RWAZ202300024 Internal photo.

---End of Report---