

FCC TEST REPORT

Client Information:

Applicant: Changzhou Maofa Vehicle Accessories Co., Ltd.
Applicant add.: Building 15, Xinmenghe Industrial Park, Xinbei District, Changzhou City,
Jiangsu Province, China
Manufacturer: Changzhou Maofa Vehicle Accessories Co., Ltd.
Manufacturer add.: Building 15, Xinmenghe Industrial Park, Xinbei District, Changzhou City,
Jiangsu Province, China

Product Information:

Product Name: TOROIDAL COIL 15W
Model No.: MF-WXC-15W-V2
Brand Name: N/A
FCC ID: 2A7S2-MFWXCV2

Applicable standards: FCC CFR Title 47 Part 15 Subpart C

Prepared By:

Dongguan Yaxu (AiT) Technology Limited

No.22, Jinqianling 3rd Street, Jitigang, Huangjiang, Dongguan,
Guangdong, China

Tel.: +86-769-8202 0499 Fax.: +86-769-8202 0495

Date of Receipt: July 04, 2022

Date of Test: July 04~ July 24, 2022

Date of Issue: July 25, 2022

Test Result: Pass

This device described above has been tested by Dongguan Yaxu (AiT) Technology Limited and the test results show that the equipment under test (EUT) is in compliance with the FCC requirements. And it is applicable only to the tested sample identified in the report.

Note: This report shall not be reproduced except in full, without the written approval of Dongguan Yaxu (AiT) Technology Limited, this document may be altered or revised by Dongguan Yaxu (AiT) Technology Limited, personal only, and shall be noted in the revision of the document. This test report must not be used by the client to claim product endorsement.

Reviewed by: 
Simba Huang

Approved by: 
Seal.chen

1 Contents

	Page
COVER PAGE	
1	CONTENTS
2	
2 TEST SUMMARY	5
2.1 STATEMENT OF THE MEASUREMENT UNCERTAINTY	5
2.2 MEASUREMENT UNCERTAINTY	5
3 TEST FACILITY	6
3.1 DEVIATION FROM STANDARD	6
3.2 ABNORMALITIES FROM STANDARD CONDITIONS	6
3.3 TEST LOCATION	6
4 GENERAL INFORMATION	7
4.1 EUT TEST MODE	8
4.2 DESCRIPTION OF TEST SETUP	8
4.3 PERIPHERAL LIST	9
4.4 EUT PERIPHERAL LIST	9
5 EQUIPMENTS LIST FOR ALL TEST ITEMS	10
6 CONDUCTED EMISSION TEST	11
6.1 CONDUCTED EMISSION MEASUREMENT	11
6.2 POWER LINE CONDUCTED EMISSION LIMITS	11
6.3 TEST PROCEDURE	11
6.4 DEVIATION FROM TEST STANDARD	11
6.5 TEST SETUP	12
6.6 EUT OPERATING CONDITIONS	12
7 RADIATED EMISSION MEASUREMENT	13
7.1 RADIATED EMISSION LIMITS	13
7.2 ANECHOIC CHAMBER TEST SETUP DIAGRAM	14
7.3 TEST PROCEDURE	14
7.4 DEVIATION FROM TEST STANDARD	14
7.5 TEST RESULT	15
8 BANDWIDTH TEST	18
8.1 TEST PROCEDURE	18
8.2 TEST SETUP	18
9 ANTENNA REQUIREMENT:	20



10	TEST SETUP PHOTOGRAPHS OF EUT	21
11	EXTERNAL PHOTOGRAPHS OF EUT	21
12	INTERNAL PHOTOGRAPHS OF EUT	21

Revision History

Revision	Issue Date	Revisions	Revised By
000	July 25, 2022	Initial Issue	Seal Chen

2 Test Summary

Test Item	Section in CFR 47	Result
Antenna requirement	15.203	Pass
AC Power Line Conducted Emission	15.207	N/A
Spurious Emission	15.209(a)(f)	Pass
20dB Bandwidth	15.215	Pass

Note

1. Test according to ANSI C63.10:2013.
2. The measurement uncertainty is not included in the test result.
3. Test results in other test report (RF Exposure Evaluation Report)

2.1 Statement of the Measurement Uncertainty

The data and results referenced in this document are true and accurate. The reader is cautioned that there may be errors within the calibration limits of the equipment and facilities. The measurement uncertainty was calculated for all measurements listed in this test report acc. To CISPR 16 – 4 “Specification for radio disturbance and immunity measuring apparatus and methods – Part 4: Uncertainty in EMC Measurements” and is documented in the AiT quality system acc. To DIN EN ISO/IEC 17025. Furthermore, component and process variability of devices similar to that tested may result in additional deviation. The manufacturer has the sole responsibility of continued compliance of the device.

2.2 Measurement Uncertainty

Test Item	Frequency Range	Measurement Uncertainty	Notes
Radiated Emission	0.009MHz-30MHz	3.10dB	(1)
Radiated Emission	30MHz-1GHz	3.75dB	(1)
Radiated Emission	1GHz-18GHz	3.88dB	(1)
Radiated Emission	18GHz-40GHz	3.88dB	(1)
AC Power Line Conducted Emission	0.15MHz ~ 30MHz	1.20dB	(1)

Note (1): The measurement uncertainty is for coverage factor of k=2 and a level of confidence of 95%.

3 Test Facility

The test facility is recognized, certified or accredited by the following organizations:

.CNAS- Registration No: L6177

Dongguan Yaxu (AiT) technology Limited is accredited to ISO/IEC 17025:2017 general Requirements for the competence of testing and calibration laboratories (CNAS-CL01 Accreditation Criteria for the competence of testing and calibration laboratories) on Aug.04, 2020

FCC-Registration No.: 703111 Designation Number: CN1313

Dongguan Yaxu (AiT) technology Limited has been registered and fully described in a report filed with the (FCC) Federal Communications Commission. The acceptance letter from the FCC is maintained in our files.

IC —Registration No.: 6819A CAB identifier: CN0122

The 3m Semi-anechoic chamber of Dongguan Yaxu (AiT) technology Limited has been registered by Certification and Engineering Bureau of Industry Canada for radio equipment testing with Registration No.: 6819A

A2LA-Lab Cert. No.: 6317.01

Dongguan Yaxu (AiT) technology Limited has been accredited by A2LA for technical competence in the field of electrical testing, and proved to be in compliance with ISO/IEC 17025: 2017 General Requirements for the Competence of Testing and Calibration Laboratories and any additional program requirements in the identified field of testing.

3.1 Deviation from standard

None

3.2 Abnormalities from standard conditions

None

3.3 Test Location

Dongguan Yaxu (AiT) Technology Limited

Address: No.22, Jinqianling 3rd Street, Jitigang, Huangjiang,Dongguan, Guangdong, China

Tel.: +86-769-8202 0499

Fax.: +86-769-8202 0495

4 General Information

EUT Name:	TOROIDAL COIL 15W
Model No:	MF-WXC-15W-V2
Serial Model:	N/A
Test sample(s) ID:	22070403
Sample(s) Status:	Engineer sample
Serial No.:	N/A
Operation frequency:	111kHz-205kHz
Modulation Technology:	ASK
Antenna Type:	loop coil Antenna
Antenna gain:	0dBi
Hardware version.:	DF-10W-TC-V8
Software version.:	N/A
Power supply:	DC9-24V
Model different:	N/A
Note:	For a more detailed features description, please refer to the manufacturer's specifications or the User's Manual.

4.1 EUT Test Mode

Equipment under test was operated during the measurement under the following conditions:

Test Mode	Description	
Mode 1	AC Adapter + EUT + Mobile phone(15W)	Record
Mode 2	AC Adapter + EUT + Mobile phone(10W)	Pre-tested
Mode 3	AC Adapter + EUT + Mobile phone (7.5W)	Pre-tested
Mode 4	AC Adapter + EUT + Mobile phone (5W)	Pre-tested
Mode 5	Test the EUT in idle mode.	Pre-tested

Note: All test modes were pre-tested, but we only recorded the worst case in this report.

4.2 Description of Test setup

EUT was tested in normal configuration (Please See following Block diagram)

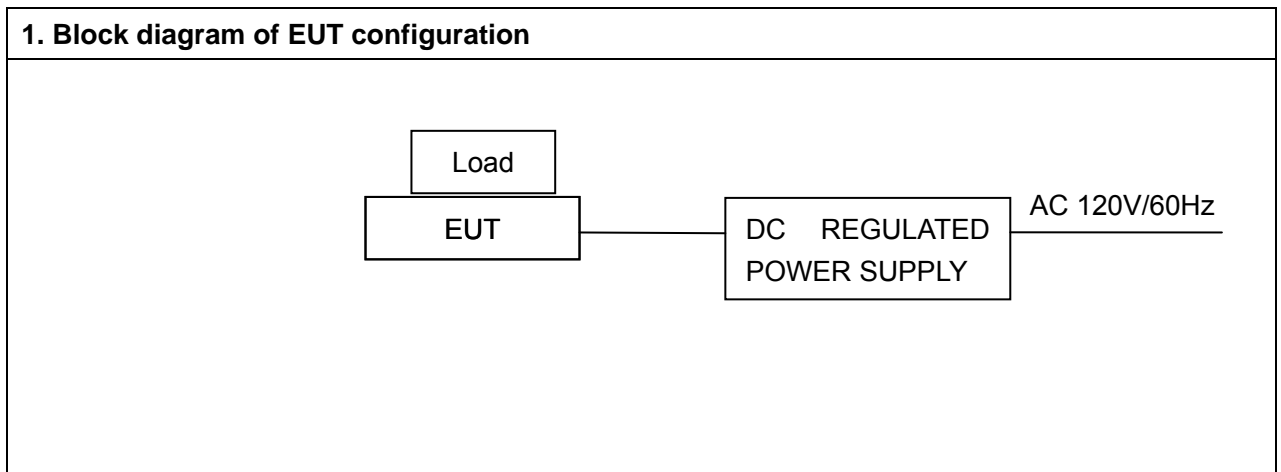

4.3 Peripheral List

No.	Equipment	Manufacturer	Model No.	Serial No.	Power cord	signal cable
1	DC REGULATED POWER SUPPLY	QJE	N/A	QJ3003XE	N/A	N/A
2	Mobile Iphone	Apple	Iphone 11	N/A	N/A	N/A

4.4 EUT Peripheral List

No.	Equipment	Manufacturer	EMC Compliance	Model No.	Serial No.	Power cord	signal cable
1	N/A	N/A	N/A	N/A	N/A	N/A	N/A

5 Equipments List for All Test Items

No	Test Equipment	Manufacturer	Model No	Serial No	Cal. Date	Cal. Due Date
1	Spectrum Analyzer	R&S	FSV40	101470	2021.08.30	2022.08.29
2	EMI Measuring Receiver	R&S	ESR	101660	2021.08.30	2022.08.29
3	Low Noise Pre Amplifier	HP	HP8447E	1937A01855	2021.08.30	2022.08.29
4	Low Noise Pre Amplifier	Tsj	MLA-0120-A02-34	2648A04738	2021.08.30	2022.08.29
5	Passive Loop	ETS	6512	00165355	2020.09.05	2022.09.04
6	TRILOG Super Broadband test Antenna	SCHWARZBECK	VULB9160	9160-3206	2021.08.29	2024.08.28
7	Broadband Horn Antenna	SCHWARZBECK	BBHA9120D	452	2021.08.29	2024.08.28
8	SHF-EHF Horn Antenna 15-40GHz	SCHWARZBECK	BBHA9170	BBHA9170367d	2020.11.24	2023.11.23
9	EMI Test Receiver	R&S	ESCI	100124	2021.08.30	2022.08.29
10	LISN	Kyoritsu	KNW-242	8-837-4	2021.08.30	2022.08.29
11	LISN	R&S	ESH3-Z2	0357.8810.54-101161-S2	2021.08.30	2022.08.29
12	Pro.Temp&Humi.chamber	MENTEK	MHP-150-1C	MAA08112501	2021.08.30	2022.08.29
13	RF Automatic Test system	MW	MW100-RFCB	21033016	2021.08.30	2022.08.29
14	Signal Generator	Agilent	N5182A	MY50143009	2021.08.30	2022.08.29
15	Wideband Radio communication tester	R&S	CMW500	1201.0002K50	2021.08.30	2022.08.29
16	RF Automatic Test system	MW	MW100-RFCB	21033016	2021.08.30	2022.08.29
17	DC power supply	ZHAOXIN	RXN-305D-2	28070002559	N/A	N/A
18	RE Software	EZ	EZ-EMC_RE	Ver.AIT-03A	N/A	N/A
19	CE Software	EZ	EZ-EMC_CE	Ver.AIT-03A	N/A	N/A
20	RF Software	MW	MTS 8310	2.0.0.0	N/A	N/A
21	temporary antenna connector(Note)	NTS	R001	N/A	N/A	N/A

6 CONDUCTED EMISSION TEST

6.1 CONDUCTED EMISSION MEASUREMENT

Test Requirement:	FCC Part15 C Section 15.207
Test Method:	ANSI C63.10:2013
Test Frequency Range:	150KHz to 30MHz
Receiver setup:	RBW=9KHz, VBW=30KHz, Sweep time=auto

6.2 POWER LINE CONDUCTED EMISSION Limits

FREQUENCY (MHz)	Limit (dBuV)		Standard
	Quas -peak	Average	
0.15 -0.5	66 - 56 *	56 - 46 *	FCC
0.50 -5.0	56.00	46.00	FCC
5.0 -30.0	60.00	50.00	FCC

Note:

(1) *Decreases with the logarithm of the frequency.

6.3 TEST PROCEDURE

- The EUT was placed 0.8 meters from the horizontal ground plane with EUT being connected to the power mains through a line impedance stabilization network (LISN). All other support equipments powered from additional LISN(s). The LISN provide 50 Ohm/ 50uH of coupling impedance for the measuring instrument.
- Interconnecting cables that hang closer than 40 cm to the ground plane shall be folded back and forth in the center forming a bundle 30 to 40 cm long.
- I/O cables that are not connected to a peripheral shall be bundled in the center. The end of the cable may be terminated, if required, using the correct terminating impedance. The overall length shall not exceed 1 m.
- LISN at least 80 cm from nearest part of EUT chassis.
- For the actual test configuration, please refer to the related Item –EUT Test Photos.

6.4 DEVIATION FROM TEST STANDARD

No deviation

6.5 TEST SETUP

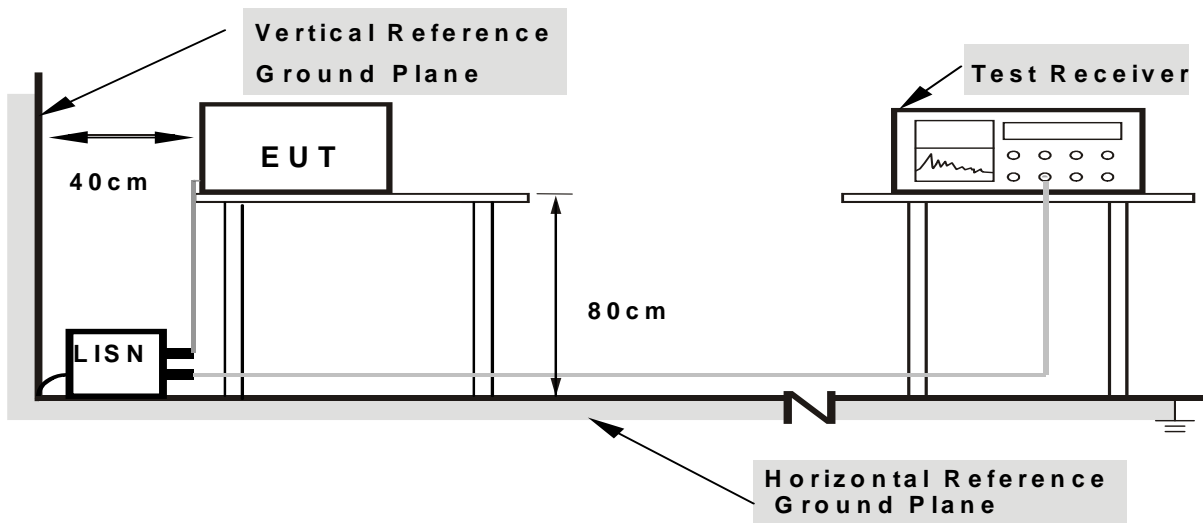

- Note:**
1. Support units were connected to second LISN.
 2. Both of LISNs (AMN) are 80 cm from EUT and at least 80 cm from other units and other metal planes

6.6 EUT OPERATING CONDITIONS

The EUT was configured for testing in a typical fashion (as a customer would normally use it). The EUT has been programmed to continuously transmit during test. This operating condition was tested and used to collect the included data.

N/A

The EUT is powered by DC power.

7 RADIATED EMISSION MEASUREMENT

Test Requirement:	FCC Part15 C Section 15.209				
Test Method:	ANSI C63.10:2013				
Test Frequency Range:	9kHz to 1GHz				
Test site:	Measurement Distance: 3m				
Receiver setup:	Frequency	Detector	RBW	VBW	Value
	9KHz-150KHz	Quasi-peak	200Hz	600Hz	Quasi-peak
	150KHz-30MHz	Quasi-peak	9KHz	30KHz	Quasi-peak
	30MHz-1GHz	Quasi-peak	100KHz	300KHz	Quasi-peak
	Above 1GHz	Peak	1MHz	3MHz	Peak
		Peak	1MHz	10Hz	Average

7.1 Radiated Emission Limits

Limits for frequency below 30MHz

Frequency	Limit (uV/m)	Measurement Distance(m)	Remark
0.009-0.490	2400/F(kHz)	300	Quasi-peak Value
0.490-1.705	24000/F(kHz)	30	Quasi-peak Value
1.705-30	30	30	Quasi-peak Value

Limits for frequency Above 30MHz

Frequency	Limit (dBuV/m @3m)	Remark
30MHz-88MHz	40.00	Quasi-peak Value
88MHz-216MHz	43.50	Quasi-peak Value
216MHz-960MHz	46.00	Quasi-peak Value
960MHz-1GHz	54.00	Quasi-peak Value
Above 1GHz	54.00	Average Value
	74.00	Peak Value

7.2 Anechoic Chamber Test Setup Diagram

(A) Radiated Emission Test-Up Frequency Below 30MHz

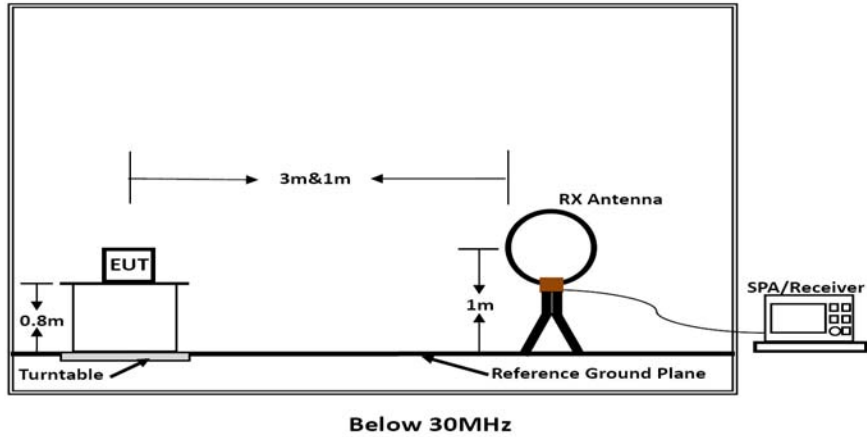

(B) Radiated Emission Test-Up Frequency 30MHz~1GHz

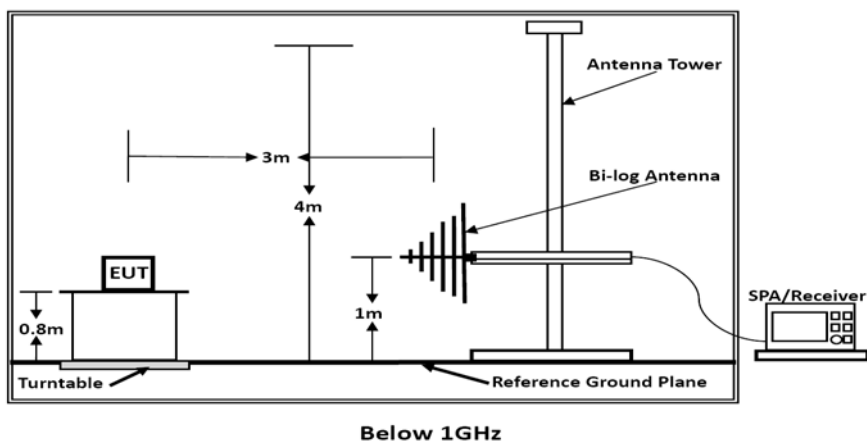

The radiated emission tests were performed in the 3 meters chamber test site, using the setup accordance with the ANSI C63.10-2013. The specification used was the FCC 15.209 and FCC 15.205 limits.

7.3 Test Procedure

The EUT is placed on a turn table which is 0.8 meter above ground. The turn table can rotate 360 degrees to determine the position of the maximum emission level. The EUT is set 3 meters away from the receiving antenna which is mounted on a antenna tower. The antenna can move up and down between 1 to 4 meters to find out the maximum emission level. Broadband antenna (calibrated by dipole antenna) are used as a receiving antenna. Both horizontal and vertical polarization of the antenna are set on measurement.

7.4 DEVIATION FROM TEST STANDARD

No deviation

7.5 Test Result

We pretest AC 120V and AC 230V in full load, half load and no load, the worst voltage was AC 120V in full load and the data recording in the report.

Measurement data:

Note: Limit dBuV/m @3m = Limit dBuV/m @300m+ 80

Limit dBuV/m @3m = Limit dBuV/m @30m + 40

9 kHz~30 MHz

Frequency (MHz)	Meter Reading (dBμV)	Factor (dB/m)	Emission Level (dBμV/m)	Limits (dBμV/m)	Margin (dB)	Detector Type
0.0497	29.74	50.35	80.09	113.5	-33.48	Quasi-Peak
0.1110	37.23	41.06	78.29	106.6	-28.33	Peak
0.1110	27.90	41.06	68.96	106.6	-37.66	Average
0.2605	27.49	36.20	63.69	99.26	-35.57	Quasi-Peak
0.4637	20.76	31.13	51.89	94.27	-42.38	Quasi-Peak
1.2681	18.40	24.99	43.39	65.56	-22.17	Quasi-Peak
4.9150	20.85	15.24	36.09	69.50	-33.41	Quasi-Peak

Note:

Pre-scan in the all of mode, the worst case in of was recorded.

Factor = antenna factor + cable loss – pre-amplifier.

Margin = Emission Level- Limit.

30MHz-1GHz

Temperature:	25.5°C	Relative Humidity:	52.3%
Pressure:	101 kPa	Polarization:	Horizontal
Test Voltage:	AC 120V/60Hz		

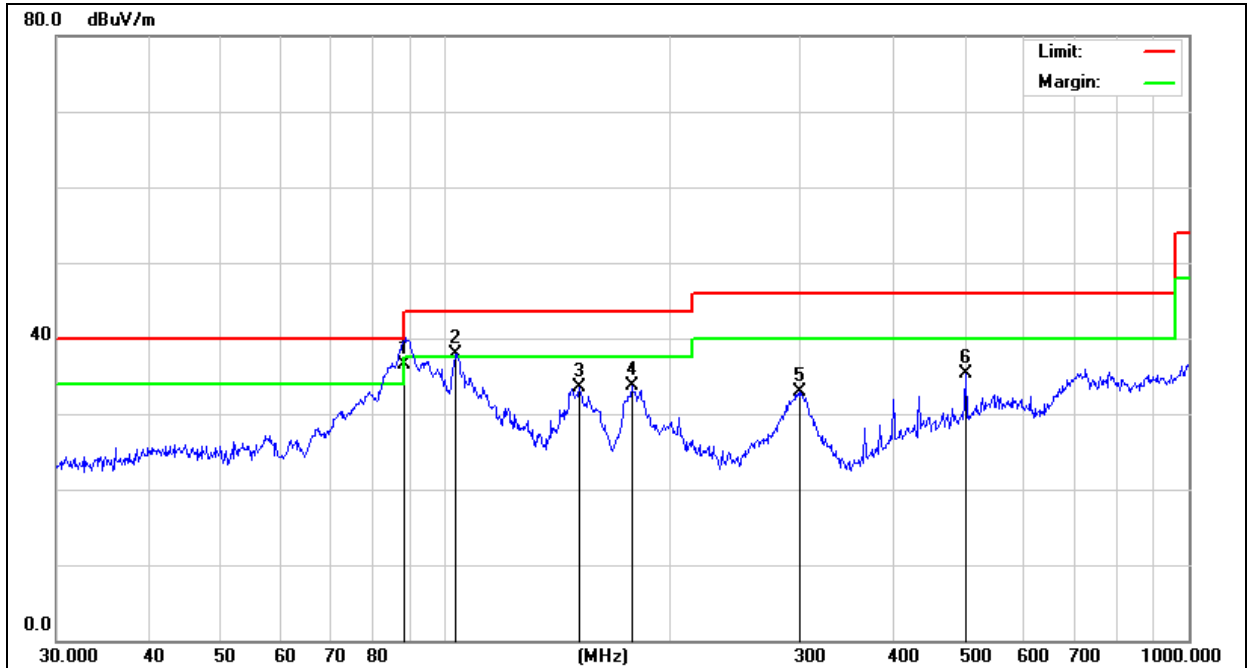

No.	Mk.	Freq. MHz	Reading Level dBuV	Correct Factor dB/m	Measure- ment dBuV/m	Limit dBuV/m	Over dB	Detector
1	*	88.0000	46.00	-9.43	36.57	40.00	-3.43	QP
2	!	103.0800	45.53	-7.55	37.98	43.50	-5.52	QP
3		151.5972	40.36	-6.81	33.55	43.50	-9.95	QP
4		178.1327	40.60	-6.95	33.65	43.50	-9.85	QP
5		300.3672	37.71	-4.83	32.88	46.00	-13.12	QP
6		501.1790	32.73	2.54	35.27	46.00	-10.73	QP

Temperature:	25.5°C	Relative Humidity:	52.3%
Pressure:	101kPa	Polarization:	Vertical
Test Voltage:	AC 120V/60Hz		

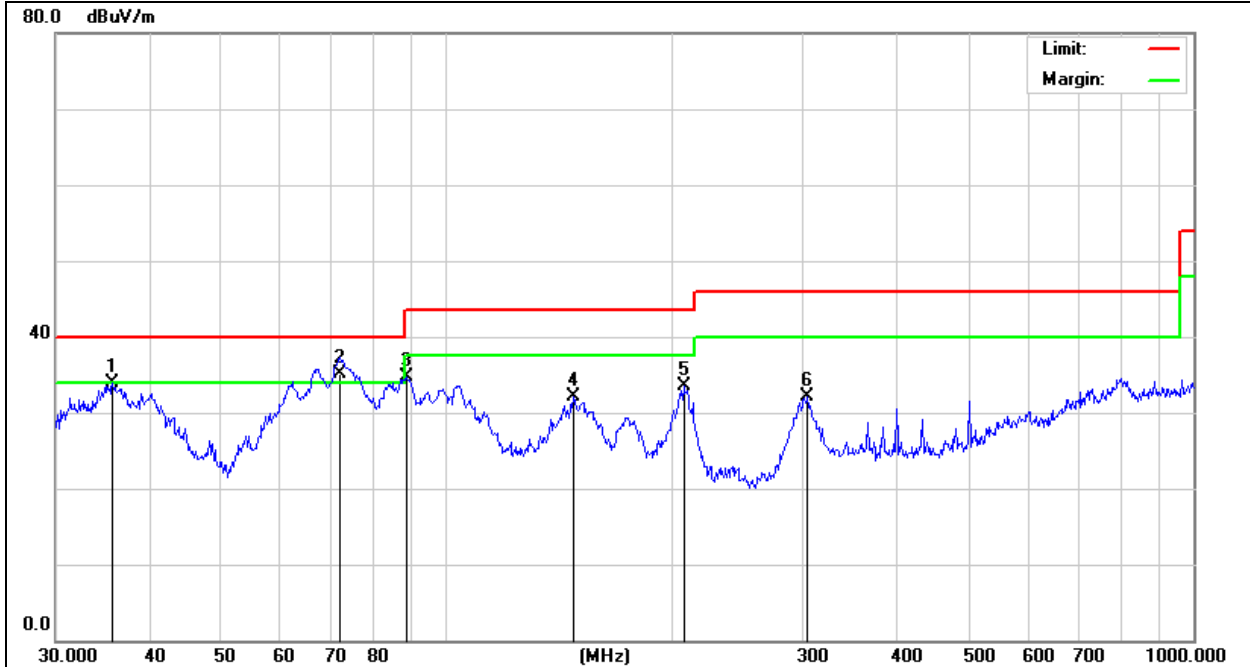

No.	Mk.	Freq. MHz	Reading Level dBuV	Correct Factor dB/m	Measure- ment dBuV/m	Limit dBuV/m	Over dB	Detector
1		35.7490	38.62	-4.71	33.91	40.00	-6.09	QP
2	*	72.2355	45.58	-10.44	35.14	40.00	-4.86	QP
3		88.6524	45.38	-10.63	34.75	43.50	-8.75	QP
4		147.9214	39.56	-7.55	32.01	43.50	-11.49	QP
5		207.8501	38.04	-4.63	33.41	43.50	-10.09	QP
6		304.6099	36.13	-4.10	32.03	46.00	-13.97	QP

Remarks:

1. Final Level = Receiver Read level + Antenna Factor + Cable Loss – Preamplifier Factor
2. The emission levels of other frequencies are very lower than the limit and not show in test report.

8 BANDWIDTH TEST

8.1 Test Procedure

1. Set RBW = 3 kHz.
2. Set the video bandwidth (VBW) $\geq 3 \times$ RBW.
3. Detector = Peak.
4. Trace mode = max hold.
5. Sweep = auto couple.
6. Allow the trace to stabilize.
7. Measure the maximum width of the emission that is constrained by the frequencies associated with the two outermost amplitude points (upper and lower frequencies) that are attenuated by 20 dB relative to the maximum level measured in the fundamental emission.

8.2 Test setup

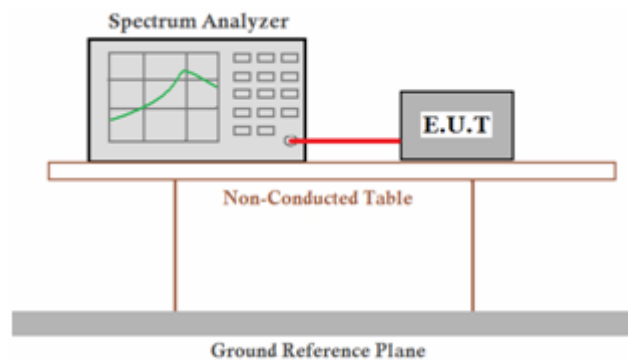

Temperature:	25 °C	Relative Humidity:	54%
Pressure:	101kPa		

Frequency (KHz)	20dB bandwidth (KHz)	99% bandwidth (KHz)	Result
111.842	2.6657	-	Pass

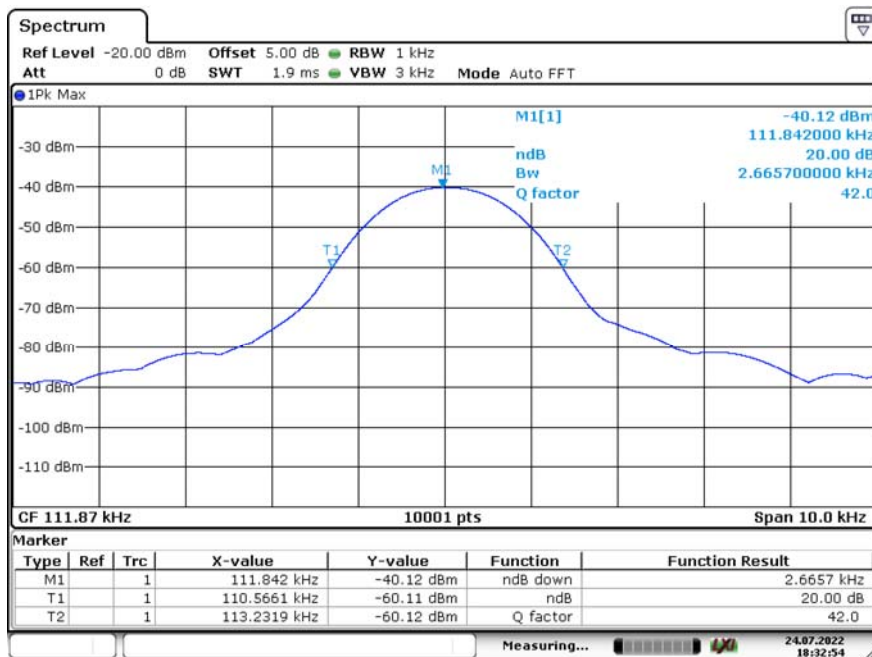

9 ANTENNA REQUIREMENT:

Standard requirement: FCC Part15 C Section 15.203

An intentional radiator shall be designed to ensure that no antenna other than that furnished by the responsible party shall be used with the device. The use of a permanently attached antenna or of an antenna that uses a unique coupling to the intentional radiator, the manufacturer may design the unit so that a broken antenna can be replaced by the user, but the use of a standard antenna jack or electrical connector is prohibited.

EUT Antenna:

The antenna is Inductive loop coil Antenna, the best case gain of the antenna is 0dBi, reference to the appendix for details.

10 Test Setup Photographs of EUT

Please refer to separated files for Test Setup Photos of the EUT.

11 External Photographs of EUT

Please refer to separated files for External Photos of the EUT.

12 Internal Photographs of EUT

Please refer to separated files for Internal Photos of the EUT.

**** End of report ****