

CONFIDENTIAL

LT102XK UWB Radar Module

Datasheet | Rev. 1.1

LT102XK UWB Radar Module

Datasheet | Rev. 1.1

1 Summary

LT102XK radar module is a turn-key Ultra-Wide Band radar system for indoor applications. LT102XK integrates high-end directive UWB antennas, the signal processing unit, and the communication interfaces. It is designed to fit EU EN 302 065 (EU), FCC CFR 47 Part 15 (USA), RS220 03/2009 (Canada), UWB Regulations.

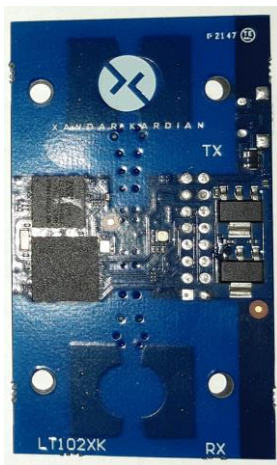

General Specifications

- Typ. Detection range: up to 12 meters
- Maximum power consumption: 200mA@5V
- Operating frequency: 6.5GHz to 8.5GHz
- Power supply: 5Vdc or USB 5Vdc
- Temperature range: -40°C to +85°C
- Integrated Antenna (aperture $\pm 60^\circ$ by $\pm 60^\circ$)
- Communication interfaces: USB full speed, SPI, UART
- Dimensions: 36mm x 68mm

Applications:

- Presence detection
- Position tracking
- Breath detection and monitoring
- People counting
- Gesture recognition

Table of contents

1	Summary	1
2	Features	2
3	Operating Principle	2
4	Electrical specification.....	3
5	Block Diagram	3

6	Module connection	4
6.1	USB operation	4
6.2	Auxiliary IO connector.....	4
7	Antenna Performances	5

2 Features

The LT102XK is a high configurable UWB radar. This module combines a full UWB transceiver and an on board MCU. The module is targeted for application like presence detection, position tracking, breath detection and analysis. The communication is achieved by an USB full speed (virtual com port). The module has an auxiliary connector that may be used as GPIOs or additional communication interface such as SPI and UART. The module is USB powered.

3 Operating Principle

The operating principle of the system is based on the direct readout of the backscattered pulse

- The transmitter emits pulses (Fig. 1a) which travels into space and hits the targets that are into active area of the radar
- The targets reflect part of the incoming energy (echoes) backward to the radar module (Fig. 1b).
- The receiver converts the incoming signal to digital data, these data are provided to the MCU and processed according to the application.

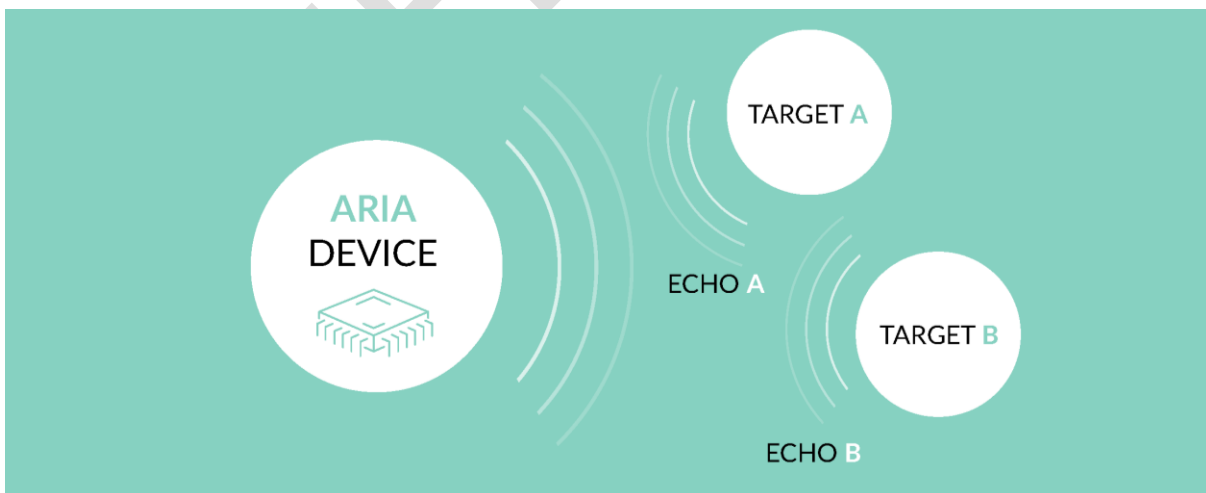

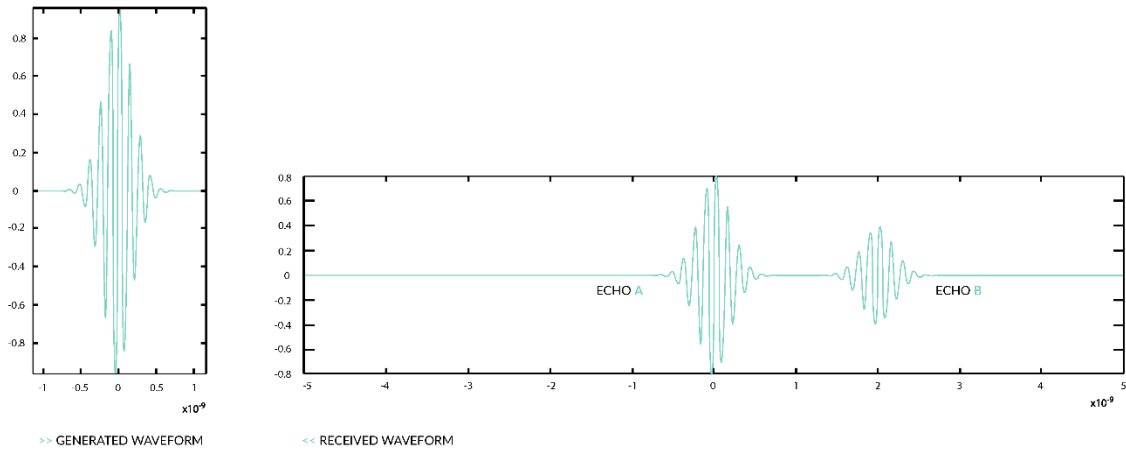

Fig. 1: The basic principle and the waveforms

4 Electrical specification

	Min	Typ	Max
Operating frequency	6.5GHz	7.29GHz	8.5GHz
Mean e.i.r.p. density			-41.3dBm/MHz
Peak e.i.r.p. density			0dBm/50MHz
Supply voltage (USB)	4.5Vdc	5Vdc	5.5Vdc
Current consumption (AuxIO)		120mA	200mA
Range resolution		6mm	
V _{IL}			0.3 Vdd
V _{IH}	0.7Vdd		
R _{series} (AuxIO protection)		220 Ohm	

5 Block Diagram

The block diagram of the LT102XK is reported next.

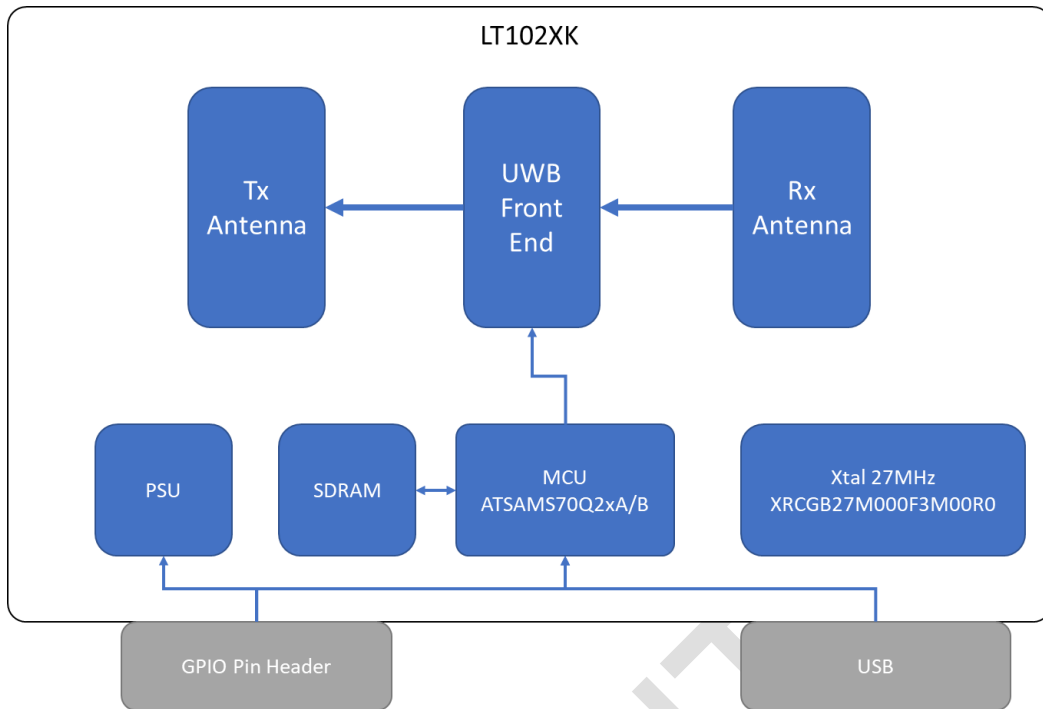

Fig. 2 LT102XK System Diagram

6 Module connection

6.1 USB operation

In a default configuration, the LT102XK module can be attached to a PC through a A-plug, micro-B USB cable. In this configuration, the power supply of the LT102XK is taken from the +Vcc pin of the USB cable.

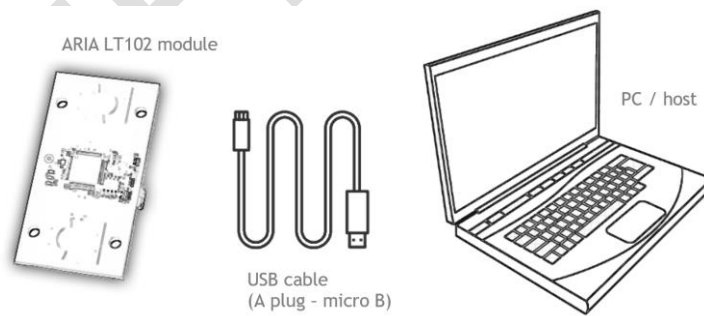

Fig. 3: Plug and Play configuration.

6.2 Auxiliary IO connector

The module provides an auxiliary connector (AuxIO) that may be used to control external electronics, or as alternate communication interface (SPI and/or UART).

When both the USB plug and the AuxIO connector are connected the power supply is taken from USB connector.

Pin	Description
-----	-------------

1	Vext: External Power Supply
2	Gnd: External Ground
3	RXD: UART Interface RX
4	TXD: UART Interface Tx
5	SPI0_CLK: SPI Interface #0, CLK Signal
6	SPI0_CS2: SPI Interface #0, Chip Select (active low)
7	RST: Reset (active low)
8	TDO: JTAG Interface TDO
9	SWCLK/TCLK: JTAG Interface CLK / Serial Wire Debug Interface CLK
10	TMS/SWDIO: JTAG Interface TSM / Serial Wire Debug Interface TMS
11	IO0: General Purpose I/O 0
12	IO1: General Purpose I/O 1
13	TDI: JTAG Interface TDI
14	ERASE: Erase internal flash. Leave open. To erase device flash connect to Vdd during startup
15	SPI0_MOSI: SPI Interface #0, MOSI
16	SPI0_MISO: SPI Interface #0, MISO

Table 1: AuxIO Pinout description

7 Antenna Performances

Antenna data are reported @ 7.5GHz. Maximum gain is 5.6dBi with HPBW = 71° x 84°

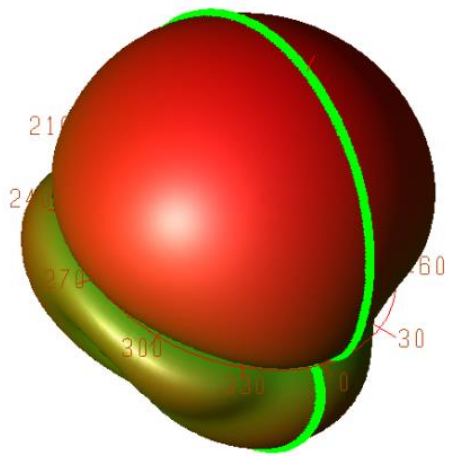

Fig. 4 Antenna Diagram and X-Z plane cut

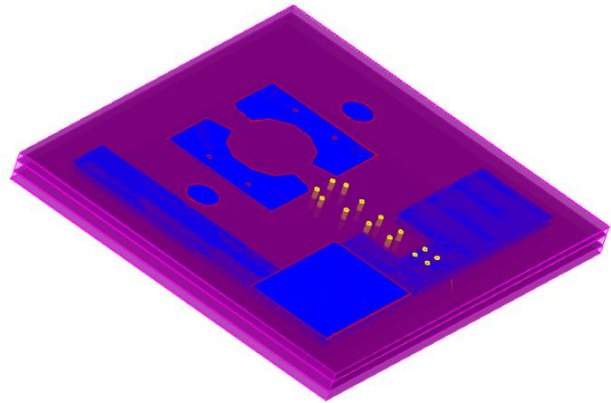

Fig. 5 Aligned View of X-Z plane

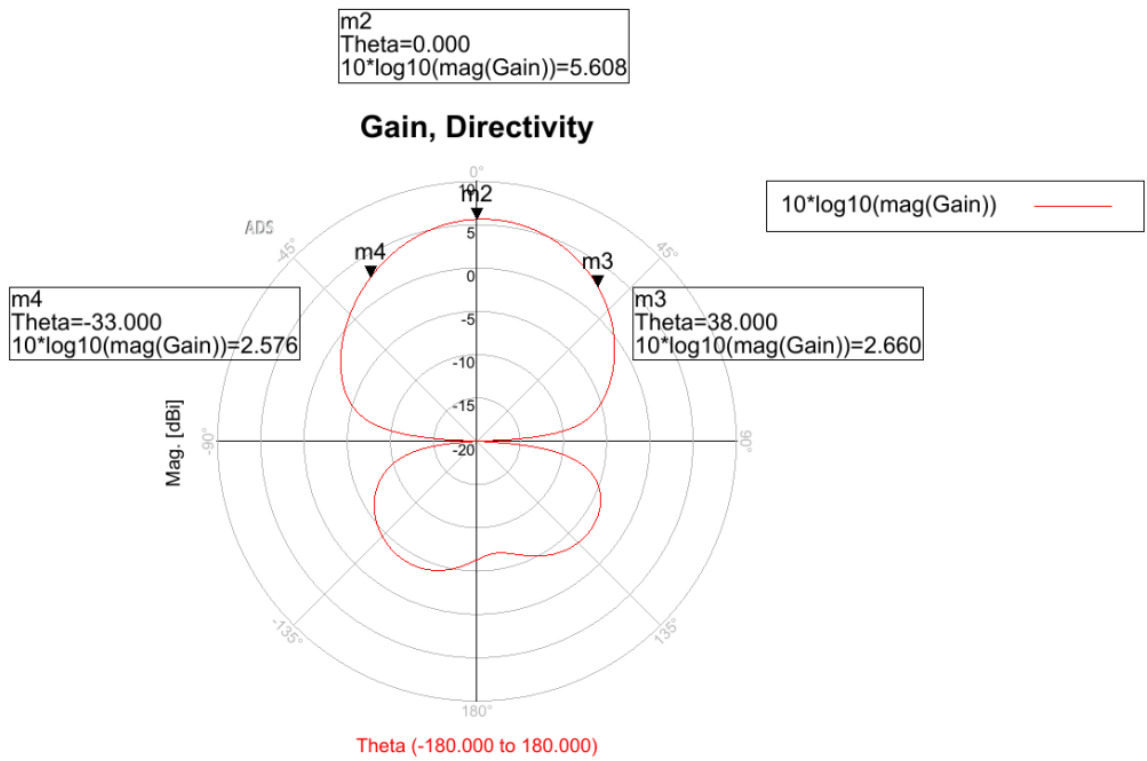

Fig. 6 Antenna Gain over X-Z plane

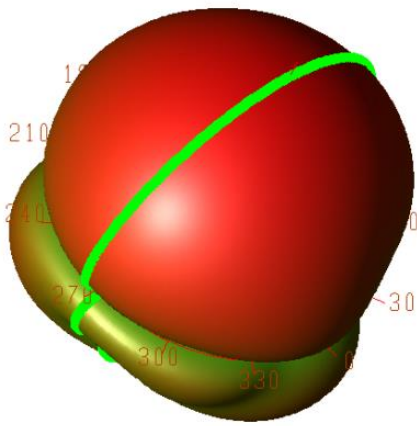

Fig. 7 Antenna Diagram and Y-Z plane cut

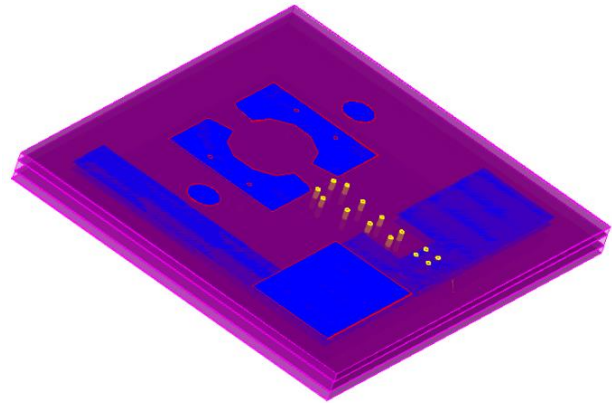
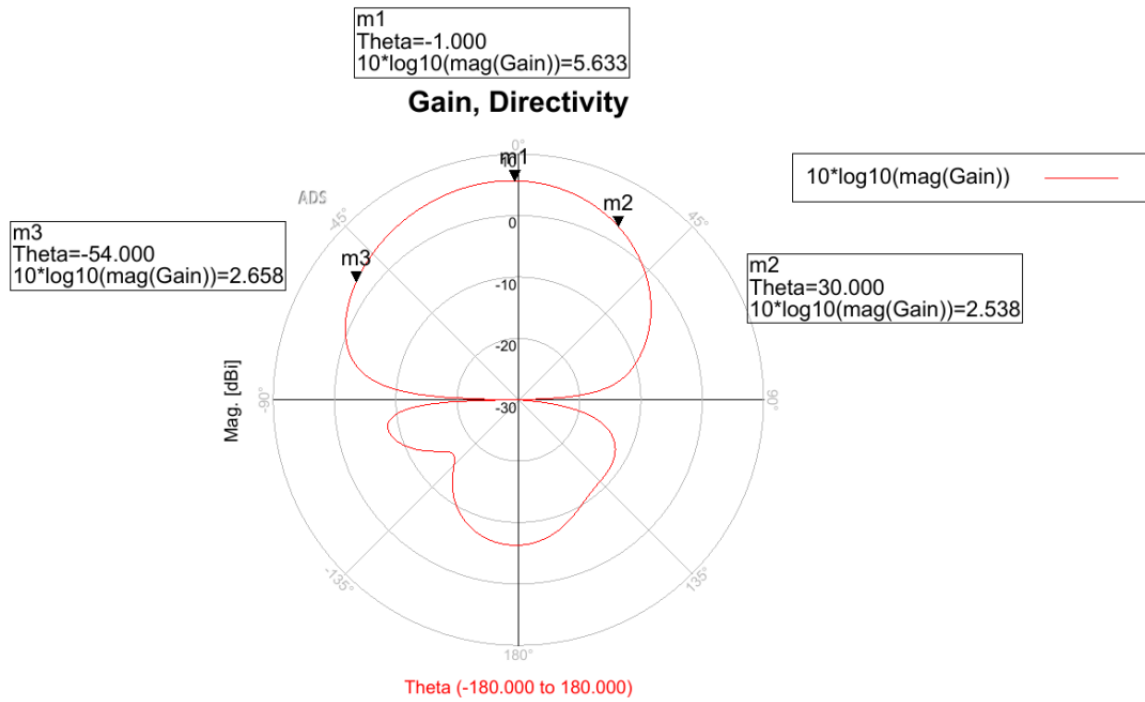

Fig. 8 Aligned View of Y-Z plane



8 Restriction

- In accordance with Commission Decision 2000/299/CE of 6 April 2000, the device is classified as Class I, Subclass 57e “Equipment using Ultra-Wideband Technology (Location tracking systems)”
- The LT102XK is a Class I, Subclass 57e device. It is intended for indoor and in-vehicle use only.
- The LT102XK is sensitive to direct sun and visible/IR light. It is recommended to shield it.

- To guarantee the maximum detection distance (10m) the LT102XK must be kept at least 2m away from a 5GHz WiFi device.
- If the maximum range is less or equal than 5m, there is no minimum distance to 5GHz WiFi devices

9 Regulatory Information USA

Changes or modifications not expressly approved by the party responsible for compliance could void the user's authority to operate the equipment.

This device complies with part 15 of the FCC Rules. Operation is subject to the following two conditions: (1) This device may not cause harmful interference, and (2) this device must accept any interference received, including interference that may cause undesired operation.

This equipment has been tested and found to comply with the limits for a Class B digital device, pursuant to part 15 of the FCC Rules. These limits are designed to provide reasonable protection against harmful interference in a residential installation. This equipment generates, uses, and can radiate radio frequency energy and, if not installed and used in accordance with the instructions, may cause harmful interference to radio communications. However, there is no guarantee that interference will not occur in a particular installation. If this equipment does cause harmful interference to radio or television reception, which can be determined by turning the equipment off and on, the user is encouraged to try to correct the interference by one or more of the following measures:

- Reorient or relocate the receiving antenna.
- Increase the separation between the equipment and receiver.
- Connect the equipment into an outlet on a circuit different from that to which the receiver is connected.
- Consult the dealer or an experienced radio/TV technician for help.

9.1 RF exposure safety

It is designed not to exceed the emission limits for exposure to radio frequency (RF) energy set by the Federal Communications Commission.

9.2 Labelling Requirements for the Host Device

The host device shall be properly labelled to identify the modules within the host device. The certification label of the module shall be clearly visible at all times when installed in the host device, otherwise, the host device must be labelled to display the FCC ID of the module, preceded by the words "Contains transmitter module", or the word "Contains", or similar wording expressing the same meaning, as follows:

FCC ID: 2A7RF-LT102XK

UWB devices may not be employed for the operation of toys. Operation on-board an aircraft, a ship or a satellite is prohibited.

9.3 Compliance of Host Devices

The module has been evaluated in portable stand-alone conditions. For different operational conditions from a stand-alone modular transmitter in a host (multiple, simultaneously transmitting modules or other transmitters in a host), additional testing may be required (collocation, retesting...).

The modular transmitter is only FCC authorized for the specific rule parts (i.e., FCC transmitter rules) listed on the grant, and that the host product manufacturer is responsible for compliance to any other FCC rules that apply to the host not covered by the modular transmitter grant of certification. If the grantee markets their product as being Part 15 Subpart B compliant (when it also contains unintentional-radiator digital circuitry), then the grantee shall provide a notice stating that the final host product still requires Part 15 Subpart B compliance testing with the modular transmitter installed. The end product with an embedded module may also need to pass the FCC Part 15 unintentional emission testing requirements and be properly authorized per FCC Part 15.