



<b>TEST REPORT</b>	
<b>Report Number</b> ..... :	90051-24-72-24-PP002
<b>Date of issue</b> .....	2023-12-28
<b>Prepared by (+signature)</b> ..... :	Pale 
<b>Reviewer (+signature)</b> ..... :	Duke 
<b>Approved by (+signature)</b> .....	Jason 
<b>Testing Laboratory name</b> ..... :	SLG-CPC Testlaboratory Co., Ltd.
<b>Address</b> .....	No. 11, Wu Song Road, Dongcheng District, Dongguan, Guangdong Province, China 523117
<b>Applicant's name</b> .....	CG Mobile SAS
<b>Address</b> .....	39 rue de Courcelles 75008 PARIS
<b>Manufacturer's name</b> .....	Guangzhou Rikiki Tech CO., LTD
<b>Address</b> .....	B2 of Greenland Central Plaza, Huangpu District, GZ
<b>Factory's name</b> .....	Guangzhou Rikiki Tech CO., LTD
<b>Address</b> .....	B2 of Greenland Central Plaza, Huangpu District, GZ
<b>Standard(s)</b> ..... :	FCC 47 CFR Part 15, Subpart C
<b>Test item description</b> ..... :	Wireless earbuds
<b>Trade Mark</b> ..... :	N/A
<b>Model/Type reference</b> ..... :	Y113S, GUTWSHDGKEEK, GUTWSHDGKEED, GUTWSHDGKEEP, GUTWSHDGKEEU, GUTWSHDGKTEK, GUTWSHDGKTED, GUTWSHDGKTEP, GUTWSHDGKTEU, HKTWSHDGKEP, HKTWSHDGKEU, HKTWSHDGKEQ, HKTWSHDGKEK, HELLO KITTY TWS
<b>FCC ID</b> ..... :	2A7J2HKTWS
<b>Date of receipt of test item</b> .. :	2023-12-01
<b>Date (s) of performance of test</b> ..... :	2023-12-12 to 2023-12-27
<b>Summary of Test Results</b> ..... :	<b>Pass</b>
The Summary of Test Results based on a technical opinion belongs to the standard(s).	
<b>General disclaimer:</b>	
This report shall not be reproduced except in full, without the written approval of SLG-CPC Testlaboratory Co., Ltd. The test results in the report only apply to the tested sample.	

## TABLE OF CONTENTS

1	EUT TECHNICAL DESCRIPTION .....	4
2	SUMMARY OF TEST RESULT .....	5
3	TEST METHODOLOGY .....	6
	3.1 GENERAL DESCRIPTION OF APPLIED STANDARDS .....	6
	3.2 MEASUREMENT EQUIPMENT USED .....	6
	3.3 DESCRIPTION OF TEST MODES .....	7
4	FACILITIES AND ACCREDITATIONS .....	8
	4.1 FACILITIES .....	8
	4.2 LABORATORY ACCREDITATIONS AND LISTINGS .....	8
5	TEST SYSTEM UNCERTAINTY .....	9
6	SETUP OF EQUIPMENT UNDER TEST .....	10
	6.1 RADIO FREQUENCY TEST SETUP 1 .....	10
	6.2 RADIO FREQUENCY TEST SETUP 2 .....	10
	6.3 CONDUCTED EMISSION TEST SETUP .....	12
	6.4 BLOCK DIAGRAM CONFIGURATION OF TEST SYSTEM .....	13
	6.5 SUPPORT EQUIPMENT .....	13
7	TEST REQUIREMENTS .....	14
	7.1 DTS 6DB BANDWIDTH .....	14
	7.2 MAXIMUM PEAK CONDUCTED OUTPUT POWER .....	18
	7.3 MAXIMUM POWER SPECTRAL DENSITY .....	22
	7.4 UNWANTED EMISSIONS IN NON-RESTRICTED FREQUENCY BANDS .....	26
	7.5 RADIATED SPURIOUS EMISSION .....	35
	7.6 CONDUCTED EMISSIONS TEST .....	47
	7.7 ANTENNA APPLICATION .....	48

**Modified Information**

Report No.	Revision Data	Summary
90051-24-72-24-PP002	2023-12-28	Original Version

## 1 EUT TECHNICAL DESCRIPTION

<b>Product</b>	Wireless earbuds
<b>Model Number</b>	Y113S, GUTWSHDGKEEK, GUTWSHDGKEED, GUTWSHDGKEEP, GUTWSHDGKEEU, GUTWSHDGKTEK, GUTWSHDGKTED, GUTWSHDGKTEP, GUTWSHDGKTEU, HKTWSHDGKEP, HKTWSHDGKEU, HKTWSHDGKEQ, HKTWSHDGKEK, HELLO KITTY TWS (All models are identical except for the model name and color; All tests were performed on model Y113S)
<b>Device Type</b>	Bluetooth V5.3
<b>Data Rate :</b>	1Mbps or 2Mbps for GFSK modulation
<b>Modulation:</b>	Bluetooth DTS: GFSK
<b>Operating Frequency Range:</b>	2402-2480MHz
<b>Number of Channels:</b>	40 Channels for Bluetooth DTS
<b>Transmit Power Max:</b>	-2.59 dBm
<b>Antenna Type:</b>	Chip Antenna
<b>Antenna Gain:</b>	2.7 dBi
<b>Power supply</b>	Input: DC 5V Battery Capacity: 3.7V 30mAh Charging box: DC 3.7V 230mAh
<b>Temperature Range:</b>	-20°C ~ +55°C

*Note: for more details, please refer to the User's manual of the EUT.*

## 2 SUMMARY OF TEST RESULT

FCC Part Clause	Test Parameter	Verdict	Remark
15.247(a)(2)	DTS (6dB) Bandwidth	PASS	
15.247(b)(3)	Maximum Peak Conducted Output Power	PASS	
15.247(e)	Maximum Power Spectral Density Level	PASS	
15.247(d)	Unwanted Emission Into Non-Restricted Frequency Bands	PASS	
15.247(d) 15.209	Unwanted Emission Into Restricted Frequency Bands (conducted)	PASS	
15.247(d) 15.209	Radiated Spurious Emission	PASS	
15.207	Conducted Emission Test	N/A	
15.247(b)	Antenna Application	PASS	
	NOTE1: N/A (Not Applicable) NOTE2: According to FCC KDB 558074 D01 15.247 Meas Guidance v05r02, the report use radiated measurements in the restricted frequency bands. In addition, the radiated test is also performed to ensure the emissions emanating from the device cabinet also comply with the applicable limits.		

### RELATED SUBMITTAL(S) / GRANT(S):

This submittal(s) (test report) is intended for FCC ID: 2A7J2HKTWS filing to comply with Section 15.247 of the FCC Part 15, Subpart C Rules.

### 3 TEST METHODOLOGY

#### 3.1 GENERAL DESCRIPTION OF APPLIED STANDARDS

According to its specifications, the EUT must comply with the requirements of the following standards:

FCC 47 CFR Part 2, Subpart J

FCC 47 CFR Part 15, Subpart C

FCC KDB 558074 D01 15.247 Meas Guidance v05r02

#### 3.2 MEASUREMENT EQUIPMENT USED

Equipment	Manufacturer	Model	S/N	Last Cal.	DUE Cal.
<b>RF Connected Test</b>					
Vector Signal Generator	Rohde & Schwarz	SMBV100B(6G)	101166	2023/06/04	1 year
Analog Signal Generator	Rohde & Schwarz	SMB100A(40G)	181333	2023/08/04	1 year
Signal Analyzer	Rohde & Schwarz	FSV40	101527	2023/03/29	1 year
Power Analyzer	Rohde & Schwarz	OSP-B157W8	N/A	2023/06/02	1 year
Wideband Radio Communication Tester	R&S	CMW270	101985	2023/06/16	1 year
Wideband Radio Communication Tester	Rohde & Schwarz	CMW500	166898	2023/06/16	1 year
Temperature&Humidity test chamber	ESPEC	VC 4018	/	2023/03/29	1 year
<b>Radiated Emission Test</b>					
EMI Test Receiver	KEYSIGHT	N9010A	MY56070465	2023/12/05	1 year
EMI Test Receiver	Rohde & Schwarz	FSV40	101511	2023/03/29	1 year
Bilog Antenna	Schwarzbeck	VULB 9163	01335	2023/04/21	3 year
Broadband Antenna	Schwarzbeck	9162	139	2022/03/22	3 year
Power Amplifier	EMEC	EM330	060676	2022/12/07	3 year
Cable	Tuyue	F4309	L-400-NmNm-12000	2022/12/07	2 year
Horn Antenna	Schwarzbeck	BBHA9120D	1779	2022/04/21	3 year
Horn Antenna	Schwarzbeck	BBHA9170	00954	2022/09/13	3 year
Power Amplifier	Rohde & Schwarz	SCU-18F	180118	2022/04/21	3 year
Power Amplifier	Rohde & Schwarz	SCU40A	100499	2023/06/21	3 year
Active Loop Antenna	ETS LINDGREN	6512	41623	2022/04/23	3 year
Test Software	Farad	EZ-EMC	Ver.CPC-3A1	/	/
<b>Conducted Emission Test</b>					
LISN	Schwarzbeck	NSLK 8127	8127-892	2023/03/21	1 year
LISN	Schwarzbeck	NSLK 8127	8127-437	2023/07/07	1 year
EMI Test Receiver	R&S	ESR3	102124	2023/12/05	1 year
Triple loop	R&S	HM020	834206/006	2022/12/07	2 year
Pulse Limiter	R&S	ESH3-Z2	357.8810.52	2023/12/05	1 year
Test Software	Farad	EZ-EMC	Ver.CPC-3A1	/	/

### 3.3 DESCRIPTION OF TEST MODES

The EUT has been tested under its typical operating condition.

The EUT configuration for testing is installed on RF field strength measurement to meet the Commissions requirement and operating in a manner which intends to maximize its emission characteristics in a continuous normal application.

The Transmitter was operated in the normal operating mode. The TX frequency was fixed which was for the purpose of the measurements.

Test of channel included the lowest and middle and highest frequency to perform the test, then record on this report.

Those data rates (Bluetooth V5.3 DTS : 1Mbps or 2Mbps) were used for all test.

Pre-defined engineering program for regulatory testing used to control the EUT for staying in continuous transmitting and receiving mode is programmed.

Frequency and Channel list for Bluetooth V5.3 DTS:

Channel	Frequency (MHz)	Channel	Frequency (MHz)	Channel	Frequency (MHz)
0	2402	19	2440	...	...
1	2404	20	2442	37	2476
2	2406	21	2444	38	2478
...	...	...	...	39	2480

Note:  $f_c=2402\text{MHz}+k\times 1\text{MHz}$   $k=1$  to 39

Test Frequency and channel for Bluetooth V5.3 DTS:

Lowest Frequency		Middle Frequency		Highest Frequency	
Channel	Frequency (MHz)	Channel	Frequency (MHz)	Channel	Frequency (MHz)
0	2402	19	2440	39	2480

## 4 FACILITIES AND ACCREDITATIONS

### 4.1 FACILITIES

All measurement facilities used to collect the measurement data are located at

No. 11, Wu Song Road, Dongcheng District, Dongguan, Guangdong Province, China 523117

The sites are constructed in conformance with the requirements of ANSI C63.4, ANSI C63.10 and CISPR Publication 32.

### 4.2 LABORATORY ACCREDITATIONS AND LISTINGS

#### Site Description

EMC Lab. : Accredited by ISED, October 31 2023  
CAB identifier: CN0126  
Company Number: 27767

Accredited by A2LA, October 31 2023  
The Certificate Registration Number is 6325.01

Accredited by FCC  
Designation Number: CN1287  
Test Firm Registration Number: 394054

Name of Firm : SLG-CPC Testlaboratory Co., Ltd.  
Site Location : No. 11, Wu Song Road, Dongcheng District, Dongguan,  
Guangdong Province, China 523117



## 5 TEST SYSTEM UNCERTAINTY

The following measurement uncertainty levels have been estimated for tests performed on the apparatus:

Parameter	Uncertainty
Radio Frequency	$\pm 1 \times 10^{-5}$
Maximum Peak Output Power Test	$\pm 1.0\%$
Conducted Emissions Test	$\pm 3.08\text{dB}$
Radiated Emission Test	$\pm 3.46\text{dB}$ (Below 30MHz)
	$\pm 4.60\text{dB}$ (Below 1GHz)
	$\pm 4.48\text{dB}$ (Above 1GHz)
Power Density	$\pm 0.9\%$
Occupied Bandwidth Test	$\pm 2.3\%$
Band Edge Test	$\pm 1.2\%$
Antenna Port Emission	$\pm 3\text{dB}$
Temperature	$\pm 3.2\%$
Humidity	$\pm 2.5\%$

Measurement Uncertainty for a level of Confidence of 95%

## 6 SETUP OF EQUIPMENT UNDER TEST

### 6.1 RADIO FREQUENCY TEST SETUP 1

The Bluetooth V5.3 DTS component's antenna port(s) of the EUT are connected to the measurement instrument per an appropriate attenuator. The EUT is controlled by PC/software to emit the specified signals for the purpose of measurements.



### 6.2 RADIO FREQUENCY TEST SETUP 2

The test site semi-anechoic chamber has met the requirement of NSA tolerance 4 dB according to the standards: ANSI C63.10. The test distance is 3m. The setup is according to the requirements in Section 13.1.4.1 of ANSI C63.10-2013 and CAN/CSA-CEI/IEC CISPR 32.

Below 30MHz:

The EUT is placed on a turntable 0.8 meters above the ground in the chamber, 3 meter away from the antenna (loop antenna). The Antenna should be positioned with its plane vertical at the specified distance from the EUT and rotated about its vertical axis for maximum response at each azimuth about the EUT. The center of the loop shall be 1 m above the ground. For certain applications, the loop antenna plane may also need to be positioned horizontally at the specified distance from the EUT.

30MHz-1GHz:

The EUT is placed on a turntable 0.8 meters above the ground in the chamber, 3 meter away from the antenna. The maximal emission value is acquired by adjusting the antenna height, polarisation and turntable azimuth. Normally, the height range of antenna is 1 m to 4 m, the azimuth range of turntable is 0° to 360°, and the receive antenna has two polarizations Vertical (V) and Horizontal (H).

Above 1GHz:

The EUT is placed on a turntable 1.5 meters above the ground in the chamber, 3 meter away from the antenna. The maximal emission value is acquired by adjusting the antenna height, polarisation and turntable azimuth. Normally, the height range of antenna is 1 m to 4 m, the azimuth range of turntable is 0° to 360°, and the receive antenna has two polarizations Vertical (V) and Horizontal (H).

(a) Radiated Emission Test Set-Up, Frequency Below 30MHz

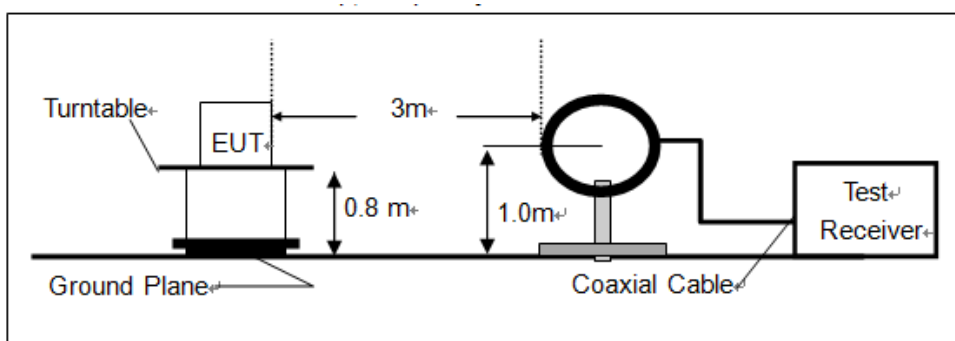

(b) Radiated Emission Test Set-Up, Frequency Below 1000MHz

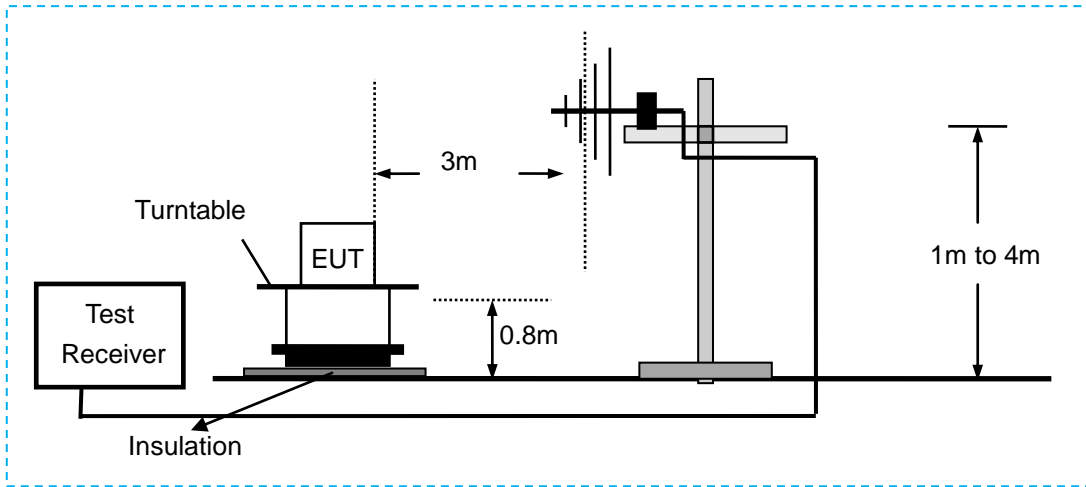

(c) Radiated Emission Test Set-Up, Frequency above 1000MHz

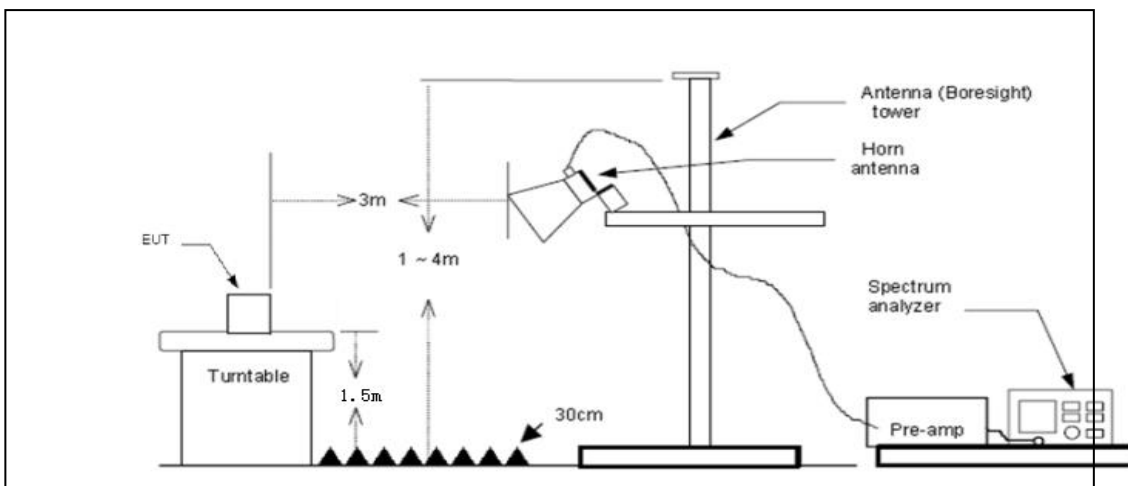

### 6.3 CONDUCTED EMISSION TEST SETUP

The mains cable of the EUT (maybe per AC/DC Adapter) must be connected to LISN. The LISN shall be placed 0.8 m from the boundary of EUT and bonded to a ground reference plane for LISN mounted on top of the ground reference plane. This distance is between the closest points of the LISN and the EUT. All other units of the EUT and associated equipment shall be at least 0.8m from the LISN.

Ground connections, where required for safety purposes, shall be connected to the reference ground point of the LISN and, where not otherwise provided or specified by the manufacturer, shall be of same length as the mains cable and run parallel to the mains connection at a separation distance of not more than 0.1 m.

According to the requirements in Section 13.1.4.1 of ANSI C63.10-2013 Conducted emissions from the EUT measured in the frequency range between 0.15 MHz and 30 MHz using CISPR Quasi-Peak and average detector mode.

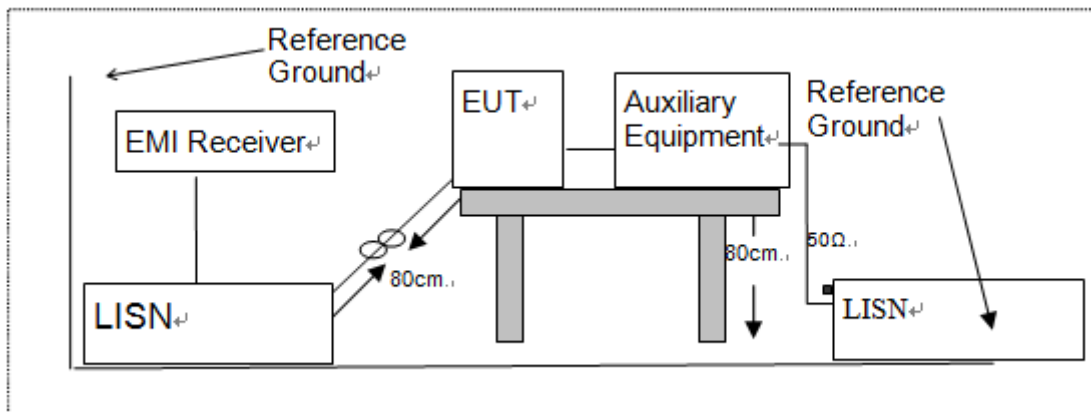

#### 6.4 BLOCK DIAGRAM CONFIGURATION OF TEST SYSTEM

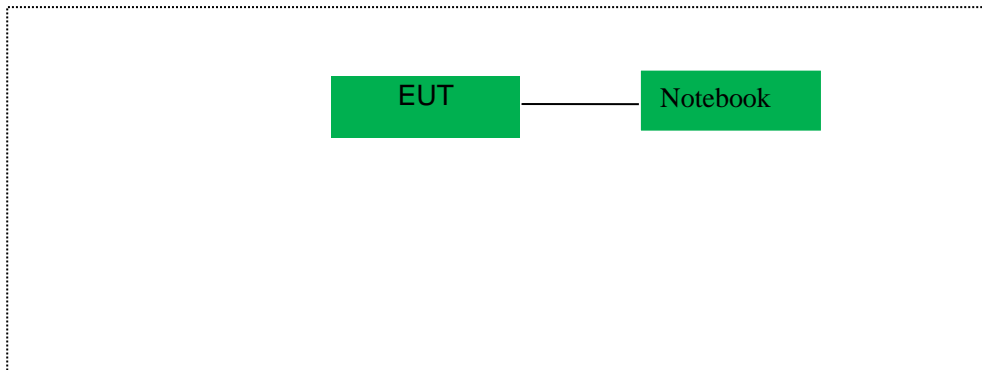

#### 6.5 SUPPORT EQUIPMENT

EUT Cable List and Details			
Cable Description	Length (m)	Shielded/Unshielded	With / Without Ferrite

Auxiliary Cable List and Details			
Cable Description	Length (m)	Shielded/Unshielded	With / Without Ferrite
/	/	/	/

Auxiliary Equipment List and Details			
Description	Manufacturer	Model	Serial Number
Notebook	Lenovo	MPNXB1505007	MP1XHYV7

#### Notes:

1. All the equipment/cables were placed in the worst-case configuration to maximize the emission during the test.
2. Grounding was established in accordance with the manufacturer's requirements and conditions for the intended use.

## 7 TEST REQUIREMENTS

### 7.1 DTS 6DB BANDWIDTH

#### 7.1.1 Applicable Standard

According to FCC Part 15.247(a)(2) and KDB 558074 D01 15.247 Meas Guidance v05r02

#### 7.1.2 Conformance Limit

The minimum -6 dB bandwidth shall be at least 500 kHz.

#### 7.1.3 Test Configuration

Test according to clause 6.1 radio frequency test setup 1

#### 7.1.4 Test Procedure

The EUT was operating in Bluetooth V5.3 DTS mode and controlled its channel. Printed out the test result from the spectrum by hard copy function.

The RF output of EUT was connected to the spectrum analyzer by RF cable and attenuator. The path loss was compensated to the results for each measurement.

Set to the maximum power setting and enable the EUT transmit continuously

Set RBW = 100 kHz.

Set the video bandwidth (VBW) =300 kHz.

Set Span=2 times OBW

Set Detector = Peak.

Set Trace mode = max hold.

Set Sweep = auto couple.

Allow the trace to stabilize.

Measure the maximum width of the emission that is constrained by the frequencies associated with the two outermost amplitude points (upper and lower frequencies) that are attenuated by 6 dB relative to the maximum level measured in the fundamental emission.

Measure and record the results in the test report.

### Test Results

Temperature:	26° C
Relative Humidity:	54%
ATM Pressure:	1011 mbar

Operation Mode	Channel Number	Channel Frequency (MHz)	Measurement Bandwidth (kHz)	Limit (kHz)	Verdict
Bluetooth V5.3 DTS (1Mbps)	0	2402	655	>500	PASS
	19	2440	655	>500	PASS
	39	2480	702	>500	PASS
Bluetooth V5.3 DTS (2Mbps)	0	2402	1394	>500	PASS
	19	2440	1350	>500	PASS
	39	2480	1385	>500	PASS

DTS (6dB) Bandwidth  
Bluetooth V5.3 DTS 1Mbps  
Channel 0: 2402MHz

Test Model

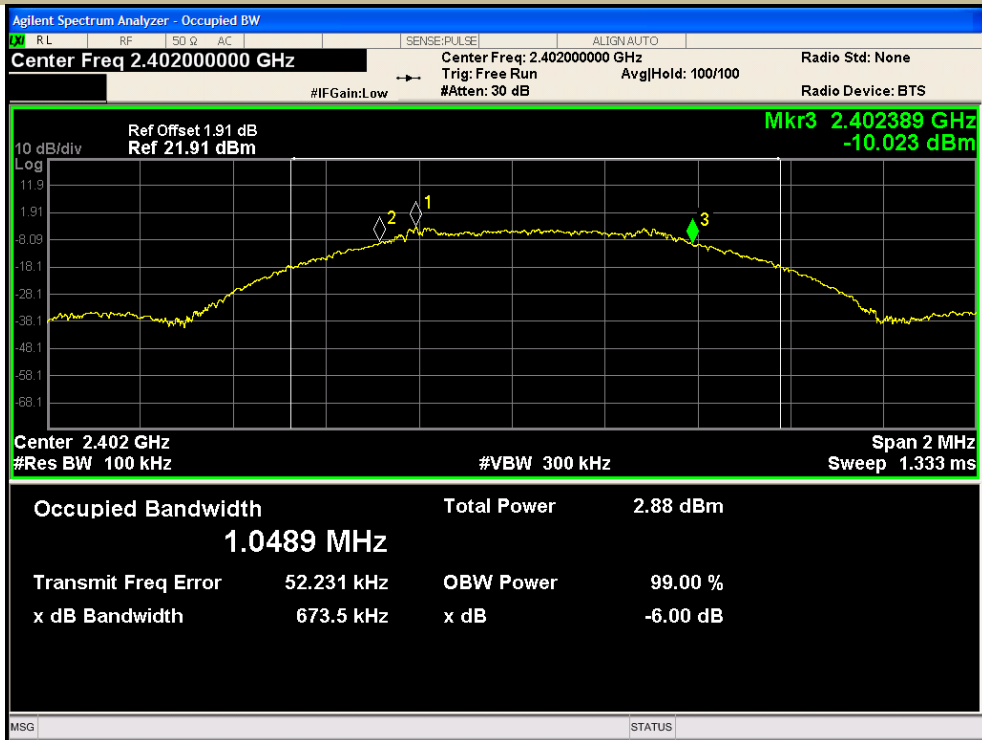

DTS (6dB) Bandwidth  
Bluetooth V5.3 DTS 1Mbps  
Channel 19: 2440MHz

Test Model

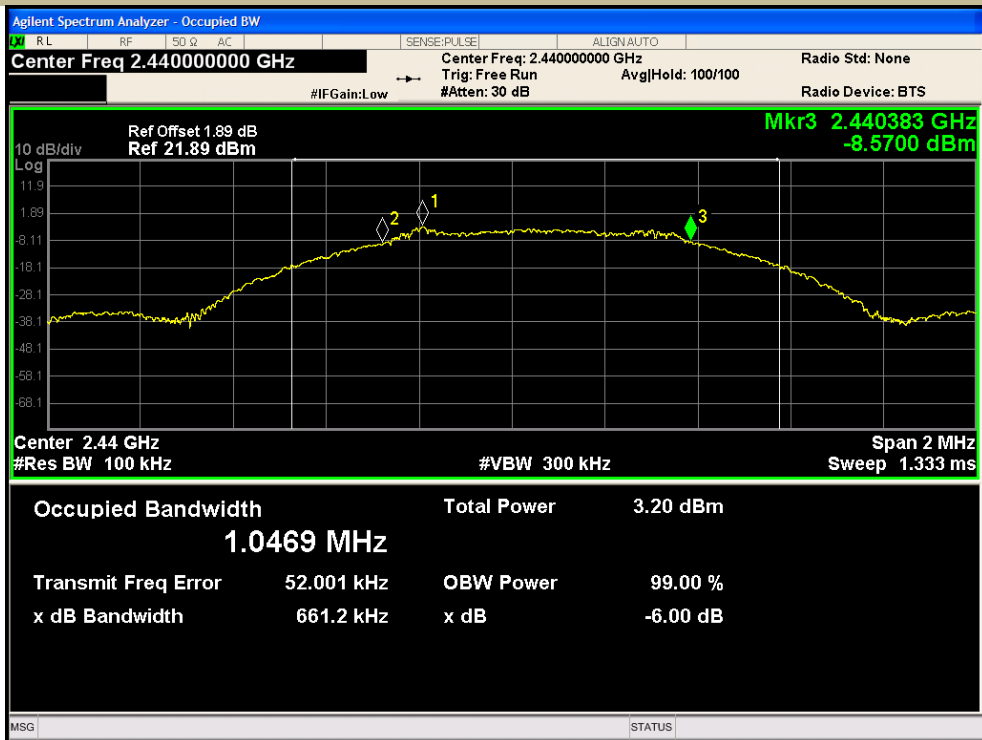

DTS (6dB) Bandwidth  
Bluetooth V5.3 DTS 1Mbps  
Channel 39: 2480MHz

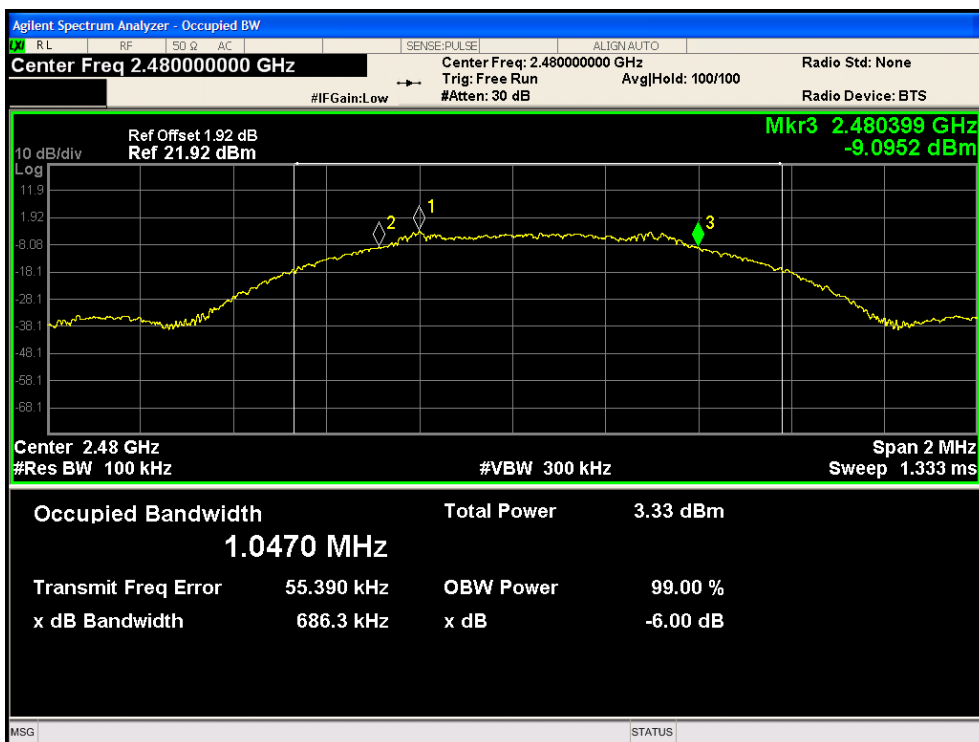

DTS (6dB) Bandwidth  
Bluetooth V5.3 DTS 2Mbps  
Channel 0: 2402MHz

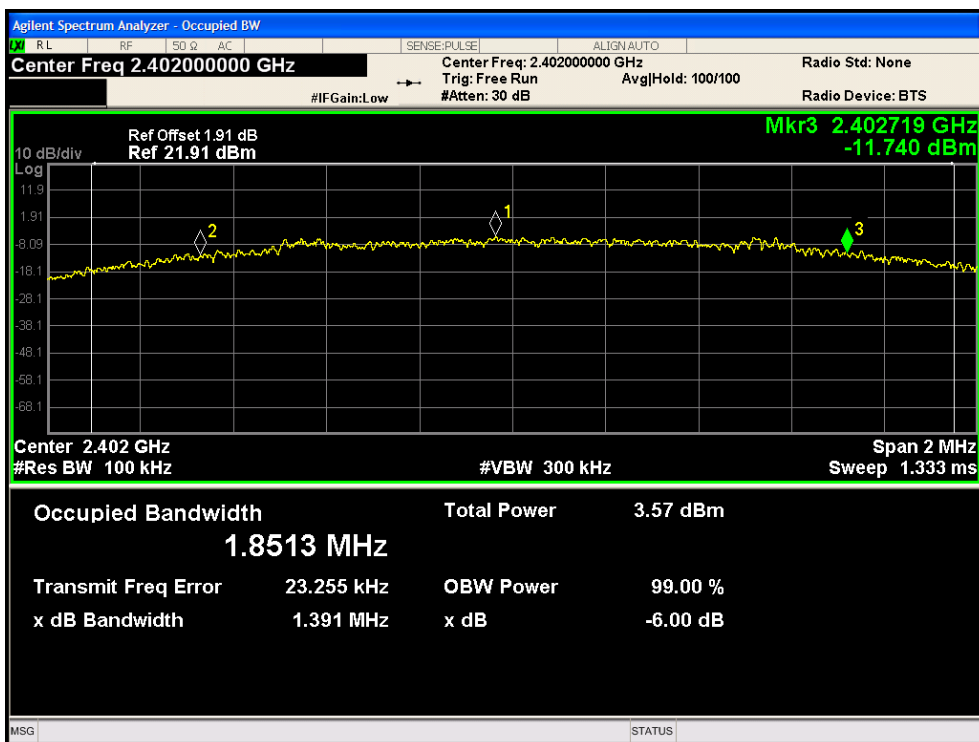



Test Model DTS (6dB) Bandwidth  
Bluetooth V5.3 DTS 2Mbps  
Channel 19: 2440MHz

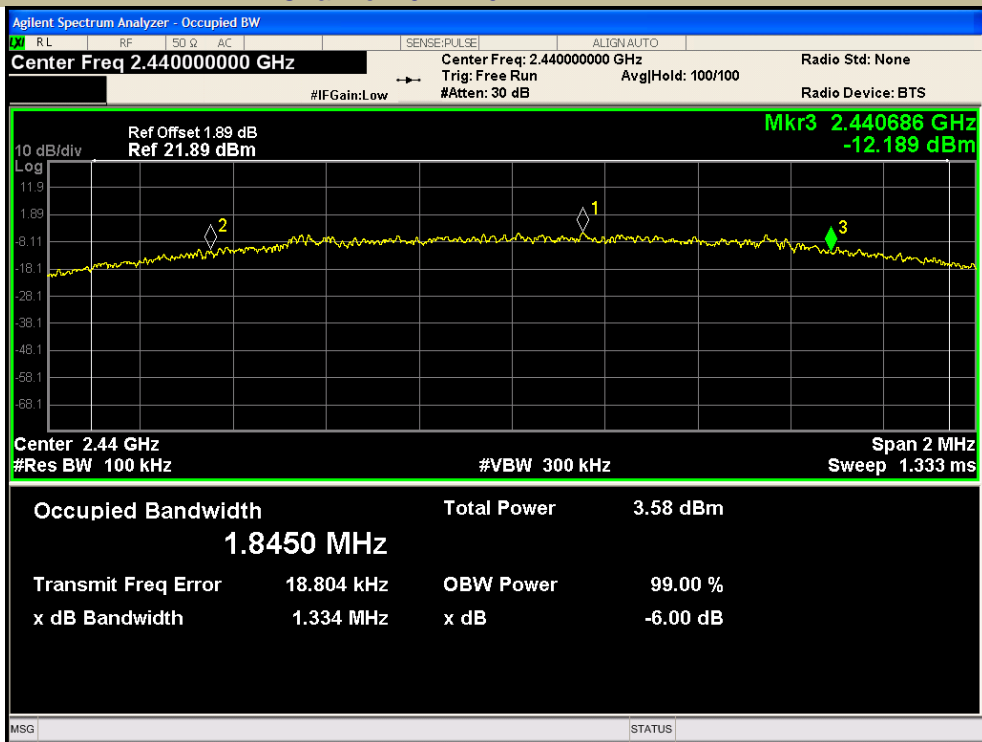

Test Model DTS (6dB) Bandwidth  
Bluetooth V5.3 DTS 2Mbps  
Channel 39: 2480MHz

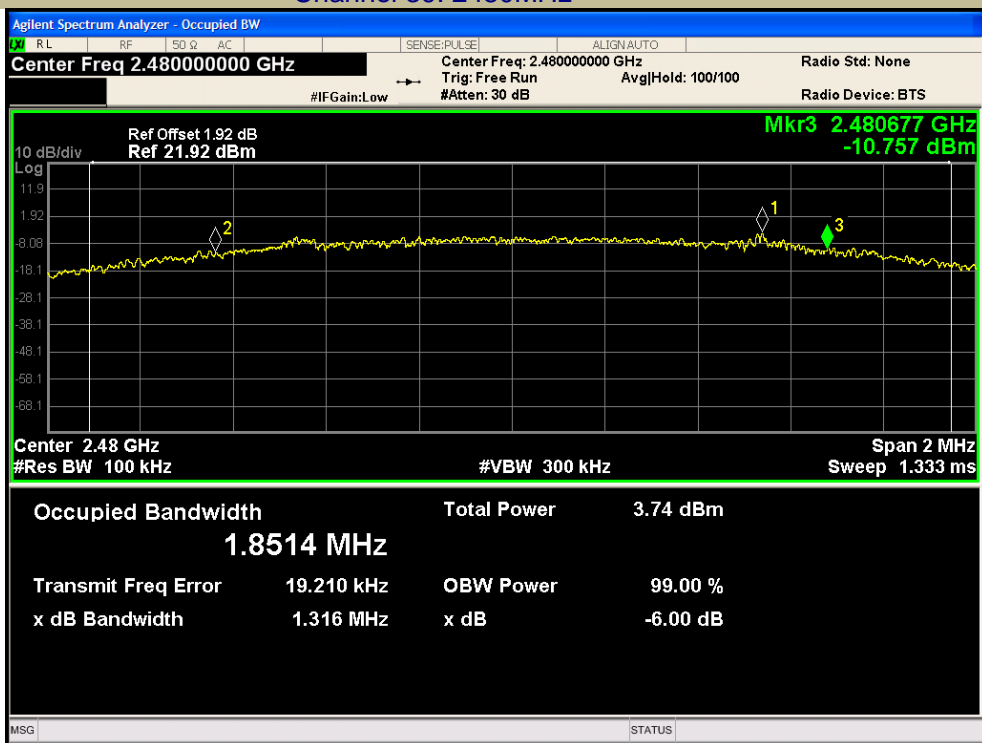

## 7.2 MAXIMUM PEAK CONDUCTED OUTPUT POWER

### 7.2.1 Applicable Standard

According to FCC Part 15.247(b)(3) and KDB 558074 D01 15.247 Meas Guidance v05r02

### 7.2.2 Conformance Limit

The maximum peak conducted output power of the intentional radiator for systems using digital modulation in the 2400 - 2483.5 MHz bands shall not exceed: 1 Watt (30dBm).

### 7.2.3 Test Configuration

Test according to clause 6.1 radio frequency test setup 1

### 7.2.4 Test Procedure

#### ■ According to FCC Part 15.247(b)(3)

As an alternative to a peak power measurement, compliance with the one Watt limit can be based on a measurement of the maximum conducted output power. For smart system, Maximum Conducted Output Power is defined as the total transmit power delivered to all antennas and antenna elements averaged across all symbols in the signaling alphabet when the transmitter is operating at its maximum power control level. Power must be summed across all antennas and antenna elements. If multiple modes of operation are possible (e.g., alternative modulation methods), the maximum conducted output power is the highest total transmit power occurring in any mode.

Set the RBW  $\cong$  DTS bandwidth.

Set VBW = 3\*RBW

Set the span  $\cong$  3\*RBW

Set Sweep time = auto couple.

Set Detector = peak.

Set Trace mode = max hold.

Allow trace to fully stabilize. Use peak marker function to determine the peak amplitude level.

#### ■ According to FCC Part 15.247(b)(4):

Conducted output power limit specified in paragraph (b) of this section is based on the use of antennas with directional gains that do not exceed 6 dBi. If transmitting antennas of directional gain greater than 6 dBi are used, the conducted output power from the intentional radiator shall be reduced below the stated values in paragraphs (b)(3) of this section, as appropriate, by the amount in dB that the directional gain of the antenna exceeds 6 dBi.

### Test Results

Temperature:	26° C
Relative Humidity:	54%
ATM Pressure:	1011 mbar

Operation Mode	Channel Number	Channel Frequency (MHz)	Measurement Level (dBm)	Limit (dBm)	Verdict
Bluetooth V5.3 DTS (1Mbps)	0	2402	-2.94	30	PASS
	19	2440	-2.67	30	PASS
	39	2480	-2.59	30	PASS
Bluetooth V5.3 DTS (2Mbps)	0	2402	-3.00	30	PASS
	19	2440	-2.92	30	PASS
	39	2480	-2.75	30	PASS

Test Model	Maximum Conducted Output Power	
	Bluetooth V5.3 DTS (1Mbps)	
	Channel 0: 2402MHz	GFSK modulation

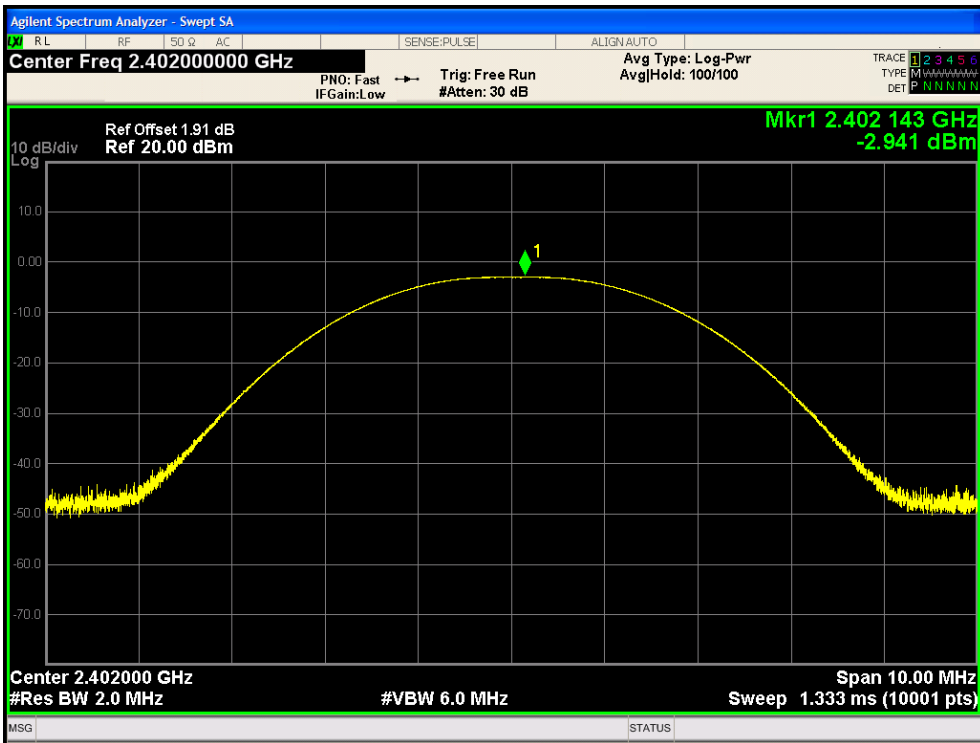

Test Model	Maximum Conducted Output Power	
	Bluetooth V5.3 DTS (1Mbps)	
	Channel 19: 2440MHz	GFSK modulation

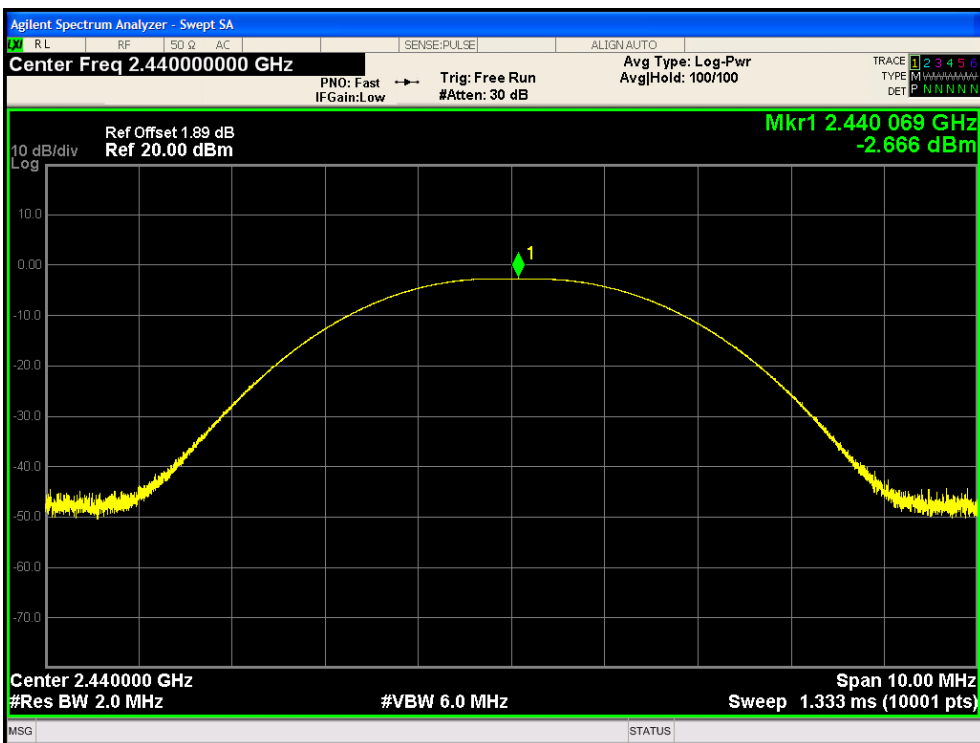

Test Model	Maximum Conducted Output Power	
	Bluetooth V5.3 DTS (1Mbps)	
	Channel 39: 2480MHz	GFSK modulation

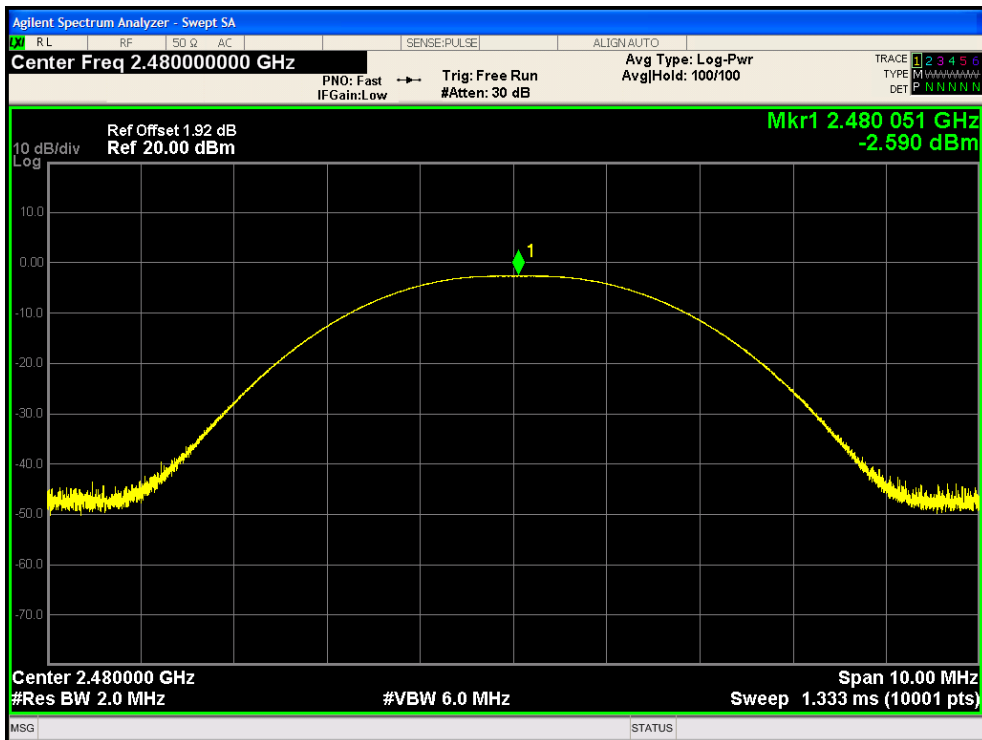

Test Model	Maximum Conducted Output Power	
	Bluetooth V5.3 DTS (2Mbps)	
	Channel 0: 2402MHz	GFSK modulation

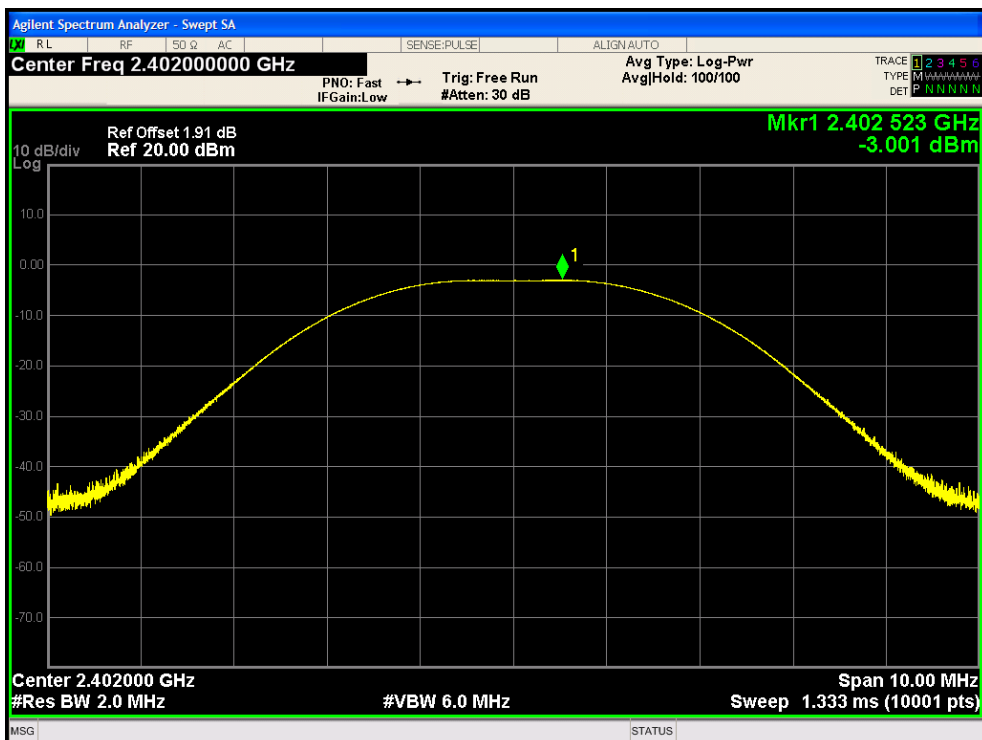

Test Model	Maximum Conducted Output Power	
	Bluetooth V5.3 DTS (2Mbps)	
	Channel 19: 2440MHz	GFSK modulation

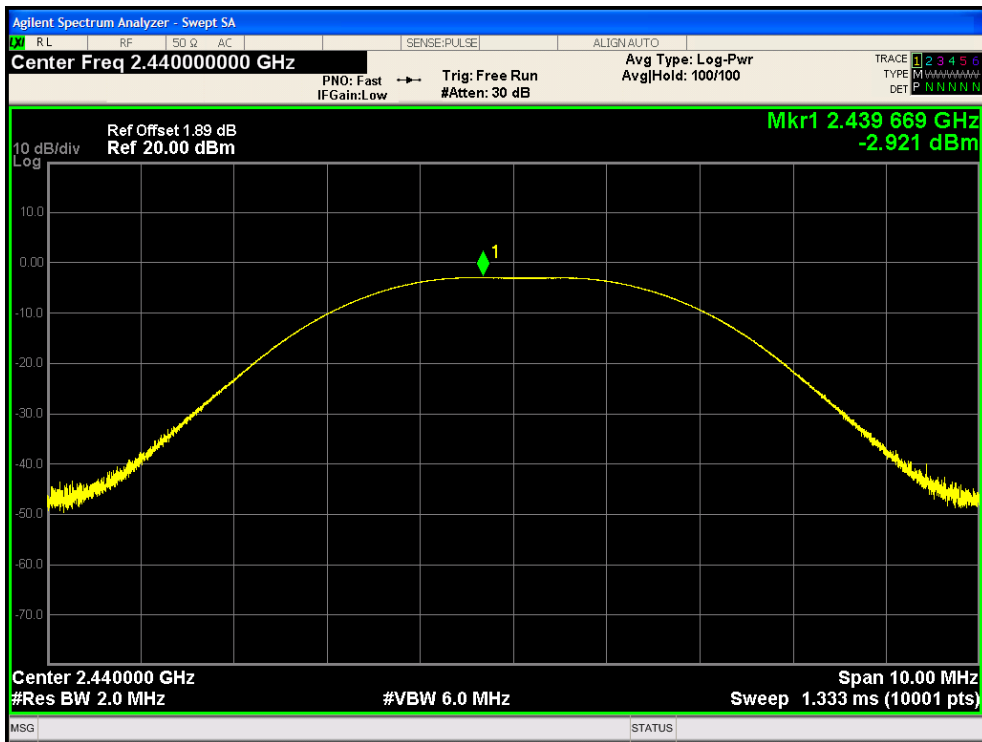

Test Model	Maximum Conducted Output Power	
	Bluetooth V5.3 DTS (2Mbps)	
	Channel 39: 2480MHz	GFSK modulation

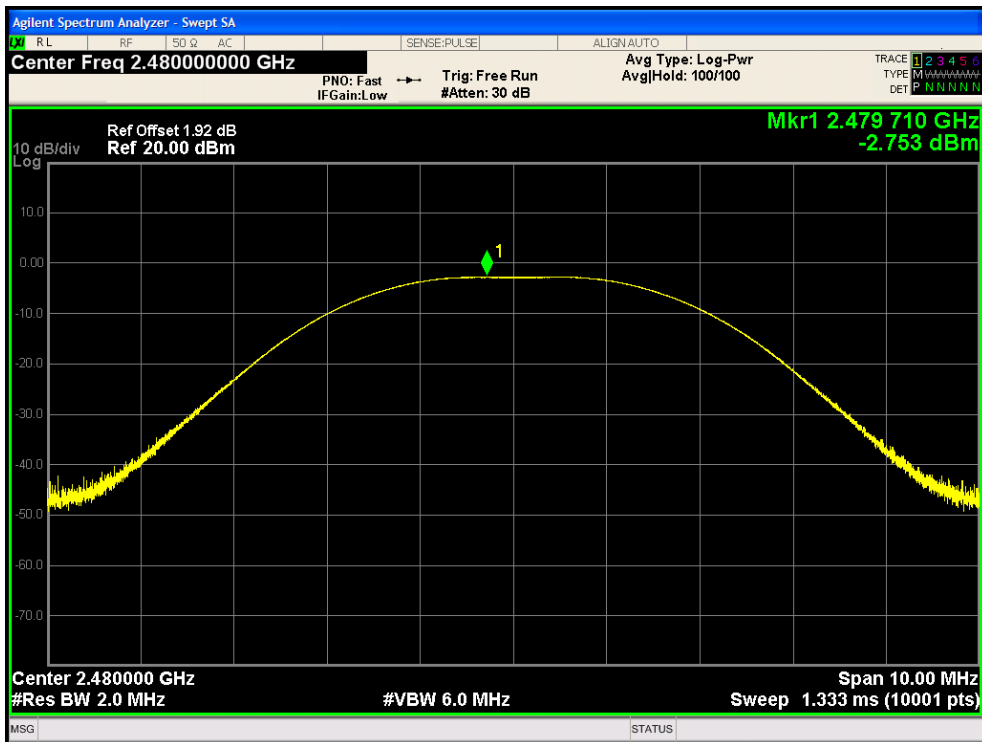

## 7.3 MAXIMUM POWER SPECTRAL DENSITY

### 7.3.1 Applicable Standard

According to FCC Part 15.247(e) and KDB 558074 D01 15.247 Meas Guidance v05r02

### 7.3.2 Conformance Limit

The transmitter power spectral density conducted from the transmitter to the antenna shall not be greater than 8 dBm in any 3 kHz band during any time interval of continuous transmission.

### 7.3.3 Test Configuration

Test according to clause 6.1 radio frequency test setup 1

### 7.3.4 Test Procedure

This procedure shall be used if maximum peak conducted output power was used to demonstrate compliance

The transmitter output (antenna port) was connected to the spectrum analyzer

Set analyzer center frequency to DTS channel center frequency.

Set the span to 1.5 times the DTS bandwidth.

Set the RBW to: 3 kHz

Set the VBW to: 10 kHz.

Set Detector = peak.

Set Sweep time = auto couple.

Set Trace mode = max hold.

Allow trace to fully stabilize.

Use the peak marker function to determine the maximum amplitude level within the RBW.

### 7.3.5 Test Results

Temperature:	26° C
Relative Humidity:	54%
ATM Pressure:	1011 mbar

Operation Mode	Channel Number	Channel Frequency (MHz)	Measurement Level (dBm/3kHz)	Limit (dBm/3kHz)	Verdict
Bluetooth V5.3 DTS (1Mbps)	0	2402	-15.09	<8	PASS
	19	2440	-14.29	<8	PASS
	39	2480	-14.42	<8	PASS
Bluetooth V5.3 DTS (2Mbps)	0	2402	-17.82	<8	PASS
	19	2440	-17.54	<8	PASS
	39	2480	-17.14	<8	PASS
Note: N/A					

Test Model Power Spectral Density  
Bluetooth V5.3 DTS (1Mbps)  
Channel 0: 2402MHz

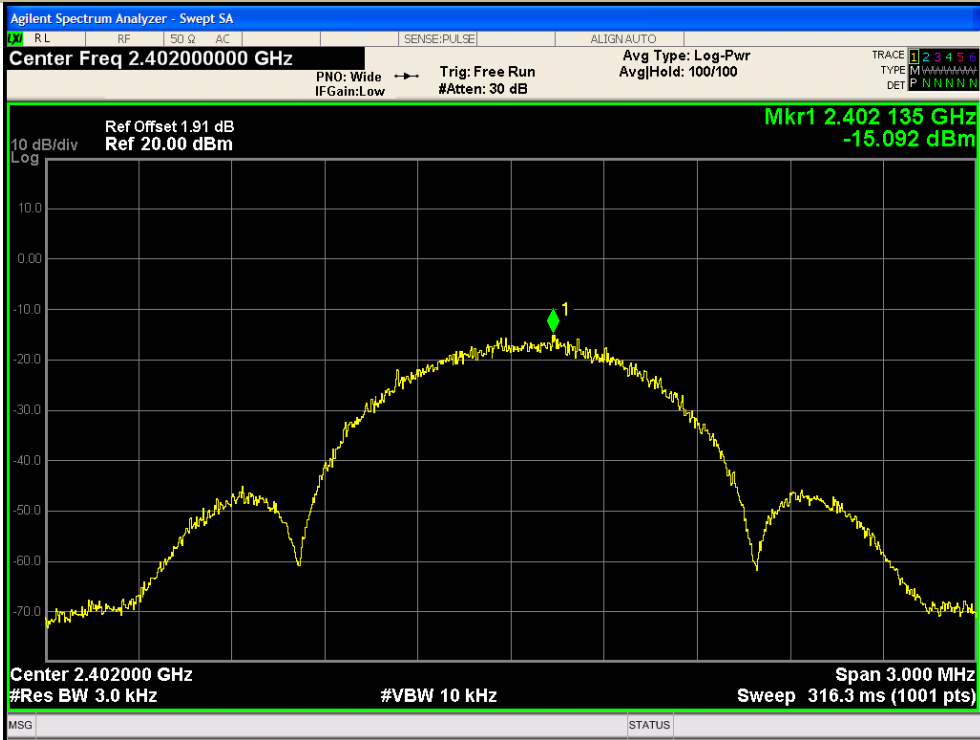

Test Model Power Spectral Density  
Bluetooth V5.3 DTS (1Mbps)  
Channel 19: 2440MHz

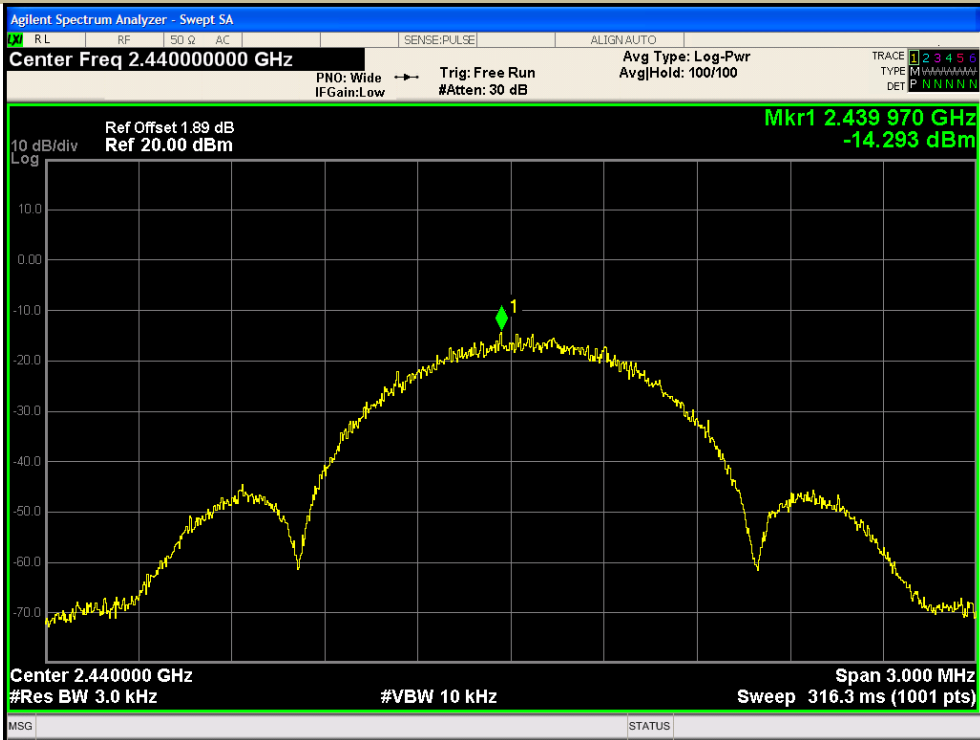

Test Model Power Spectral Density  
Bluetooth V5.3 DTS (1Mbps)  
Channel 39: 2480MHz

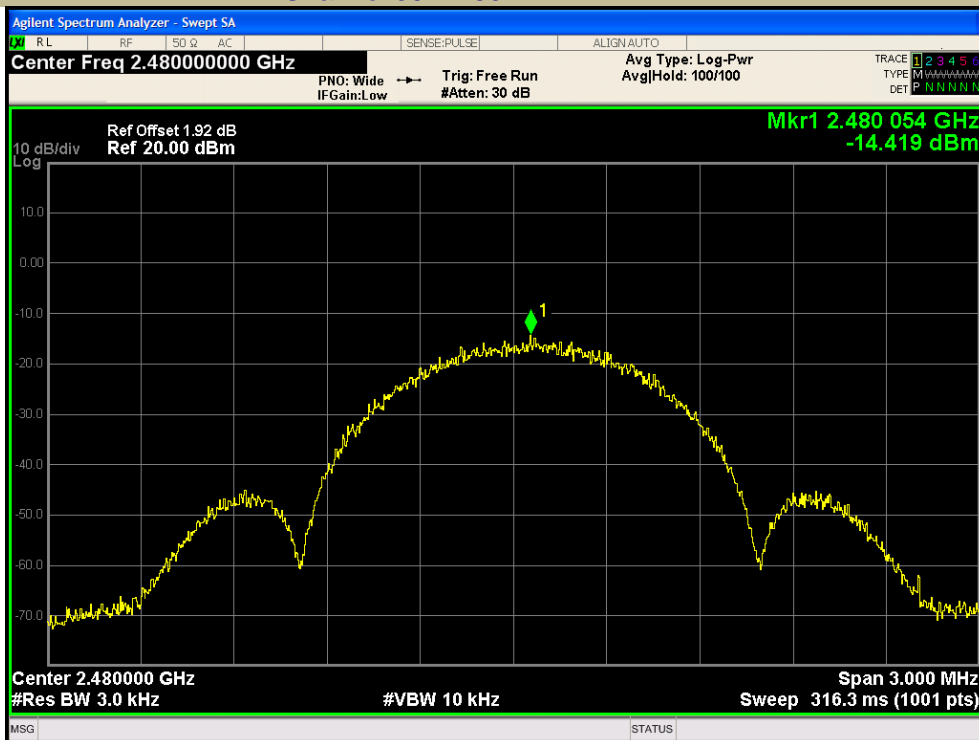

Test Model Power Spectral Density  
Bluetooth V5.3 DTS (2Mbps)  
Channel 0: 2402MHz

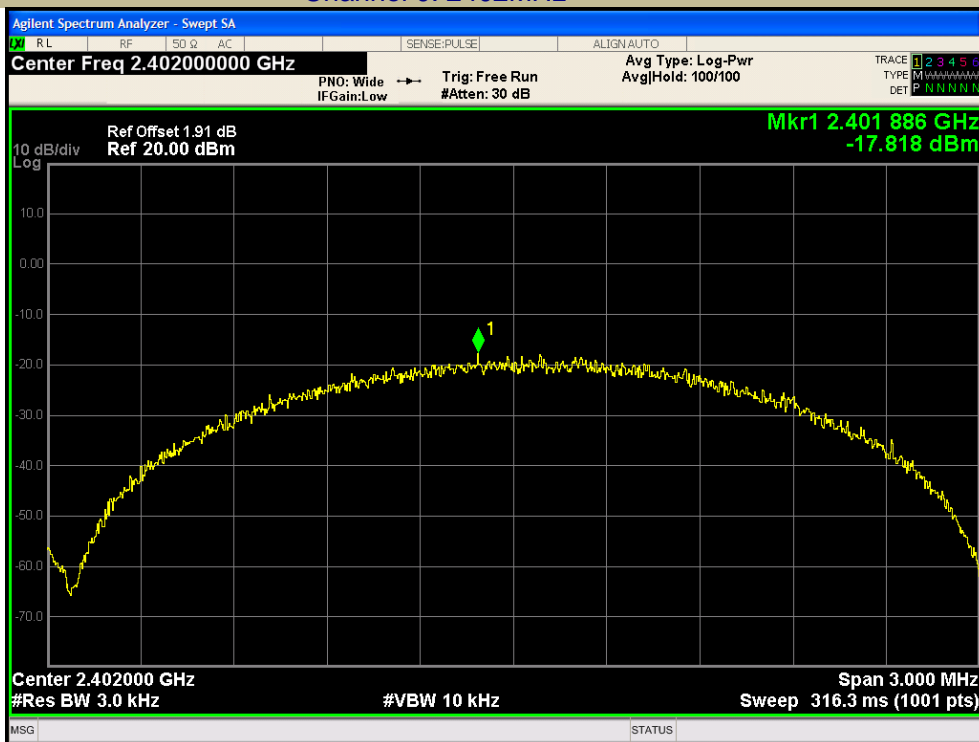



Test Model Power Spectral Density  
Bluetooth V5.3 DTS (2Mbps)  
Channel 19: 2440MHz

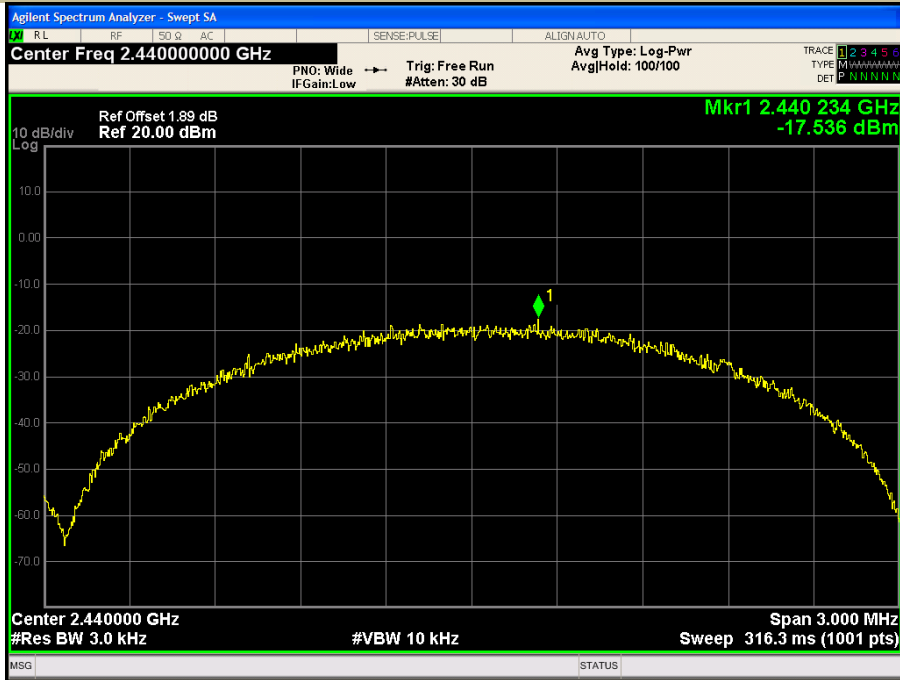

Test Model Power Spectral Density  
Bluetooth V5.3 DTS (2Mbps)  
Channel 39: 2480MHz

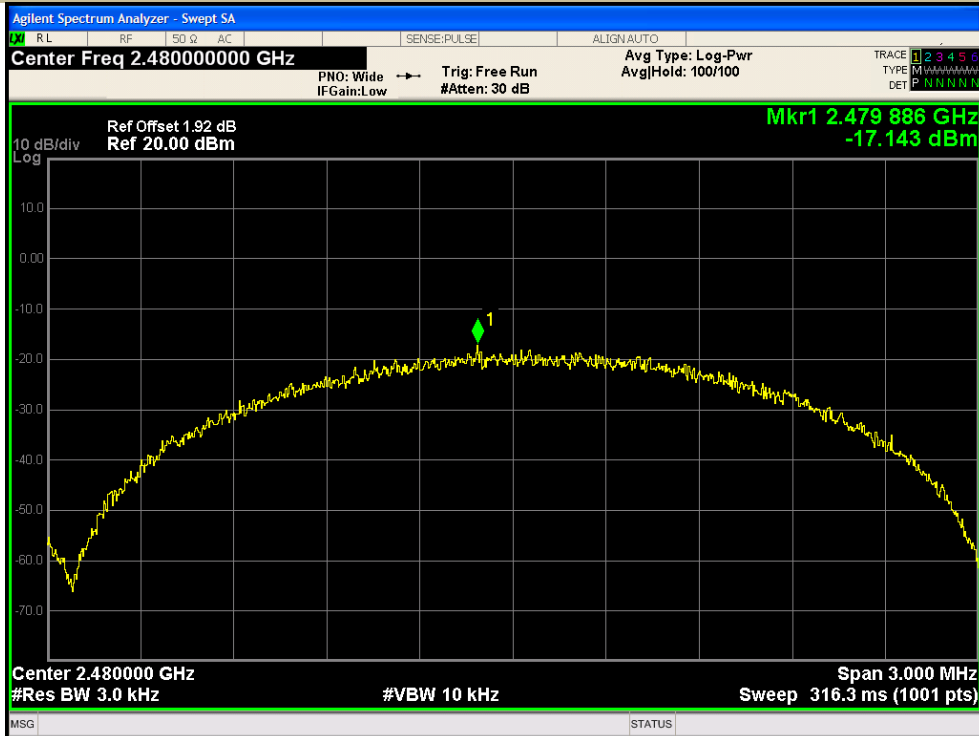

## 7.4 UNWANTED EMISSIONS IN NON-RESTRICTED FREQUENCY BANDS

### 7.4.1 Applicable Standard

According to FCC Part 15.247(d) and KDB 558074 D01 15.247 Meas Guidance v05r02

### 7.4.2 Conformance Limit

According to FCC Part 15.247(d):

In any 100 kHz bandwidth outside the frequency band in which the spread spectrum or digitally modulated intentional radiator is operating, the radio frequency power that is produced by the intentional radiator shall be at least 20 dB below that in the 100 kHz bandwidth within the band that contains the highest level of the desired power, based on either an RF conducted or a radiated measurement, provided the transmitter demonstrates compliance with the peak conducted power limits. If the transmitter complies with the conducted power limits based on the use of RMS averaging over a time interval, as permitted under paragraph (b)(3) of this section, the attenuation required under this paragraph shall be 30 dB instead of 20 dB.

### 7.4.3 Test Configuration

Test according to clause 6.1 radio frequency test setup 1

### 7.4.4 Test Procedure

The transmitter output (antenna port) was connected to the spectrum analyzer

#### ■ Reference level measurement

Establish a reference level by using the following procedure:

Set instrument center frequency to DTS channel center frequency.

Set the span to = 1.5 times the DTS bandwidth.

Set the RBW = 100 kHz.

Set the VBW  $\geq 3 \times$  RBW.

Set Detector = peak.

Set Sweep time = auto couple.

Set Trace mode = max hold.

Allow trace to fully stabilize.

Use the peak marker function to determine the maximum PSD level.

Note that the channel found to contain the maximum PSD level can be used to establish the reference level.

#### ■ Emission level measurement

Set the center frequency and span to encompass frequency range to be measured.

Set the RBW = 100 kHz.

Set the VBW = 300 kHz.

Set Detector = peak

Sweep time = auto couple.

Trace mode = max hold.

Allow trace to fully stabilize.

Use the peak marker function to determine the maximum amplitude level.

Ensure that the amplitude of all unwanted emissions outside of the authorized frequency band (excluding restricted frequency bands) are attenuated by at least the minimum requirements. Report the three highest emissions relative to the limit.

### 7.4.5 Test Results

Temperature:	26° C
Relative Humidity:	54%
ATM Pressure:	1011 mbar

Test Model PSD(Power Spectral Density) RBW=100kHz  
Bluetooth V5.3 DTS (1Mbps)  
Channel 0: 2402MHz

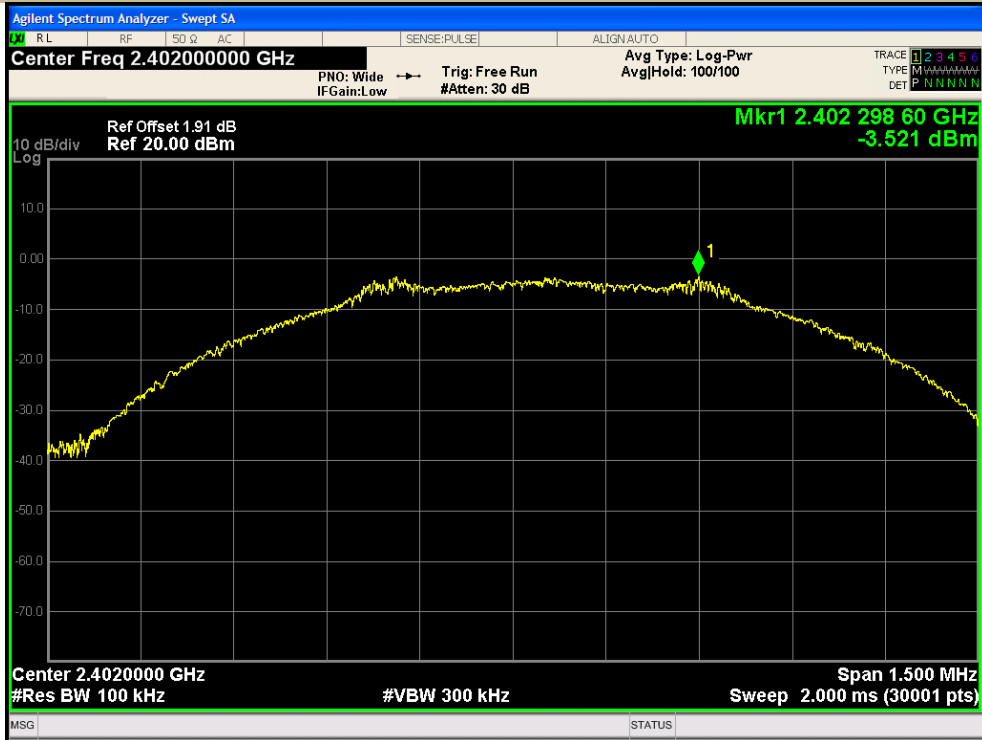

Test Model Unwanted Emissions in non-restricted frequency bands  
Bluetooth V5.3 DTS (1Mbps)  
Channel 0: 2402MHz

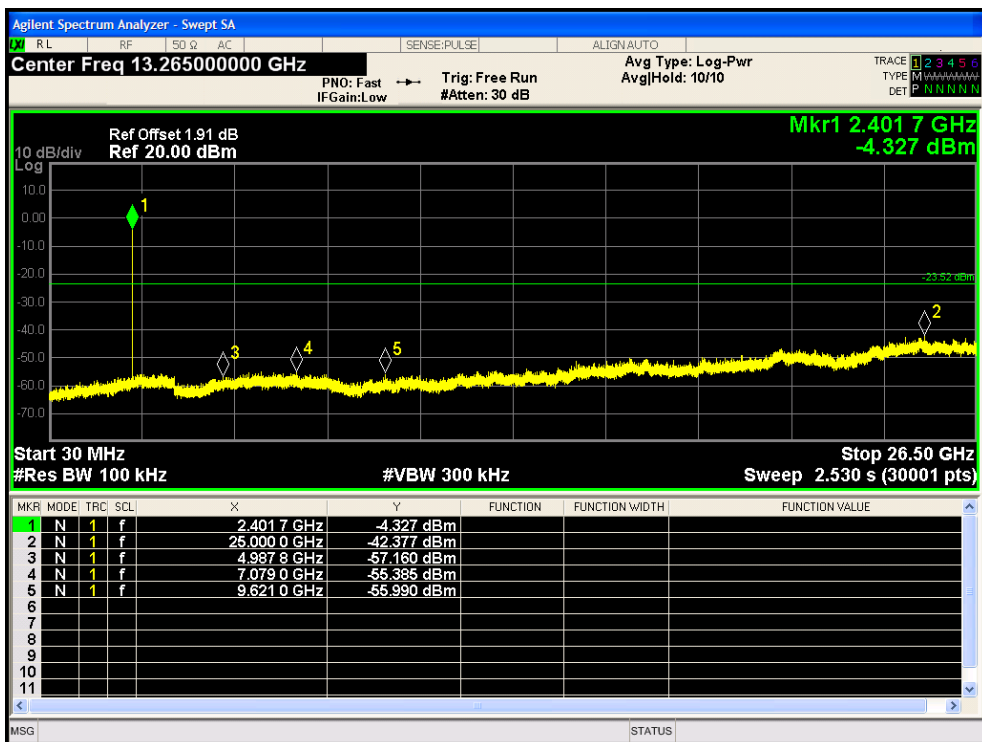

Band edge  
Bluetooth V5.3 DTS (1Mbps)  
Channel 0: 2402MHz

Test Model

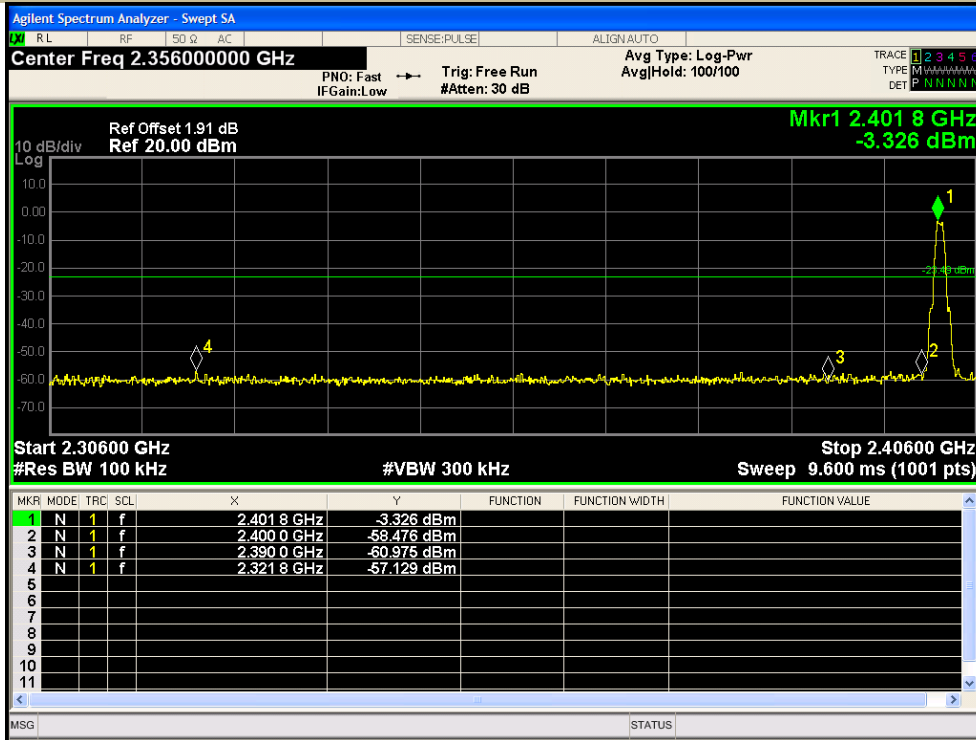

PSD(Power Spectral Density) RBW=100kHz  
Bluetooth V5.3 DTS (1Mbps)  
Channel 19: 2440MHz

Test Model

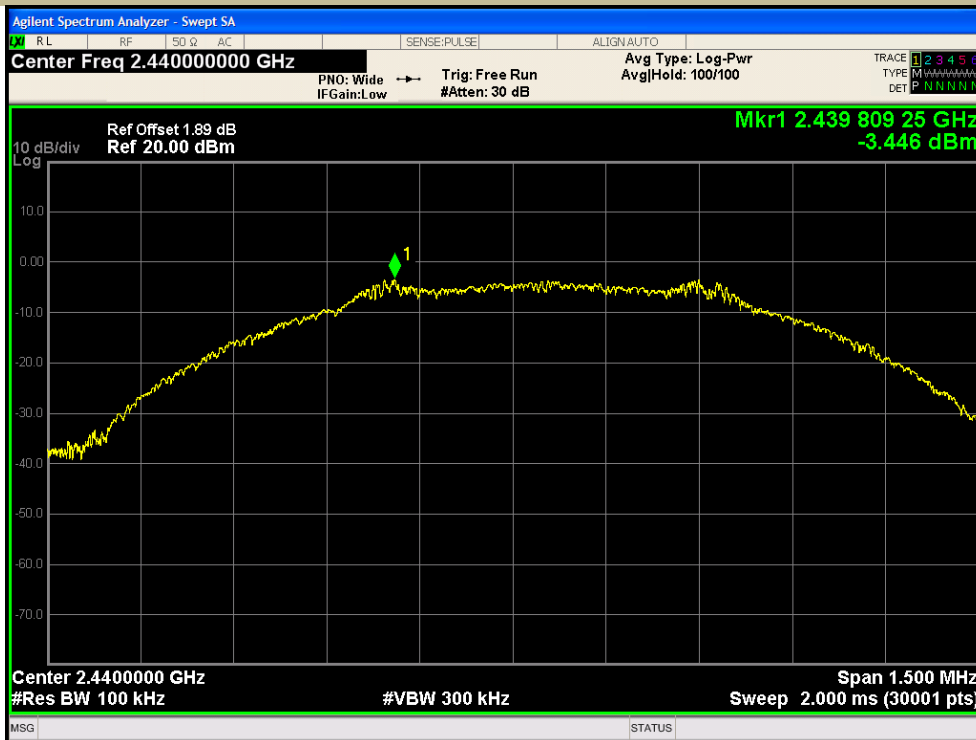

Unwanted Emissions In Non-Restricted Frequency Bands  
Bluetooth V5.3 DTS (1Mbps)  
Channel 19: 2440MHz

Test Model

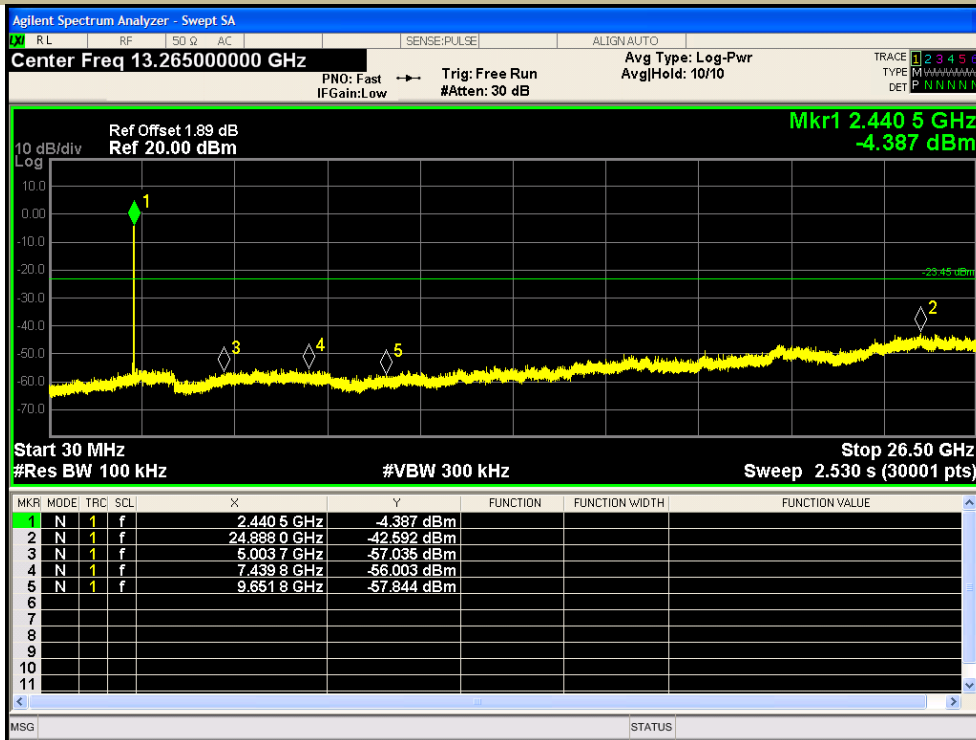

PSD(Power Spectral Density ) RBW=100kHz  
Bluetooth V5.3 DTS (1Mbps)  
Channel 19: 2480MHz

Test Model

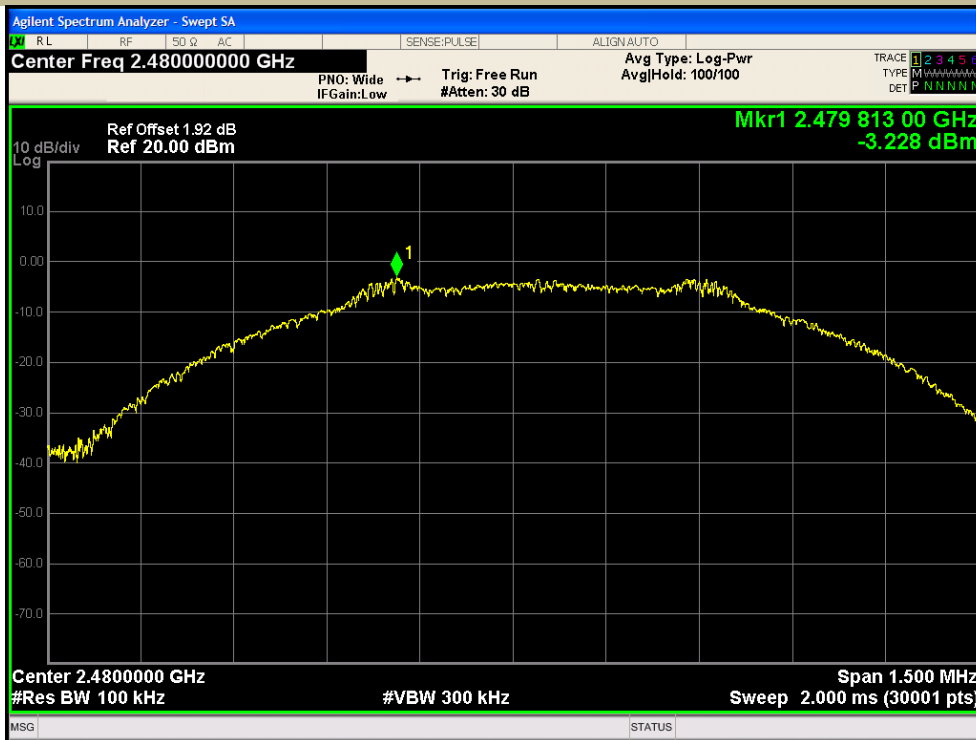

Unwanted Emissions In Non-Restricted Frequency Bands  
Bluetooth V5.3 DTS (1Mbps)  
Channel 39: 2480MHz

Test Model

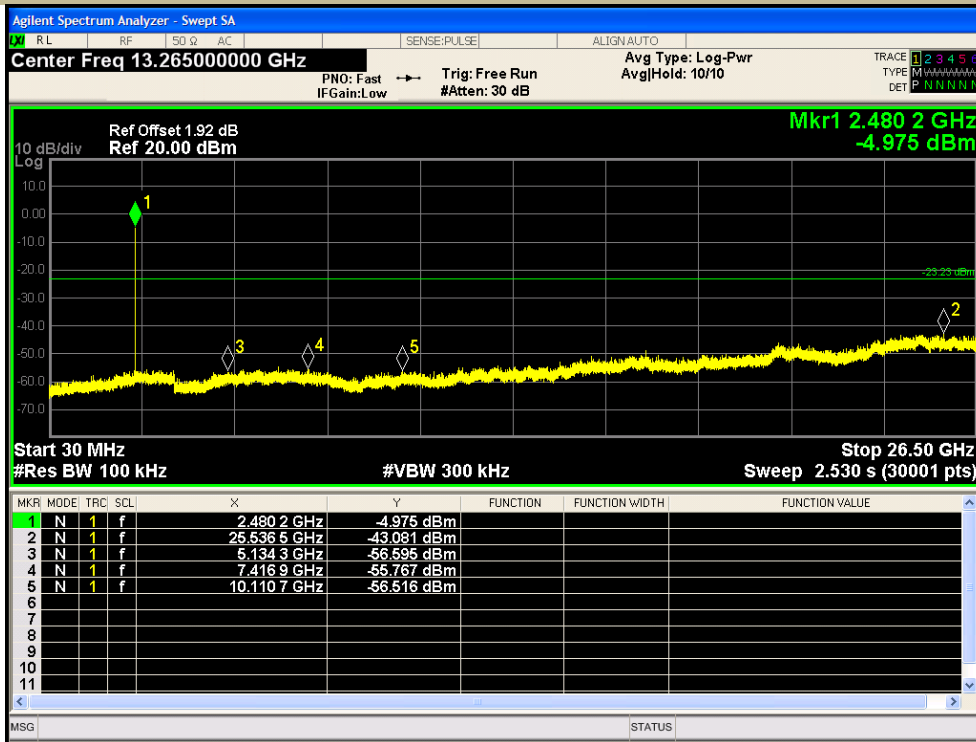

Band edge  
Bluetooth V5.3 DTS (1Mbps)  
Channel 39: 2480MHz

Test Model

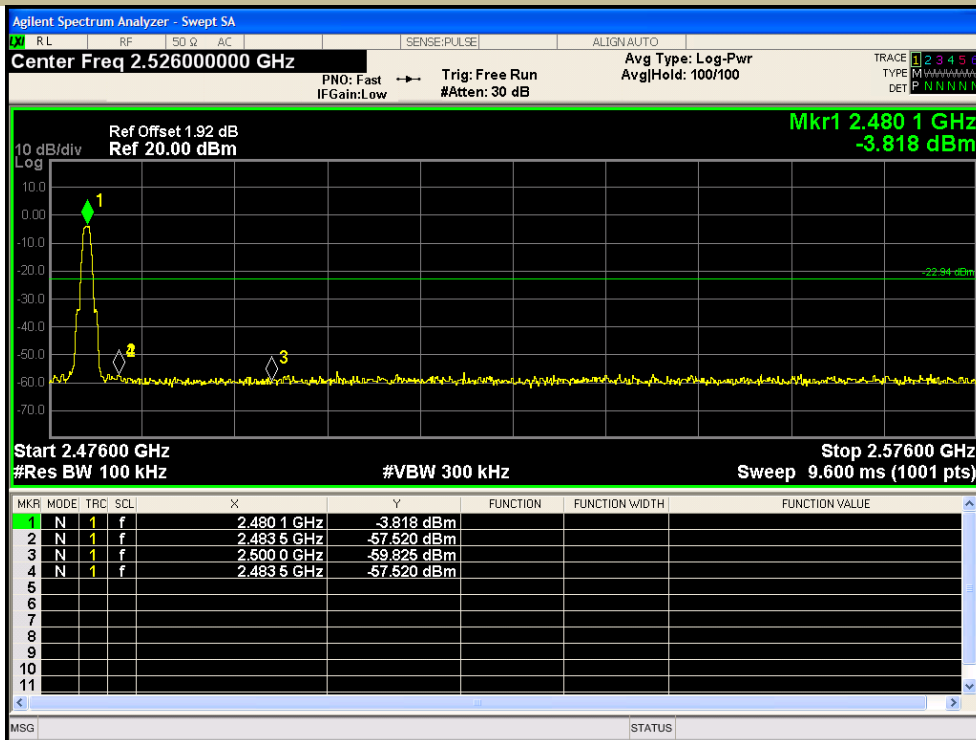

Test Model PSD(Power Spectral Density) RBW=100kHz  
Bluetooth V5.3 DTS (2Mbps)  
Channel 0: 2402MHz

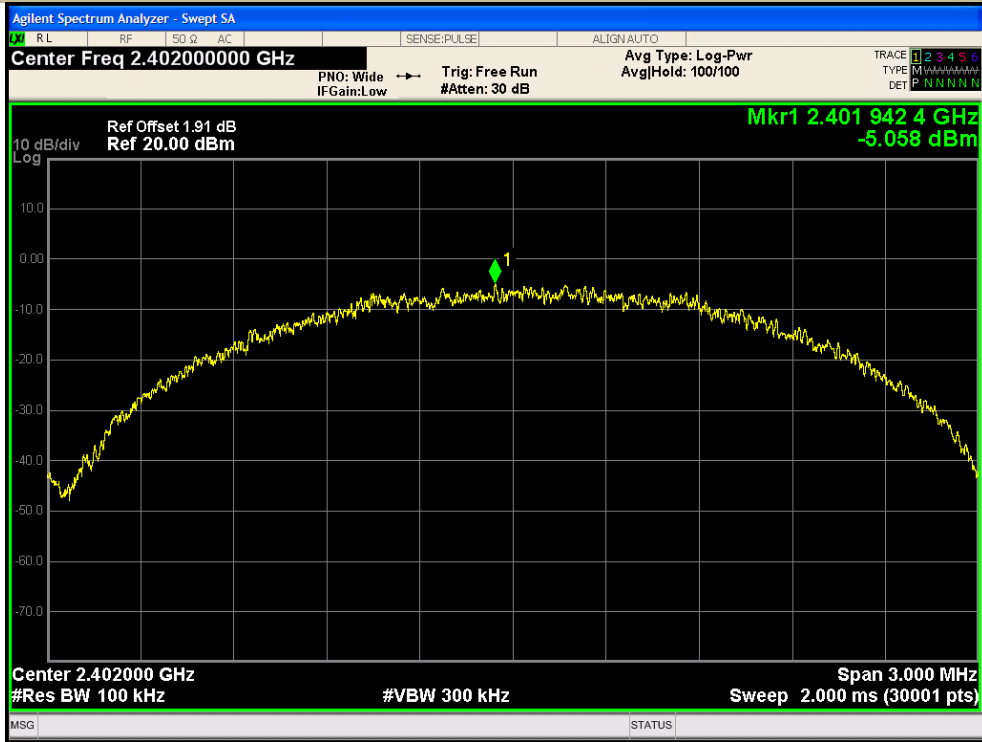

Test Model Unwanted Emissions in non-restricted frequency bands  
Bluetooth V5.3 DTS (2Mbps)  
Channel 0: 2402MHz

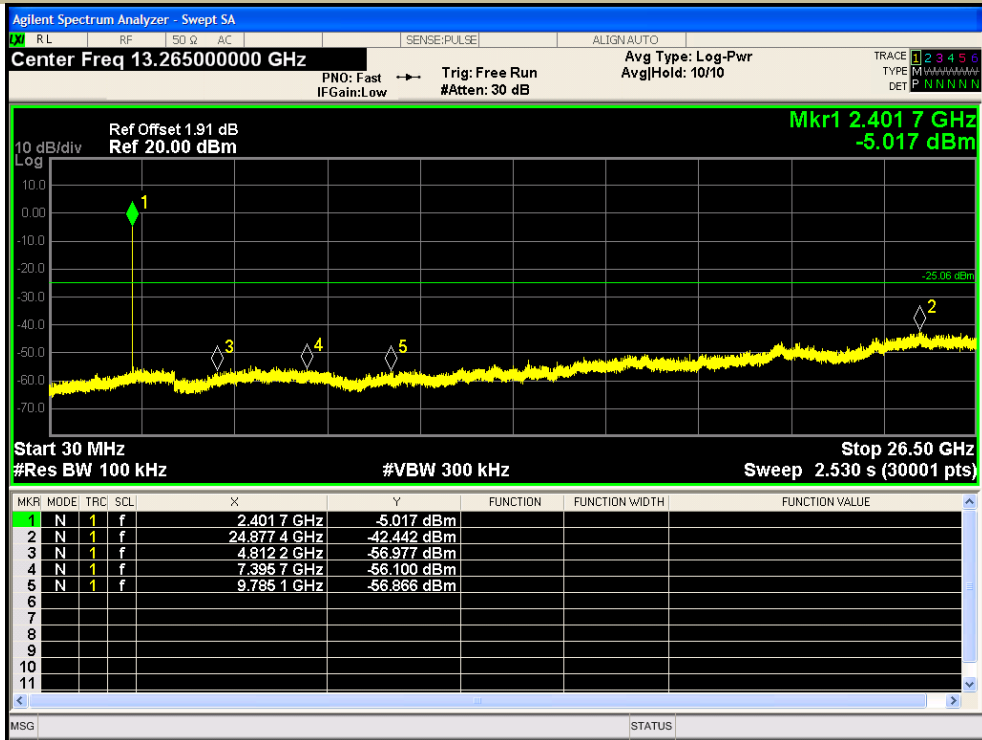

Test Model PSD(Power Spectral Density) RBW=100kHz  
Bluetooth V5.3 DTS (2Mbps)  
Channel 0: 2402MHz

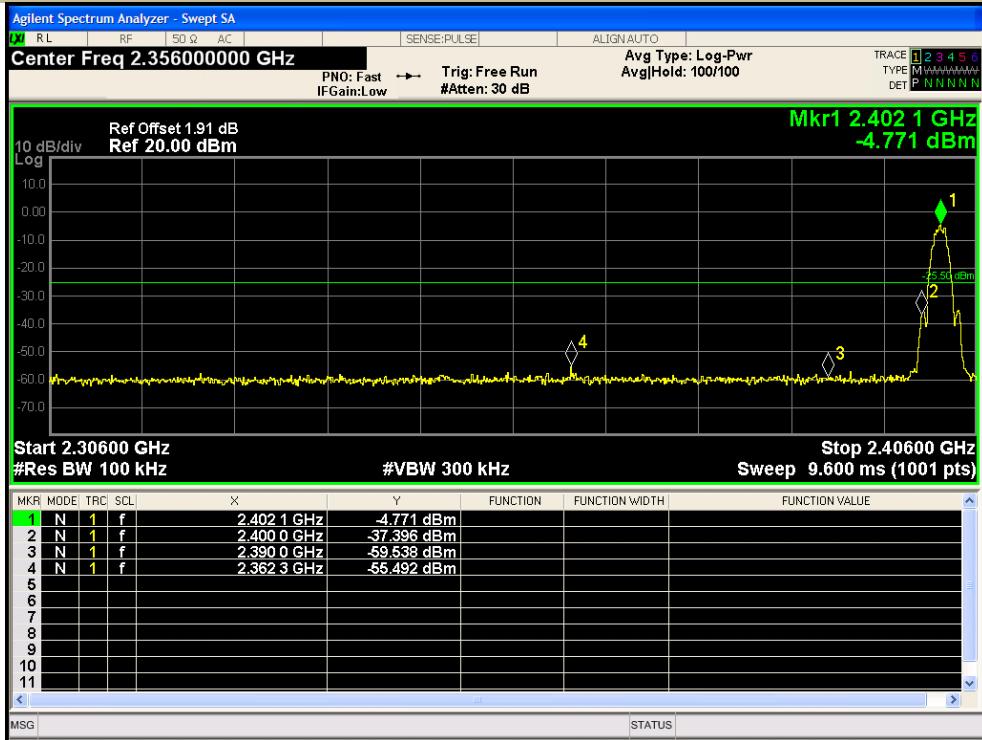

Test Model Unwanted Emissions in non-restricted frequency bands  
Bluetooth V5.3 DTS (2Mbps)  
Channel 0: 2440MHz

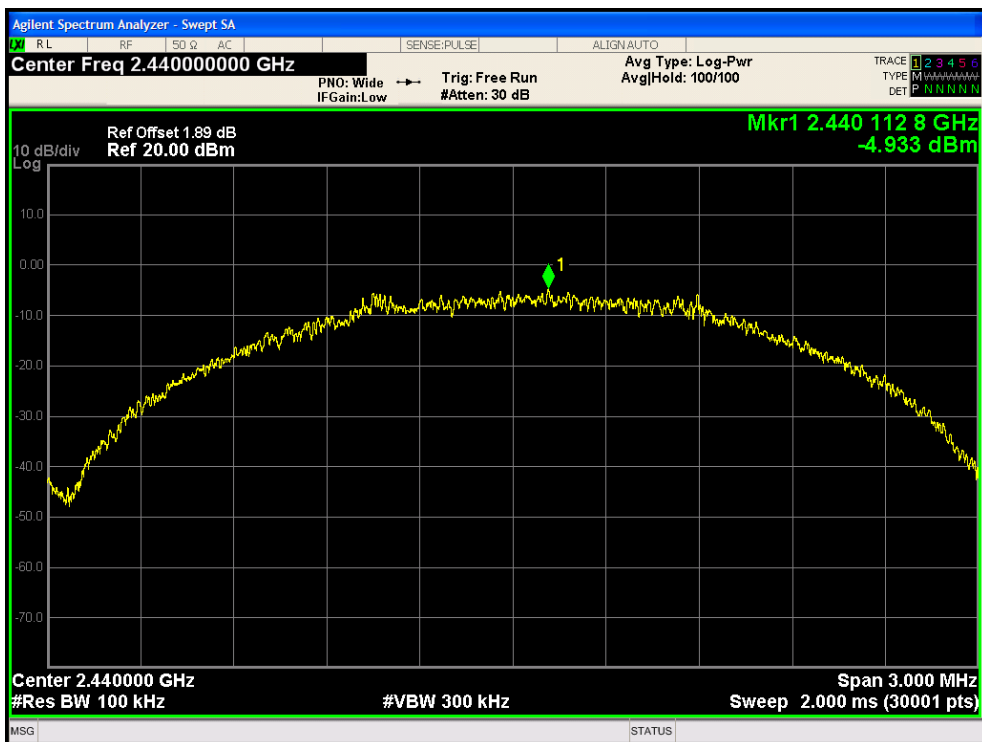



**Unwanted Emissions In Non-Restricted Frequency Bands**  
**Bluetooth V5.3 DTS (2Mbps)**  
**Channel 19: 2440MHz**

Test Model

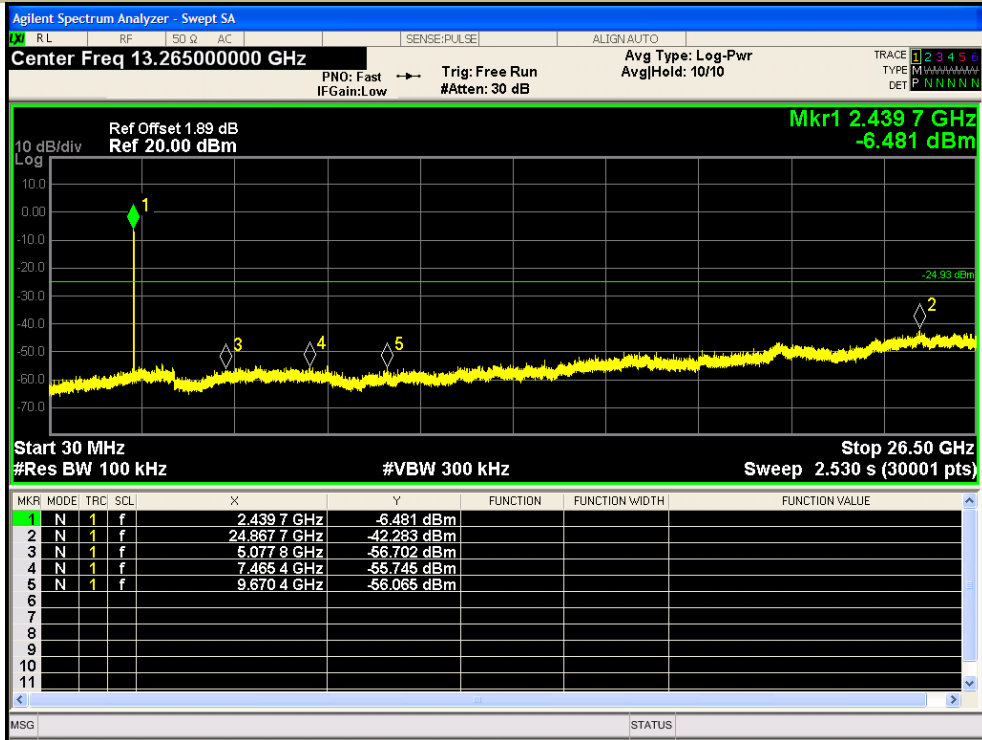

**PSD(Power Spectral Density ) RBW=100kHz**  
**Bluetooth V5.3 DTS (2Mbps)**  
**Channel 19: 2480MHz**

Test Model

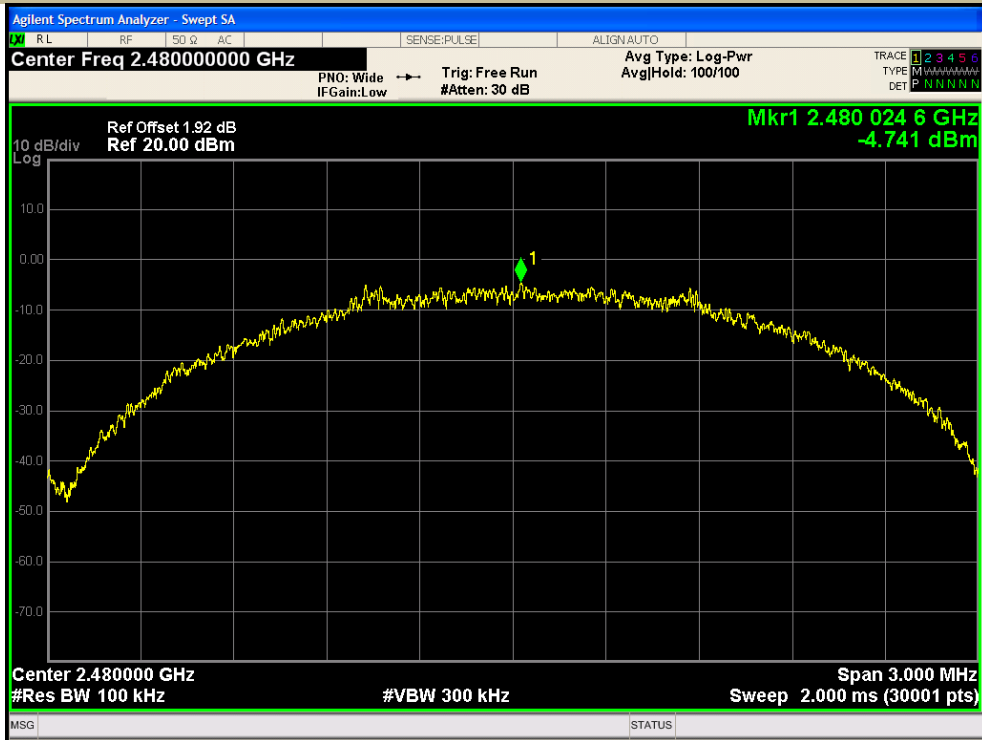

Unwanted Emissions In Non-Restricted Frequency Bands  
Bluetooth V5.3 DTS (2Mbps)  
Channel 39: 2480MHz

Test Model

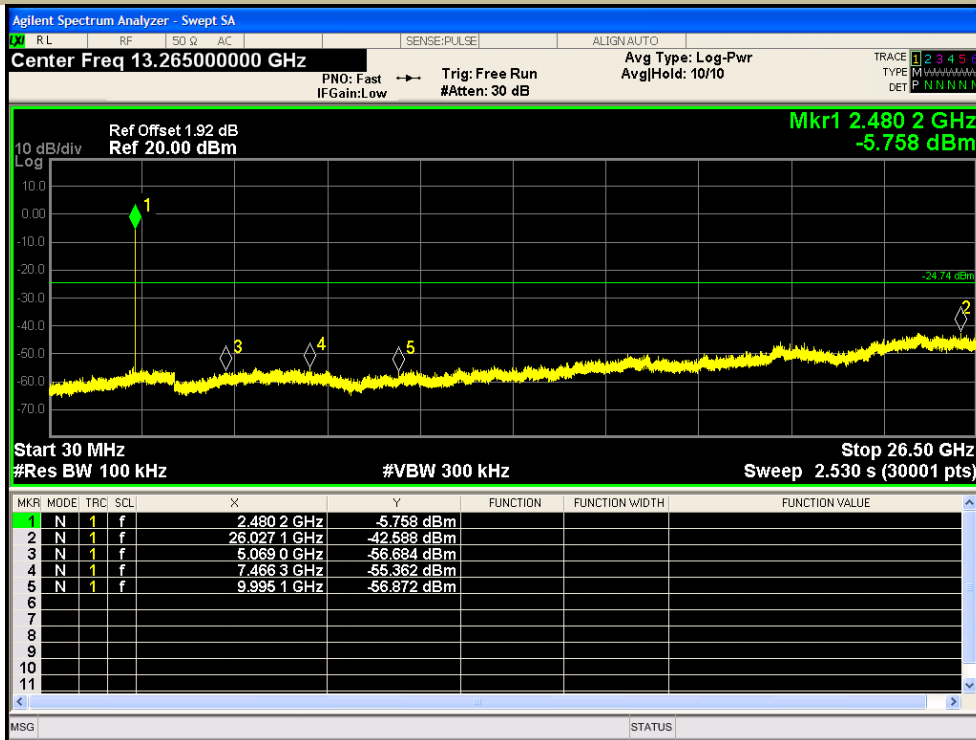

Band edge  
Bluetooth V5.3 DTS (2Mbps)  
Channel 39: 2480MHz

Test Model

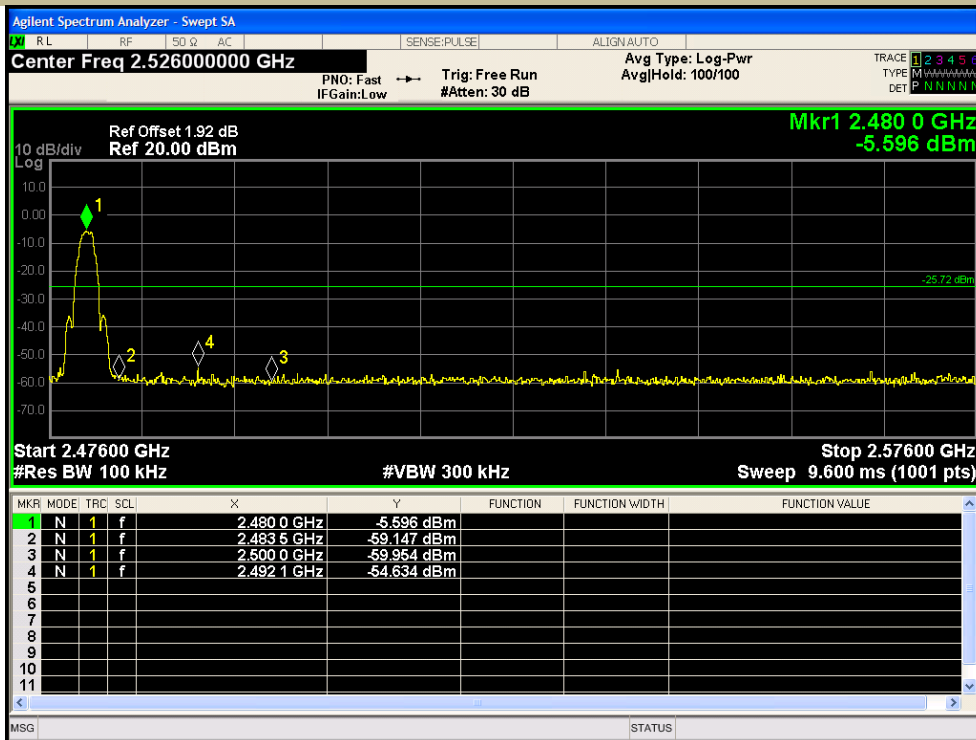

## 7.5 RADIATED SPURIOUS EMISSION

### 7.5.1 Applicable Standard

According to FCC Part 15.247(d) and 15.209 and KDB 558074 D01 15.247 Meas Guidance v05r02

### 7.5.2 Conformance Limit

According to FCC Part 15.247(d): radiated emissions which fall in the restricted bands, as defined in §15.205(a), must also comply with the radiated emission limits specified in §15.209(a) (see §15.205(c)).  
 According to FCC Part 15.205, Restricted bands

MHz	MHz	MHz	GHz
0.090-0.110	16.42-16.423	399.9-410	4.5-5.15
10.495-0.505	16.69475-16.69525	608-614	5.35-5.46
2.1735-2.1905	16.80425-16.80475	960-1240	7.25-7.75
4.125-4.128	25.5-25.67	1300-1427	8.025-8.5
4.17725-4.17775	37.5-38.25	1435-1626.5	9.0-9.2
4.20725-4.20775	73-74.6	1645.5-1646.5	9.3-9.5
6.215-6.218	74.8-75.2	1660-1710	10.6-12.7
6.26775-6.26825	123-138	2200-2300	14.47-14.5
8.291-8.294	149.9-150.05	2310-2390	15.35-16.2
8.362-8.366	156.52475-156.52525	2483.5-2500	17.7-21.4
8.37625-8.38675	156.7-156.9	2690-2900	22.01-23.12
8.41425-8.41475	162.0125-167.17	3260-3267	23.6-24.0
12.29-12.293	167.72-173.2	3332-3339	31.2-31.8
12.51975-12.52025	240-285	3345.8-3358	36.43-36.5
12.57675-12.57725	322-335.4	3600-4400	(2)
13.36-13.41			

According to FCC Part 15.205, the level of any transmitter spurious emission in Restricted bands shall not exceed the level of the emission specified in the following table

Restricted Frequency(MHz)	Field Strength ( $\mu\text{V}/\text{m}$ )	Field Strength ( $\text{dB}\mu\text{V}/\text{m}$ )	Measurement Distance
0.009-0.490	2400/F(KHz)	20 log ( $\mu\text{V}/\text{m}$ )	300
0.490-1.705	2400/F(KHz)	20 log ( $\mu\text{V}/\text{m}$ )	30
1.705-30	30	29.5	30
30-88	100	40	3
88-216	150	43.5	3
216-960	200	46	3
Above 960	500	54	3

### 7.5.3 Test Configuration

Test according to clause 6.2 radio frequency test setup 2

### 7.5.4 Test Procedure

This test is required for any spurious emission that falls in a Restricted Band, as defined in Section 15.205. It must be performed with the highest gain of each type of antenna proposed for use with the EUT. Use the following spectrum analyzer settings:

The EUT was placed on a turn table which is 0.8m above ground plane.

Maximum procedure was performed on the highest emissions to ensure EUT compliance.

Span = wide enough to fully capture the emission being measured

RBW = 1 MHz for  $f \geq 1$  GHz(1GHz to 25GHz), 100 kHz for  $f < 1$  GHz(30MHz to 1GHz)

VBW  $\geq$  RBW

Sweep = auto

Detector function = peak

Trace = max hold

Follow the guidelines in ANSI C63.10-2013 with respect to maximizing the emission by rotating the EUT, measuring the emission while the EUT is situated in three orthogonal planes (if appropriate), adjusting the measurement antenna height and polarization, etc. A pre-amp and a high pass filter are required for this test, in order to provide the measuring system with sufficient sensitivity. Allow the trace to stabilize. The peak reading of the emission, after being corrected by the antenna factor, cable loss, pre-amp gain, etc., is the peak field strength, which must comply with the limit specified in Section 15.35(b). Submit this data.

Now set the VBW to 10 Hz, while maintaining all of the other instrument settings. This peak level, once corrected, must comply with the limit specified in Section 15.209. If the dwell time per channel of the hopping signal is less than 100 ms, then the reading obtained with the 10 Hz VBW may be further adjusted by a “duty cycle correction factor”, derived from  $20\log(\text{dwell time}/100 \text{ ms})$ , in an effort to demonstrate compliance with the 15.209 limit. Submit this data.

Repeat above procedures until all frequency measured was complete.

### 7.5.5 Test Results

Temperature:	26° C
Relative Humidity:	54%
ATM Pressure:	1011 mbar

#### ■ Spurious Emission below 30MHz (9KHz to 30MHz)

Freq. (MHz)	Ant.Pol. H/V	Emission Level(dBuV/m)		Limit 3m(dBuV/m)		Over(dB)	
		PK	AV	PK	AV	PK	AV
--	--	--	--	--	--	--	--

Note: the amplitude of spurious emission that is attenuated by more than 20dB below the permissible limit has no need to be reported.

Distance extrapolation factor =  $40\log(\text{Specific distance}/\text{test distance})$  (dB);

Limit line = Specific limits(dBuV) + distance extrapolation factor

■ Spurious Emission Above 1GHz (1GHz to 25GHz)

Bluetooth V5.3 DTS mode have been tested, and the worst result was report as below:

Test mode: BLE 1Mbps Frequency: Channel 0: 2402MHz

Freq. (MHz)	Ant.Pol. H/V	Emission Level(dBuV/m)		Limit 3m(dBuV/m)		Over(dB)	
		PK	AV	PK	AV	PK	AV
4830.53	V	51.06	42.59	74	54	-22.94	-11.41
7195.64	V	46.78	39.30	74	54	-27.22	-14.70
7153.80	V	57.96	44.95	74	54	-16.04	-9.05
4778.34	H	46.73	38.56	74	54	-27.27	-15.44
7237.88	H	56.19	40.32	74	54	-17.81	-13.68
14414.12	H	50.03	38.15	74	54	-23.97	-15.85

Test mode: BLE 1Mbps Frequency: Channel 19: 2440MHz

Freq. (MHz)	Ant.Pol. H/V	Emission Level(dBuV/m)		Limit 3m(dBuV/m)		Over(dB)	
		PK	AV	PK	AV	PK	AV
4751.15	V	46.34	43.65	74	54	-27.66	-10.35
7245.28	V	47.20	43.74	74	54	-26.80	-10.26
12349.07	V	56.52	37.24	74	54	-17.48	-16.76
4751.06	H	59.98	43.88	74	54	-14.02	-10.12
71522.88	H	50.18	39.61	74	54	-23.82	-14.39
14159.24	H	55.42	39.17	74	54	-18.58	-14.83

Test mode: BLE 1Mbps Frequency: Channel 39: 2480MHz

Freq. (MHz)	Ant.Pol. H/V	Emission Level(dBuV/m)		Limit 3m(dBuV/m)		Over(dB)	
		PK	AV	PK	AV	PK	AV
4777.21	V	50.27	41.45	74	54	-23.73	-12.55
7247.00	V	48.49	41.57	74	54	-25.51	-12.43
12347.54	V	59.56	38.34	74	54	-14.44	-15.66
4798.22	H	51.32	40.57	74	54	-22.68	-13.43
7229.31	H	48.95	36.53	74	54	-25.05	-17.47
14839.86	H	54.94	37.59	74	54	-19.06	-16.41

- Note:** (1) All Readings are Peak Value (VBW=3MHz) and Peak Value (VBW=10Hz).  
 (2) Emission Level= Reading Level+Correct Factor +Cable Loss.  
 (3) Correct Factor= Ant\_F + Cab\_L - Preamp

■ Spurious Emission in Restricted Band 2310-2390MHz and 2483.5-2500MHz

Frequency (MHz)	Polarity	PK(dBuV/m) (VBW=3MHz)	Limit 3m (dBuV/m)	AV(dBuV/m) (VBW=10Hz)	Limit 3m (dBuV/m)
2350.16	H	41.37	74	31.67	54
2367.76	V	43.51	74	34.62	54

Frequency (MHz)	Polarity	PK(dBuV/m) (VBW=3MHz)	Limit 3m (dBuV/m)	AV(dBuV/m) (VBW=10Hz)	Limit 3m (dBuV/m)
2490.13	H	44.61	74	35.36	54
2491.42	V	46.29	74	37.94	54

- Note:** (1) All Readings are Peak Value (VBW=3MHz) and Peak Value (VBW=10Hz).  
 (2) Emission Level= Reading Level+Correct Factor +Cable Loss.  
 (3) Correct Factor= Ant\_F + Cab\_L - Preamp

All the modulation modes were tested, the data of the worst mode are described in the following table

Spurious Emission in Restricted Band 2310-2390MHz			
Test Model		Bluetooth V5.3 DTS	
		Channel 0: 2402MHz	
		H	
Model No.:	Y113S	Test Power :	DC 3.7V
Temperature:	26 °C	Humidity:	55 %

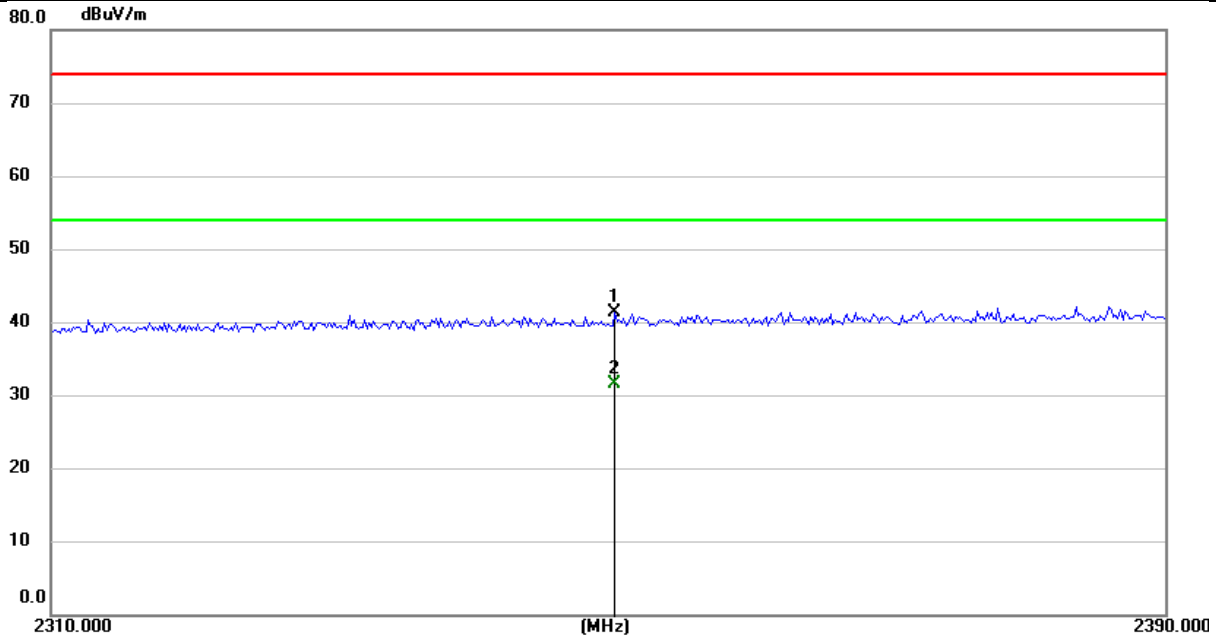

Spurious Emission in Restricted Band 2310-2390MHz			
Test Model		Bluetooth V5.3 DTS	
		Channel 0: 2402MHz	
		V	
Model No.:	Y113S	Test Power :	DC 3.7V
Temperature:	26 °C	Humidity:	55 %

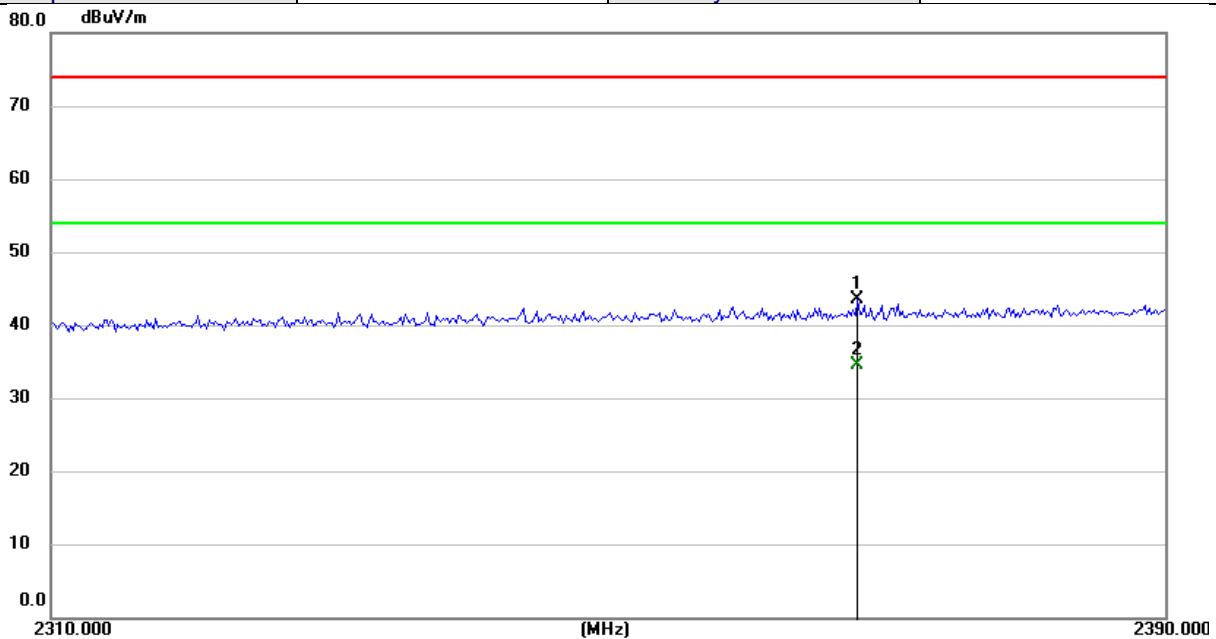

**Spurious Emission in Restricted Band 2483.5-2500MHz**  
**Bluetooth V5.3 DTS**  
**Channel 39: 2480MHz** H

Model No.:	Y113S	Test Power :	DC 3.7V
Temperature:	26 °C	Humidity:	55 %

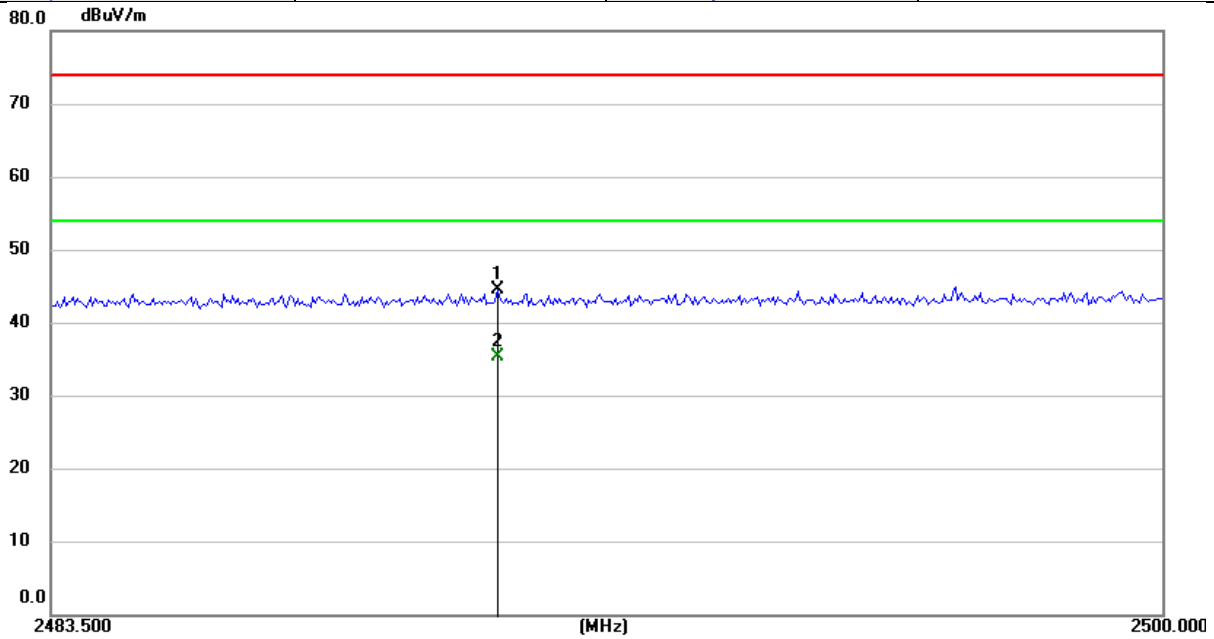

**Spurious Emission in Restricted Band 2483.5-2500MHz**  
**Bluetooth V5.3 DTS**  
**Channel 39: 2480MHz** V

Model No.:	Y113S	Test Power :	DC 3.7V
Temperature:	26 °C	Humidity:	55 %

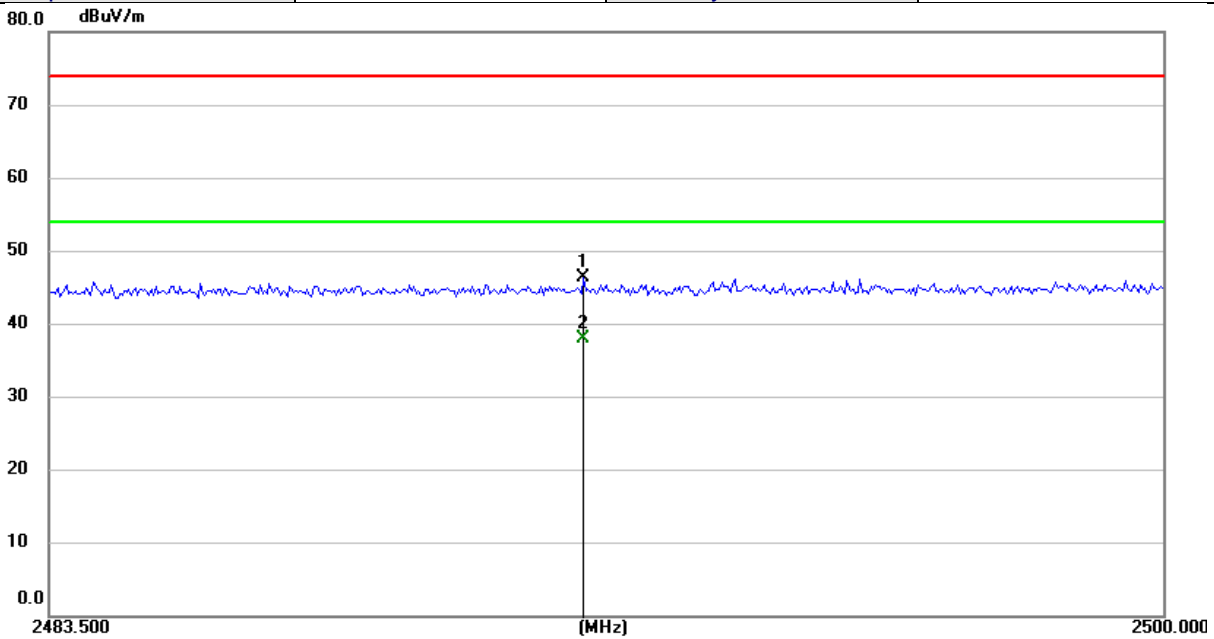



■ Spurious Emission below 1GHz (30MHz to 1GHz)  
All modes have been tested, and the worst result recorded was report as below:

Model No.:	Y113S
Phase:	Vertical
Test Power :	DC 3.7V
Standard:	FCC Part15C Radiation(QP)
Operating Mode :	TX 2402

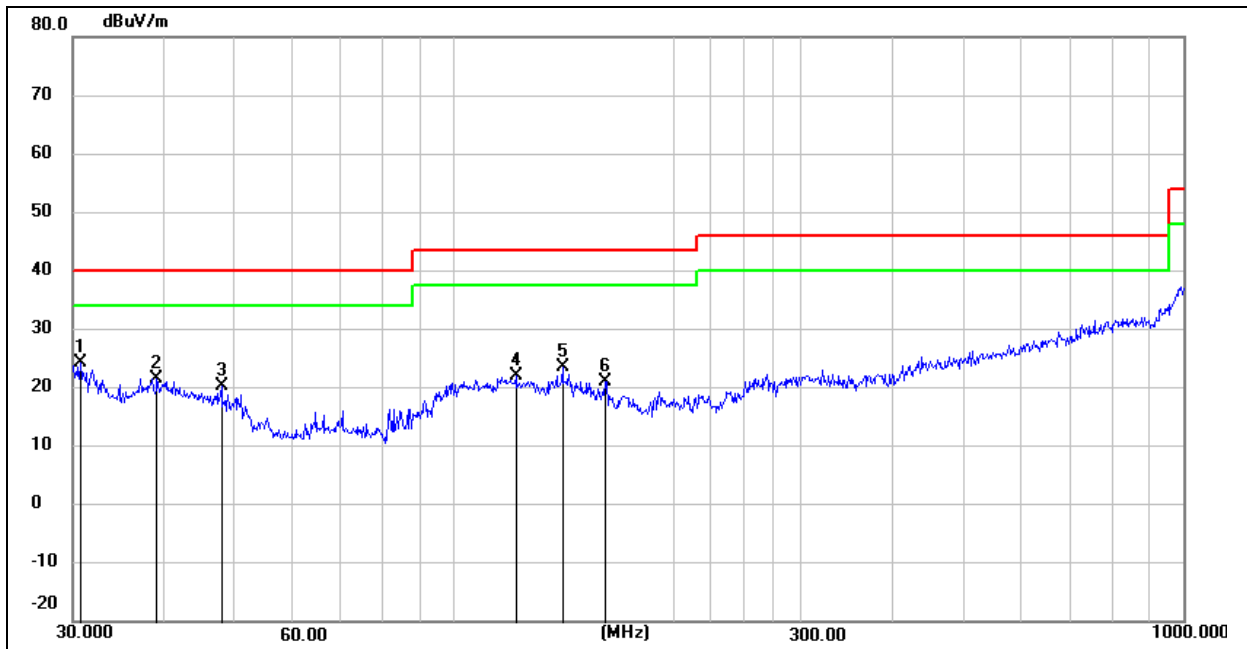

No.	Frequency (MHz)	Reading Level (dBuV)	Correct Factor (dB/m)	Emission Level (dBuV/m)	Limit (dBuV/m)	Margin (dB)	Remark			
1	30.745400	24.58	-0.43	24.15	40.00	-15.85	peak			
2	39.161300	26.51	-5.03	21.48	40.00	-18.52	peak			
3	47.993800	28.88	-8.69	20.19	40.00	-19.81	peak			
4	121.548500	25.26	-3.19	22.07	43.50	-21.43	peak			
5	140.835000	26.16	-2.64	23.52	43.50	-19.98	peak			
6	161.473900	25.63	-4.58	21.05	43.50	-22.45	peak			

Model No.:	Y113S
Phase:	Horizontal
Test Power :	DC 3.7V
Standard:	FCC Part15C Radiation(QP)
Operating Mode :	TX 2402

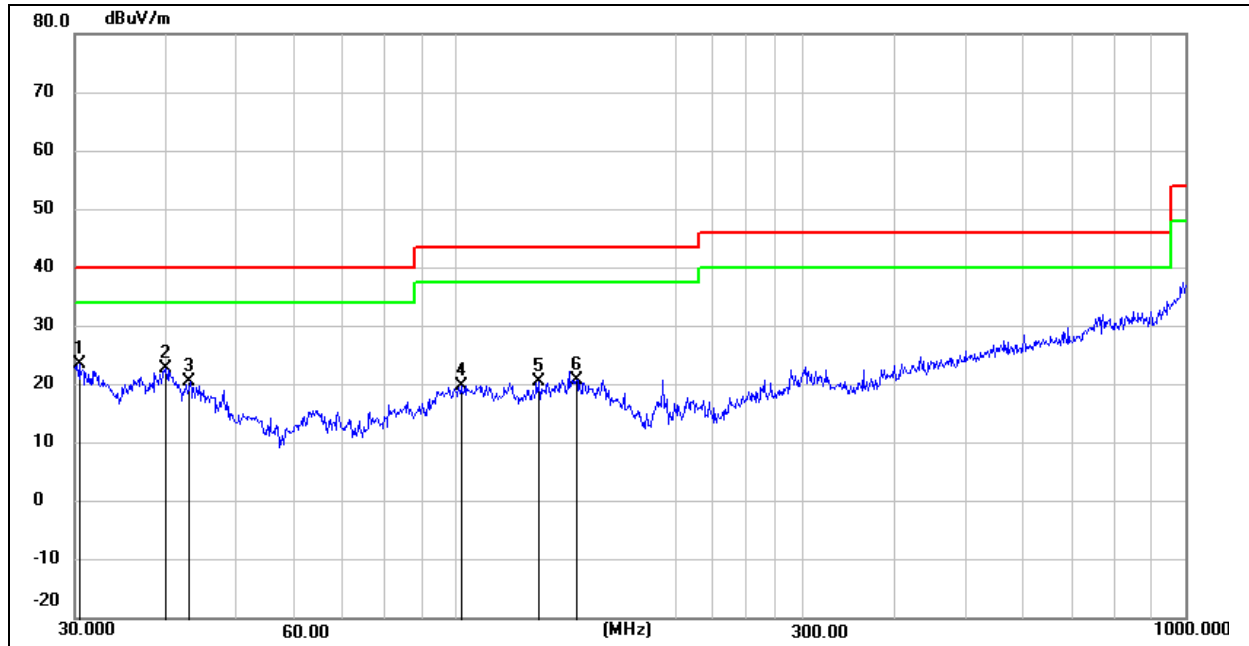

No.	Frequency (MHz)	Reading Level (dBuV)	Correct Factor (dB/m)	Emission Level (dBuV/m)	Limit (dBuV/m)	Margin (dB)	Remark			
1	30.423700	23.69	-0.08	23.61	40.00	-16.39	peak			
2	39.994100	27.80	-5.03	22.77	40.00	-17.23	peak			
3	43.201400	26.77	-6.27	20.50	40.00	-19.50	peak			
4	101.644300	24.55	-4.68	19.87	43.50	-23.63	peak			
5	129.922500	23.91	-3.27	20.64	43.50	-22.86	peak			
6	146.373400	23.93	-3.14	20.79	43.50	-22.71	peak			

Model No.:	Y113S
Phase:	Vertical
Test Power :	DC 3.7V
Standard:	FCC Part15C Radiation(QP)
Operating Mode :	TX 2440

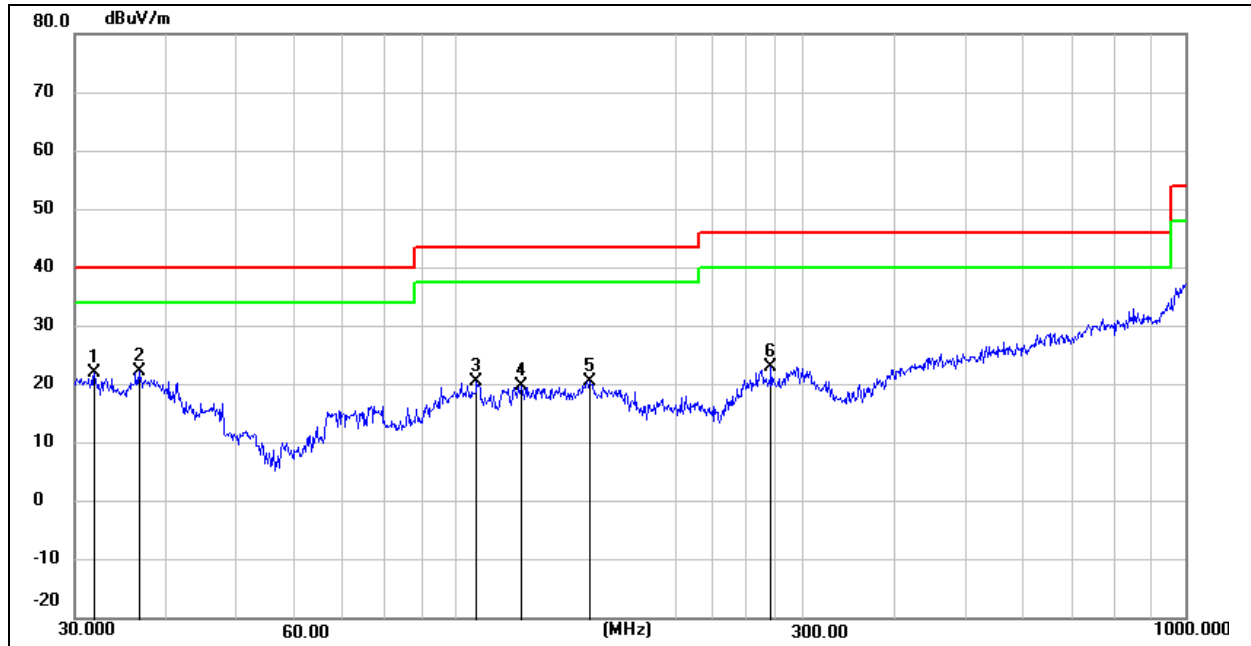

No.	Frequency (MHz)	Reading Level (dBuV)	Correct Factor (dB/m)	Emission Level (dBuV/m)	Limit (dBuV/m)	Margin (dB)	Remark			
1	31.954300	23.79	-1.75	22.04	40.00	-17.96	peak			
2	36.766100	27.24	-5.06	22.18	40.00	-17.82	peak			
3	106.758700	24.77	-4.37	20.40	43.50	-23.10	peak			
4	122.833700	23.00	-3.21	19.79	43.50	-23.71	peak			
5	152.663900	24.32	-3.74	20.58	43.50	-22.92	peak			
6	270.374700	25.83	-2.88	22.95	46.00	-23.05	peak			

Model No.:	Y113S
Phase:	Horizontal
Test Power :	DC 3.7V
Standard:	FCC Part15C Radiation(QP)
Operating Mode :	TX 2440

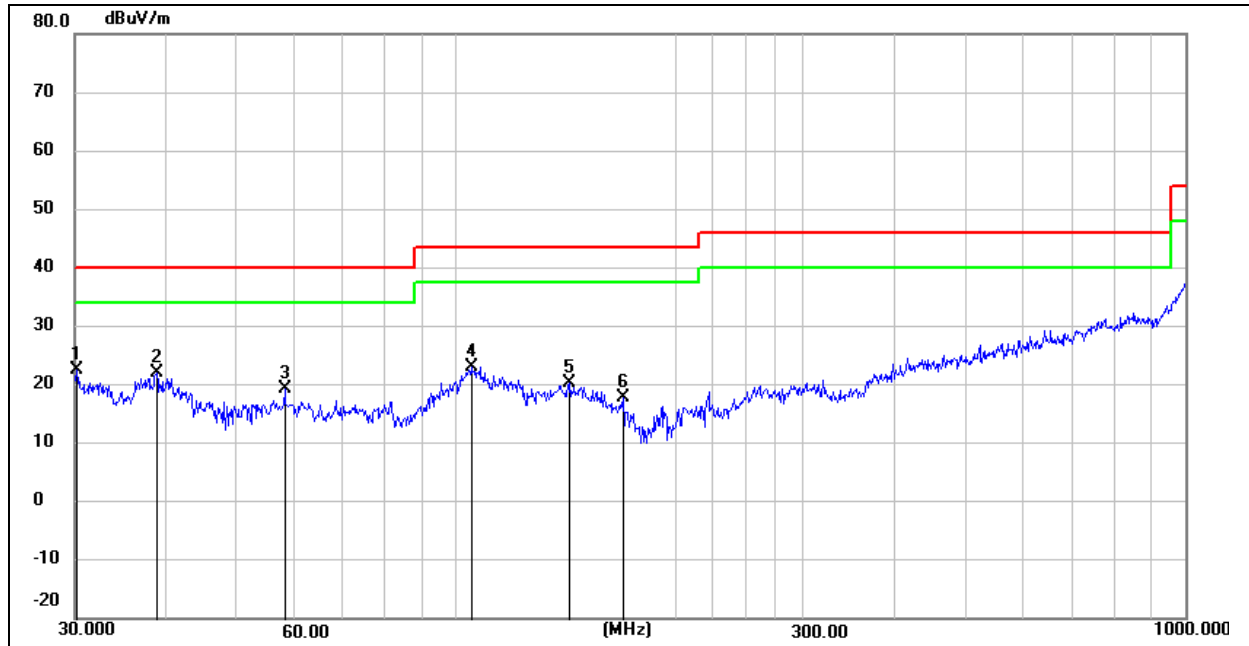

No.	Frequency (MHz)	Reading Level (dBuV)	Correct Factor (dB/m)	Emission Level (dBuV/m)	Limit (dBuV/m)	Margin (dB)	Remark			
1	30.210900	22.47	0.14	22.61	40.00	-17.39	peak			
2	38.887700	27.03	-5.04	21.99	40.00	-18.01	peak			
3	58.202800	33.26	-13.89	19.37	40.00	-20.63	peak			
4	104.903000	27.61	-4.48	23.13	43.50	-20.37	peak			
5	143.325800	23.21	-2.87	20.34	43.50	-23.16	peak			
6	169.598800	23.06	-5.23	17.83	43.50	-25.67	peak			

Model No.:	Y113S
Phase:	Vertical
Test Power :	DC 3.7V
Standard:	FCC Part15C Radiation(QP)
Operating Mode :	TX 2480

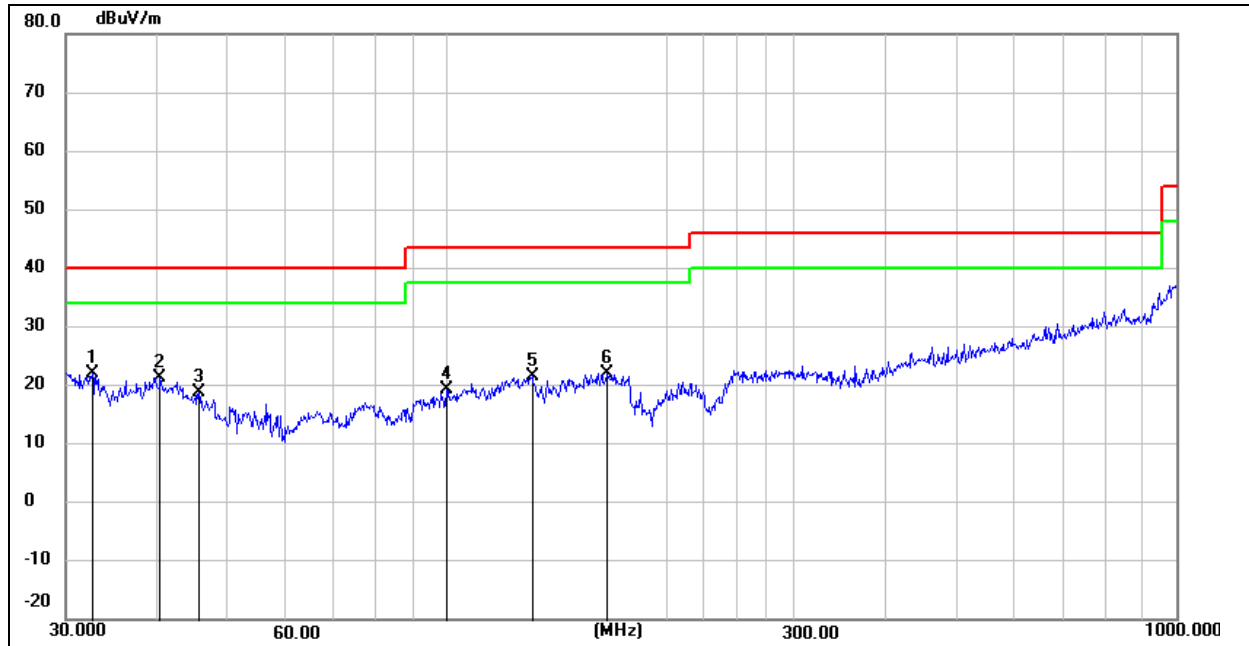

No.	Frequency (MHz)	Reading Level (dBuV)	Correct Factor (dB/m)	Emission Level (dBuV/m)	Limit (dBuV/m)	Margin (dB)	Remark			
1	32.634000	24.58	-2.49	22.09	40.00	-17.91	peak			
2	40.417000	26.50	-5.20	21.30	40.00	-18.70	peak			
3	45.694600	26.08	-7.37	18.71	40.00	-21.29	peak			
4	99.877700	24.05	-4.83	19.22	43.50	-24.28	peak			
5	130.836900	24.71	-3.22	21.49	43.50	-22.01	peak			
6	166.068000	26.94	-4.95	21.99	43.50	-21.51	peak			

Model No.:	Y113S
Phase:	Horizontal
Test Power :	DC 3.7V
Standard:	FCC Part15C Radiation(QP)
Operating Mode :	TX 2480

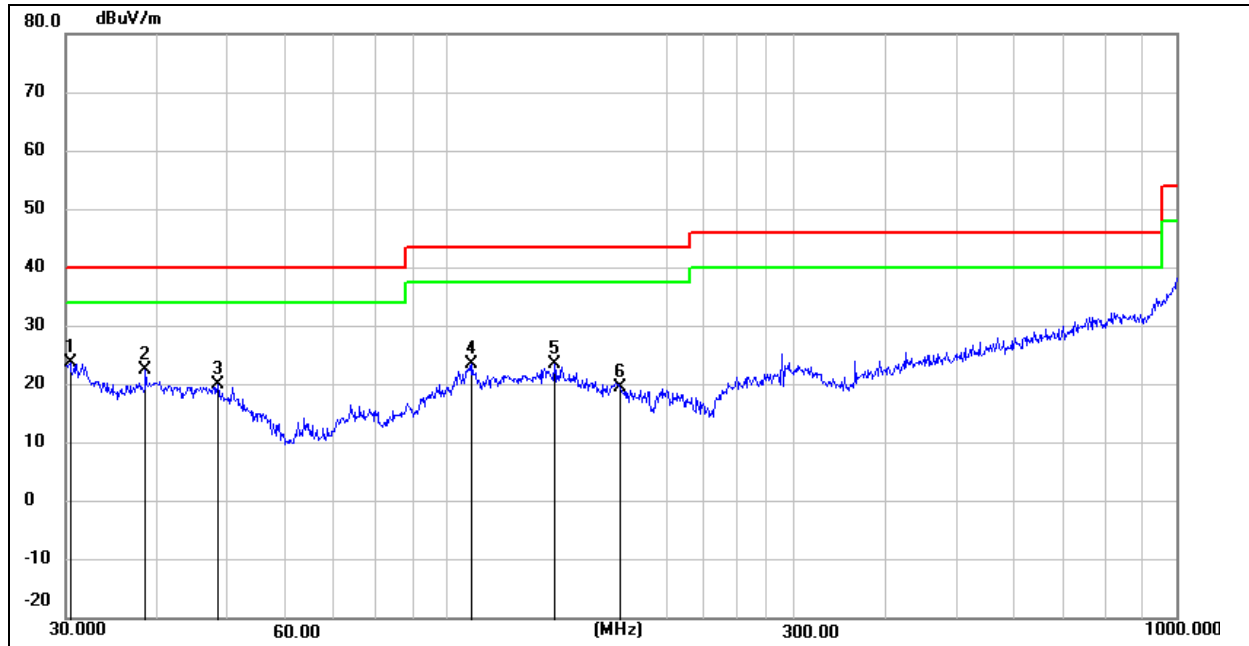

No.	Frequency (MHz)	Reading Level (dBuV)	Correct Factor (dB/m)	Emission Level (dBuV/m)	Limit (dBuV/m)	Margin (dB)	Remark			
1	30.423700	23.87	-0.08	23.79	40.00	-16.21	peak			
2	38.616000	27.54	-5.03	22.51	40.00	-17.49	peak			
3	48.501500	28.94	-8.97	19.97	40.00	-20.03	peak			
4	108.266400	27.87	-4.28	23.59	43.50	-19.91	peak			
5	140.342000	26.01	-2.60	23.41	43.50	-20.09	peak			
6	172.598700	25.24	-5.71	19.53	43.50	-23.97	peak			

## 7.6 CONDUCTED EMISSIONS TEST

### 7.6.1 Applicable Standard

According to FCC Part 15.207(a)

### 7.6.2 Conformance Limit

Frequency(MHz)	Conducted Emission Limit	
	Quasi-peak	Average
0.15-0.5	66-56	56-46
0.5-5.0	56	46
5.0-30.0	60	50

- Note: 1. The lower limit shall apply at the transition frequencies  
 2. The limit decreases in line with the logarithm of the frequency in the range of 0.15 to 0.50MHz.

Remark: Test results were obtained from the following equation:

$$\text{Measurement (dB}\mu\text{V)} = \text{LISN Factor (dB)} + \text{Cable Loss (dB)} + \text{Reading (dB}\mu\text{V)}$$

$$\text{Over (dB)} = \text{Measurement (dB}\mu\text{V)} - \text{Limit (dB}\mu\text{V)}$$

### 7.6.3 Test Configuration

Test according to clause 6.3 conducted emission test setup

### 7.6.4 Test Procedure

The EUT was placed on a table which is 0.8m above ground plane.  
 Maximum procedure was performed on the highest emissions to ensure EUT compliance.  
 Repeat above procedures until all frequency measured were complete.

### 7.6.5 Test Results

DC products are not applicable.

## 7.7 ANTENNA APPLICATION

### 7.7.1 Antenna Requirement

Standard	Requirement
FCC CRF Part 15.203	<p>An intentional radiator shall be designed to ensure that no antenna other than that furnished by the responsible party shall be used with the device. The use of a permanently attached antenna or of an antenna that uses a unique coupling to the intentional radiator shall be considered sufficient to comply with the provisions of this section. The manufacturer may design the unit so that a broken antenna can be replaced by the user, but the use of a standard antenna jack or electrical connector is prohibited. This requirement does not apply to carrier current devices or to devices operated under the provisions of §15.211, §15.213, §15.217, §15.219, or §15.221. Further, this requirement does not apply to intentional radiators that must be professionally installed, such as perimeter protection systems and some field disturbance sensors, or to other intentional radiators which, in accordance with §15.31(d), must be measured at the installation site. However, the installer shall be responsible for ensuring that the proper antenna is employed so that the limits in this part are not exceeded.</p>

For intentional device, according to FCC 47 CFR Section 15.203, an intentional radiator shall be designed to ensure that no antenna other than that furnished by the responsible party shall be used with the device. And according to FCC 47 CFR Section 15.247 (b), if transmitting antennas of directional gain greater than 6dBi are used, the power shall be reduced by the amount in dB that the directional gain of the antenna exceeds 6dBi.

### 7.7.2 Result

PASS.

The EUT has 1 antenna: a Chip Antenna for BT V5.3 with classic model, the gain is 2.7 dBi;

- Note:
- Antenna use a permanently attached antenna which is not replaceable.
  - Not using a standard antenna jack or electrical connector for antenna replacement
  - The antenna has to be professionally installed (please provide method of installation)

which in accordance to section 15.203, please refer to the internal photos.

----- END OF REPORT -----



## 声明 Statement

1. 本报告无授权批准人签字无效;  
This report will be void without authorized signature for testing report.
2. 未经许可本报告不得部分复制;  
This report shall not be copied partly without authorization.
3. 本报告的检测结果仅对送测样品有效, 委托方对样品的代表性和资料的真实性负责;  
The test results or observations are applicable only to tested sample. Client shall be responsible for representativeness of the sample and authenticity of the material.
4. 本检测报告中检测项目标注有特殊符号则该项目不在资质认定范围内, 仅作为客户委托、科研、教学或内部质量控制等目的使用;  
The observations or tests with special mark fall outside the scope of accreditation, and are only used for purpose of commission, research, training, internal quality control etc.
5. 本检测报告以实测值进行符合性判定, 未考虑不确定度所带来的风险, 本实验室不承担相关责任, 特别约定、标准或规范中有明确规定的除外;  
The test results or observations are provided in accordance with measured value, without taking risks caused by uncertainty into account. Without explicit stipulation in special agreements, standards or regulations, SLG-CPC shall not assume any responsibility.
6. 对本检测报告若有异议, 请于收到报告之日起 20 日内提出;  
Objections shall be raised within 20 days from the date receiving the report.