

Test Report

Product	Transportable Base Station System		
Name and address of the applicant	EXFO Finland Elektroniikkatie 2 FI-90590 Oulo, Finland		
Name and address of the manufacturer	EXFO Finland Elektroniikkatie 2 FI-90590 Oulo, Finland		
Model	FXm-C, FXm-XG, FXm-B100Lite 850/1900		
Rating	See clause 1.1		
Trademark	EXFO		
Serial number	See clause 1.1		
Additional information	GSM, WCDMA, LTE		
Tested according to	FCC Part 15, subpart B Other Class B Digital Device Industry Canada ICES-003, Issue 7 Information Technology Equipment (ITE)		
Order number	450342		
Tested in period	2022-01- to 2022-02-09		
Issue date	2022-09-15		
Name and address of the testing laboratory	 Instituttveien 6 Kjeller, Norway www.nemko.com	CAB Number: FCC: NO0001 ISED: NO0470	 
An accredited technical test executed under the Norwegian accreditation scheme			
 Prepared by [Frode Sveinsen]		 Approved by [G.Suhanthakumar]	
<p>This report shall not be reproduced except in full without the written approval of Nemko. Opinions and interpretations expressed within this report are not part of the current accreditation. This report was originally distributed electronically with digital signatures. For more information contact Nemko.</p>			

Revision history

Revision	Date	Comment	Sign
00	2022-03-22	First edition	FS
01	2022-08-10	Added FCC ID for EXFO Finland	FS
02	2022-09-15	Created separate report for B100 LITE and updated FCC ID	FS



THIS TEST REPORT APPLIES ONLY TO THE ITEM(S) AND CONFIGURATIONS TESTED.

Deviations from, additions to, or exclusions from the test specifications are described in "Summary of Test Data".

Nemko Group authorizes the above named entity to reproduce this report provided it is reproduced in its entirety and for use by the entity's employees only. Any reproduction of parts of this report requires approval in writing from Nemko Group.

Any use that a third party makes of this report, or any reliance on or decisions to be made based on it, are the responsibility of such third parties. Nemko Group accepts no responsibility for damages suffered by any third party caused by decisions made or actions based on this report.

CONTENTS

1	INFORMATION	4
1.1	Tested Item	4
1.2	Test Environment	5
1.3	Test Engineers	5
1.4	Test Equipment	5
1.5	Test Configurations	5
1.6	Other Comments	5
2	TEST REPORT SUMMARY	6
2.1	General	6
2.2	Test Summary	6
3	TEST RESULTS.....	7
3.1	Power Line Conducted Emissions	7
3.2	Spurious Emissions (Radiated), Class A.....	9
4	MODIFICATIONS TO PSU CABLES	11
5	MEASUREMENT UNCERTAINTY	12
6	TEST SETUPS	13
6.1	Radiated Emissions Test.....	13
6.2	Power Line Conducted Emissions Test.....	13
7	TEST EQUIPMENT USED	14

1 INFORMATION

1.1 Tested Item

Name	EXFO
Model Number	FXm-C FXm-XG FXm-B100Lite 850/1900
FCC ID	2A7IGEXCBTS100LITE
Power Supplies	TDK-Lambda Model: DTM300PW240D1 (Input 100-240V~3.3-1.4A, 50-60Hz, Output: 24.0V=12.5A, Max 300W) TDK-Lambda Model: DTM300PW280D1 (Input 100-240V~3.3-1.4A, 50-60Hz, Output: 28.0V=10.71A, Max 300W)

Model	FXm-C	FXm-XG	FXm-B100Lite 850/1900
Description	Controller	Main Unit	Amplifier Unit
Serial Number	1353058	1359742	5676-01-010
HW Version	3.0	4.1	2.0
SW Version	BSP 01.14.04-B328	/	/
Input Voltage	10-32 V _{DC}	N/A	20-32 V _{DC}
Antenna Conn.	N/A	N/A	N-Female
RF-Coupler	N/A	N/A	N/A
Power Supply	TDK-Lambda DTM300PW280D1	Powered from FXm-C	TDK-Lambda DTM300PW240D1

Characteristics	Description	
Radio System Type*	GSM, WCDMA, LTE	
Channel Spacing	GSM, WCDMA	0.2 MHz
	LTE	0.1 MHz
Channel Bandwidths	GSM	0.2 MHz
	WCDMA, LTE	5 MHz
Type of Modulation	GSM	8-PSK
	WCDMA	QPSK
	LTE	QPSK

1.2 Test Environment

Temperature:	20 – 23 °C
Relative humidity:	30 – 50 %
Normal test voltage:	120V 60Hz AC

The values are the limit registered during the test period.

All tests were performed with the listed power supplies powered from a regulated AC Power Source.

1.3 Test Engineers

Frode Sveinsen / Daniel Weber

1.4 Test Equipment

See list of test equipment in clause 6.

1.5 Test Configurations

Test Configuration	Tested with the EUT in standby mode.
--------------------	--------------------------------------

1.6 Other Comments

The system consists of Main Unit, Controller Unit and Amplifier Unit.

All three combinations have been tested with the listed power supplies.

For the Part 15B tests, the Power Supply cables were modified with ferrites, as shown in clause 4.

All tests were performed with the EUT in standby mode.

2 TEST REPORT SUMMARY

2.1 General

All measurements are traceable to national standards.

All tests were performed in accordance with ANSI C63.4-2014 where applicable. Radiated emissions are made in a 10m semi-anechoic chamber. A description of the test facility is on file with FCC and Industry Canada.

2.2 Test Summary

Name of test	FCC CFR 47, Paragraph #	ISED ICES-003, Issue 7, Paragraph #	Verdict
Power Line Conducted Emission	15.107(a)	3.2.1	Complies
Spurious Emissions (Radiated)	15.109	3.2.2	Complies

3 TEST RESULTS

3.1 Power Line Conducted Emissions

FCC Part 15.107 (a)

ISED ICES-003 Issue 7, Clause 3.2.1

Test Method: ANSI C63.4-2014 using 50 μ H/50 ohms LISN.

Test Results: **Complies**

Measurement Data: **See attached plots.**

The tests were performed to Class B limits.

All tests were performed with 120V 60Hz AC.

Highest measured value (L1 and N):

B100 Controller:

Frequency (MHz)	QuasiPeak (dB μ V)	Average (dB μ V)	Limit (dB μ V)	Margin (dB)	Meas. Time (ms)	Bandwidth (kHz)	Line	Filter
12.680	---	45.32	50.00	4.68	1000	9	L1	OFF
13.284	---	48.70	50.00	1.30	1000	9	L1	OFF
13.288	47.38	---	60.00	12.62	1000	9	L1	OFF
13.888	---	47.18	50.00	2.82	1000	9	L1	OFF
14.492	---	46.82	50.00	3.18	1000	9	N	OFF
14.492	47.88	---	60.00	12.12	1000	9	L1	OFF
16.908	---	47.58	50.00	2.42	1000	9	N	OFF
16.908	49.29	---	60.00	10.71	1000	9	L1	OFF
17.512	---	49.73	50.00	0.27	1000	9	N	OFF
17.512	50.83	---	60.00	9.17	1000	9	L1	OFF
18.112	---	47.95	50.00	2.05	1000	9	L1	OFF
18.116	49.66	---	60.00	10.34	1000	9	L1	OFF
18.720	---	44.27	50.00	5.73	1000	9	L1	OFF
21.132	---	46.75	50.00	3.25	1000	9	L1	OFF
21.740	---	42.97	50.00	7.03	1000	9	L1	OFF

B100 Lite:

Frequency (MHz)	QuasiPeak (dB μ V)	Average (dB μ V)	Limit (dB μ V)	Margin (dB)	Meas. Time (ms)	Bandwidth (kHz)	Line	Filter
---	---	---	---	---	---	---		

Full Spectrum

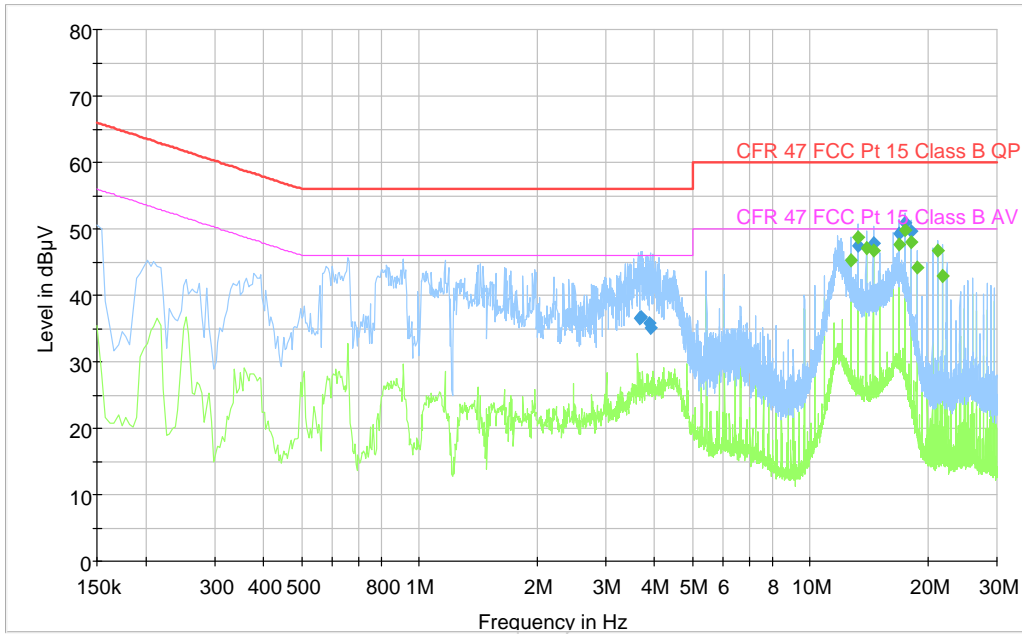

B100 Controller, 120V 60Hz

Full Spectrum

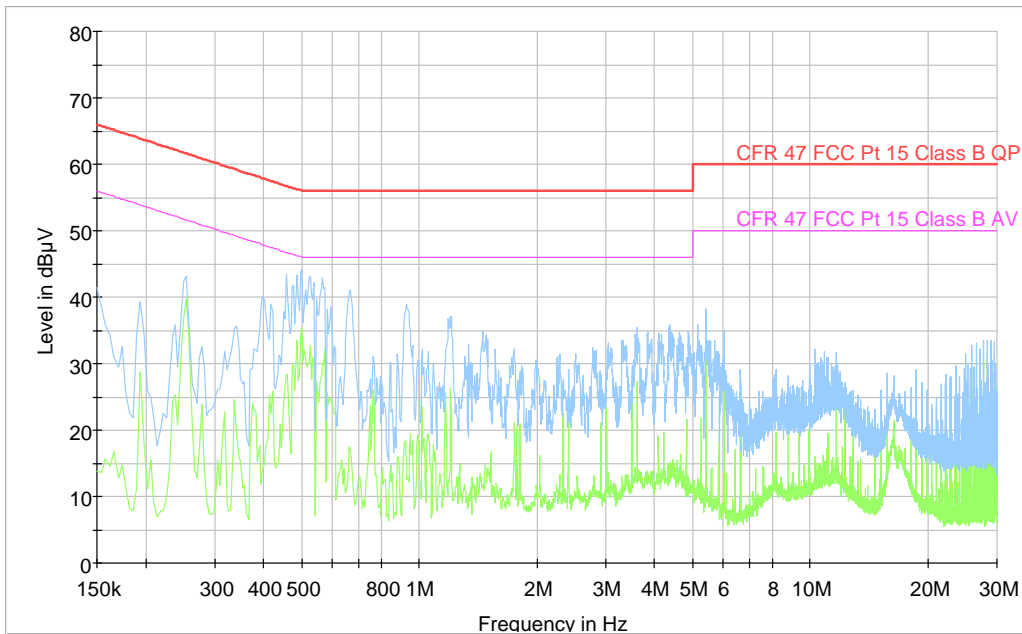

B100 Lite, 120V 60Hz

Blue is Peak Det
 Green is Average Det

3.2 Spurious Emissions (Radiated), Class A

FCC Part 15.109

ISED ICES-003 Issue 7, Clause 3.2.2

Test method: ANSI C63.4-2014, Class A @10m

Test Results:

Radiated Emissions 30 - 1000 MHz

Detector: Peak (found frequencies were measured with Quasi-Peak Detector)

Measuring distance 10m

The EUT were rotated 360 degrees and the antenna height varied between 1 and 4 m.

B100 Lite					
Measured Frequency (MHz)	Measuring Distance (m)	Detector	Measured Emission (dBµV/m)	Limit (dBµV/m)	Margin (dB)
68.87	10	QP	37.7	39.1	1.3
75.88	10	QP	34.2	39.1	4.8
249.99	10	QP	39.8	46.4	6.6

Limits, Class A

FCC	Part 15.109	
ISED	ICES-003 Issue 7, Clause 3.2.2	
	Radiated emission limit @10 meters	
Frequency (MHz)	FCC Part 15B QP (dBµV/m)	ISED ICES-003 QP (dBµV/m)
30 – 88	39.1	40.0
88 – 216	43.5	43.5
216 – 230	46.4	46.4
230 – 960	46.4	47.0
Above 960	49.5	49.5

¹ The limit above 1000 MHz is specified for Average Detector, when the measurement is performed with a Peak Detector a Duty-Cycle Correction Factor has to be calculated to find the corresponding Average Detector value.

Full Spectrum

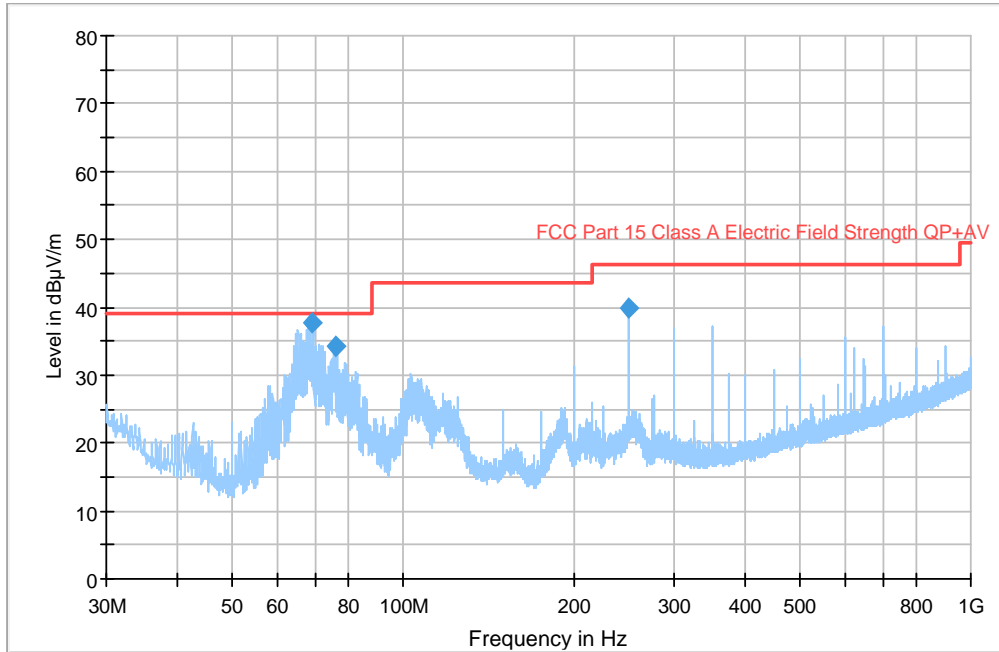



- Preview Result 1-PK+
- FCC Part 15 Class A Electric Field Strength QP+AV
- ◆ Final_Result QPK

Radiated Emissions 30 – 1000 MHz, B100 Lite

4 Modifications to PSU Cables

For Part 15B test ferrites had to be applied to the Power Supply cables as shown below.

<p>FXm-B100Lite 850/1900</p>	
	
<p>6 Ferrites type Würth 742 712 21 were added to the PSU cables, as shown on above photos</p>	

5 Measurement Uncertainty

Measurement Uncertainty Values		
Test Item		Uncertainty
Spurious Emissions, Radiated	< 1 GHz	±2.5 dB
	> 1 GHz	±2.2 dB
Power Line Conducted Emissions		+2.9 / -4.1 dB
Temperature Uncertainty		±1 °C

All uncertainty values are expanded standard uncertainty to give a confidence level of 95%, based on coverage factor k=2

6 Test Setups

6.1 Radiated Emissions Test

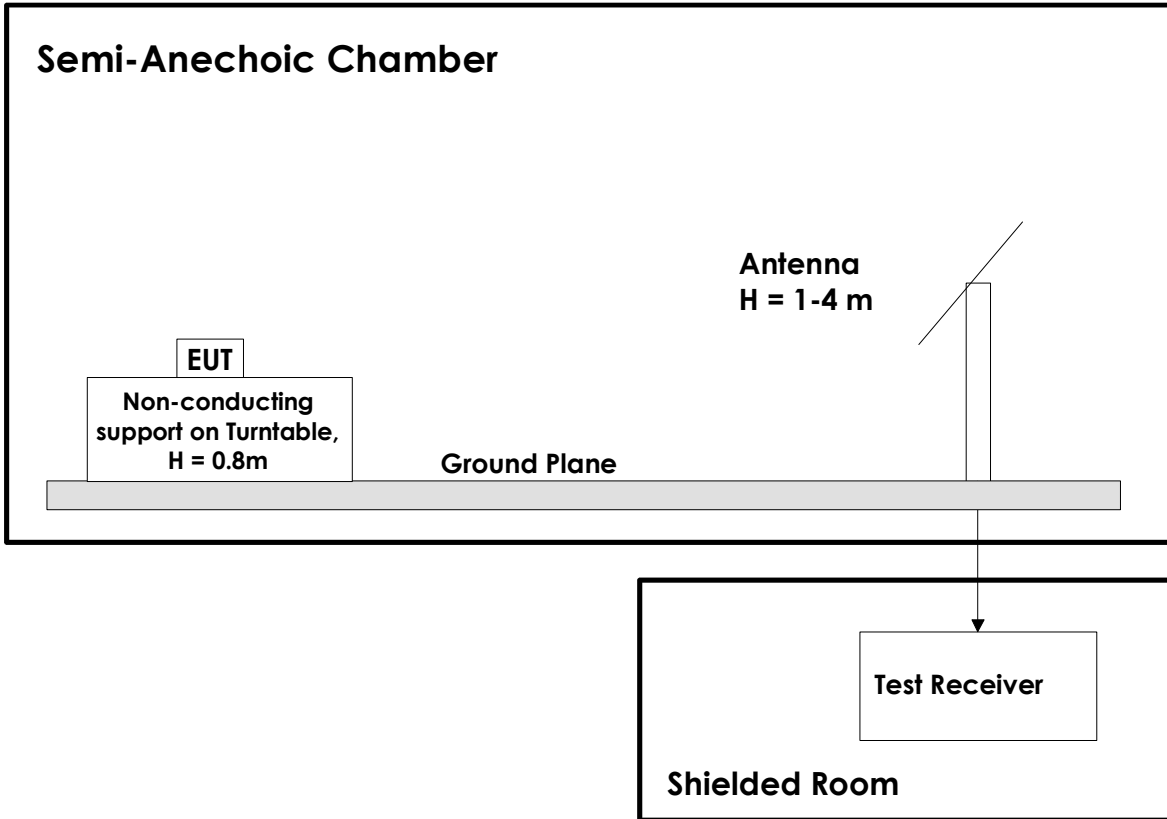

Test Set-Up 1

This test setup is used for all radiated emissions tests. For frequencies below 30 MHz the measuring distance is 10m, for all other frequencies it is 3m or 1m. Emissions above 1 GHz are measured with a Spectrum Analyzer and Horn Antenna. For measurements above 18 GHz the test receiver is moved inside the anechoic chamber and located next to the antenna to minimize the cable loss. All measurements at 1GHz and above were performed with turntable height 1.5m and with the ground plane covered by absorbers. A pre-amplifier is used for all measurements above 30 MHz.

6.2 Power Line Conducted Emissions Test

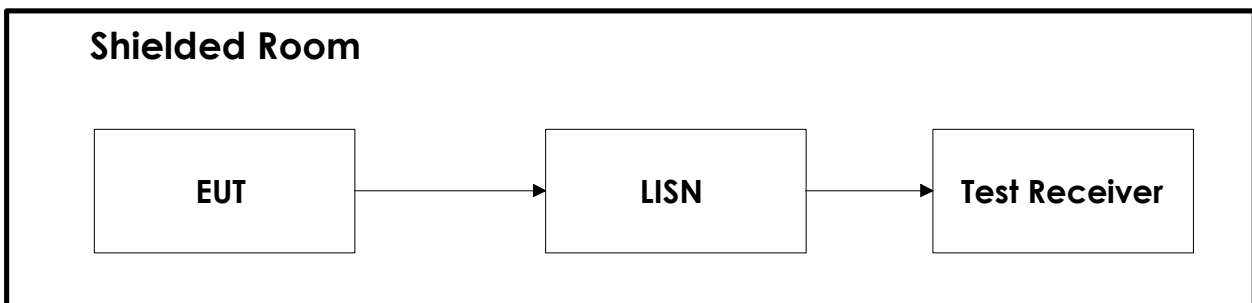

Test Set-Up 2

7 Test Equipment Used

To facilitate inclusion on each page of the test equipment used for related tests, each item of test equipment and ancillaries are identified (numbered) by the Testhouse.

No.	Model number	Description	Manufacturer	Ref. no.	Cal. date	Cal. Due
1	ESU40	Measuring Receiver	Rohde & Schwarz	LR 1639	2022-01	2023-01
2	L01G18G1	Low Pass Filter (1 GHz)	Microwave Circuits	LR 1768	2021-08	2022-08
3	JB3	BiLog Antenna	Sunol	N-4525	2020-03	2023-03
4	310	Preamplifier	Sonoma Inst.	LR 1686	2021-08	2022-08
5	6812B	AC Power Source	Agilent	LR 1515	2020-04	2022-04
6	ESCI3	Measuring Receiver	Rohde & Schwarz	N-4259	2021.10	2023-10
7	ENV216	Two Line V-Network	Rohde & Schwarz	LR 1665	2021-12	2023-12

COU = Calibrate on Use

The software listed below has been used for one or more tests.

No.	Manufacturer	Name	Version	Comment
1	Rohde & Schwarz	EMC32	10.50.40	EMC test software
3	Nemko AS	RSPlot	1.0.8.0	Screenshots from R&S Spectrum Analyzers