

# Antenna Specification

Manufacturer: Wuxi Weida Intelligent Electronics Co.,Ltd.  
Address: 3/F, Building A, Sensor High-end Manufacturing Base 789  
South Lake Avenue, Wuxi, Jiangsu Province, China

## Specifications

### Summary

ITEM	SPEC.	
Model Name	ISM 2.4 GHz	
Center Frequency	2400 MHz 2450 MHz 2500 MHz	1.92 dBi 1.58 dBi 0.49 dBi
MAX. GAIN	1.92 dBi	
Polarization	Horizontal	
Azimuth Beam Pattern	Omni-directional	
Impedance	50 Ω	
Antenna Length	8.4 mm	

### Antenna Photo & Length

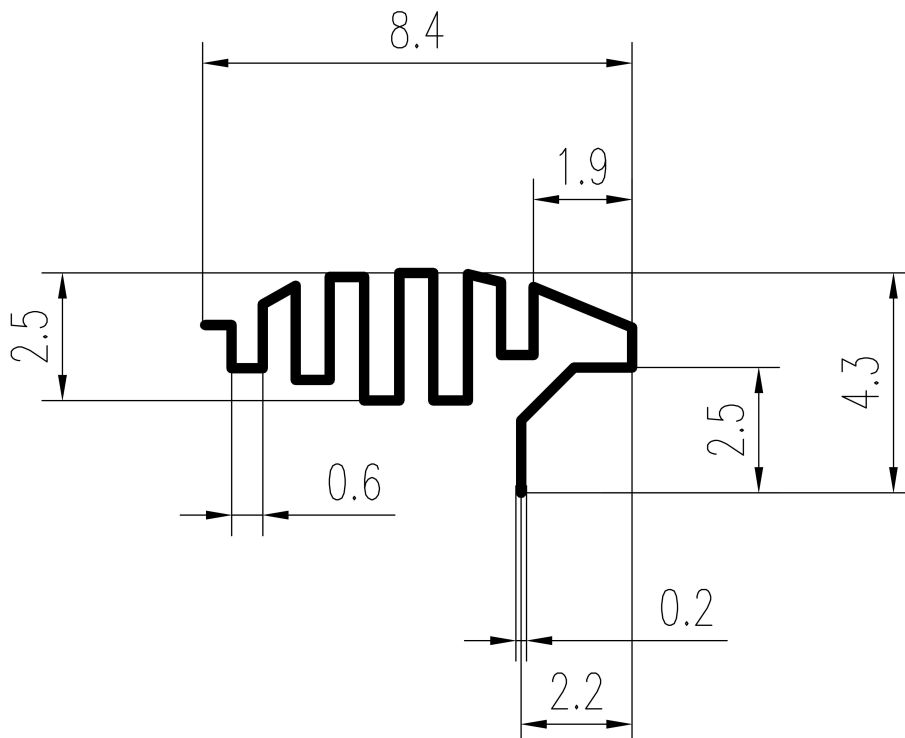

# 1. Main antenna : 2400 MHz

## 1.1 Horizontal

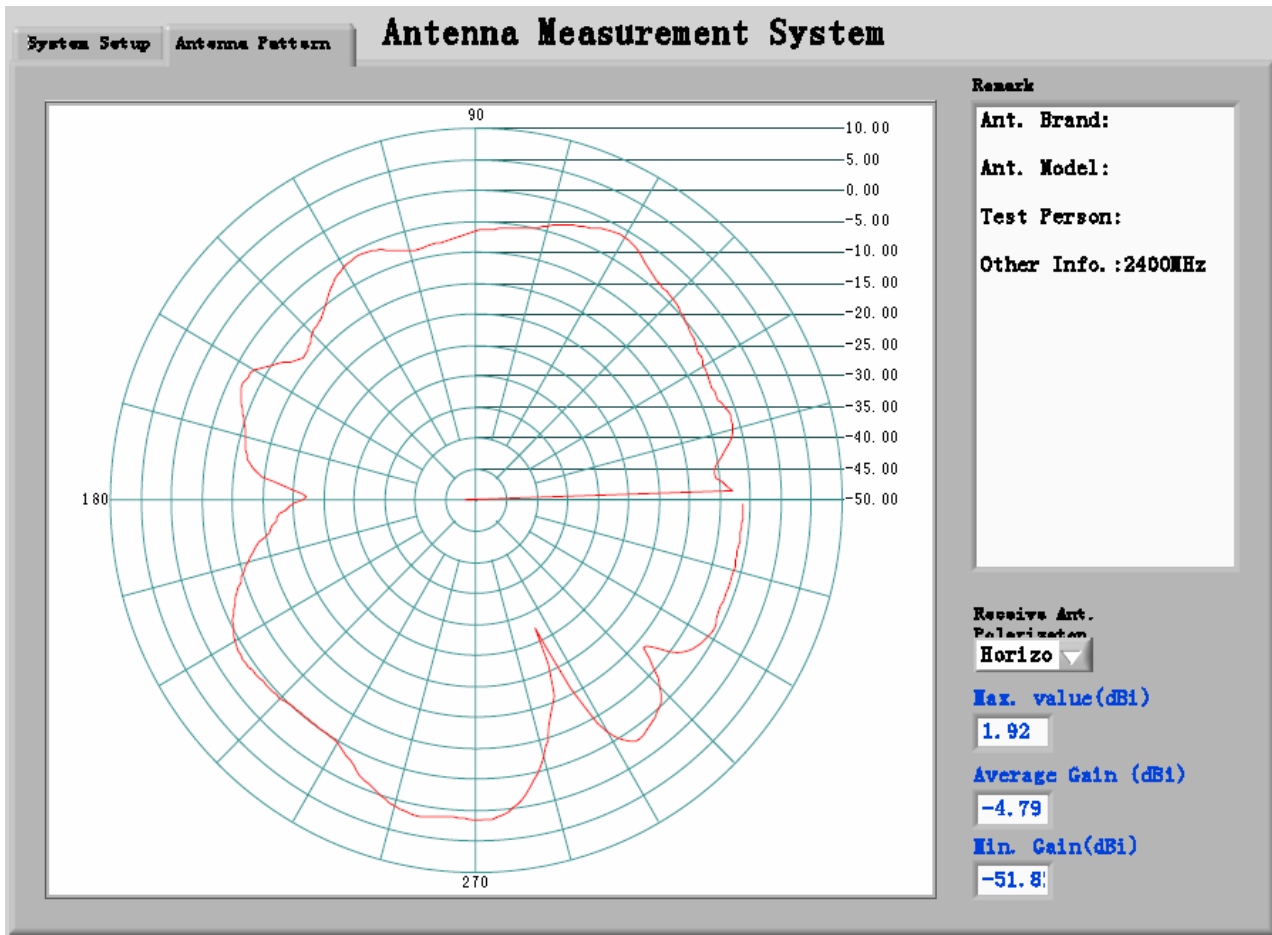

## 1.2 Vertical

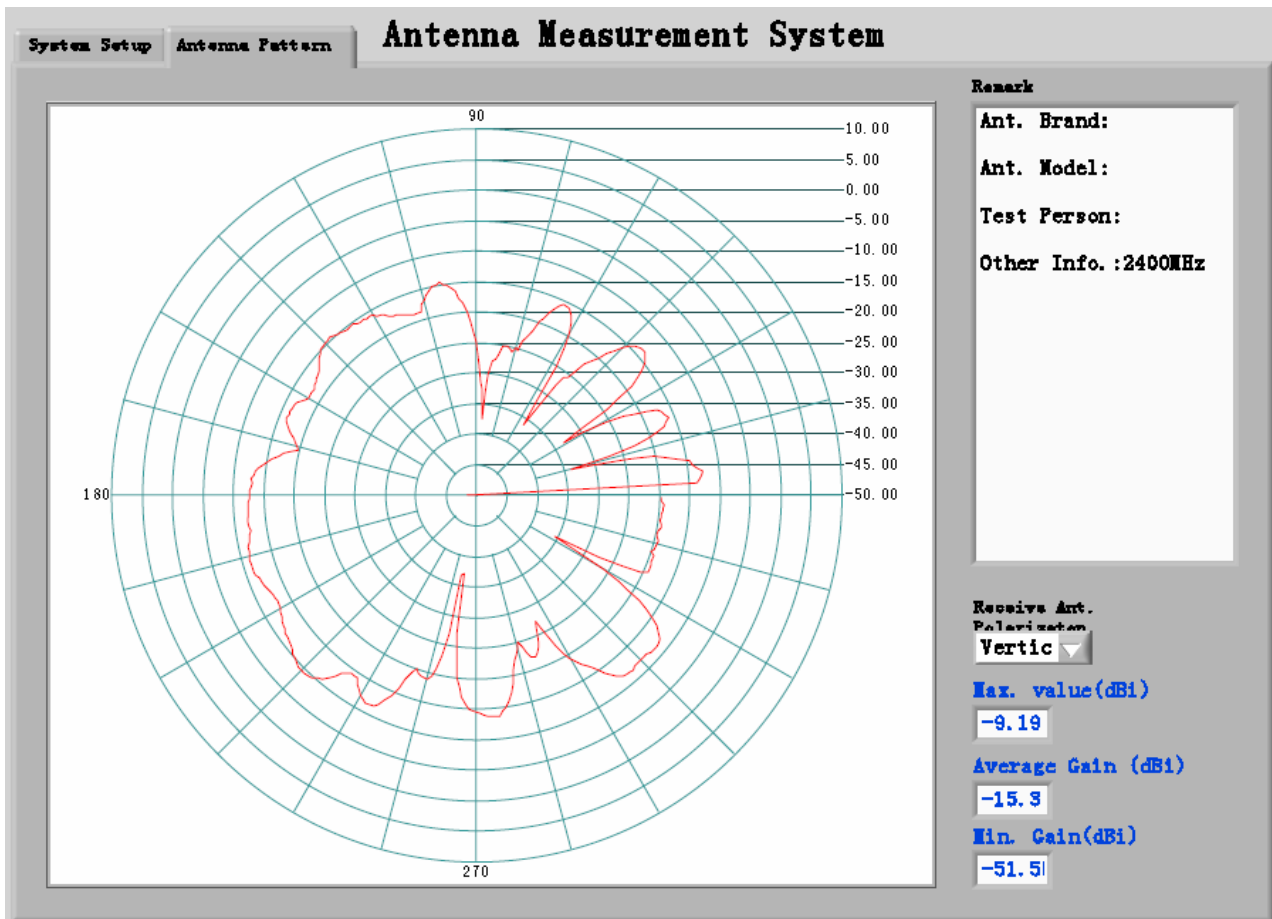

## 2. Main antenna : 2450 MHz

### 2.1 Horizontal

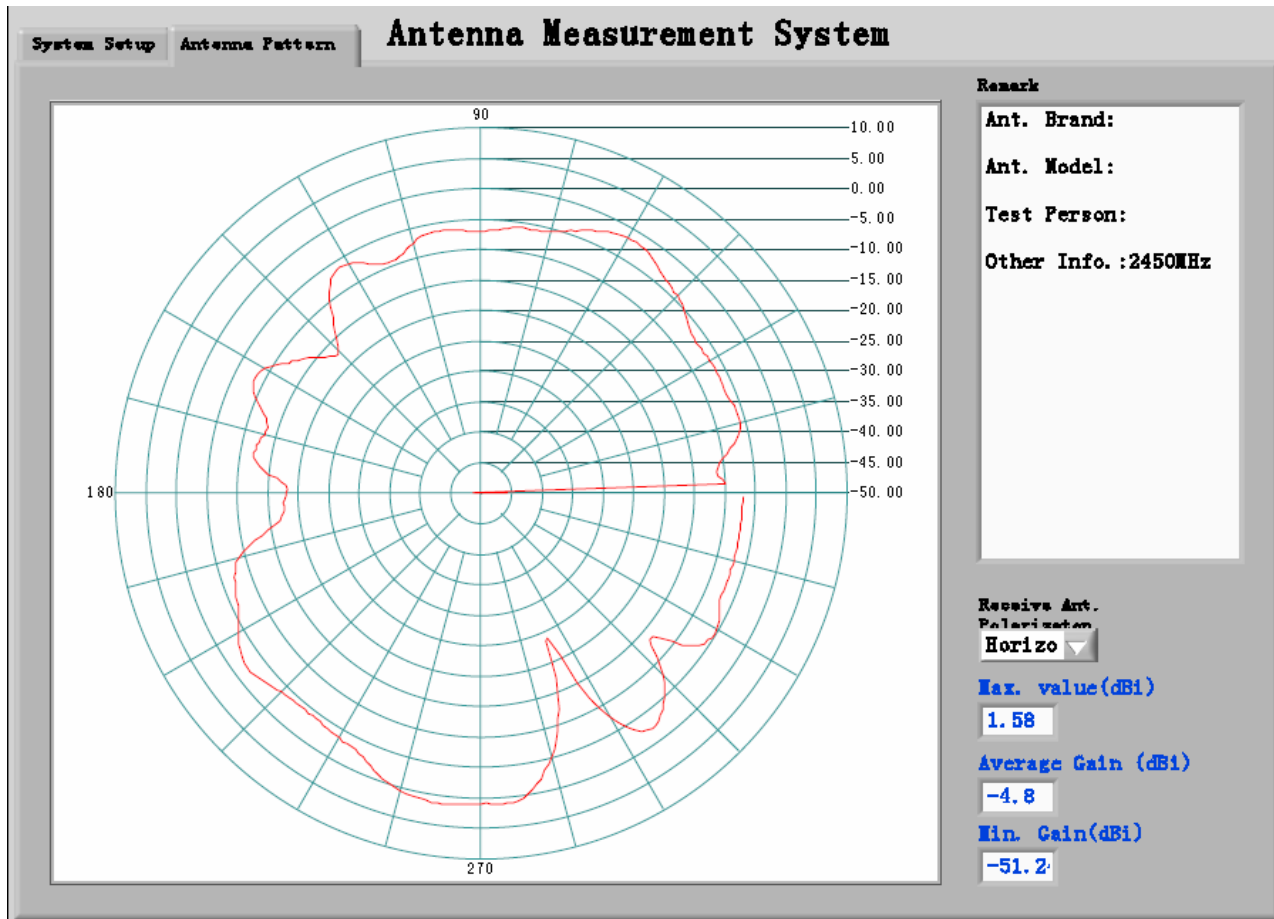

### 2.2 Vertical

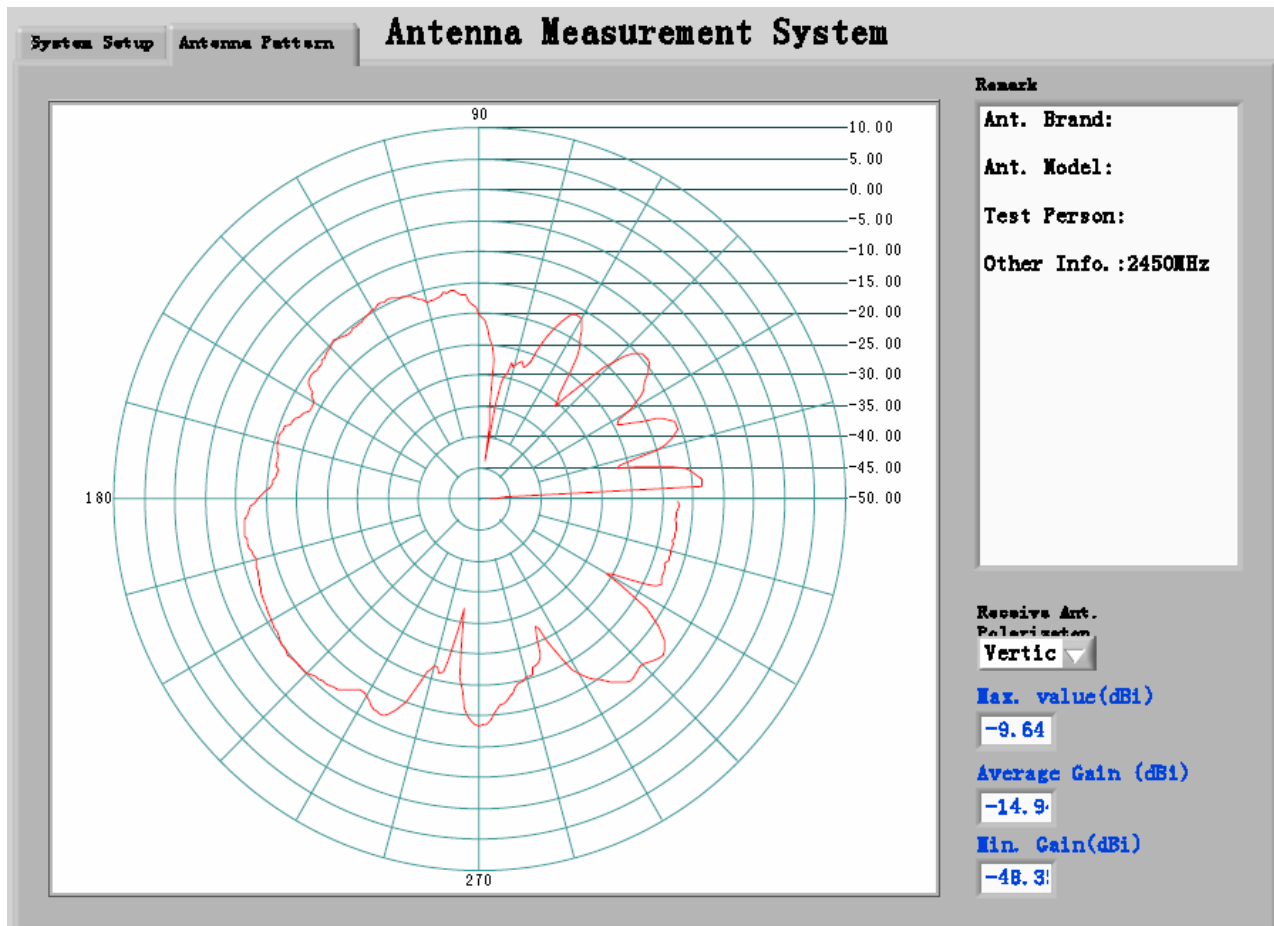

### 3. Main antenna : 2500 MHz

#### 3.1 Horizontal

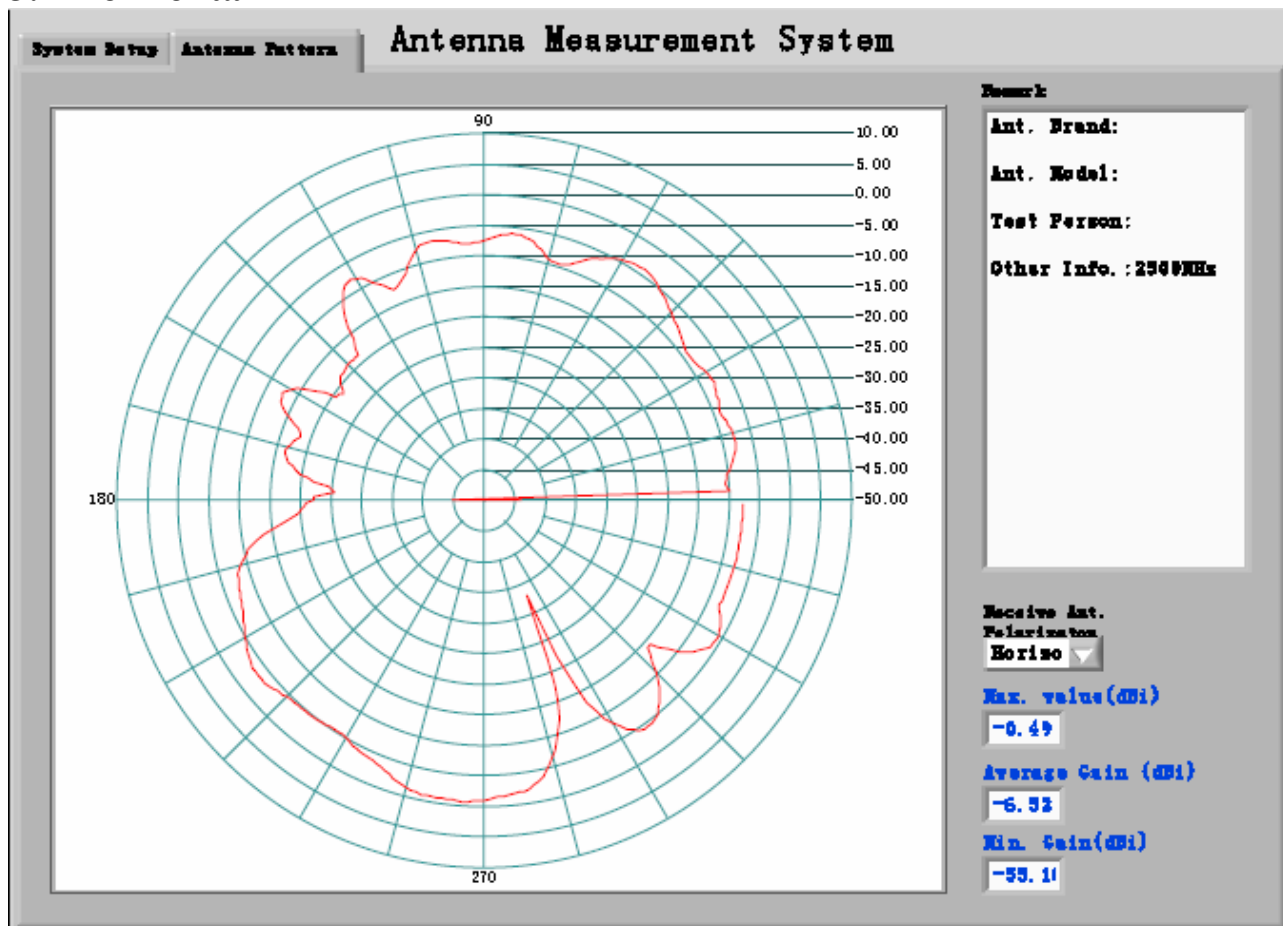

#### 3.2 Vertical

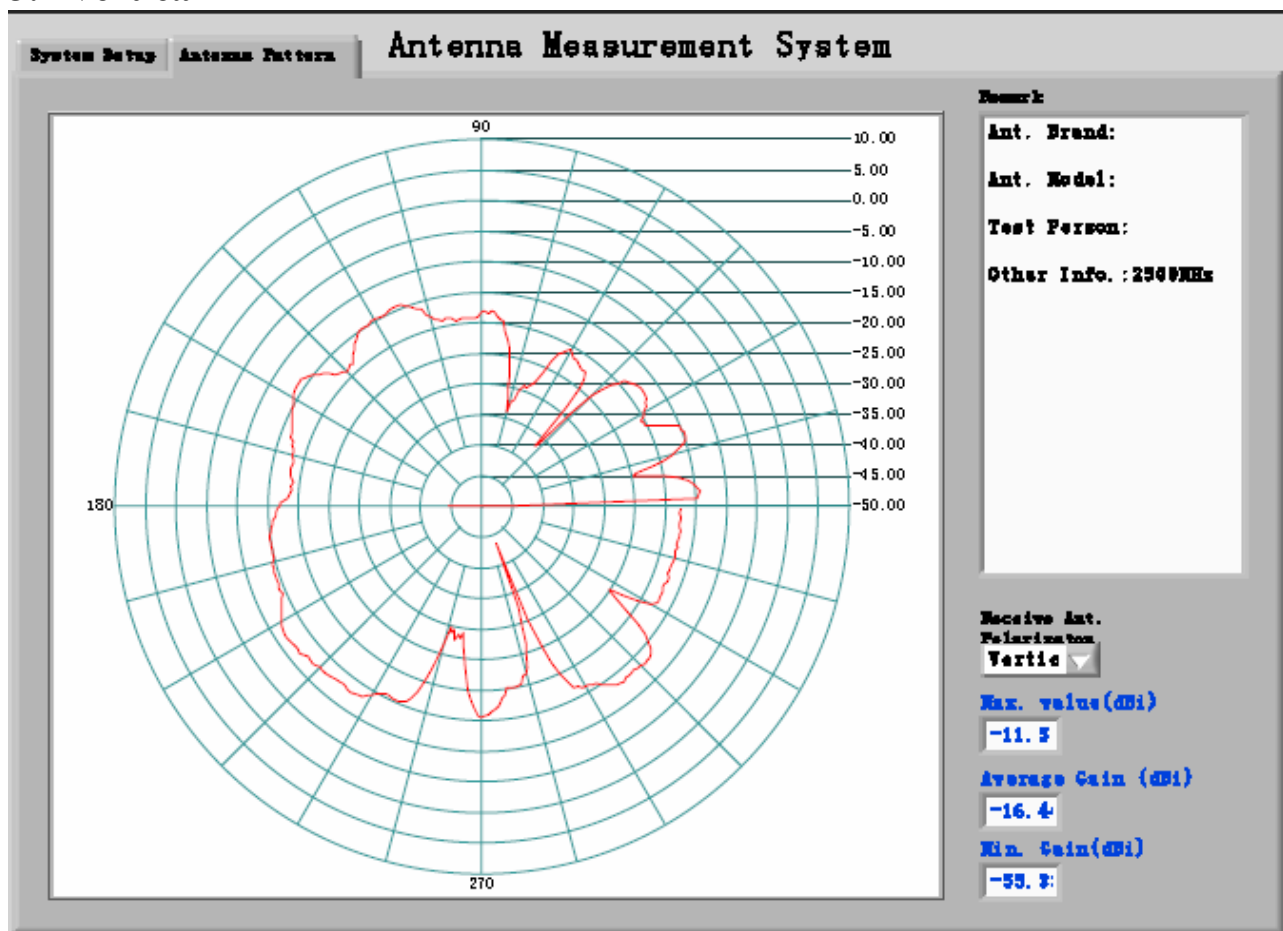

#### 4. Result

<b>Center Frequency</b>		<b>Maximum Ant Gain</b>
<b>2400 MHz</b>	<b>H</b>	<b>1.92 dBi</b>
	<b>V</b>	<b>-9.19 dBi</b>
<b>2450 MHz</b>	<b>H</b>	<b>1.58 dBi</b>
	<b>V</b>	<b>-9.64 dBi</b>
<b>2500 MHz</b>	<b>H</b>	<b>0.49 dBi</b>
	<b>V</b>	<b>-11.5 dBi</b>