



Shenzhen GUOREN Certification Technology Service Co., Ltd.

101#, Building K & Building T, The Second Industrial Zone, Jiazitang Community, Fenghuang Street, Guangming District, Shenzhen, China

FCC PART 15 SUBPART C TEST REPORT

FCC PART 15 SUBPART E 15.407

Report Reference No..... : GRCTR230802008-03

FCC ID..... : 2A7EH-S1PRO

Compiled by
(position+printed name+signature)..: Testing Engineer Jimmy Wang

Supervised by
(position+printed name+signature)..: Project Engineer Kelley Zhang

Approved by
(position+printed name+signature)..: Manager Sam Wang

Date of issue.....: Aug. 18, 2023

Testing Laboratory Name..... : Shenzhen GUOREN Certification Technology Service Co., Ltd.

Address..... : 101#, Building K & Building T, The Second Industrial Zone, Jiazitang Community, Fenghuang Street, Guangming District, Shenzhen, China

Applicant's name..... : Shenzhen Sanjiang Lechuang Technology Co., Ltd.

Address..... : Area 401B, 4th Floor, Building A7, No. 416, Xuegang North Road, Qinghu Community, Longhua Street, Longhua District, Shenzhen, Guangdong, China

Test specification..... :

Standard.....: **FCC Part 15 Subpart E 15.407**

Shenzhen GUOREN Certification Technology Service Co., Ltd. All rights reserved.

This publication may be reproduced in whole or in part for non-commercial purposes as long as the Shenzhen GUOREN Certification Technology Service Co., Ltd. is acknowledged as copyright owner and source of the material. Shenzhen GUOREN Certification Technology Service Co., Ltd. takes no responsibility for and will not assume liability for damages resulting from the reader's interpretation of the reproduced material due to its placement and context.

Test item description.....: 2 Channel Voice Controlled Smart Dash Cam

Trade Mark.....: VANTRUE

Manufacturer.....: Shenzhen Sanjiang Lechuang Technology Co., Ltd.

Model/Type reference.....: S1Pro

Listed Models: S2 PRO,S3,S3 PRO

Modulation: OFDM

Frequency.....: From 5180MHz-5240MHz, 5745MHz-5825MHz

Ratings.....: DC 12V

Result.....: **PASS**

TEST REPORT

Equipment under Test : 2 Channel Voice Controlled Smart Dash Cam

Model /Type : S1Pro

Listed Models : S2 PRO,S3,S3 PRO

Applicant : **Shenzhen Sanjiang Lechuang Technology Co., Ltd.**

Address : Area 401B, 4th Floor, Building A7, No. 416, Xuegang North Road, Qinghu Community, Longhua Street, Longhua District, Shenzhen, Guangdong, China

Manufacturer : **Shenzhen Sanjiang Lechuang Technology Co., Ltd.**

Address : Area 401B, 4th Floor, Building A7, No. 416, Xuegang North Road, Qinghu Community, Longhua Street, Longhua District, Shenzhen, Guangdong, China

Test Result:	PASS
---------------------	-------------

The test report merely corresponds to the test sample.
It is not permitted to copy extracts of these test result without the written permission of the test laboratory.

Contents

1 TEST STANDARDS	4
2 SUMMARY	5
2.1 General Remarks	5
2.2 Product Description	5
2.3 Short description of the Equipment under Test (EUT)	5
2.4 EUT operation mode	5
2.5 Block Diagram of Test Setup	6
2.6 Related Submittal(s) / Grant (s)	6
2.7 Modifications	6
3 TEST ENVIRONMENT	7
3.1 Address of the test laboratory	7
3.2 Test Facility	7
3.3 Environmental conditions	7
3.4 Test Description	8
3.5 Statement of the measurement uncertainty	8
3.6 Equipments Used during the Test	9
4 TEST CONDITIONS AND RESULTS	10
4.1 AC Power Conducted Emission	10
4.2 Radiated Emissions	11
4.3 Maximum Conducted Average Output Power	18
4.4 Power Spectral Density	20
4.5 Emission Bandwidth (26dB Bandwidth)	28
4.6 Minimum Emission Bandwidth (6dB Bandwidth)	32
4.7 Frequency Stability	36
5 TEST SETUP PHOTOS OF THE EUT	38
6 PHOTOS OF THE EUT	38

1 TEST STANDARDS

The tests were performed according to following standards:

[FCC Rules Part 15.407](#): UNLICENSED NATIONAL INFORMATION INFRASTRUCTURE DEVICES.

[ANSI C63.10-2013](#): American National Standard for Testing Unlicensed Wireless Devices

[KDB 789033 D02](#): GUIDELINES FOR COMPLIANCE TESTING OF UNLICENSED NATIONAL INFORMATION INFRASTRUCTURE (U-NII) DEVICES PART 15, SUBPART E

2 SUMMARY

2.1 General Remarks

Date of receipt of test sample	:	Aug. 07, 2023
Testing commenced on	:	Aug. 07, 2023
Testing concluded on	:	Aug. 18, 2023

2.2 Product Description

Product Name:	2 Channel Voice Controlled Smart Dash Cam			
Model/Type reference:	S1Pro			
Listed Models:	S2 PRO,S3,S3 PRO(The products are identical in interior structure, electrical circuits and components, just model names is different.)			
Power supply:	DC 12V			
Sample ID:	GRCTR230802008-1# (Engineer sample), GRCTR230802008-2# (Normal sample)			
Firmware Version:	VTS1Pro			
Hardware Version:	V1.1			
WIFI				
	20MHz system	40MHz system	80MHz system	160MHz system
Supported type:	802.11a 802.11n 802.11ac	802.11n 802.11ac	802.11ac	N/A
Operation frequency:	5180MHz-5240MHz 5745MHz-5825MHz	5190MHz-5230MHz 5755MHz-5795MHz	5210MHz 5775MHz	N/A
Modulation:	OFDM	OFDM	OFDM	N/A
Channel number:	9	4	2	N/A
Channel separation:	20MHz	40MHz	80MHz	N/A
Antenna type:	FPC antenna			
Antenna gain:	1.27 dBi for 5180MHz-5240MHz 1.21 dBi for 5745MHz-5825MHz			
Remark:*When the information provided by the customer was used to calculate test results, if the information provided by the customer is not accurate, shenzhen GUOREN Certification Technology Service Co., Ltd. does not assume any responsibility.				

2.3 Short description of the Equipment under Test (EUT)

This is a 2 Channel Voice Controlled Smart Dash Cam.

For more details, refer to the user's manual of the EUT.

2.4 EUT operation mode

The Applicant provides communication tools software(SecureCRT) to control the EUT for staying in continuous transmitting (Duty Cycle more than 98%) for testing meet KDB558074 test requirement.

Operation Frequency List WIFI on 5G Band:

Operating band	20MHz		40MHz		80MHz	
	Channel	Frequency (MHz)	Channel	Frequency (MHz)	Channel	Frequency (MHz)
U-NII 1 (5150MHz-5250MHz)	36	5180	38	5190	42	5210
	40	5200				
	44	5220	46	5230		
	48	5240				
U-NII 3 (5725MHz-5850MHz)	149	5745	151	5755	155	5775
	153	5765	159	5795		
	157	5785				
	161	5805				
	165	5825	--	--		

Note: The line display in grey is those Channels/Frequencies select to test in this report for each operation mode.

2.5 Block Diagram of Test Setup

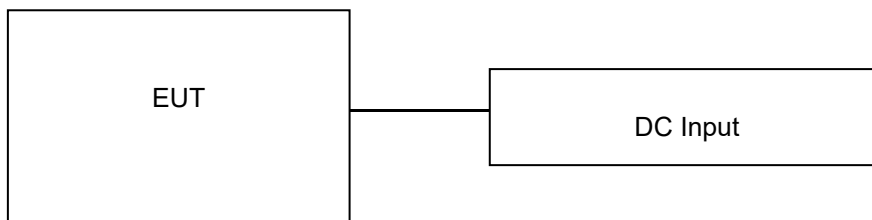

2.6 Related Submittal(s) / Grant (s)

This submittal(s) (test report) is intended to comply with Section 15.407 of the FCC Part 15, Subpart E Rules.

2.7 Modifications

No modifications were implemented to meet testing criteria.

3 TEST ENVIRONMENT

3.1 Address of the test laboratory

Shenzhen GUOREN Certification Technology Service Co., Ltd.

101#, Building K & Building T, The Second Industrial Zone, Jiazitang Community, Fenghuang Street, Guangming District, Shenzhen, China

3.2 Test Facility

The test facility is recognized, certified, or accredited by the following organizations:

FCC-Registration No.: 920798 Designation Number: CN1304

Shenzhen GUOREN Certification Technology Service Co., Ltd. has been listed on the US Federal Communications Commission list of test facilities recognized to perform electromagnetic emissions measurements.

A2LA-Lab Cert. No.: 6202.01

Shenzhen GUOREN Certification Technology Service Co., Ltd. has been listed by American Association for Laboratory Accreditation to perform electromagnetic emission measurement.

ISED#: 27264 CAB identifier: CN0115

Shenzhen GUOREN Certification Technology Service Co., Ltd. has been listed by Innovation, Science and Economic Development Canada to perform electromagnetic emission measurement.

CNAS-Lab Code: L15631

Shenzhen GUOREN Certification Technology Service Co., Ltd. has been assessed and proved to be in compliance with CNAS-CL01 Accreditation Criteria for Testing and Calibration Laboratories for the Competence of Testing and Calibration Laboratories.

The 3m-Semi anechoic test site fulfils CISPR 16-1-4 according to ANSI C63.10 and CISPR 16-1-4:2010.

3.3 Environmental conditions

During the measurement the environmental conditions were within the listed ranges:

Normal Temperature	15-35 °C
Relative Humidity	30-60 %
Air Pressure	950-1050mbar

3.4 Test Description

FCC Requirement		
FCC Part 15.207	AC Power Conducted Emission	N/A ^{Note4}
FCC Part 15.407(a)	Emission Bandwidth(26dBm Bandwidth)	N/A ^{Note1}
FCC Part 15.407(e)	Minimum Emission Bandwidth(6dBm Bandwidth)	PASS ^{Note2}
FCC Part 15.407(a)	Maximum Conducted Output Power	PASS
FCC Part 15.407(a)	Peak Power Spectral Density	PASS
FCC Part 15.407(g)	Frequency Stability	PASS
FCC Part 15.407(b)	Undesirable emission	PASS
FCC Part 15.407(b)/15.205/15.209	Radiated Emissions	PASS
FCC Part 15.407(h)	Dynamic Frequency Selection	N/A ^{Note 3}
FCC Part 15.203/15.247(b)	Antenna Requirement	PASS

Note 1: Apply to U-NII 1, U-NII 2A, and U-NII 2C band.

Note 2: Apply to U-NII 3 band only.

Note 3: This device not work in DFS band.

Note 4: N/A means “not applicable”.

Data Rate Used:

Preliminary tests were performed in different data rate to find the worst radiated emission. The data rate shown in the table below is the worst-case rate with respect to the specific test item. Investigation has been done on all the possible configurations for searching the worst cases. The following table is a list of the test modes shown in this test report.

Test Items	Mode	Data Rate
Maximum Conducted Output Power Power Spectral Density Emission Bandwidth(26dBm Bandwidth) Minimum Emission Bandwidth(6dBm Bandwidth) Undesirable emission Frequency Stability	11a/OFDM	6 Mbps
	11n(20MHz),11ac(20MHz)/OFDM	7.2 Mbps
	11n(40MHz),11ac(40MHz)/OFDM	15.0Mbps
	11ac(80MHz)/OFDM	65.0Mbps

3.5 Statement of the measurement uncertainty

The data and results referenced in this document are true and accurate. The reader is cautioned that there may be errors within the calibration limits of the equipment and facilities. The measurement uncertainty was calculated for all measurements listed in this test report acc. to TR-100028-01” Electromagnetic compatibility and Radio spectrum Matters (ERM);Uncertainties in the measurement of mobile radio equipment characteristics; Part 1” and TR-100028-02 “Electromagnetic compatibility and Radio spectrum Matters (ERM);Uncertainties in the measurement of mobile radio equipment characteristics; Part 2 “ and is documented in the Shenzhen GUOREN Certification Technology Service Co., Ltd.quality system acc. to DIN EN ISO/IEC 17025. Furthermore, component and process variability of devices similar to that tested may result in additional deviation. The manufacturer has the sole responsibility of continued compliance of the device.

Hereafter the best measurement capability for Shenzhen GUOREN Certification Technology Service Co., Ltd.:

Test	Range	Measurement Uncertainty	Notes
Radiated Emission	30~1000MHz	4.06 dB	(1)
Radiated Emission	1~18GHz	5.14 dB	(1)

Radiated Emission	18-40GHz	5.38 dB	(1)
Conducted Disturbance	0.15~30MHz	2.14 dB	(1)

(1) This uncertainty represents an expanded uncertainty expressed at approximately the 95% confidence level using a coverage factor of k=2.

3.6 Equipments Used during the Test

Test Equipment	Manufacturer	Model No.	Equipment No.	Calibration Date	Calibration Due Date
LISN	R&S	ENV216	GRCTEE009	2022/10/12	2023/10/11
LISN	R&S	ENV216	GRCTEE010	2022/10/12	2023/10/11
EMI Test Receiver	R&S	ESPI	GRCTEE017	2022/10/12	2023/10/11
EMI Test Receiver	R&S	ESCI	GRCTEE008	2022/10/12	2023/10/11
Spectrum Analyzer	Agilent	N9020A	GRCTEE002	2022/10/12	2023/10/11
Spectrum Analyzer	R&S	FSP	GRCTEE003	2022/10/12	2023/10/11
Vector Signal generator	Agilent	N5181A	GRCTEE007	2022/10/12	2023/10/11
Analog Signal Generator	R&S	SML03	GRCTEE006	2022/10/12	2023/10/11
Climate Chamber	QIYA	LCD-9530	GRCTES016	2022/10/12	2023/10/11
Ultra-Broadband Antenna	Schwarzbeck	VULB9163	GRCTEE018	2020/10/25	2023/10/24
Horn Antenna	Schwarzbeck	BBHA 9120D	GRCTEE019	2020/10/25	2023/10/24
Loop Antenna	Zhinan	ZN30900C	GRCTEE020	2020/10/25	2023/10/24
Horn Antenna	Beijing Hangwei Dayang	OBH100400	GRCTEE049	2021/1/18	2024/1/17
Amplifier	Schwarzbeck	BBV 9745	GRCTEE021	2022/10/12	2023/10/11
Amplifier	Taiwan chengyi	EMC051845B	GRCTEE022	2022/10/12	2023/10/11
Temperature/Humidity Meter	Huaguan	HG-308	GRCTES037	2022/10/12	2023/10/11
Directional coupler	NARDA	4226-10	GRCTEE004	2022/10/12	2023/10/11
High-Pass Filter	XingBo	XBLBQ-GTA18	GRCTEE053	2022/10/12	2023/10/11
High-Pass Filter	XingBo	XBLBQ-GTA27	GRCTEE054	2022/10/12	2023/10/11
Automated filter bank	Tonscend	JS0806-F	GRCTEE055	2022/10/12	2023/10/11
Power Sensor	Agilent	U2021XA	GRCTEE070	2022/10/12	2023/10/11
EMI Test Software	ROHDE & SCHWARZ	ESK1-V1.71	GRCTEE060	N/A	N/A
EMI Test Software	Fera	EZ-EMC	GRCTEE061	N/A	N/A

4 TEST CONDITIONS AND RESULTS

4.1 AC Power Conducted Emission

TEST CONFIGURATION

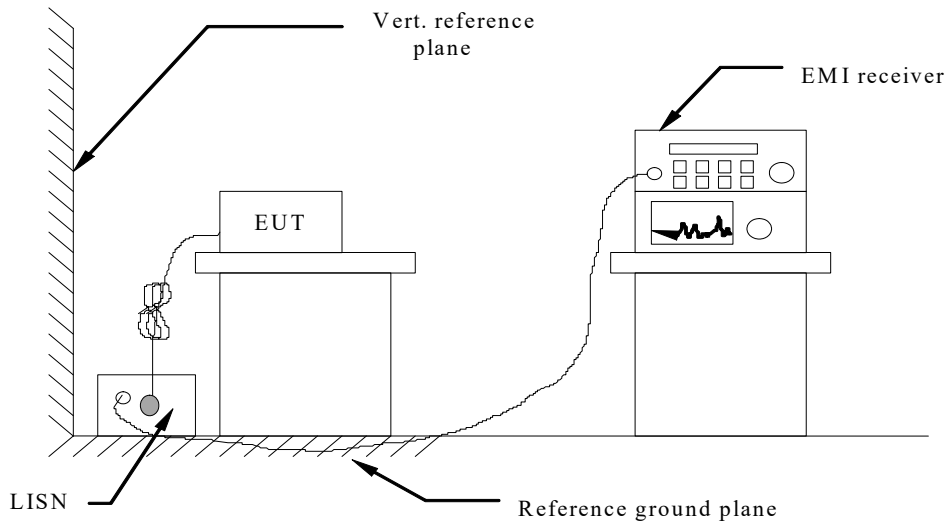

TEST PROCEDURE

- 1 The equipment was set up as per the test configuration to simulate typical actual usage per the user's manual. The EUT is a tabletop system, a wooden table with a height of 0.8 meters is used and is placed on the ground plane as per ANSI C63.10-2013.
- 2 Support equipment, if needed, was placed as per ANSI C63.10-2013
- 3 All I/O cables were positioned to simulate typical actual usage as per ANSI C63.10-2013
- 4 The EUT received power from adapter, the adapter received AC120V/60Hz and AC 240V/60Hz power through a Line Impedance Stabilization Network (LISN) which supplied power source and was grounded to the ground plane.
- 5 All support equipments received AC power from a second LISN, if any.
- 6 The EUT test program was started. Emissions were measured on each current carrying line of the EUT using a spectrum Analyzer / Receiver connected to the LISN powering the EUT. The LISN has two monitoring points: Line 1 (Hot Side) and Line 2 (Neutral Side). Two scans were taken: one with Line 1 connected to Analyzer / Receiver and Line 2 connected to a 50 ohm load; the second scan had Line 1 connected to a 50 ohm load and Line 2 connected to the Analyzer / Receiver.
- 7 Analyzer / Receiver scanned from 150 KHz to 30MHz for emissions in each of the test modes.
- 8 During the above scans, the emissions were maximized by cable manipulation.

AC Power Conducted Emission Limit

For intentional device, according to § 15.207(a) AC Power Conducted Emission Limits is as following:

Frequency range (MHz)	Limit (dBuV)	
	Quasi-peak	Average
0.15-0.5	66 to 56*	56 to 46*
0.5-5	56	46
5-30	60	50

* Decreases with the logarithm of the frequency.

TEST RESULTS

The EUT is powered by car battery, so this test item is not applicable for the EUT.

4.2 Radiated Emissions

Limit

The maximum emissions outside of the frequency bands of operation shall be attenuated in accordance with the following limits:

- (1) For transmitters operating in the 5.15-5.25 GHz band: All emissions outside of the 5.15-5.35 GHz band shall not exceed an e.i.r.p. of -27 dBm/MHz.
- (2) For transmitters operating in the 5.25-5.35 GHz band: All emissions outside of the 5.15-5.35 GHz band shall not exceed an e.i.r.p. of -27 dBm/MHz.
- (3) For transmitters operating in the 5.47-5.725 GHz band: All emissions outside of the 5.47-5.725 GHz band shall not exceed an e.i.r.p. of -27 dBm/MHz.
- (4) For transmitters operating in the 5.725-5.85 GHz band: All emissions shall be limited to a level of -27 dBm/MHz at 75 MHz or more above or below the band edge increasing linearly to 10 dBm/MHz at 25 MHz above or below the band edge, and from 25 MHz above or below the band edge increasing linearly to a level of 15.6 dBm/MHz at 5 MHz above or below the band edge, and from 5 MHz above or below the band edge increasing linearly to a level of 27 dBm/MHz at the band edge.

Undesirable emission limits

Requirement	Limit(EIRP)	Limit (Field strength at 3m) <small>Note1</small>
15.407(b)(1)	PK:-27(dBm/MHz)	PK:68.2(dBµV/m)
15.407(b)(2)		
15.407(b)(3)		
15.407(b)(4)		

Note1: The following formula is used to convert the equipment isotropic radiated power (eirp) to field strength:

$$E = \frac{1000000\sqrt{30P}}{3} \mu\text{V/m, where P is the eirp (Watts)}$$

- (5) Unwanted emissions below 1 GHz must comply with the general field strength limits set forth in §15.209
- (6) In addition, radiated emissions which fall in the restricted bands, as defined in §15.205(a), must also comply with the radiated emission limits specified in §15.209(a)

Radiated emission limits

Frequency (MHz)	Distance (Meters)	Radiated (dBµV/m)	Radiated (µV/m)
0.009-0.49	3	20log(2400/F(KHz))+40log(300/3)	2400/F(KHz)
0.49-1.705	3	20log(24000/F(KHz))+ 40log(30/3)	24000/F(KHz)
1.705-30	3	20log(30)+ 40log(30/3)	30
30-88	3	40.0	100
88-216	3	43.5	150
216-960	3	46.0	200
Above 960	3	54.0	500

TEST CONFIGURATION

(A) Radiated Emission Test Set-Up, Frequency Below 30MHz

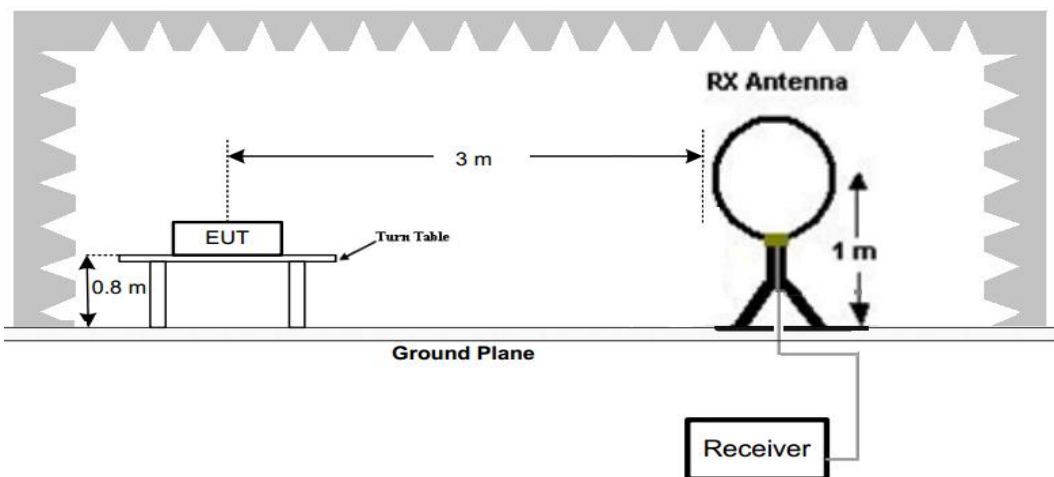

(B) Radiated Emission Test Set-Up, Frequency below 1000MHz

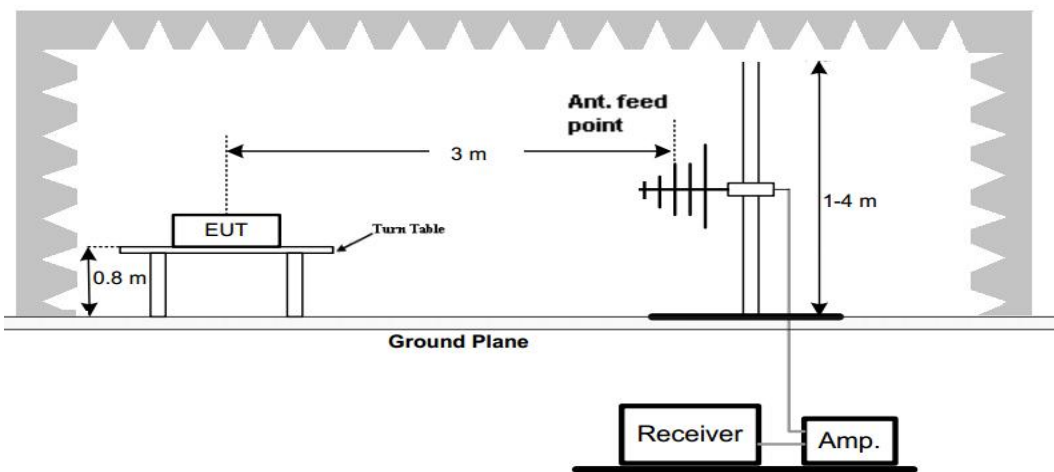

(C) Radiated Emission Test Set-Up, Frequency above 1000MHz

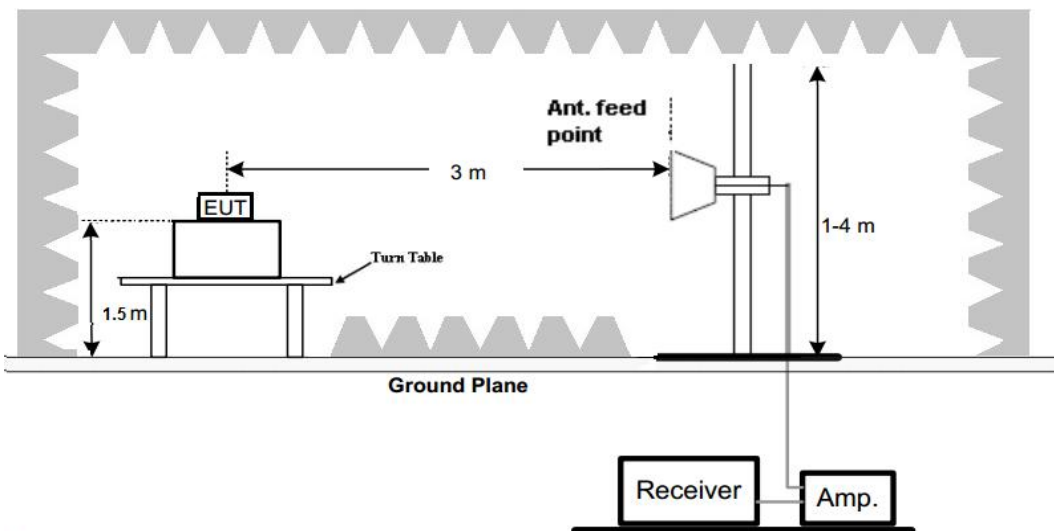

Test Procedure

1. Below 1GHz measurement the EUT is placed on a turntable which is 0.8m above ground plane, and above 1GHz measurement EUT was placed on a low permittivity and low loss tangent turn table which is 1.5m above ground plane.
2. Maximum procedure was performed by raising the receiving antenna from 1m to 4m and rotating the turn table from 0° to 360° to acquire the highest emissions from EUT
3. And also, each emission was to be maximized by changing the polarization of receiving antenna both horizontal and vertical.
4. Repeat above procedures until all frequency measurements have been completed.
5. Radiated emission test frequency band from 9KHz to 40GHz.
6. The distance between test antenna and EUT as following table states:

Test Frequency range	Test Antenna Type	Test Distance
9KHz-30MHz	Active Loop Antenna	3
30MHz-1GHz	Bilog Antenna	3
1GHz-18GHz	Horn Antenna	3
18GHz-25GHz	Horn Antenna	1

7. Setting test receiver/spectrum as following table states:

Test Frequency range	Test Receiver/Spectrum Setting	Detector
9KHz-150KHz	RBW=200Hz/VBW=3KHz, Sweep time=Auto	QP
150KHz-30MHz	RBW=9KHz/VBW=100KHz, Sweep time=Auto	QP
30MHz-1GHz	RBW=120KHz/VBW=1000KHz, Sweep time=Auto	QP
1GHz-40GHz	Peak Value: RBW=1MHz/VBW=3MHz, Sweep time=Auto Average Value: RBW=1MHz/VBW=10Hz, Sweep time=Auto	Peak

TEST RESULTS

Remark:

1. This test was performed with EUT in X, Y, Z position and the worse case was found when EUT in X position.
2. All 802.11a/ 802.11ac(HT20) /802.11ac(HT40) /802.11ac(HT80) / 802.11n (HT20) / 802.11n (HT40) modes have been tested for below 1GHz test, only the worst case 802.11n (HT20) low channel of U-NII 1 band was recorded.
3. All 802.11a/ 802.11ac(HT20) /802.11ac(HT40) /802.11ac(HT80) / 802.11n (HT20) / 802.11n (HT40) modes have been tested for above 1GHz test, only the worst case 802.11n (HT20) was recorded.
4. Radiated emission test from 9 KHz to 10th harmonic of fundamental was verified, and no emission found except system noise floor in 9 KHz to 30MHz and not recorded in this report.

For 30MHz-1GHz

Horizontal

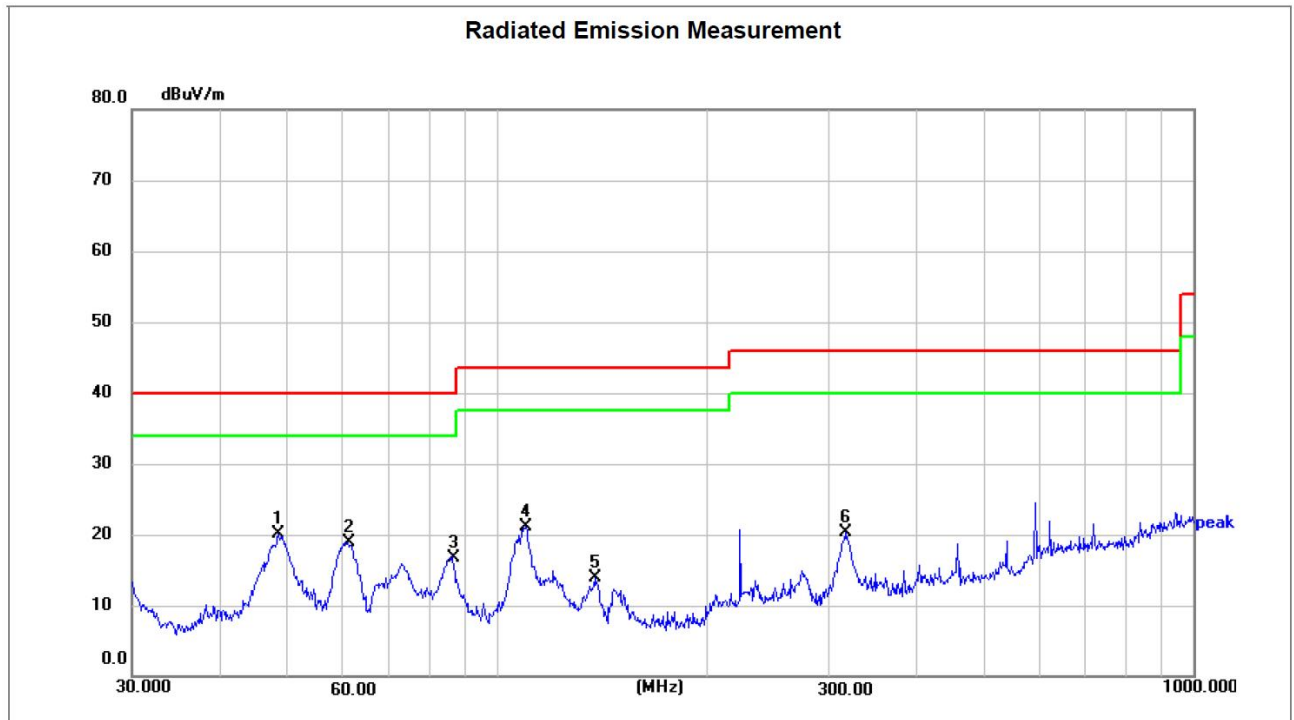

Site LAB
 Limit: FCC Part15 RE-Class B_30-1000MHz
 EUT:
 M/N:
 Mode:
 Note:

Polarization: **Horizontal**
 Power: DC12V
 Distance: 3m

Temperature: 24.5(C)
 Humidity: 52 %

No.	Frequency (MHz)	Reading (dBuV)	Factor (dB/m)	Level (dBuV/m)	Limit (dBuV/m)	Margin (dB)	Detector	Height (cm)	Azimuth (deg.)	P/F	Remark
1 *	48.6719	37.59	-17.49	20.10	40.00	-19.90	peak	100	159	P	
2	61.1316	38.04	-19.15	18.89	40.00	-21.11	peak	100	263	P	
3	86.5029	38.24	-21.44	16.80	40.00	-23.20	peak	200	187	P	
4	110.5202	40.62	-19.48	21.14	43.50	-22.36	peak	200	359	P	
5	138.3873	36.01	-22.07	13.94	43.50	-29.56	peak	200	124	P	
6	316.5890	37.04	-16.83	20.21	46.00	-25.79	peak	200	359	P	

- Note:1).Level (dBμV/m)= Reading (dBμV)+ Factor (dB/m)
 2). Factor(dB/m)=Antenna Factor (dB/m) + Cable loss (dB) - Pre Amplifier gain (dB)
 3). Margin(dB) = Level (dBμV/m) - Limit (dBμV/m)

Vertical

Radiated Emission Measurement

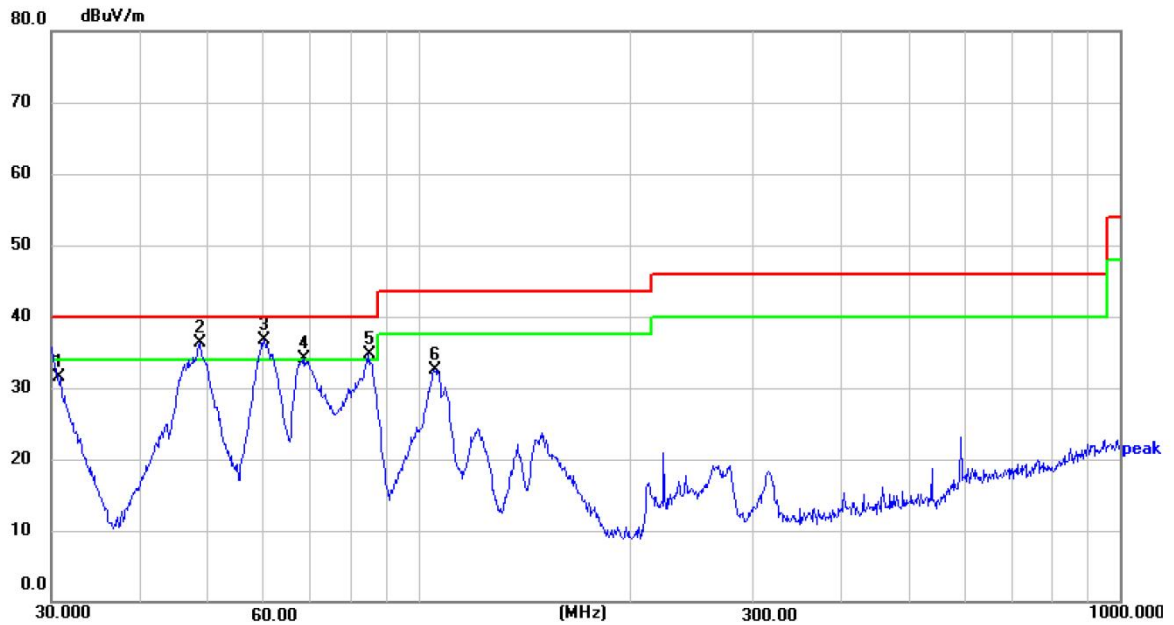

Site LAB Polarization: **Vertical** Temperature: 24.5(C)
 Limit: FCC Part15 RE-Class B_30-1000MHz Power: DC12V Humidity: 52 %
 EUT: Distance: 3m
 M/N:
 Mode:
 Note:

No.	Frequency (MHz)	Reading (dBuV)	Factor (dB/m)	Level (dBuV/m)	Limit (dBuV/m)	Margin (dB)	Detector	Height (cm)	Azimuth (deg.)	P/F	Remark
1	30.6379	51.42	-19.86	31.56	40.00	-8.44	peak	100	39	P	
2 !	48.8427	53.78	-17.48	36.30	40.00	-3.70	peak	100	217	P	
3 *	60.2800	55.64	-18.97	36.67	40.00	-3.33	peak	100	124	P	
4 !	68.8721	54.44	-20.35	34.09	40.00	-5.91	peak	100	154	P	
5 !	84.9995	56.40	-21.77	34.63	40.00	-5.37	peak	100	263	P	
6	105.2718	51.72	-19.17	32.55	43.50	-10.95	peak	100	1	P	

Note:1).Level (dBuV/m)= Reading (dBuV)+ Factor (dB/m)

2). Factor(dB/m)=Antenna Factor (dB/m) + Cable loss (dB) - Pre Amplifier gain (dB)

3). Margin(dB) = Level (dBuV/m) - Limit (dBuV/m)

REMARKS:

1. Emission level (dBuV/m) =Raw Value (dBuV)+Correction Factor (dB/m)
2. Correction Factor (dB/m) = Antenna Factor (dB/m)+Cable Factor (dB)-Pre-amplifier Factor
3. Margin value = Limit value- Emission level.
4. -- Mean the other emission levels were very low against the limit.
5. RBW1MHz VBW3MHz Peak detector is for PK value; RBW 1MHz VBW10Hz Peak detector is for AV value.
6. Worst case data at 6Mbps at IEEE 802.11a, MCS0 at IEEE 802.11n HT20, IEEE 802.11n HT40, IEEE 802.11ac VHT20 ,IEEE 802.11ac VHT40 and IEEE 802.11ac VHT80.

4.3 Maximum Conducted Average Output Power

Limit

For the band 5.15-5.25 GHz.

(i) For an outdoor access point operating in the band 5.15-5.25 GHz, the maximum conducted output power over the frequency band of operation shall not exceed 1 W provided the maximum antenna gain does not exceed 6 dBi.

(ii) For an indoor access point operating in the band 5.15-5.25 GHz, the maximum conducted output power over the frequency band of operation shall not exceed 1 W provided the maximum antenna gain does not exceed 6 dBi.

(iii) For fixed point-to-point access points operating in the band 5.15-5.25 GHz, the maximum conducted output power over the frequency band of operation shall not exceed 1 W.

(iv) For client devices in the 5.15-5.25 GHz band, the maximum conducted output power over the frequency band of operation shall not exceed 250 mW provided the maximum antenna gain does not exceed 6 dBi.

For the 5.25-5.35 GHz and 5.47-5.725 GHz bands, the maximum conducted output power over the frequency bands of operation shall not exceed the lesser of 250 mW or $11 \text{ dBm} + 10 \log B$, where B is the 26 dB emission bandwidth in megahertz.

For the band 5.725-5.85 GHz, the maximum conducted output power over the frequency band of operation shall not exceed 1 W

Test Procedure

Remove the antenna from the EUT and then connect a low loss RF cable from the antenna port to the power sensor.

Test Configuration

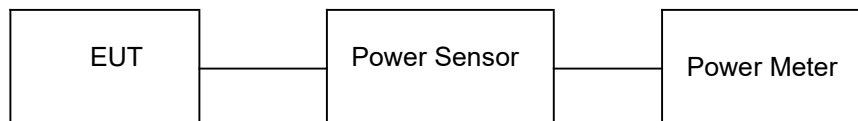

Test Results

U-NII 1

Type	Channel	Output power (dBm)	Limit (dBm)	Result
802.11a	36	7.24	30	Pass
	40	7.79		
	48	8.46		
802.11n(HT20)	36	7.02	30	Pass
	40	7.20		
	48	8.27		
802.11n(HT40)	38	4.46	30	Pass
	46	4.98		
802.11ac(HT20)	36	7.41	30	Pass
	40	7.67		
	48	8.10		
802.11ac(HT40)	38	5.27	30	Pass
	46	5.34		
802.11ac(HT80)	42	8.02	30	Pass

U-NII 3

Type	Channel	Output power (dBm)	Limit (dBm)	Result
802.11a	149	6.57	30.00	Pass
	157	5.84		
	165	5.71		
802.11n(HT20)	149	6.23	30.00	Pass
	157	5.83		
	165	5.29		
802.11n(HT40)	151	4.84	30.00	Pass
	159	4.75		
802.11ac(HT20)	149	5.72	30.00	Pass
	157	5.47		
	165	5.93		
802.11ac(HT40)	151	3.76	30.00	Pass
	159	2.01		
802.11ac(HT80)	155	5.60	30.00	Pass

4.4 Power Spectral Density

Limit

(1) For the band 5.15 - 5.25 GHz.

(i) For an outdoor access point operating in the band 5.15 - 5.25 GHz, the maximum power spectral density shall not exceed 17 dBm in any 1 MHz band.^{note1}

(ii) For an indoor access point operating in the band 5.15 - 5.25 GHz, the maximum power spectral density shall not exceed 17 dBm in any 1 MHz band.^{note1}

(iii) For fixed point-to-point access points operating in the band 5.15 - 5.25 GHz, transmitters that employ a directional antenna gain greater than 23 dBi, a 1 dB reduction in maximum power spectral density is required for each 1 dB of antenna gain in excess of 23 dBi.

(iv) For mobile and portable client devices in the 5.15 - 5.25 GHz band, the maximum power spectral density shall not exceed 11 dBm in any 1 MHz band.^{note1}

(2) For the 5.25 - 5.35 GHz and 5.47 - 5.725 GHz bands, the peak power spectral density shall not exceed 11 dBm in any 1 MHz band.^{note1}

(3) For the band 5.725 - 5.85 GHz, the maximum power spectral density shall not exceed 30 dBm in any 500 kHz band.^{note1, note2}

Note1: If transmitting antennas of directional gain greater than 6 dBi are used, the peak power spectral density shall be reduced by the amount in dB that the directional gain of the antenna exceeds 6 dBi.

Note2: Fixed point - to-point U-NII devices operating in this band may employ transmitting antennas with directional gain greater than 6 dBi without any corresponding reduction in transmitter conducted power. Fixed, point-to-point operations exclude the use of point-to-multipoint systems, omnidirectional applications, and multiple collocated transmitters transmitting the same information.

Test Procedure

1. Use this procedure when the maximum peak conducted output power in the fundamental emission is used to demonstrate compliance.
2. Set the RBW = 1MHz for U-NII 1, U-NII 2A, U-NII C band and 510KHz for U-NII 3 band.
3. Set the VBW $\geq 3 \times$ RBW.
4. Set the span to encompass the entire EBW.
5. Detector = peak.
6. Sweep time = auto couple.
7. Trace mode = max hold.
8. Allow trace to fully stabilize.
9. Use the peak marker function to determine the maximum power level.

Test Configuration



Test Results

Type	Bands	Channel	Power Spectral Density (dBm/MHz)	Limit (dBm/MHz)	Result
802.11a	U-NII 1	36	4.43	17	Pass
		40	4.42		
		48	5.53		
802.11n (HT20)	U-NII 1	36	4.54		
		40	3.42		
		48	3.19		
802.11n (HT40)	U-NII 1	38	2.06		
		46	3.08		
802.11ac (HT20)	U-NII 1	36	3.47		
		40	3.87		
		48	5.21		
802.11ac (HT40)	U-NII 1	38	2.22		
		46	4.18		
802.11ac (HT80)	U-NII 1	42	-0.14		

Type	Bands	Channel	Power Spectral Density (dBm/300KHz)	Power Spectral Density (dBm/500KHz)	Limit (dBm/500KHz)	Result
802.11a	U-NII 3	149	0.35	2.57	30	Pass
		157	-1.54	0.68		
		165	-0.80	1.42		
802.11n (HT20)	U-NII 3	149	0.51	2.73		
		157	-1.59	0.63		
		165	-0.69	1.53		
802.11n (HT40)	U-NII 3	151	-0.59	1.63		
		159	-2.06	0.16		
802.11ac (HT20)	U-NII 3	149	0.60	2.82		
		157	-1.93	0.29		
		165	0.21	2.43		
802.11ac (HT40)	U-NII 3	151	-0.18	2.04		
		159	-3.18	-0.96		
802.11ac (HT80)	U-NII 3	155	-4.59	-2.37		

Remark: P.S.D(dBm/500KHz)= P.S.D(dBm/300KHz)+10 log (500 kHz/300KHz).

Test plot as follows

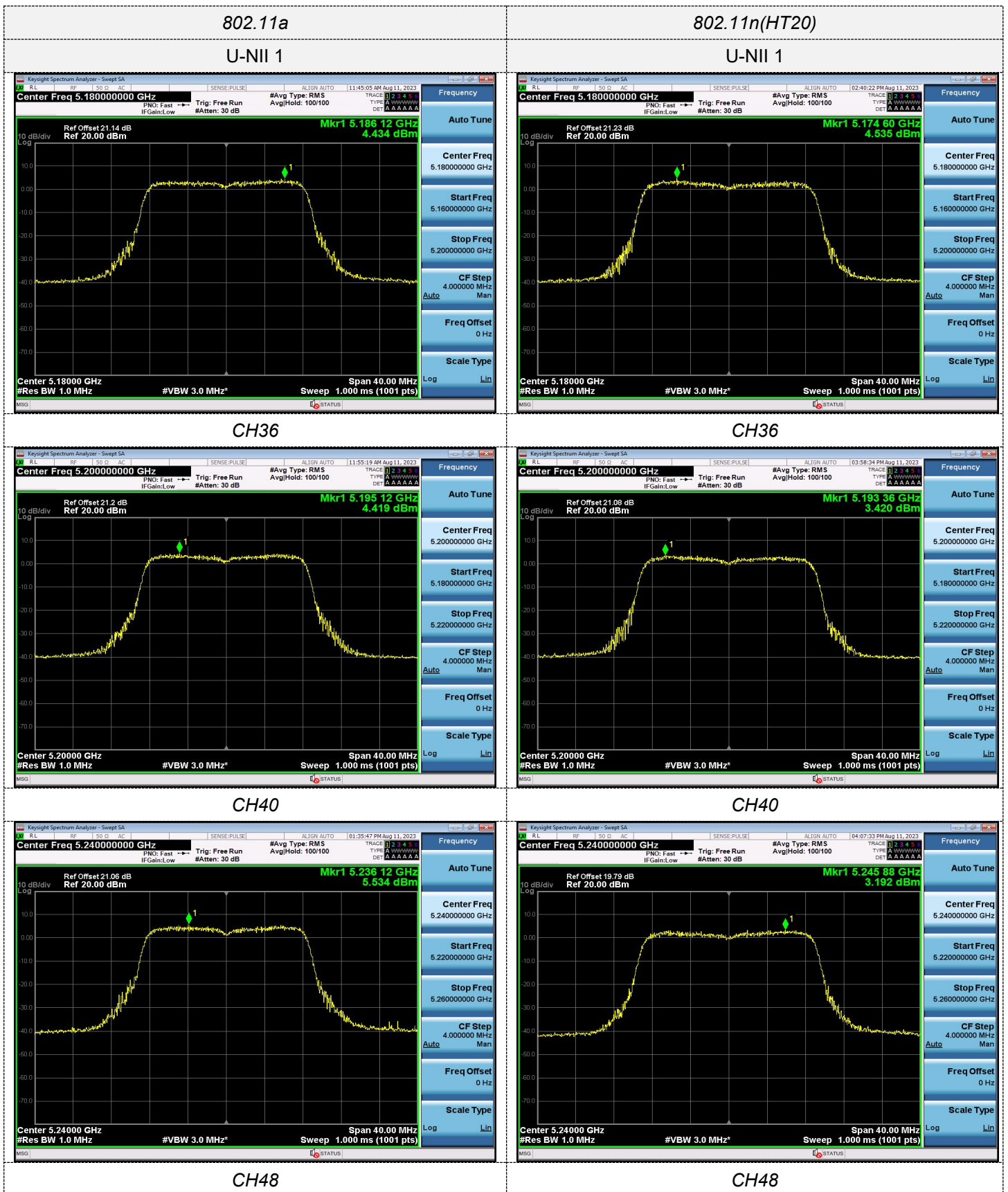

802.11n(HT40)

U-NII 1

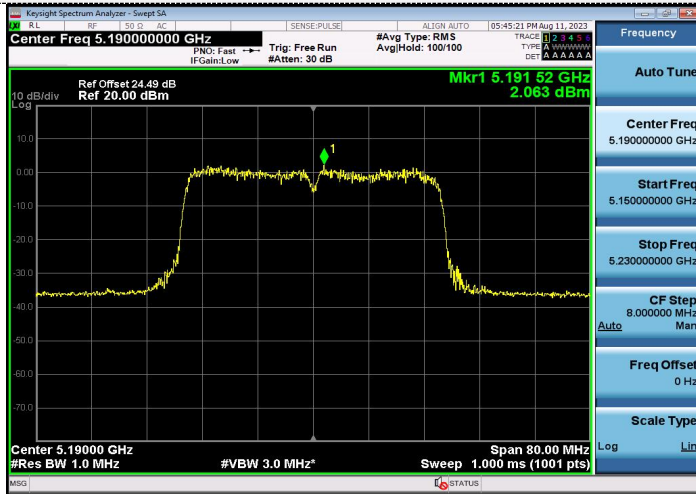

802.11ac(HT20)

U-NII 1



CH38

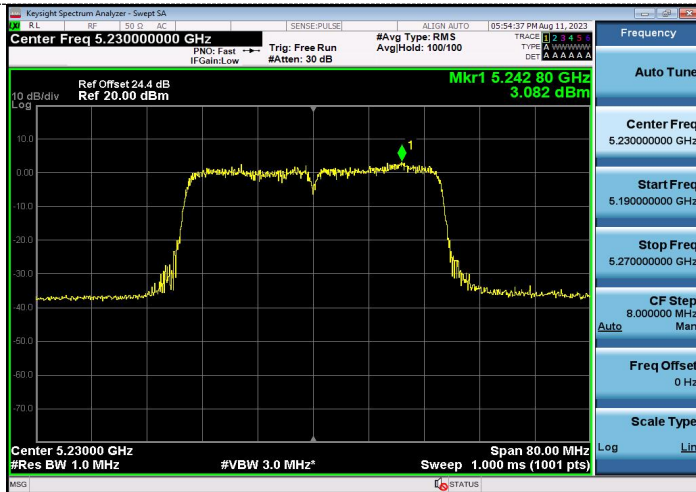

CH36

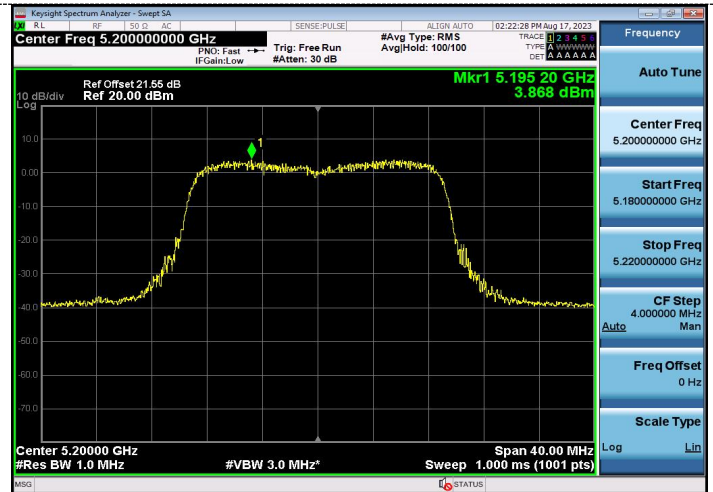

CH46



CH40

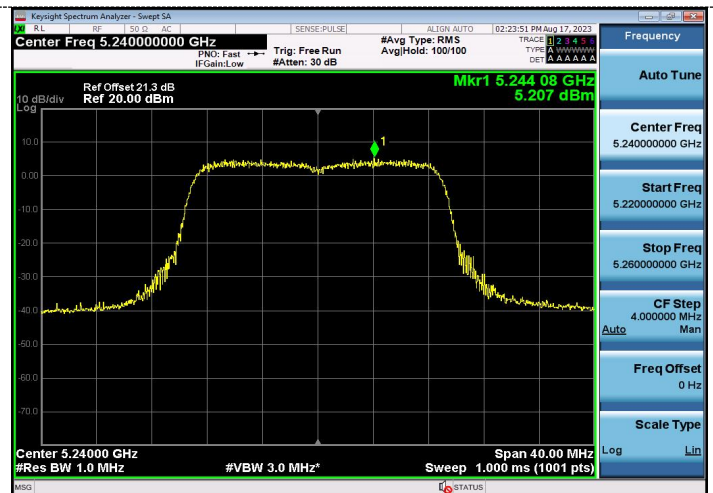

CH48

802.11ac(HT40)

U-NII 1

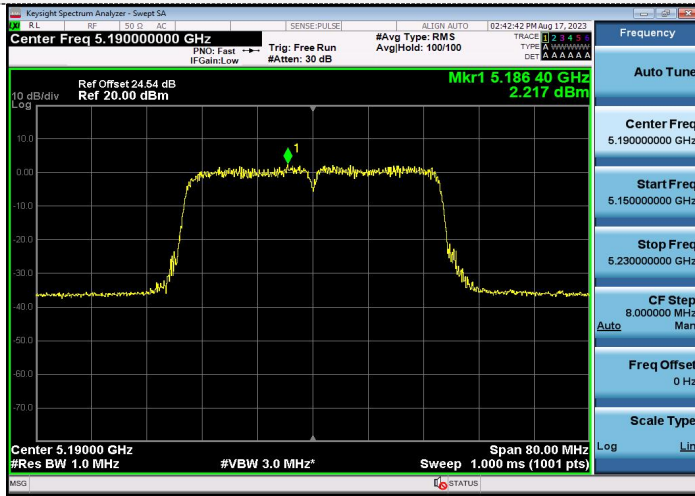

802.11ac(HT80)

U-NII 1

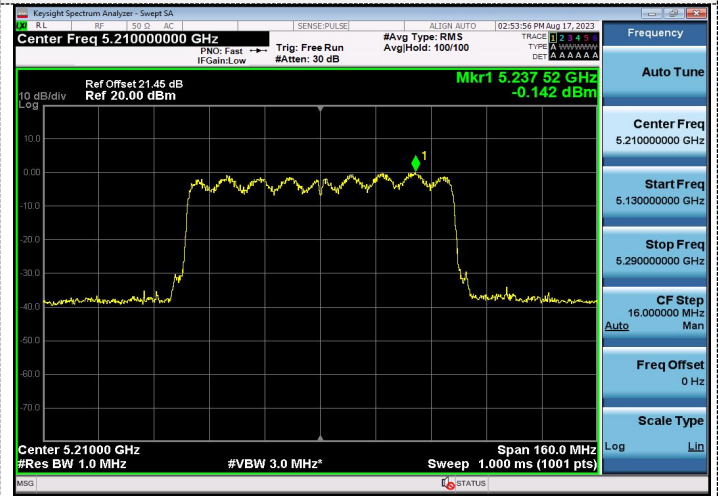

CH38

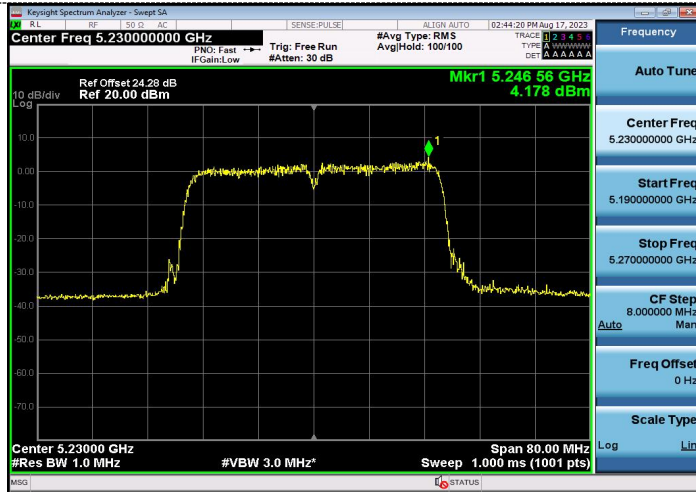

CH42

CH46

802.11a

U-NII 3

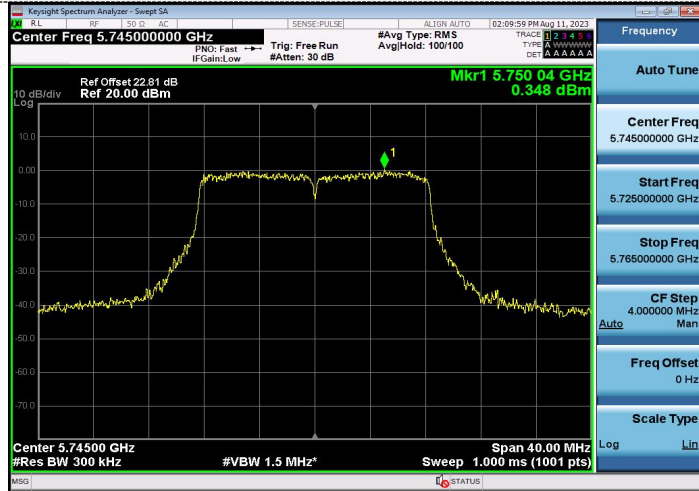

802.11n(HT20)

U-NII 3

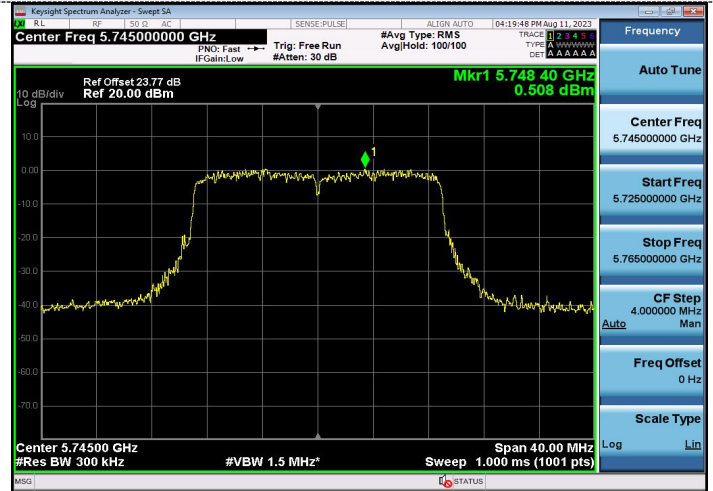

CH149

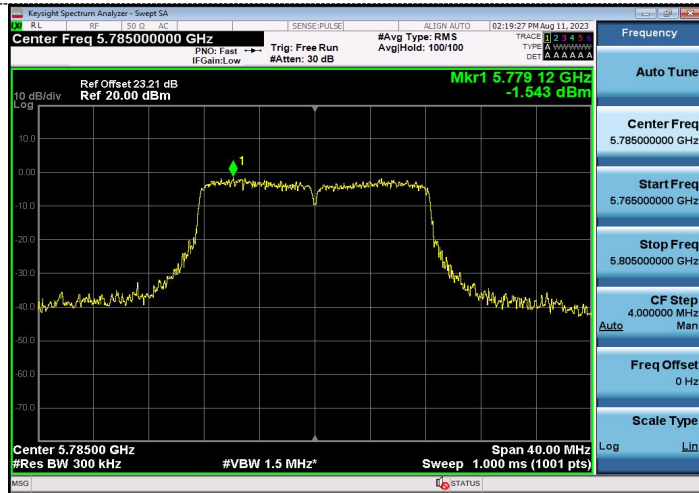

CH149

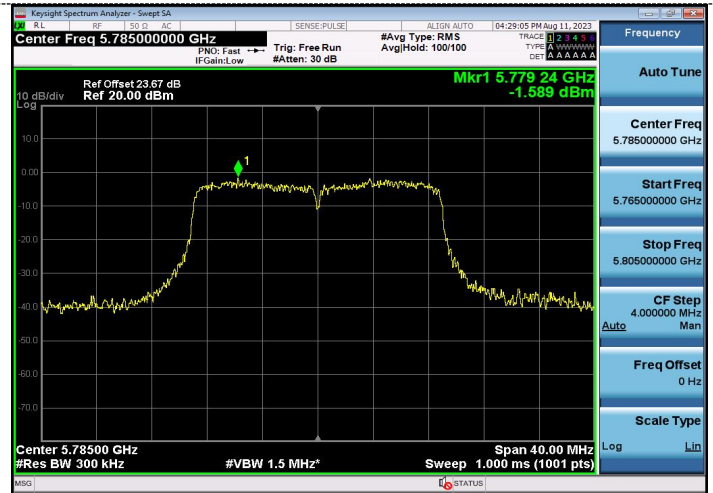

CH157

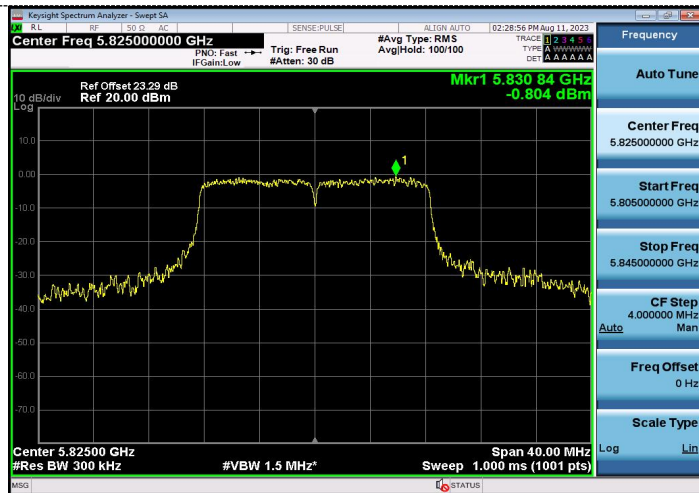

CH157



CH165

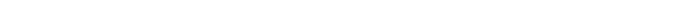

CH165

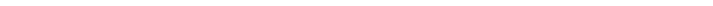

802.11n(HT40)

U-NII 3



802.11ac(HT20)

U-NII 3



CH151



CH149

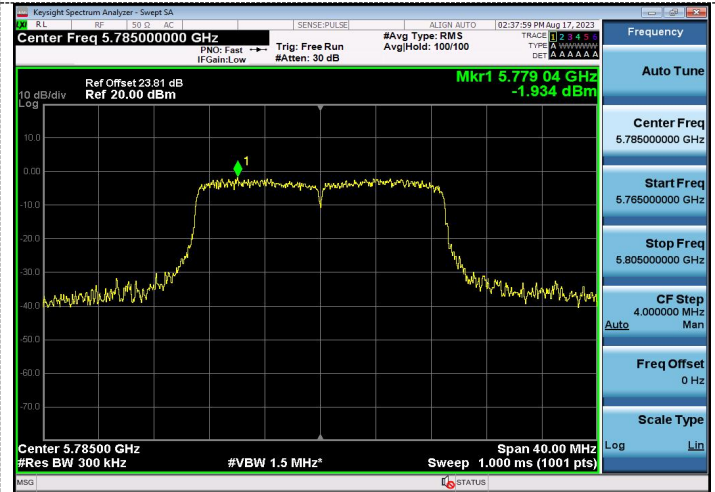

CH159

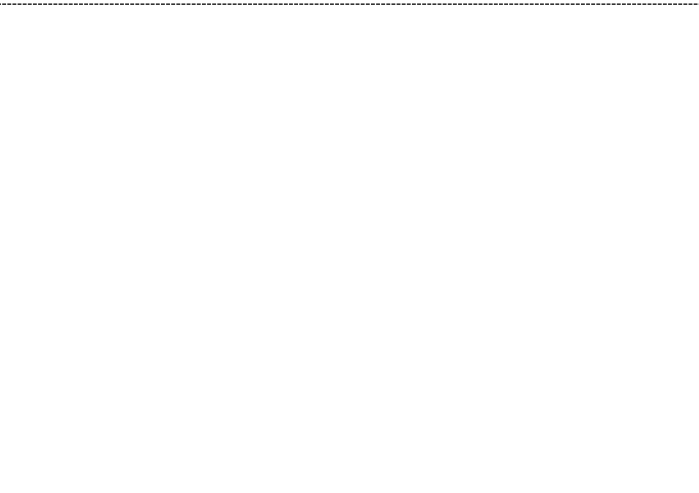

CH157

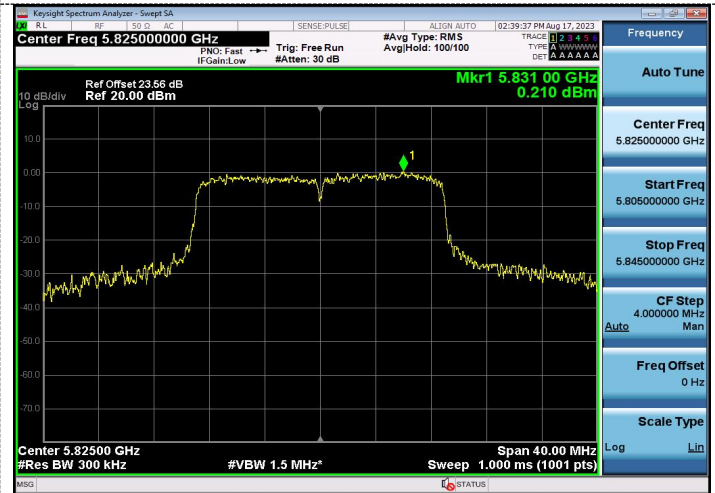

CH165

802.11ac(HT40)

U-NII 3



802.11ac(HT80)

U-NII 3

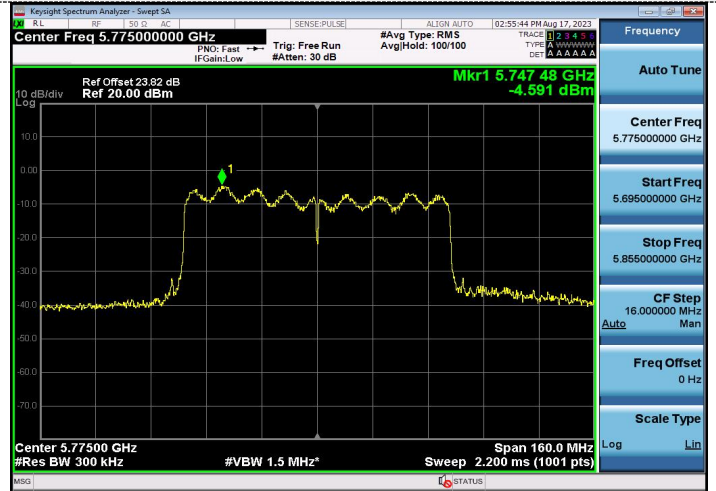

CH151

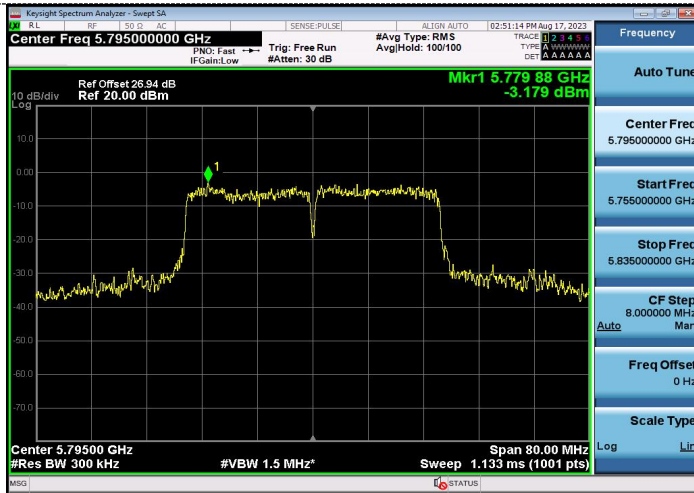

CH159

CH155

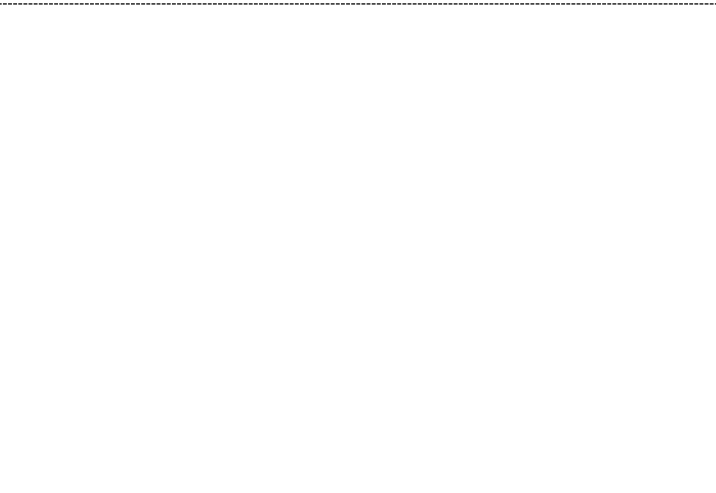

4.5 Emission Bandwidth (26dB Bandwidth)

Limit

N/A

Test Procedure

1. Set resolution bandwidth (RBW) = approximately 1 % of the EBW.
2. Set the video bandwidth (VBW) > RBW.
3. Detector = Peak.
4. Trace mode = Max hold.
5. Measure the maximum width of the emission that is 26 dB down from the peak of the emission. Compare this with the RBW setting of the analyzer. Readjust RBW and repeat measurement as needed until the RBW / EBW ratio is approximately 1 %.

Test Configuration



Test Results

Type	Bands	Channel	26dB Bandwidth (MHz)	Limit (MHz)	Result
802.11a	U-NII 1	36	20.96	N/A	Pass
		40	21.49		
		48	21.65		
802.11n(HT20)	U-NII 1	36	21.68		
		40	21.85		
		48	21.83		
802.11n(HT40)	U-NII 1	38	41.67		
		46	43.49		
802.11ac(HT20)	U-NII 1	36	21.53		
		40	21.69		
		48	21.72		
802.11ac(HT40)	U-NII 1	38	42.35		
		46	41.80		
802.11ac(HT80)	U-NII 1	42	89.04		