

Dongguan ante Communication Co., Ltd

Antenna test report

Customers	Shenzhen Sanjiang Lechuang Technology Co., Ltd.	Project	E1DU0
Frequency band	2.4G-5.8G	Version	
Antenna engineer	Wu Huiqin	Date	2022-06-23



1. Test Equipment

Vector Network Analyzer	Agilent E5071B
Darkroom	OTA-500
Tester	Liu Yunhai

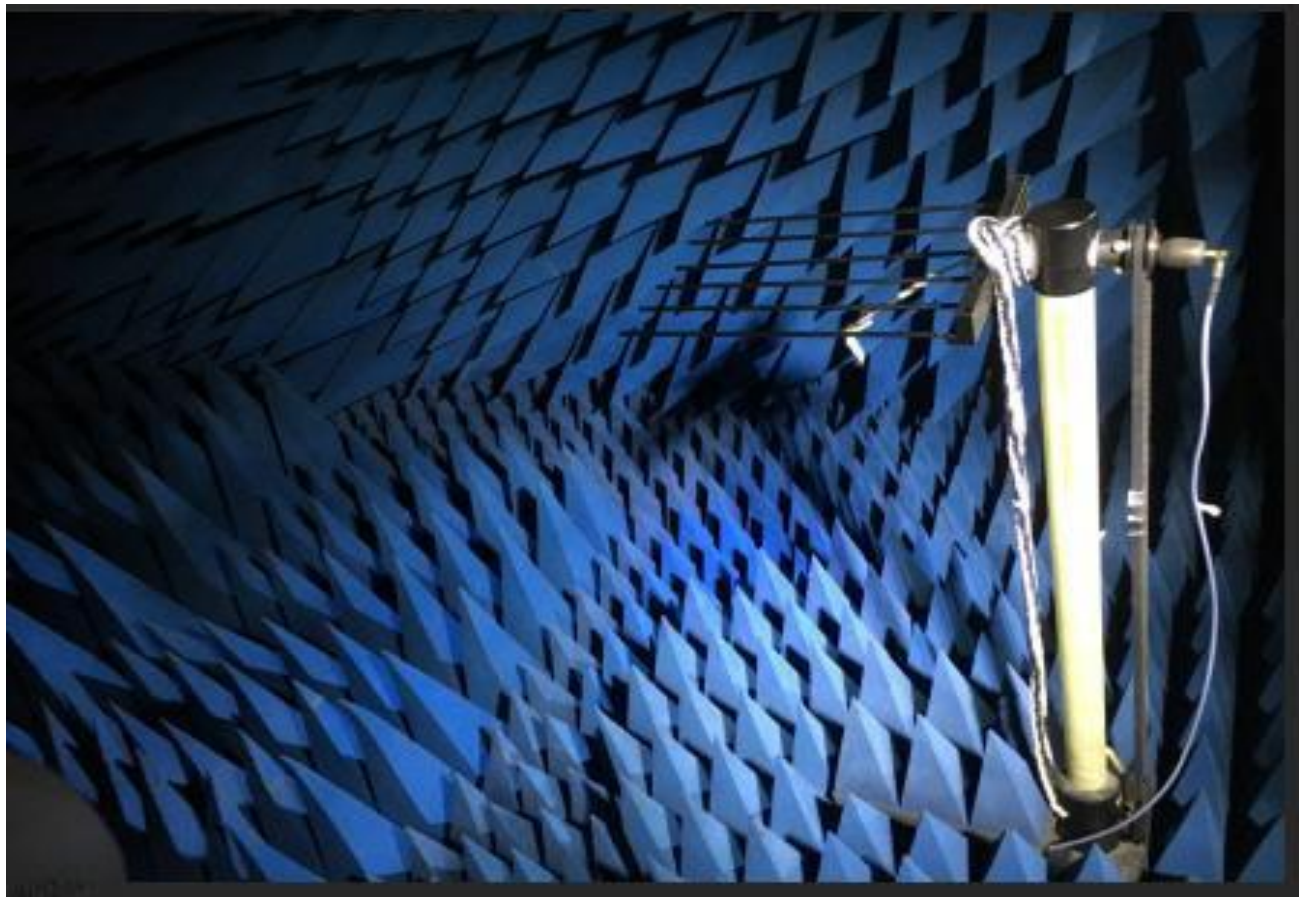

2. Matching circuit

The match hasn't changed.

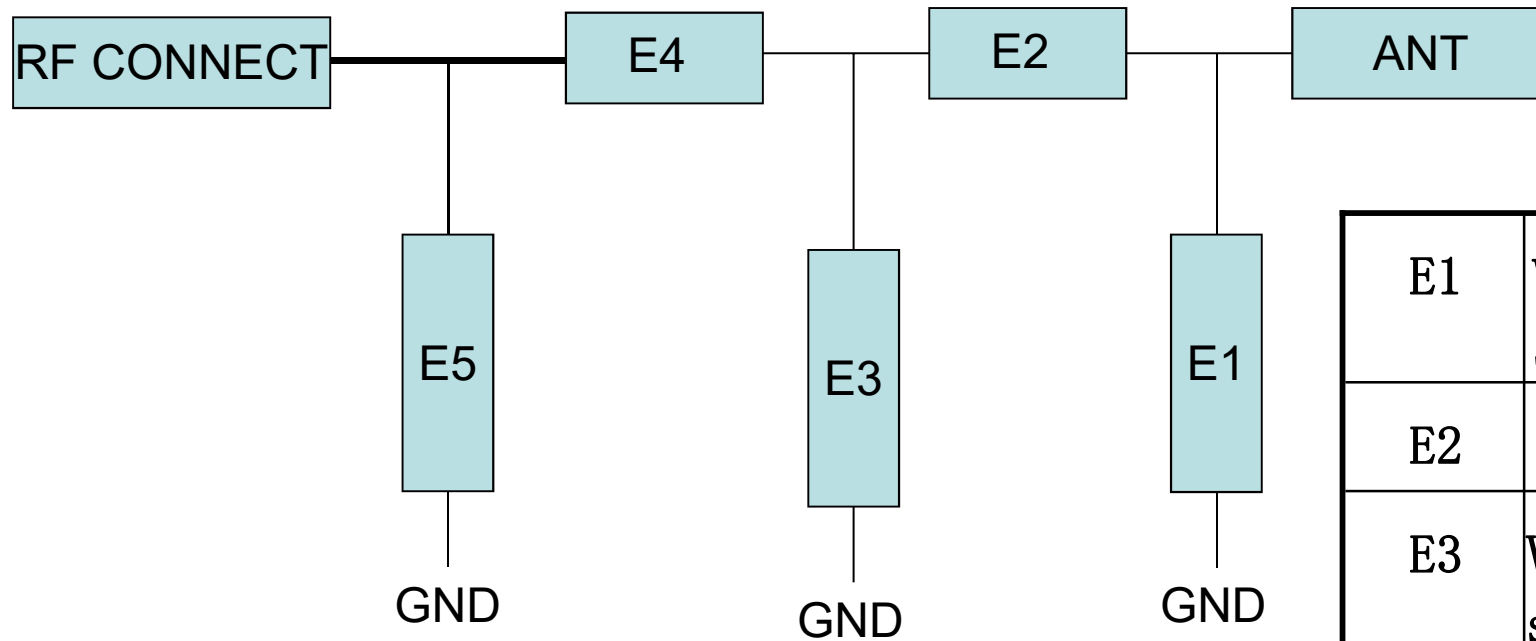

E1	Vacant space
E2	0 ohm
E3	Vacant space
E4	0 ohm
E5	Vacant space

3. Position of antenna



RTANT

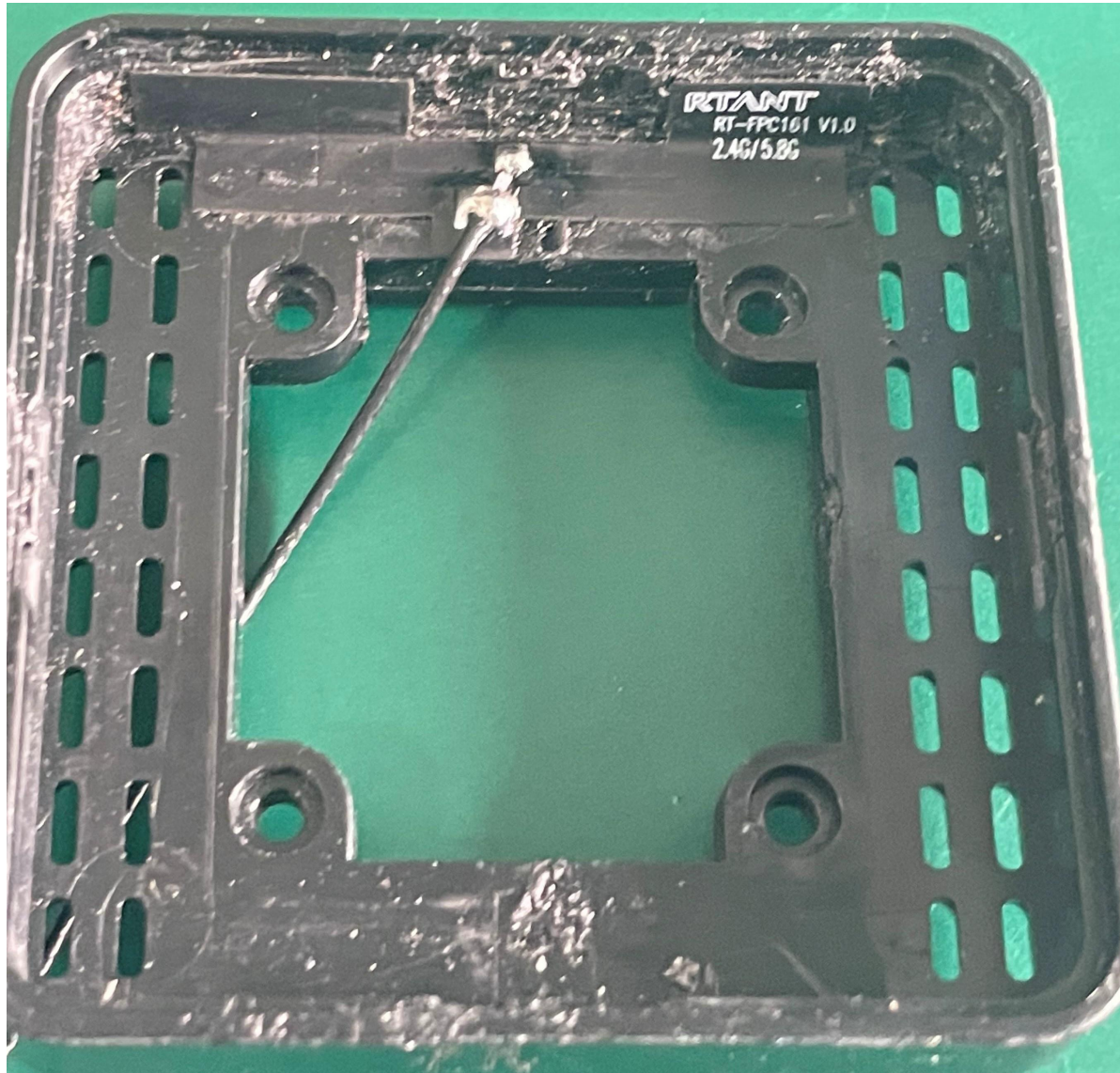

4.R-LOSS, VSWR,

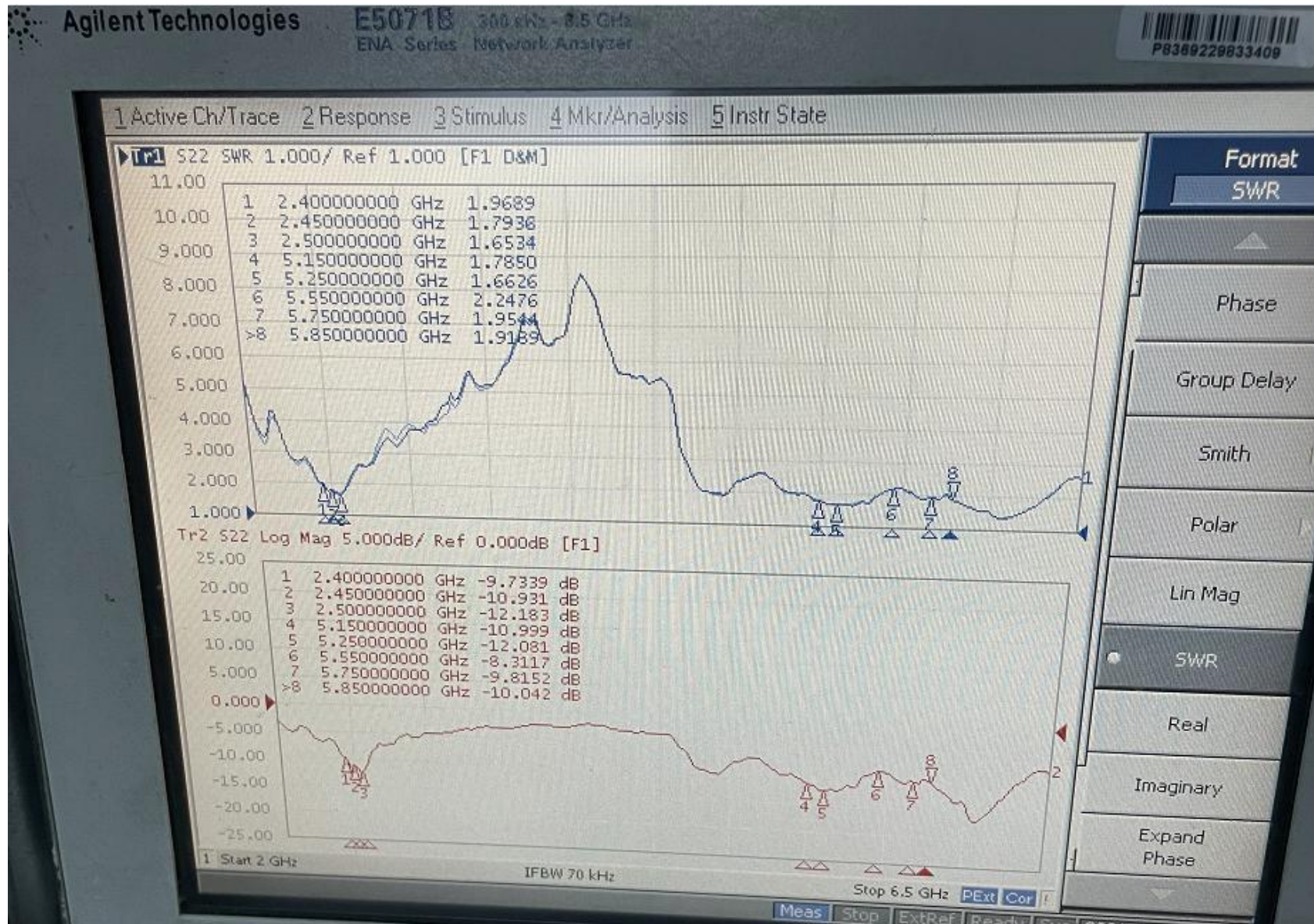



5. Passive test data

Frequency	2. 4GHz	2. 41GHz	2. 42GHz	2. 43GHz	2. 44GHz	2. 45GHz	2. 46GHz	2. 47GHz	2. 48GHz	2. 49GHz	2. 5GHz
Efficiency (%)	41.57	41.74	42.16	41.45	43.57	40.61	42.74	41.63	39.97	43.68	40.07
Gain (dBi)	2.07	2.23	2.29	2.24	2.29	2.07	2.03	2.31	2.19	2.23	2.11

Frequency	5. 15GHz	5. 2GHz	5. 25GHz	5. 3GHz	5. 35GHz	5. 4GHz	5. 45GHz	5. 5GHz	5. 55GHz	5. 6GHz	5. 65GHz
Efficiency (%)	56.81	58.53	60.43	57.24	58.09	57.1	61.64	53.13	52.21	59.11	56.81
Gain (dBi)	2.58	2.61	2.6	2.78	2.83	2.56	2.66	2.36	2.01	2.66	2.57

Frequency	5. 7GHz	5. 75GHz	5. 8GHz	5. 85GHz
Efficiency (%)	59.25	57.24	55.85	51.62
Gain (dBi)	2.41	2.46	2.48	2.2



6.Active test data

TEST DATA FOR RADIATED TESTING							
BAND	MODE	TX RATE	CHANNEL	TRP	RX RATE	CHANEL	TIS
2.4G	11b	11M	1	12.73	11M	1	-81.27
		11M	7	13.71	11M	7	-82.41
		11M	13	13.44	11M	13	-81.96
	11a	6M	36	12.18	54M	36	-70.85
		6M	149	12.69	54M	149	-70.13
		6M	157	13.04	54M	157	-69.03



7. Directional pattern (2.45G)

Theta

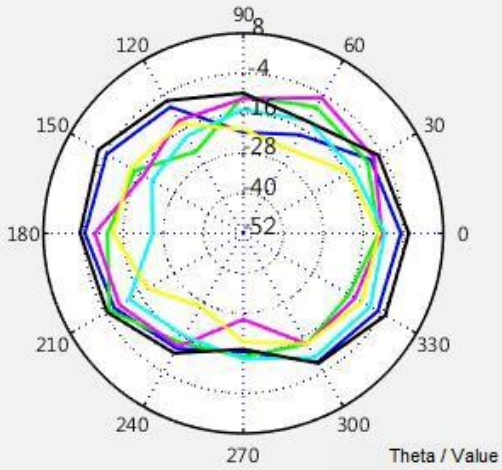

Total

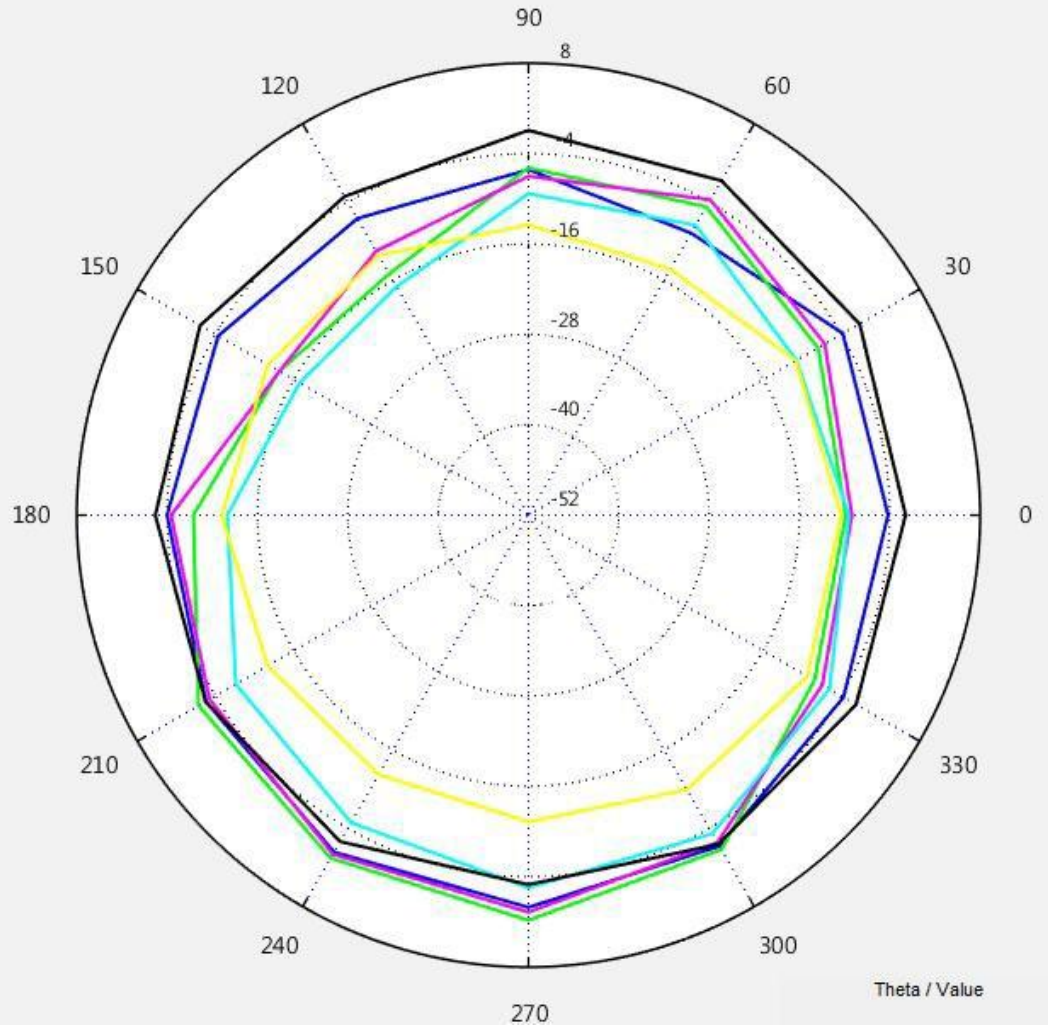

Phi

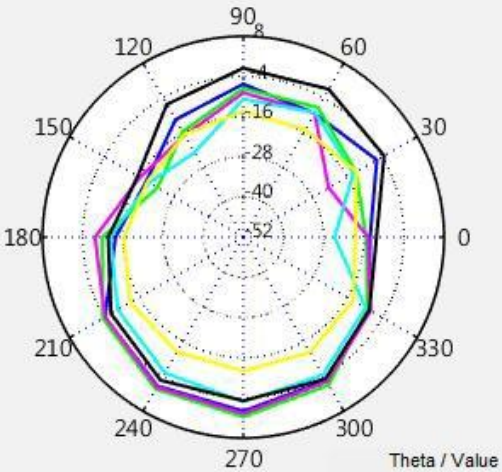

Directional pattern(2.45G)



Theta

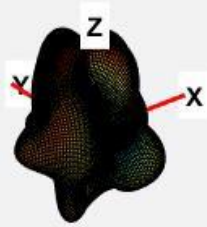

Phi

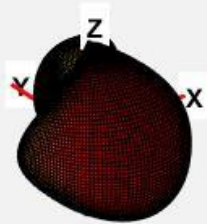

Total

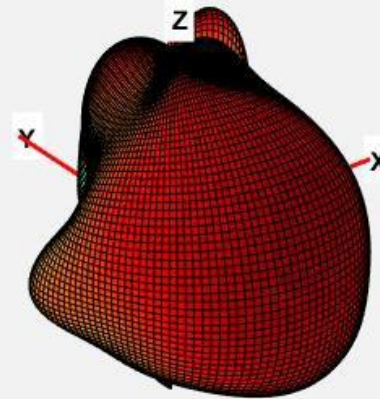

Directional pattern(5.15G)

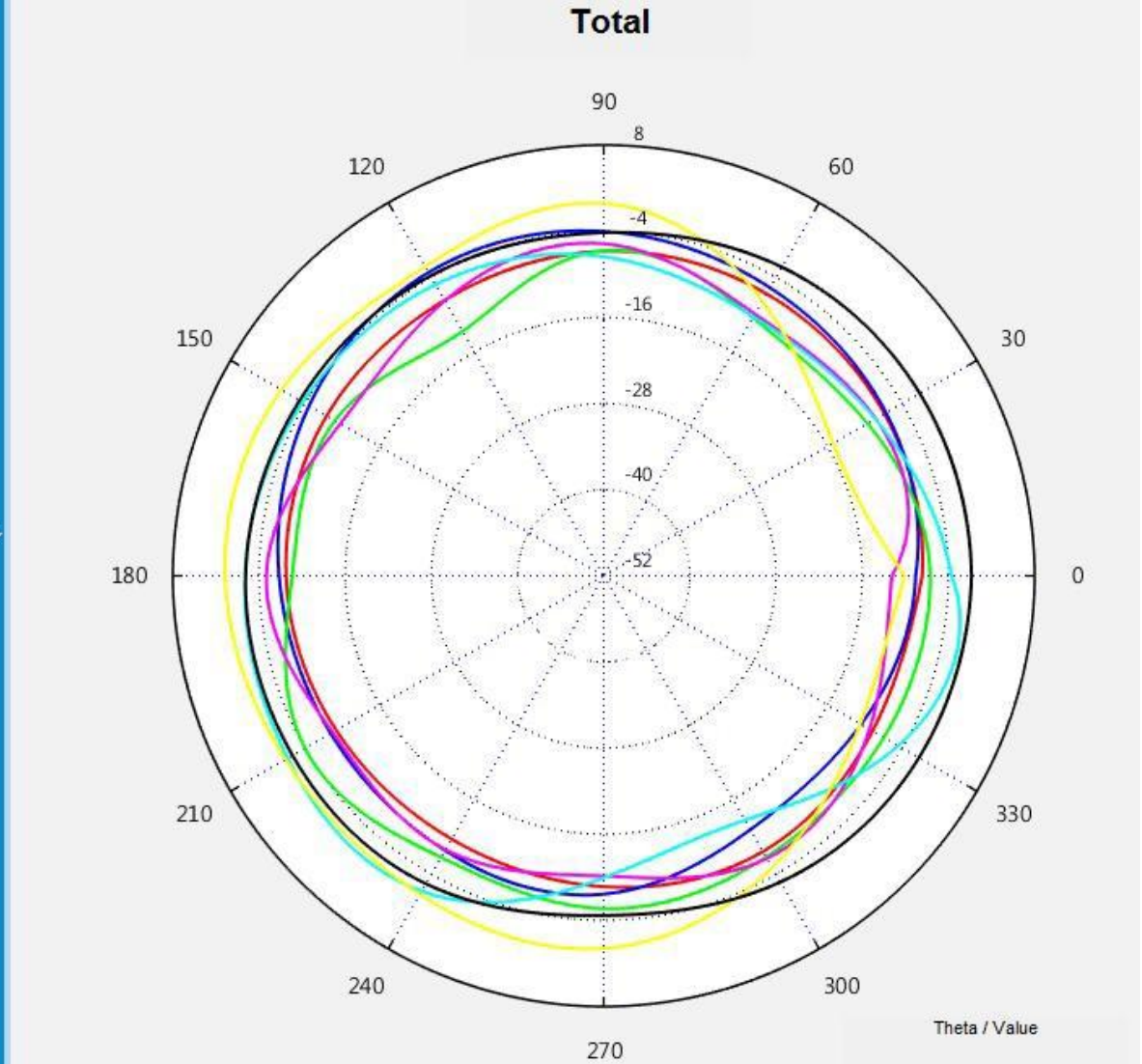
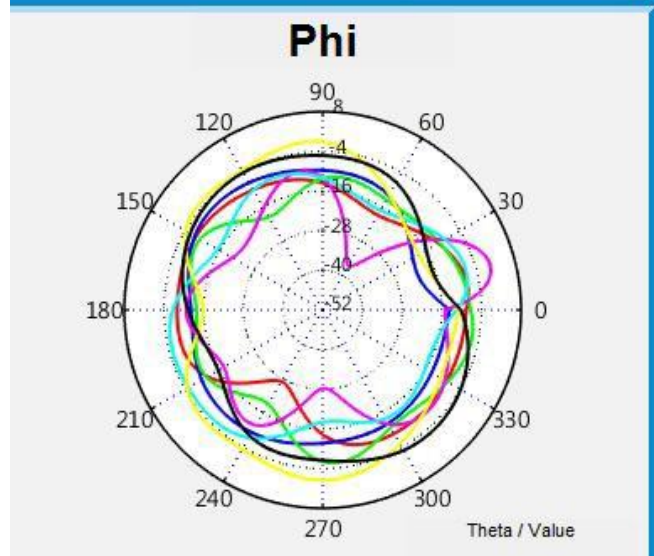
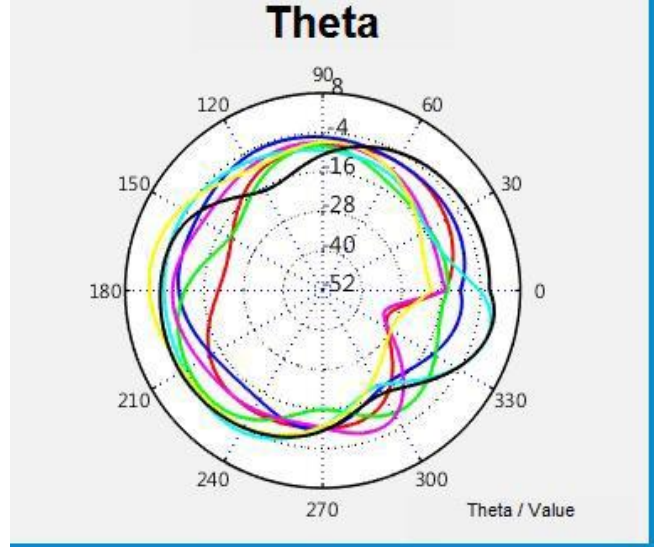

Directional pattern (5.15G)

Theta

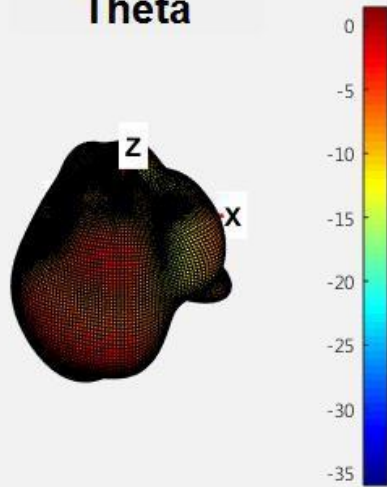

Phi

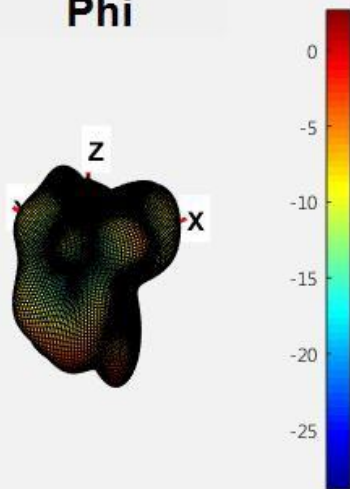

Total

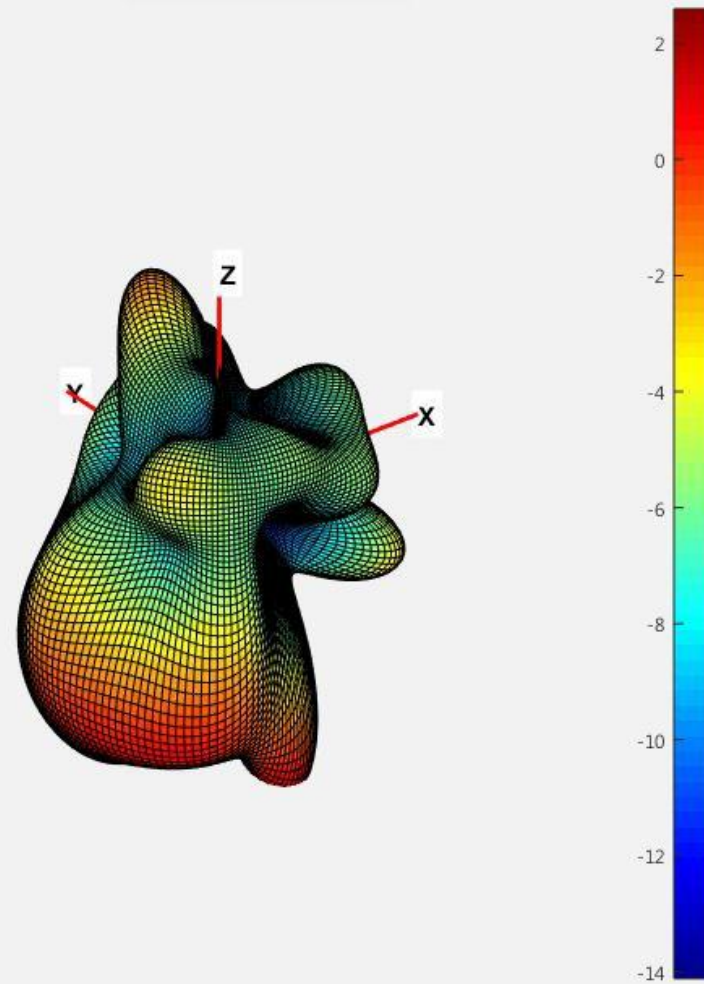

Directional pattern(5.5G)

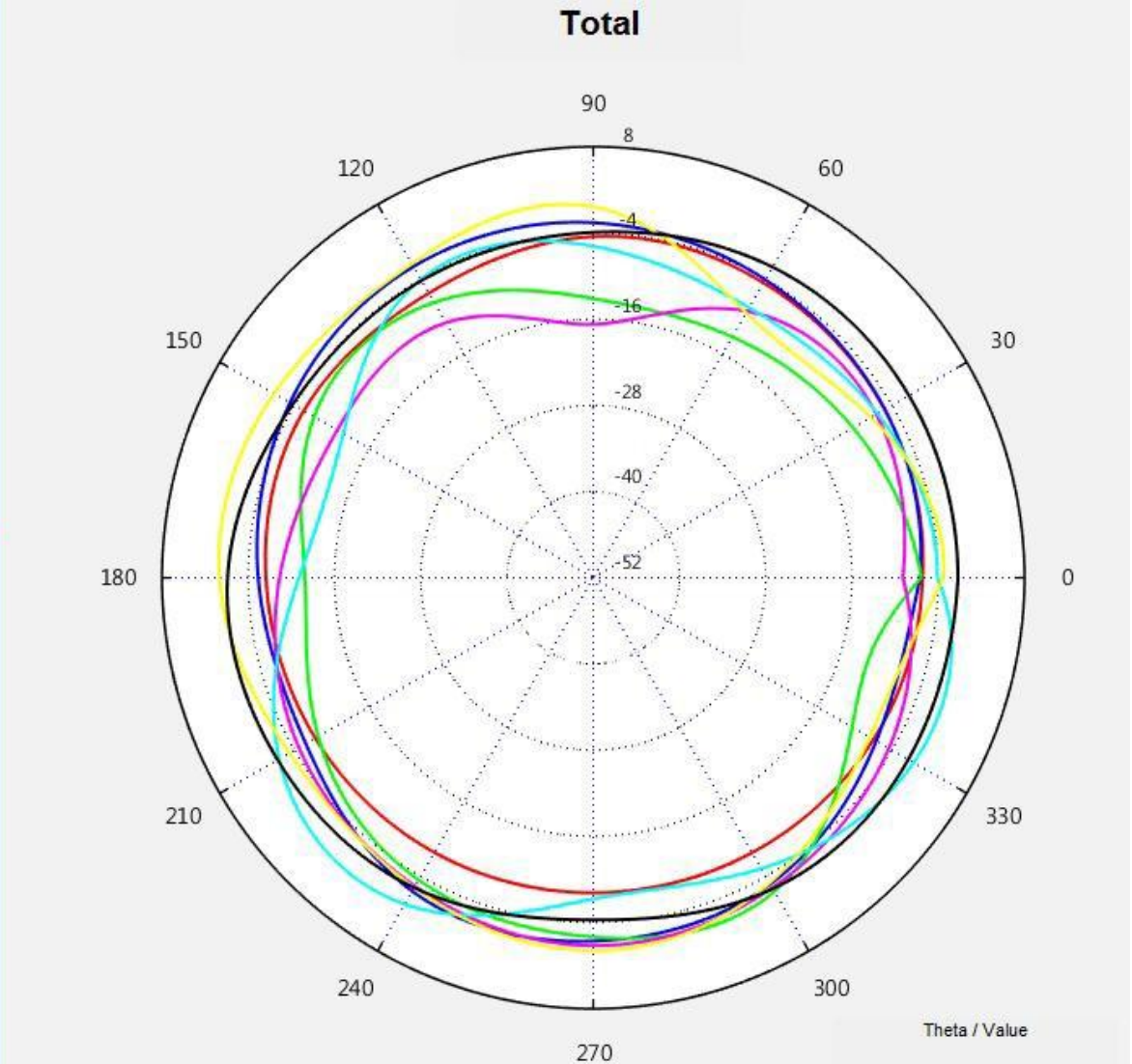
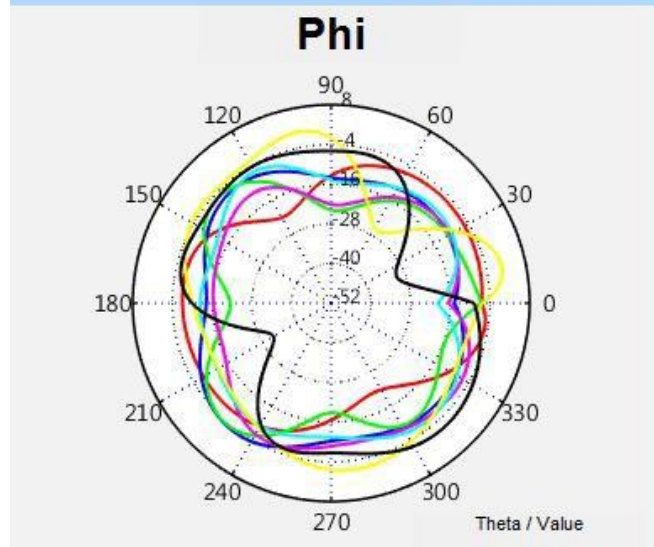
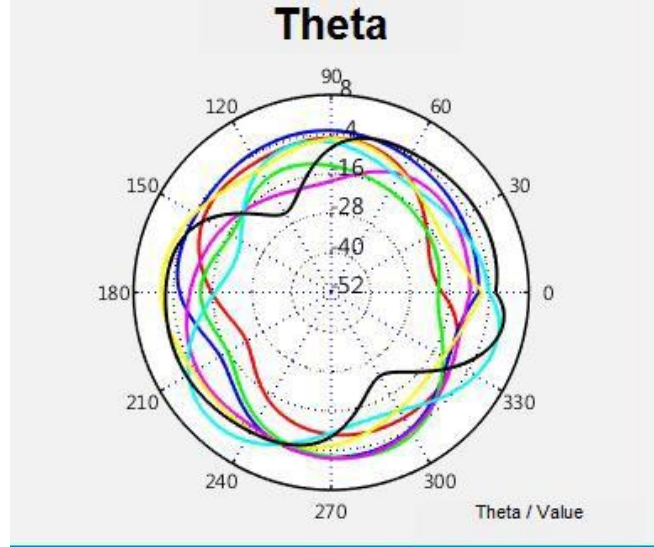

Directional pattern(5.5G)

Theta

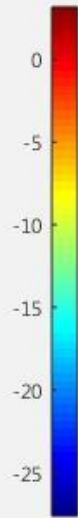
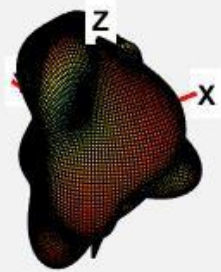

Total

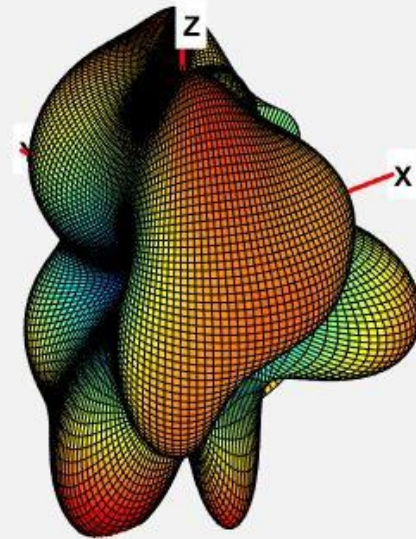

Phi

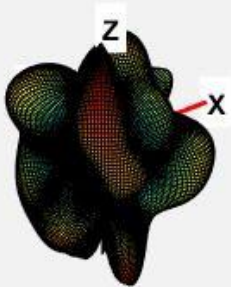



Directional pattern (5.85G)

Theta

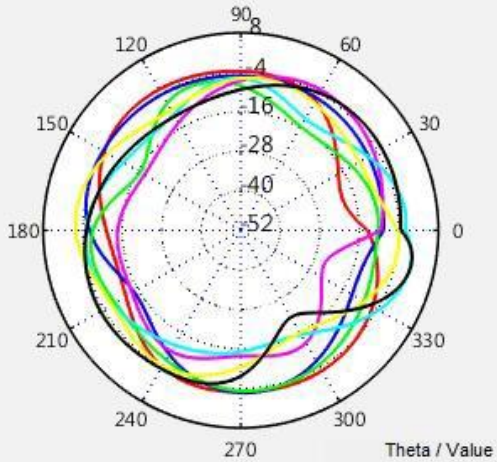

Theta / Value

Phi

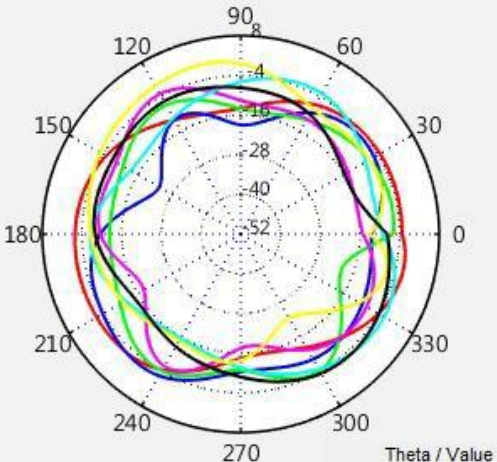

Theta / Value

Total

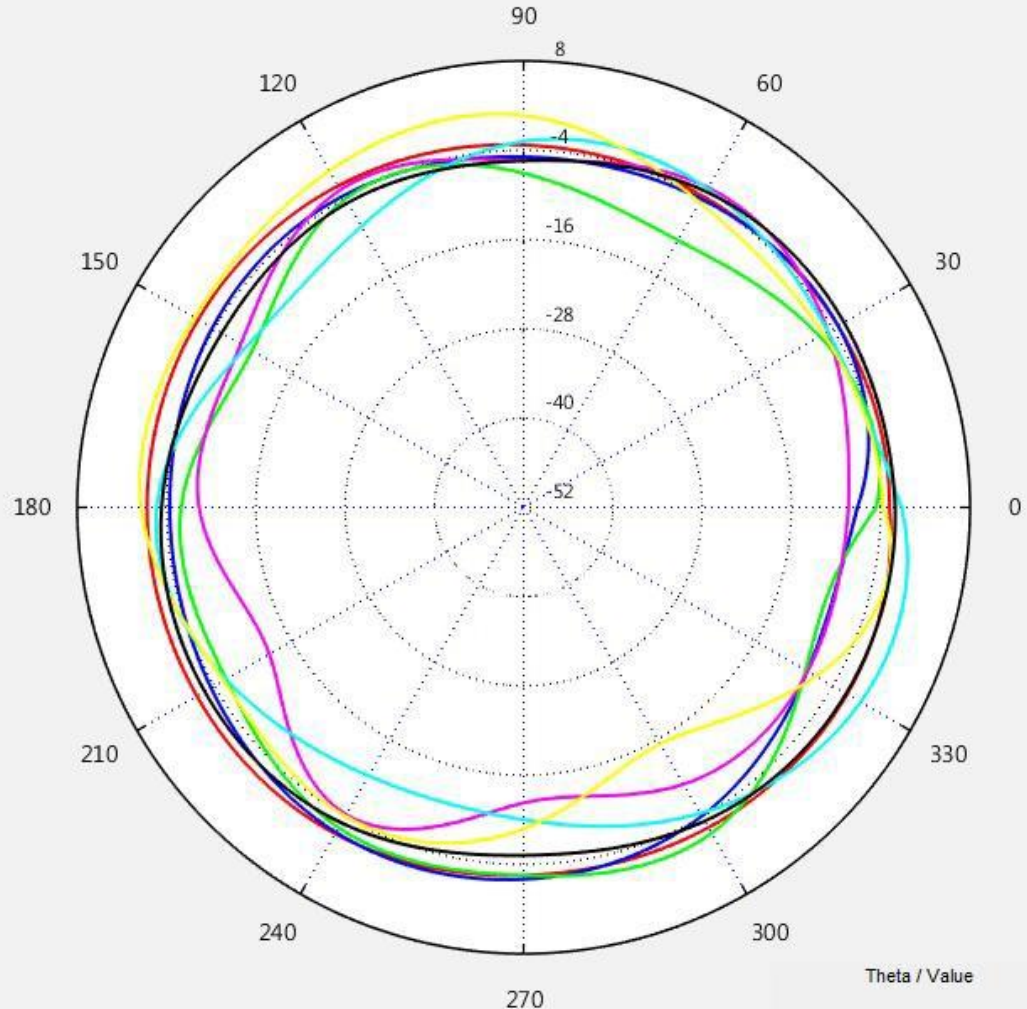

Theta / Value

Directional pattern (5.85G)

Theta

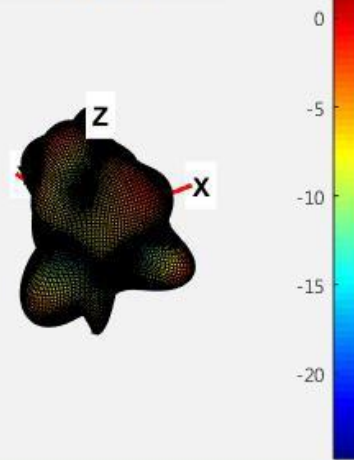

Phi

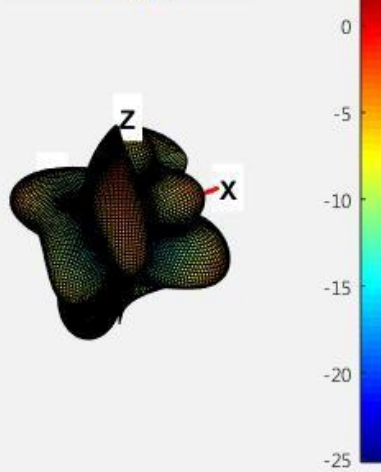

Total

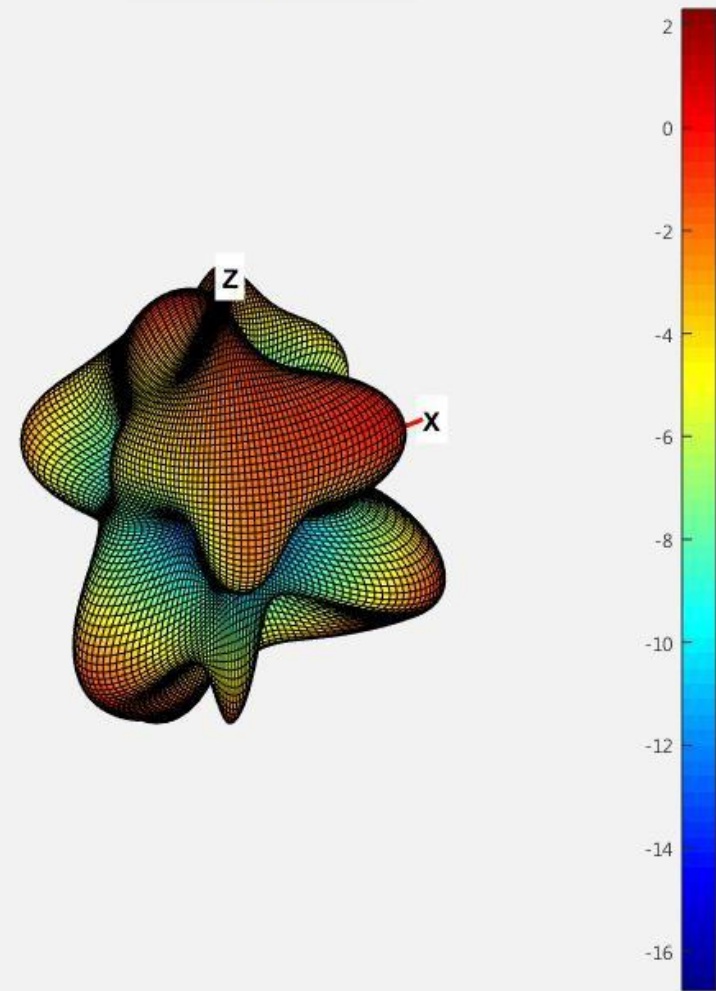



Thank you !