



FCC PART 15 SUBPART C TEST REPORT

FCC PART 15.247

Report Reference No..... : GRCTR220602007-02

FCC ID..... : 2A7EH-E2

Compiled by ( position+printed name+signature)..: Testing Engineer Jimmy Wang

Supervised by ( position+printed name+signature)..: Project Engineer Kelley Zhang

Approved by ( position+printed name+signature)..: Manager Sam Wang

Date of issue..... : Jul. 05, 2022

Testing Laboratory Name..... : Shenzhen GUOREN Certification Technology Service Co., Ltd.

Address..... : 101#, Building K & Building T, The Second Industrial Zone, Jiazitang Community, Fenghuang Street, Guangming District, Shenzhen, China

Applicant's name..... : Shenzhen Sanjiang Lechuang Technology Co., Ltd.

Address..... : Area 401B, 4th Floor, Building A7, No. 416, Xuegang North Road, Qinghu Community, Longhua Street, Longhua District, Shenzhen, Guangdong, China

Test specification..... :

Standard..... : FCC Part 15.247

Shenzhen GUOREN Certification Technology Service Co., Ltd. All rights reserved.

This publication may be reproduced in whole or in part for non-commercial purposes as long as the Shenzhen GUOREN Certification Technology Service Co., Ltd. is acknowledged as copyright owner and source of the material. Shenzhen GUOREN Certification Technology Service Co., Ltd. takes no responsibility for and will not assume liability for damages resulting from the reader's interpretation of the reproduced material due to its placement and context.

Test item description..... : Element 2 Voice-controlled Dual Dashcam

Trade Mark..... : /

Manufacturer..... : Shenzhen Sanjiang Lechuang Technology Co., Ltd.

Model/Type reference..... : E2

Listed Models ..... : E2 PRO, E2S

Modulation Type..... : CCK/DSSS/ OFDM

Operation Frequency..... : From 2412 - 2462MHz

Rating..... : DC 5.0V from car charger

Result..... : PASS

# TEST REPORT

Equipment under Test : Element 2 Voice-controlled Dual Dashcam

Model /Type : E2

Listed Models : E2 PRO, E2S

Applicant : **Shenzhen Sanjiang Lechuang Technology Co., Ltd.**

Address : Area 401B, 4th Floor, Building A7, No. 416, Xuegang North Road, Qinghu Community, Longhua Street, Longhua District, Shenzhen, Guangdong, China

Manufacturer : **Shenzhen Sanjiang Lechuang Technology Co., Ltd.**

Address : Area 401B, 4th Floor, Building A7, No. 416, Xuegang North Road, Qinghu Community, Longhua Street, Longhua District, Shenzhen, Guangdong, China

<b>Test Result:</b>	<b>PASS</b>
---------------------	-------------

The test report merely corresponds to the test sample.  
It is not permitted to copy extracts of these test result without the written permission of the test laboratory.

## Contents

<b>1 TEST STANDARDS .....</b>	<b>4</b>
<b>2 SUMMARY .....</b>	<b>5</b>
2.1 General Remarks .....	5
2.2 Product Description .....	5
2.3 Short description of the Equipment under Test (EUT) .....	5
2.4 EUT operation mode .....	6
2.5 Block Diagram of Test Setup .....	6
2.6 Related Submittal(s) / Grant (s) .....	6
2.7 Modifications .....	6
<b>3 TEST ENVIRONMENT .....</b>	<b>7</b>
3.1 Address of the test laboratory .....	7
3.2 Test Facility .....	7
3.3 Environmental conditions .....	7
3.4 Test Description .....	8
3.5 Statement of the measurement uncertainty .....	8
3.6 Equipments Used during the Test .....	9
<b>4 TEST CONDITIONS AND RESULTS .....</b>	<b>10</b>
4.1 AC Power Conducted Emission .....	10
4.2 Radiated Emission .....	11
4.3 Maximum Conducted Output Power .....	17
4.4 Power Spectral Density .....	18
4.5 6dB Bandwidth .....	21
4.6 Out-of-band Emissions .....	24
4.7 Antenna Requirement .....	31
<b>5 TEST SETUP PHOTOS OF THE EUT .....</b>	<b>32</b>
<b>6 PHOTOS OF THE EUT .....</b>	<b>32</b>

# **1 TEST STANDARDS**

The tests were performed according to following standards:

[FCC Rules Part 15.247](#): Frequency Hopping, Direct Spread Spectrum and Hybrid Systems that are in operation within the bands of 902-928 MHz, 2400-2483.5 MHz, and 5725-5850 MHz.

[ANSI C63.10-2013](#): American National Standard for Testing Unlicensed Wireless Devices

[KDB558074 D01 v05r02](#): Guidance for Compliance Measurements on Digital Transmission Systems (DTS) ,Frequency Hopping Spread Spectrum System(HFSS), and Hybrid System Devices Operating Under §15.247 of The FCC rules.

## 2 SUMMARY

### 2.1 General Remarks

Date of receipt of test sample	:	Jun. 01, 2022
Testing commenced on	:	Jun. 01, 2022
Testing concluded on	:	Jul. 05, 2022

### 2.2 Product Description

Product Name:	Element 2 Voice-controlled Dual Dashcam
Model/Type reference:	E2
Listed Models	E2 PRO, E2S(The products are identical in interior structure, electrical circuits and components, just model names and power are different.)
Power supply:	DC 5.0V From car charger
Adapter information:	Input:DC12-24V USB Output:DC 5V,2.4A Wire Output:DC 5V,2.4A
testing sample ID:	GRCTS220602007-1# (Engineer sample), GRCTS220602007-2# (Normal sample)
Firmware Version.....	V1.0
Hardware Version.....	V1.0
<b>WIFI :</b>	
Supported type:	802.11b/802.11g/802.11n(H20)
Modulation:	802.11b: DSSS 802.11g/802.11n(H20)
Operation frequency:	802.11b/802.11g/802.11n(H20): 2412MHz~2462MHz
Channel number:	802.11b/802.11g/802.11n(H20): 11
Channel separation:	5MHz
Antenna type:	FPC antenna
Antenna gain* (Supplied by the customer) :	2.39 dBi
Remark:*When the information provided by the customer was used to calculate test results, if the information provided by the customer is not accurate, shenzhen GUOREN Certification Technology Service Co., Ltd. does not assume any responsibility.	

### 2.3 Short description of the Equipment under Test (EUT)

This is a Element 2 Voice-controlled Dual Dashcam.  
For more details, refer to the user's manual of the EUT.

### 2.4 EUT operation mode

The Applicant provides communication tools software(RtlBluetoothMP) to control the EUT for staying in continuous transmitting (Duty Cycle more than 98%) for testing meet KDB558074 test requirement.

IEEE 802.11b/g/n H20: Thirteen channels are provided to the EUT.

Channel	Frequency(MHz)	Channel	Frequency(MHz)
1	2412	8	2447
2	2417	9	2452
3	2422	10	2457
4	2427	11	2462
5	2432		
6	2437		
7	2442		

### 2.5 Block Diagram of Test Setup

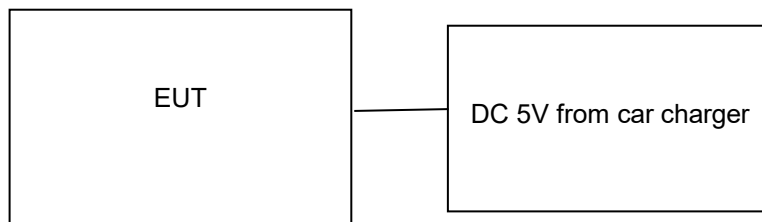

### 2.6 Related Submittal(s) / Grant (s)

This submittal(s) (test report) is intended for filing to comply with Section 15.247 of the FCC Part 15, Subpart C Rules.

### 2.7 Modifications

No modifications were implemented to meet testing criteria.

### **3 TEST ENVIRONMENT**

#### **3.1 Address of the test laboratory**

**Shenzhen GUOREN Certification Technology Service Co., Ltd.**

101#, Building K & Building T, The Second Industrial Zone, Jiazitang Community, Fenghuang Street, Guangming District, Shenzhen, China

#### **3.2 Test Facility**

The test facility is recognized, certified, or accredited by the following organizations:

**FCC-Registration No.: 920798 Designation Number: CN1304**

Shenzhen GUOREN Certification Technology Service Co., Ltd. has been listed on the US Federal Communications Commission list of test facilities recognized to perform electromagnetic emissions measurements.

**A2LA-Lab Cert. No.: 6202.01**

Shenzhen GUOREN Certification Technology Service Co., Ltd. has been listed by American Association for Laboratory Accreditation to perform electromagnetic emission measurement.

**ISED#: 27264 CAB identifier: CN0115**

Shenzhen GUOREN Certification Technology Service Co., Ltd. has been listed by Innovation, Science and Economic Development Canada to perform electromagnetic emission measurement.

**CNAS-Lab Code: L15631**

Shenzhen GUOREN Certification Technology Service Co., Ltd. has been assessed and proved to be in compliance with CNAS-CL01 Accreditation Criteria for Testing and Calibration Laboratories for the Competence of Testing and Calibration Laboratories.

The 3m-Semi anechoic test site fulfils CISPR 16-1-4 according to ANSI C63.10 and CISPR 16-1-4:2010.

#### **3.3 Environmental conditions**

During the measurement the environmental conditions were within the listed ranges:

Normal Temperature:	15-35 °C
Relative Humidity	30-60 %
Air Pressure	950-1050mbar

### 3.4 Test Description

FCC PART 15.247		
FCC Part 15.207	AC Power Conducted Emission	N/A
FCC Part 15.247(a)(2)	6dB Bandwidth	PASS
FCC Part 15.247(d)	Spurious RF Conducted Emission	PASS
FCC Part 15.247(b)	Maximum Conducted Output Power	PASS
FCC Part 15.247(e)	Power Spectral Density	PASS
FCC Part 15.109/ 15.205/ 15.209	Radiated Emissions	PASS
FCC Part 15.247(d)	Band Edge	PASS
FCC Part 15.203/15.247 (b)	Antenna Requirement	PASS

#### Data Rate Used:

Preliminary tests were performed in different data rate to find the worst radiated emission. The data rate shown in the table below is the worst-case rate with respect to the specific test item. Investigation has been done on all the possible configurations for searching the worst cases. The following table is a list of the test modes shown in this test report.

Test Items	Mode	Data Rate	Channel
Maximum Peak Conducted Output Power Power Spectral Density 6dB Bandwidth Spurious RF conducted emission Radiated Emission 9KHz~1GHz& Radiated Emission 1GHz~10th Harmonic	11b/DSSS	1 Mbps	1/6/11
	11g/OFDM	6 Mbps	1/6/11
	11n(20MHz)/OFDM	6.5Mbps	1/6/11
Band Edge	11b/DSSS	1 Mbps	1/11
	11g/OFDM	6 Mbps	1/11
	11n(20MHz)/OFDM	6.5Mbps	1/11

### 3.5 Statement of the measurement uncertainty

The data and results referenced in this document are true and accurate. The reader is cautioned that there may be errors within the calibration limits of the equipment and facilities. The measurement uncertainty was calculated for all measurements listed in this test report acc. to TR-100028-01" Electromagnetic compatibility and Radio spectrum Matters (ERM);Uncertainties in the measurement of mobile radio equipment characteristics; Part 1" and TR-100028-02 "Electromagnetic compatibility and Radio spectrum Matters (ERM);Uncertainties in the measurement of mobile radio equipment characteristics; Part 2 " and is documented in the Shenzhen GUOREN Certification Technology Service Co., Ltd.quality system acc. to DIN EN ISO/IEC 17025. Furthermore, component and process variability of devices similar to that tested may result in additional deviation. The manufacturer has the sole responsibility of continued compliance of the device.

Hereafter the best measurement capability for Shenzhen GUOREN Certification Technology Service Co., Ltd.:

Test	Range	Measurement Uncertainty	Notes
Radiated Emission	30~1000MHz	4.06 dB	(1)
Radiated Emission	1~18GHz	5.14 dB	(1)
Radiated Emission	18-40GHz	5.38 dB	(1)
Conducted Disturbance	0.15~30MHz	2.14 dB	(1)

- (1) This uncertainty represents an expanded uncertainty expressed at approximately the 95% confidence level using a coverage factor of k=2.



### 3.6 Equipments Used during the Test

Test Equipment	Manufacturer	Model No.	Equipment No.	Calibration Date	Calibration Due Date
LISN	R&S	ENV216	GRCTEE009	2021/10/30	2022/10/29
LISN	R&S	ENV216	GRCTEE010	2021/10/30	2022/10/29
EMI Test Receiver	R&S	ESPI	GRCTEE017	2021/10/30	2022/10/29
EMI Test Receiver	R&S	ESCI	GRCTEE008	2021/10/30	2022/10/29
Spectrum Analyzer	Agilent	N9020A	GRCTEE002	2021/10/30	2022/10/29
Spectrum Analyzer	R&S	FSP	GRCTEE003	2021/10/20	2022/10/19
Vector Signal generator	Agilent	N5181A	GRCTEE007	2021/10/30	2022/10/29
Analog Signal Generator	R&S	SML03	GRCTEE006	2021/10/30	2022/10/29
Climate Chamber	QIYA	LCD-9530	GRCTES016	2021/10/30	2022/10/29
Ultra-Broadband Antenna	Schwarzbeck	VULB9163	GRCTEE018	2020/10/25	2023/10/24
Horn Antenna	Schwarzbeck	BBHA 9120D	GRCTEE019	2020/10/25	2023/10/24
Loop Antenna	Zhinan	ZN30900C	GRCTEE020	2020/10/25	2023/10/24
Horn Antenna	Beijing Hangwei Dayang	OBH100400	GRCTEE049	2021/1/18	2024/1/17
Amplifier	Schwarzbeck	BBV 9745	GRCTEE021	2021/10/30	2022/10/29
Amplifier	Taiwan chengyi	EMC051845B	GRCTEE022	2021/10/30	2022/10/29
Temperature/Humidity Meter	Huaguan	HG-308	GRCTES037	2021/10/30	2022/10/29
Directional coupler	NARDA	4226-10	GRCTEE004	2021/10/30	2022/10/29
High-Pass Filter	XingBo	XBLBQ-GTA18	GRCTEE053	2021/10/30	2022/10/29
High-Pass Filter	XingBo	XBLBQ-GTA27	GRCTEE054	2021/10/30	2022/10/29
Automated filter bank	Tonscend	JS0806-F	GRCTEE055	2021/10/30	2022/10/29
Power Sensor	Agilent	U2021XA	GRCTEE070	2021/10/30	2022/10/29
EMI Test Software	ROHDE & SCHWARZ	ESK1-V1.71	GRCTEE060	N/A	N/A
EMI Test Software	Fera	EZ-EMC	GRCTEE061	N/A	N/A

## 4 TEST CONDITIONS AND RESULTS

### 4.1 AC Power Conducted Emission

#### TEST CONFIGURATION

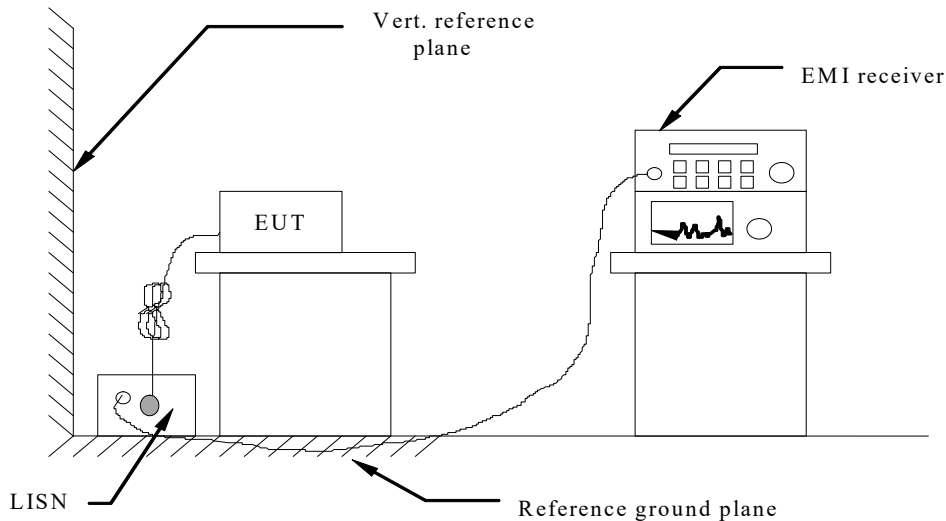

#### TEST PROCEDURE

- 1 The equipment was set up as per the test configuration to simulate typical actual usage per the user's manual. The EUT is a tabletop system, a wooden table with a height of 0.8 meters is used and is placed on the ground plane as per ANSI C63.10-2013.
- 2 Support equipment, if needed, was placed as per ANSI C63.10-2013
- 3 All I/O cables were positioned to simulate typical actual usage as per ANSI C63.10-2013
- 4 The EUT received power from adapter, the adapter received AC120V/60Hz and AC 240V/60Hz power through a Line Impedance Stabilization Network (LISN) which supplied power source and was grounded to the ground plane.
- 5 All support equipments received AC power from a second LISN, if any.
- 6 The EUT test program was started. Emissions were measured on each current carrying line of the EUT using a spectrum Analyzer / Receiver connected to the LISN powering the EUT. The LISN has two monitoring points: Line 1 (Hot Side) and Line 2 (Neutral Side). Two scans were taken: one with Line 1 connected to Analyzer / Receiver and Line 2 connected to a 50 ohm load; the second scan had Line 1 connected to a 50 ohm load and Line 2 connected to the Analyzer / Receiver.
- 7 Analyzer / Receiver scanned from 150 KHz to 30MHz for emissions in each of the test modes.
- 8 During the above scans, the emissions were maximized by cable manipulation.

#### AC Power Conducted Emission Limit

For intentional device, according to § 15.207(a) and RSS-Gen Issue 5 AC Power Conducted Emission Limits is as following:

Frequency range (MHz)	Limit (dBuV)	
	Quasi-peak	Average
0.15-0.5	66 to 56*	56 to 46*
0.5-5	56	46
5-30	60	50

\* Decreases with the logarithm of the frequency.

#### TEST RESULTS

The EUT is powered by car charger, so this test item is not applicable for the EUT.

### 4.2 Radiated Emission

#### TEST CONFIGURATION

Frequency range 9 KHz – 30MHz

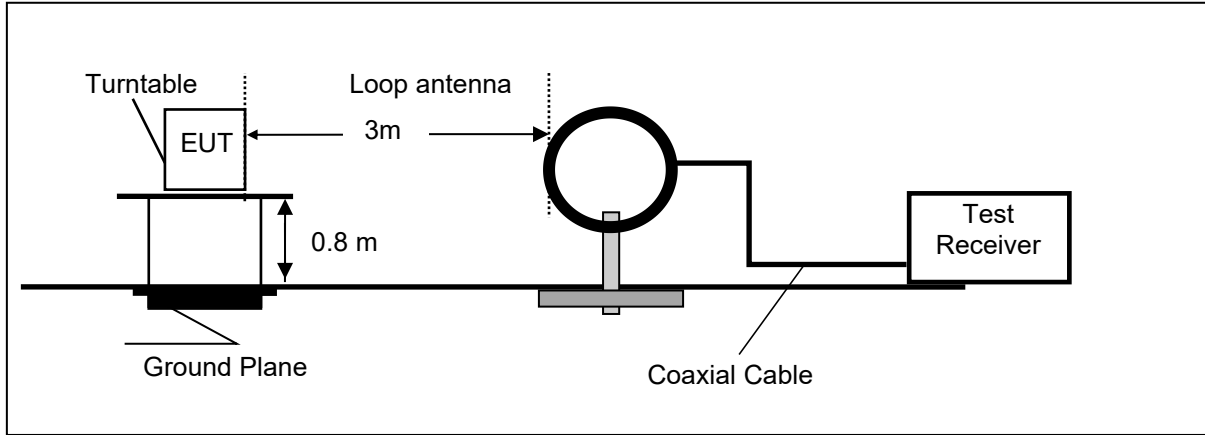

Frequency range 30MHz – 1000MHz

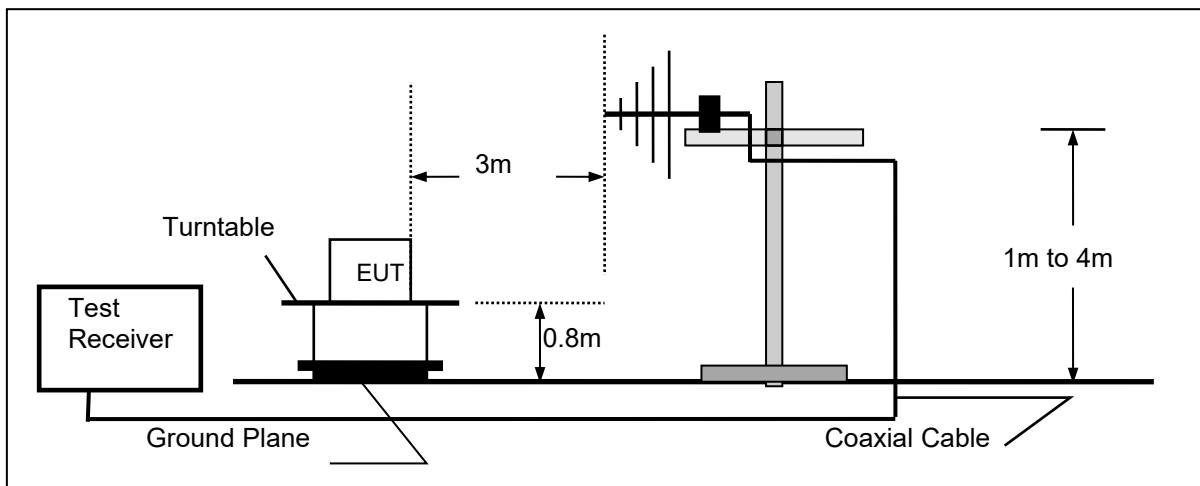

Frequency range above 1GHz-25GHz

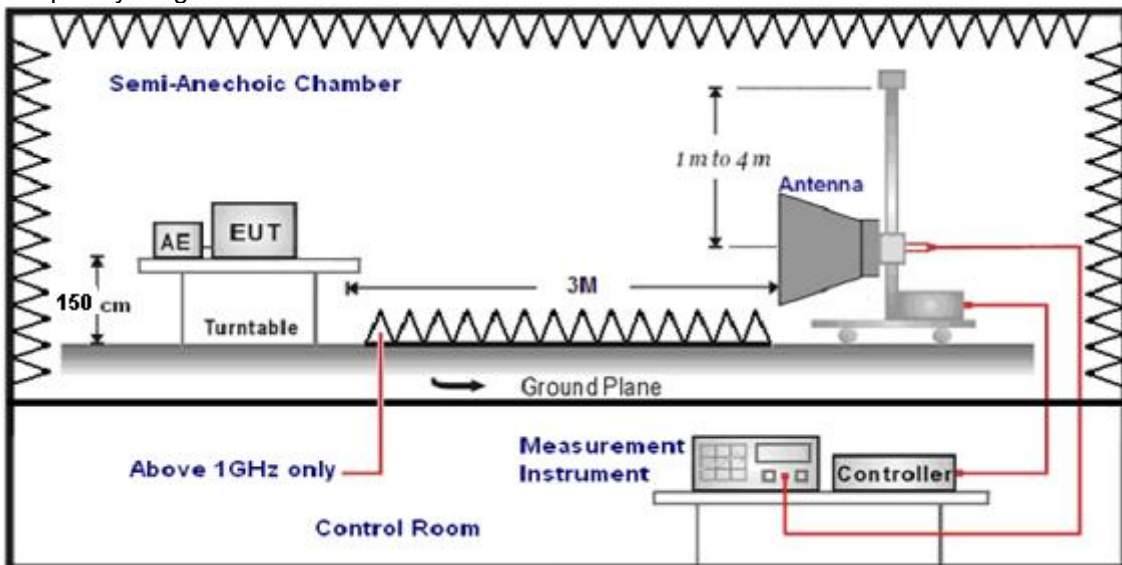

**TEST PROCEDURE**

1. The EUT was placed on a turn table which is 0.8m above ground plane when testing frequency range 9 KHz –1GHz, the EUT was placed on a turn table which is 1.5m above ground plane when testing frequency range 1GHz – 25GHz.
2. Maximum procedure was performed by raising the receiving antenna from 1m to 4m and rotating the turn table from 0° to 360° to acquire the highest emissions from EUT.
3. And also, each emission was to be maximized by changing the polarization of receiving antenna both horizontal and vertical.
4. Repeat above procedures until all frequency measurements have been completed.
5. Radiated emission test frequency band from 9KHz to 25GHz.
6. The distance between test antenna and EUT as following table states:

Test Frequency range	Test Antenna Type	Test Distance
9KHz-30MHz	Active Loop Antenna	3
30MHz-1GHz	Ultra-Broadband Antenna	3
1GHz-18GHz	Double Ridged Horn Antenna	3
18GHz-25GHz	Horn Antenna	1

7. Setting test receiver/spectrum as following table states:

Test Frequency range	Test Receiver/Spectrum Setting	Detector
9KHz-150KHz	RBW=200Hz/VBW=3KHz, Sweep time=Auto	QP
150KHz-30MHz	RBW=9KHz/VBW=100KHz, Sweep time=Auto	QP
30MHz-1GHz	RBW=120KHz/VBW=1000KHz, Sweep time=Auto	QP
1GHz-40GHz	Peak Value: RBW=1MHz/VBW=3MHz, Sweep time=Auto Average Value: RBW=1MHz/VBW=10Hz, Sweep time=Auto	Peak

**Field Strength Calculation**

The field strength is calculated by adding the Antenna Factor and Cable Factor and subtracting the Amplifier Gain and Duty Cycle Correction Factor(if any) from the measured reading. The basic equation with a sample calculation is as follows:

**FS = RA + AF + CL - AG**

Where FS = Field Strength	CL = Cable Attenuation Factor (Cable Loss)
RA = Reading Amplitude	AG = Amplifier Gain
AF = Antenna Factor	

Transd=AF +CL-AG

**RADIATION LIMIT**

For intentional device, according to § 15.209(a), the general requirement of field strength of radiated emission from intentional radiators at a distance of 3 meters shall not exceed the following table. According to § 15.247(d), in any 100kHz bandwidth outside the frequency band in which the EUT is operating, the radio frequency power that is produced by the intentional radiator shall be at least 20dB below that in the 100kHz bandwidth within the band that contains the highest level of desired power.

The pre-test have done for the EUT in three axes and found the worst emission at position shown in test setup photos.

Frequency (MHz)	Distance (Meters)	Radiated (dBµV/m)	Radiated (µV/m)
0.009-0.49	3	20log(2400/F(KHz))+40log(300/3)	2400/F(KHz)
0.49-1.705	3	20log(24000/F(KHz))+ 40log(30/3)	24000/F(KHz)
1.705-30	3	20log(30)+ 40log(30/3)	30
30-88	3	40.0	100
88-216	3	43.5	150
216-960	3	46.0	200
Above 960	3	54.0	500

**TEST RESULTS**

Remark:

1. This test was performed with EUT in X, Y, Z position and the worse case was found when EUT in X position.
2. All three channels (lowest/middle/highest) of each mode were measured below 1GHz and recorded worst case at 802.11b low channel.
3. Radiated emission test from 9 KHz to 10th harmonic of fundamental was verified, and no emission found except system noise floor in 9 KHz to 30MHz and not recorded in this report.

**For 30MHz-1GHz**

Horizontal

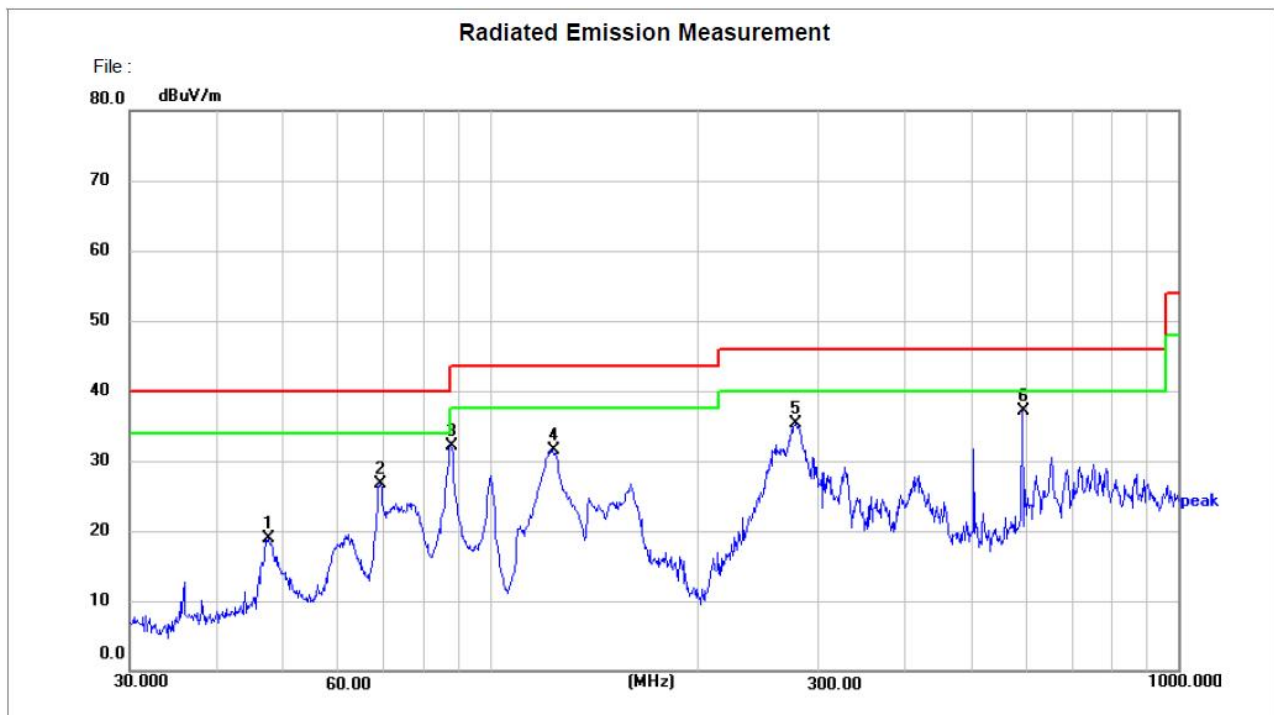

Site LAB  
 Limit: FCC Part15 RE-Class B\_30-1000MHz  
 EUT:  
 M/N: E2  
 Mode:  
 Note:

Polarization: *Horizontal*  
 Power: DC12V  
 Distance: 3m

Temperature: 24.5(C)  
 Humidity: 52 %

No.	Frequency (MHz)	Reading (dBuV)	Factor (dB/m)	Level (dBuV/m)	Limit (dBuV/m)	Margin (dB)	Detector	Height (cm)	Azimuth (deg.)	P/F	Remark
1	47.6586	36.72	-17.81	18.91	40.00	-21.09	peak	100	1	P	
2	69.3568	47.43	-20.78	26.65	40.00	-13.35	peak	100	290	P	
3 *	87.7248	53.25	-21.17	32.08	40.00	-7.92	peak	200	355	P	
4	123.2655	52.67	-21.23	31.44	43.50	-12.06	peak	200	9	P	
5	278.0668	52.92	-17.55	35.37	46.00	-10.63	peak	100	60	P	
6	593.0497	48.16	-11.07	37.09	46.00	-8.91	peak	100	313	P	

Note:1).Level (dBuV/m)= Reading (dBuV)+ Factor (dB/m)

2). Factor(dB/m)=Antenna Factor (dB/m) + Cable loss (dB) - Pre Amplifier gain (dB)

3). Margin(dB) = Limit (dBuV/m) - Level (dBuV/m)

Vertical

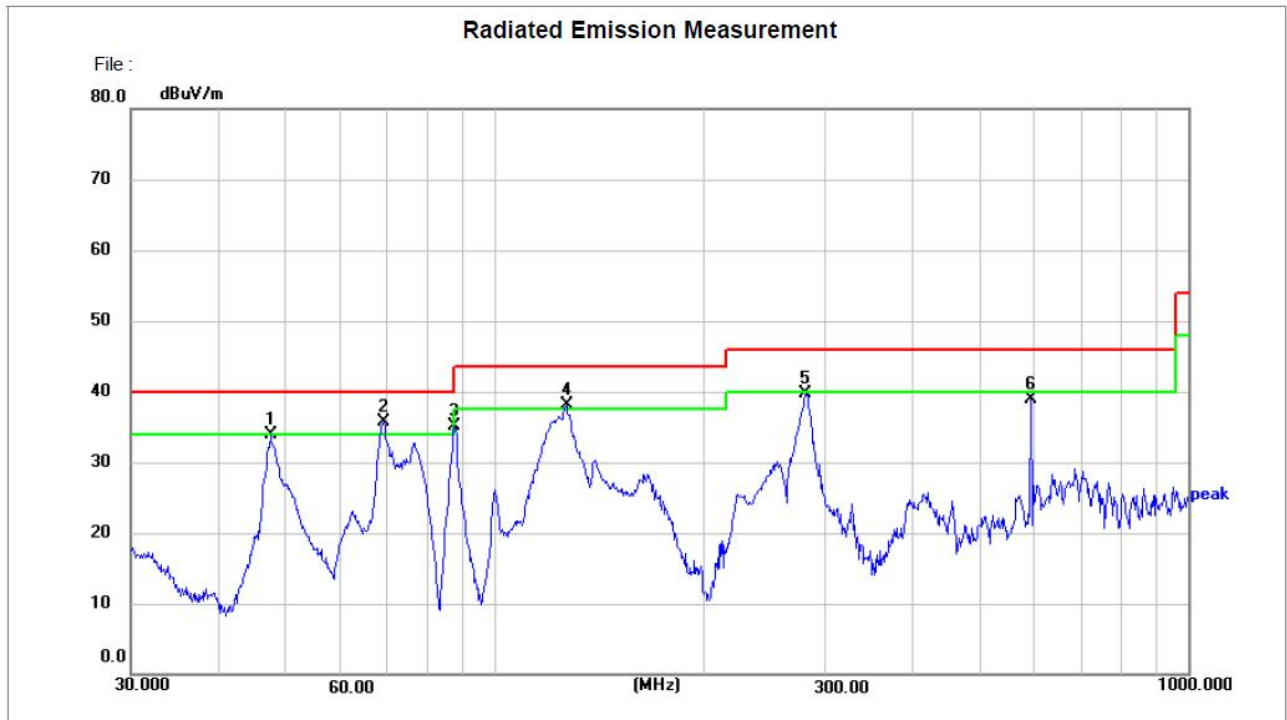

Site LAB  
 Limit: FCC Part15 RE-Class B\_30-1000MHz  
 EUT:  
 M/N: E2  
 Mode:  
 Note:

Polarization: *Vertical*  
 Power: DC12V  
 Distance: 3m

Temperature: 24.5(C)  
 Humidity: 52 %

No.	Frequency (MHz)	Reading (dBuV)	Factor (dB/m)	Level (dBuV/m)	Limit (dBuV/m)	Margin (dB)	Detector	Height (cm)	Azimuth (deg.)	P/F	Remark
1	47.6584	51.65	-17.81	33.84	40.00	-6.16	peak	100	298	P	
2 *	69.3568	56.40	-20.78	35.62	40.00	-4.38	peak	100	70	P	
3 !	87.7246	56.20	-21.17	35.03	40.00	-4.97	peak	100	90	P	
4 !	127.2176	60.30	-22.23	38.07	43.50	-5.43	peak	100	197	P	
5	281.0074	57.24	-17.46	39.78	46.00	-6.22	peak	100	137	P	
6	593.0496	49.90	-11.07	38.83	46.00	-7.17	peak	100	358	P	

Note:1).Level (dBuV/m)= Reading (dBuV)+ Factor (dB/m)

2). Factor(dB/m)=Antenna Factor (dB/m) + Cable loss (dB) - Pre Amplifier gain (dB)

3). Margin(dB) = Limit (dBuV/m) - Level (dBuV/m)

**For 1GHz to 25GHz**

Note: 802.11b/802.11g/802.11n (H20) Mode all have been tested, only worse case 802.11b mode is reported.

(above 1GHz)

Frequency(MHz):			2412		Polarity:		HORIZONTAL		
Frequency (MHz)	Emission Level (dBuV/m)		Limit (dBuV/m)	Margin (dB)	Raw Value (dBuV)	Antenna Factor (dB/m)	Cable Factor (dB)	Pre-amplifier (dB)	Correction Factor (dB/m)
4824.00	58.57	PK	74	15.43	79.80	28.37	5.1	54.7	-21.23
4824.00	46.83	AV	54	7.17	68.06	28.37	5.1	54.7	-21.23
7236.00	56.74	PK	74	17.26	71.23	34.10	6.42	55.01	-14.49
7236.00	43.89	AV	54	10.11	58.38	34.10	6.42	55.01	-14.49

Frequency(MHz):			2412		Polarity:		VERTICAL		
Frequency (MHz)	Emission Level (dBuV/m)		Limit (dBuV/m)	Margin (dB)	Raw Value (dBuV)	Antenna Factor (dB/m)	Cable Factor (dB)	Pre-amplifier (dB)	Correction Factor (dB/m)
4824.00	57.64	PK	74	16.36	78.87	28.37	5.10	54.7	-21.23
4824.00	46.28	AV	54	7.72	67.51	28.37	5.10	54.7	-21.23
7236.00	56.43	PK	74	17.57	70.92	34.10	6.42	55.01	-14.49
7236.00	43.75	AV	54	10.25	58.24	34.10	6.42	55.01	-14.49

Frequency(MHz):			2437		Polarity:		HORIZONTAL		
Frequency (MHz)	Emission Level (dBuV/m)		Limit (dBuV/m)	Margin (dB)	Raw Value (dBuV)	Antenna Factor (dB/m)	Cable Factor (dB)	Pre-amplifier (dB)	Correction Factor (dB/m)
4874.00	58.05	PK	74	15.95	78.32	28.76	5.35	54.38	-20.27
4874.00	46.17	AV	54	7.83	66.44	28.76	5.35	54.38	-20.27
7311.00	56.82	PK	74	17.18	70.45	34.40	6.83	54.86	-13.63
7311.00	43.76	AV	54	10.24	57.39	34.40	6.83	54.86	-13.63

Frequency(MHz):			2437		Polarity:		VERTICAL		
Frequency (MHz)	Emission Level (dBuV/m)		Limit (dBuV/m)	Margin (dB)	Raw Value (dBuV)	Antenna Factor (dB/m)	Cable Factor (dB)	Pre-amplifier (dB)	Correction Factor (dB/m)
4874.00	58.61	PK	74	15.39	78.88	28.76	5.35	54.38	-20.27
4874.00	46.49	AV	54	7.51	66.76	28.76	5.35	54.38	-20.27
7311.00	55.38	PK	74	18.62	69.01	34.40	6.83	54.86	-13.63
7311.00	42.76	AV	54	11.24	56.39	34.40	6.83	54.86	-13.63

Frequency(MHz):			2462		Polarity:		HORIZONTAL		
Frequency (MHz)	Emission Level (dBuV/m)		Limit (dBuV/m)	Margin (dB)	Raw Value (dBuV)	Antenna Factor (dB/m)	Cable Factor (dB)	Pre-amplifier (dB)	Correction Factor (dB/m)
4924.00	58.52	PK	74	15.48	77.97	29.54	5.66	54.65	-19.45
4924.00	46.57	AV	54	7.43	66.02	29.54	5.66	54.65	-19.45
7386.00	57.16	PK	74	16.84	70.30	34.51	7.25	54.9	-13.14
7386.00	44.54	PK	54	9.46	57.68	34.51	7.25	54.9	-13.14

Frequency(MHz):			2462		Polarity:		VERTICAL		
Frequency (MHz)	Emission Level (dBuV/m)		Limit (dBuV/m)	Margin (dB)	Raw Value (dBuV)	Antenna Factor (dB/m)	Cable Factor (dB)	Pre-amplifier (dB)	Correction Factor (dB/m)
4924.00	58.13	PK	74	15.87	77.58	29.54	5.66	54.65	-19.45
4924.00	45.81	AV	54	8.19	65.26	29.54	5.66	54.65	-19.45
7386.00	56.37	PK	74	17.63	69.51	34.51	7.25	54.9	-13.14
7386.00	43.58	PK	54	10.42	56.72	34.51	7.25	54.9	-13.14

- 1) Emission level (dBuV/m) = Meter Reading+ antenna Factor+ cable loss- preamp factor.
- 2) Margin value = Limits-Emission level.
- 3) -- Mean the PK detector measured value is below average limit.
- 4) The other emission levels were very low against the limit.
- 5) RBW1MHz VBW3MHz Peak detector is for PK value; RBW 1MHz VBW10Hz Peak detector is for AV value.

**Results of Band Edges Test (Radiated)**

Note: 802.11b/802.11g/802.11n (H20) Mode all have been tested, only worse case 802.11b mode is reported.

Frequency(MHz):			2412		Polarity:		HORIZONTAL		
Frequency (MHz)	Emission Level (dBuV/m)		Limit (dBuV/m)	Margin (dB)	Raw Value (dBuV)	Antenna Factor (dB/m)	Cable Factor (dB)	Pre-amplifier (dB)	Correction Factor (dB/m)
2390.00	55.04	PK	74	18.96	79.76	25.72	4.32	54.76	-24.72
2390.00	43.29	AV	54	10.71	68.01	25.72	4.32	54.76	-24.72
Frequency(MHz):			2412		Polarity:		VERTICAL		
Frequency (MHz)	Emission Level (dBuV/m)		Limit (dBuV/m)	Margin (dB)	Raw Value (dBuV)	Antenna Factor (dB/m)	Cable Factor (dB)	Pre-amplifier (dB)	Correction Factor (dB/m)
2390.00	54.86	PK	74	19.14	79.58	25.72	4.32	54.76	-24.72
2390.00	42.46	AV	54	11.54	67.18	25.72	4.32	54.76	-24.72
Frequency(MHz):			2462		Polarity:		HORIZONTAL		
Frequency (MHz)	Emission Level (dBuV/m)		Limit (dBuV/m)	Margin (dB)	Raw Value (dBuV)	Antenna Factor (dB/m)	Cable Factor (dB)	Pre-amplifier (dB)	Correction Factor (dB/m)
2483.50	54.93	PK	74	19.07	79.50	25.78	4.48	54.83	-24.57
2483.50	43.14	AV	54	10.86	67.71	25.78	4.48	54.83	-24.57
Frequency(MHz):			2462		Polarity:		VERTICAL		
Frequency (MHz)	Emission Level (dBuV/m)		Limit (dBuV/m)	Margin (dB)	Raw Value (dBuV)	Antenna Factor (dB/m)	Cable Factor (dB)	Pre-amplifier (dB)	Correction Factor (dB/m)
2483.50	54.24	PK	74	19.76	78.81	25.78	4.48	54.83	-24.57
2483.50	41.86	AV	54	12.14	66.43	25.78	4.48	54.83	-24.57

Note:

- 1) Emission level (dBuV/m) = Meter Reading+ antenna Factor+ cable loss- preamp factor.
- 2) Margin value = Limits-Emission level.
- 3) -- Mean the PK detector measured value is below average limit.
- 4) The other emission levels were very low against the limit.
- 5) RBW1MHz VBW3MHz Peak detector is for PK value; RBW 1MHz VBW10Hz Peak detector is for AV value.



### 4.3 Maximum Conducted Output Power

#### Limit

The Maximum Peak Output Power Measurement is 30dBm.

#### Test Procedure

Remove the antenna from the EUT and then connect a low loss RF cable from the antenna port to the power sensor.

#### Test Configuration

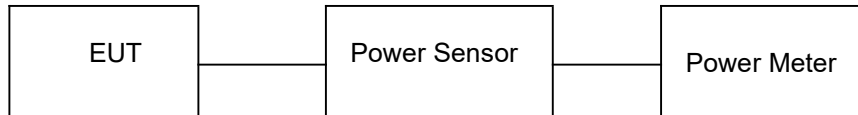

#### Test Results

Type	Channel	Output power PK (dBm)	Limit (dBm)	Result
802.11b	01	14.41	30.00	Pass
	06	14.82		
	11	14.79		
802.11g	01	14.72	30.00	Pass
	06	14.59		
	11	14.78		
802.11n(HT20)	01	13.93	30.00	Pass
	06	13.84		
	11	13.54		

Note:

- 1) Measured output power at difference data rate for each mode and recorded worst case for each mode.
- 2) Test results including cable loss.
- 3) Worst case data at 1Mbps at IEEE 802.11b; 6Mbps at IEEE 802.11g; 6.5Mbps at IEEE 802.11n HT20;

### 4.4 Power Spectral Density

**Limit**

For digitally modulated systems, the power spectral density conducted from the intentional radiator to the antenna shall not be greater than 8 dBm in any 3 kHz band during any time interval of continuous transmission.

**Test Procedure**

1. Use this procedure when the maximum peak conducted output power in the fundamental emission is used to demonstrate compliance.
2. Set the RBW  $\geq$  3 kHz.
3. Set the VBW  $\geq$  3 $\times$  RBW.
4. Set the span to 1.5 times the DTS channel bandwidth.
5. Detector = peak.
6. Sweep time = auto couple.
7. Trace mode = max hold.
8. Allow trace to fully stabilize.
9. Use the peak marker function to determine the maximum power level.
10. If measured value exceeds limit, reduce RBW (no less than 3 kHz) and repeat.
11. The resulting peak PSD level must be 8dBm.

**Test Configuration**



**Test Results**

Type	Channel	Power Spectral Density (dBm/3KHz)	Limit (dBm/3KHz)	Result
802.11b	01	-14.428	8.00	Pass
	06	-13.812		
	11	-15.076		
802.11g	01	-14.856	8.00	Pass
	06	-17.231		
	11	-16.900		
802.11n(HT20)	01	-18.494	8.00	Pass
	06	-18.719		
	11	-17.645		

Note:

- 1) Measured peak power spectrum density at difference data rate for each mode and recorded worst case for each mode.
- 2) Test results including cable loss;
- 3) Worst case data at 1Mbps at IEEE 802.11b; 6Mbps at IEEE 802.11g; 6.5Mbps at IEEE 802.11n HT20;

Please refer to following plots;

802.11b



802.11g



CH01



CH01

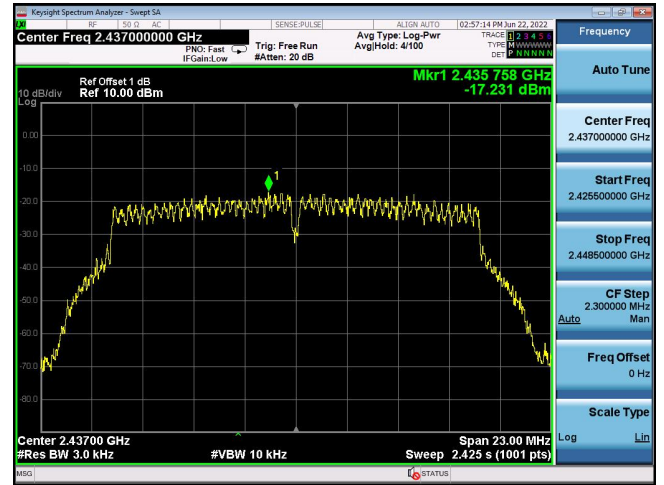

CH06



CH06



CH11

CH11

802.11n(HT20)

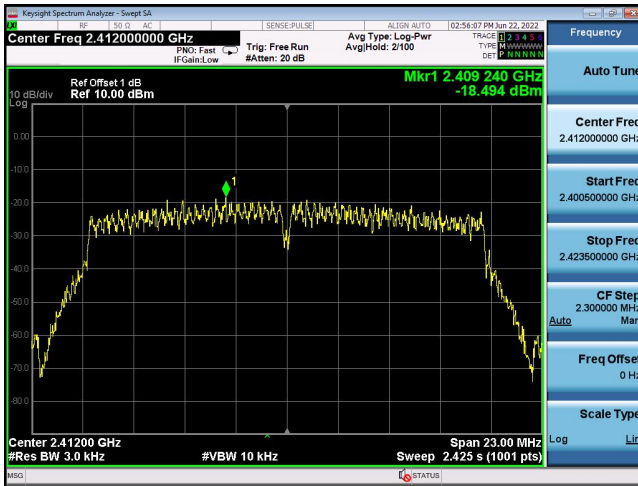

CH01

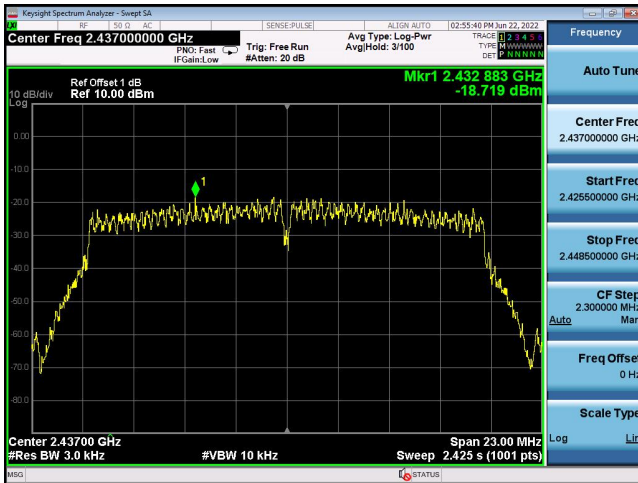

CH06

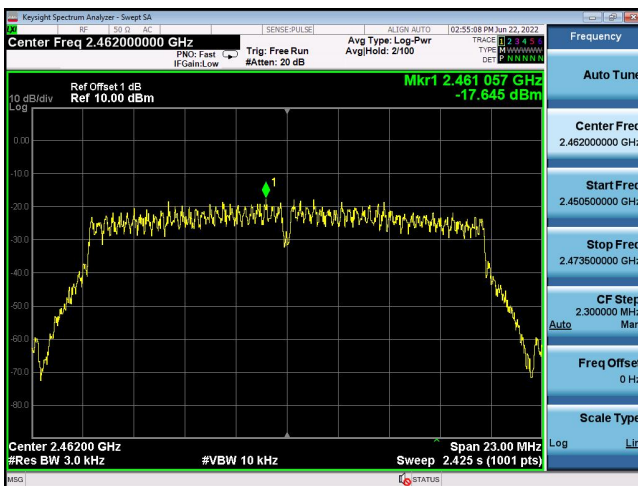

CH11

### 4.5 6dB Bandwidth

**Limit**

For digital modulation systems, the minimum 6 dB bandwidth shall be at least 500 kHz

**Test Procedure**

The transmitter output was connected to the spectrum analyzer through an attenuator. The bandwidth of the fundamental frequency was measured by spectrum analyzer with 100 KHz RBW and 300 KHz VBW. The 6dB bandwidth is defined as the total spectrum the power of which is higher than peak power minus 6dB.

**Test Configuration**



**Test Results**

Type	Channel	6dB Bandwidth (MHz)	Limit (KHz)	Result
802.11b	01	9.068	≥500	Pass
	06	9.064		
	11	9.059		
802.11g	01	15.16	≥500	Pass
	06	15.16		
	11	16.30		
802.11n(HT20)	01	15.16	≥500	Pass
	06	15.16		
	11	15.16		

Note:

- 1) Measured peak power spectrum density at difference data rate for each mode and recorded worst case for each mode.
- 2) Test results including cable loss;
- 3) Worst case data at 1Mbps at IEEE 802.11b; 6Mbps at IEEE 802.11g; 6.5Mbps at IEEE 802.11n HT20;

Please refer to following plots;

802.11b

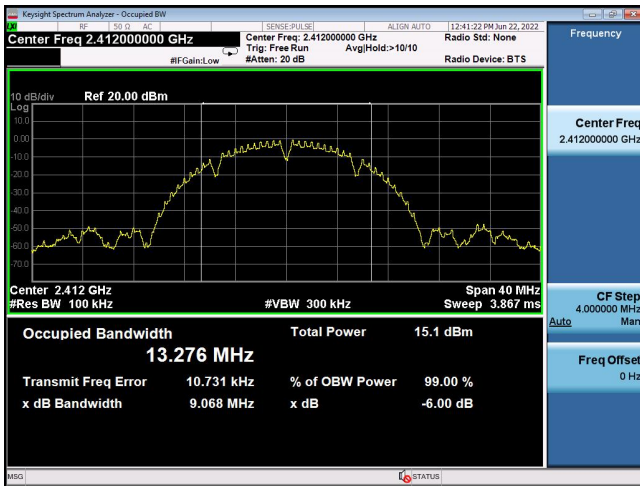

802.11g

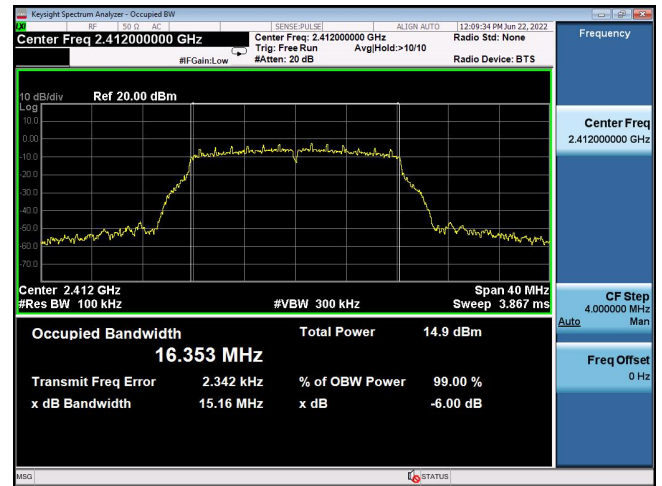

CH01

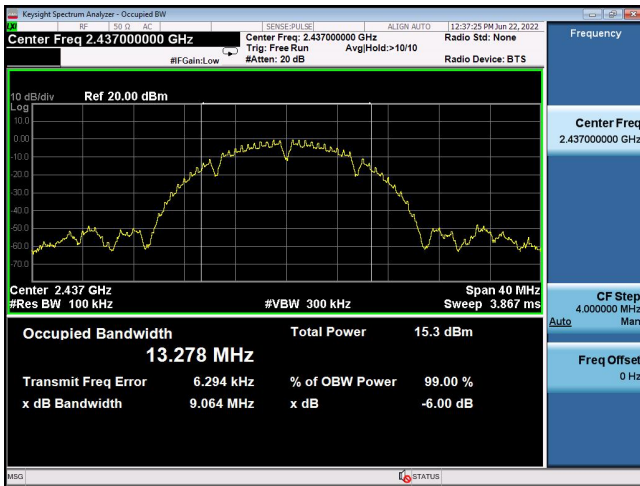

CH01

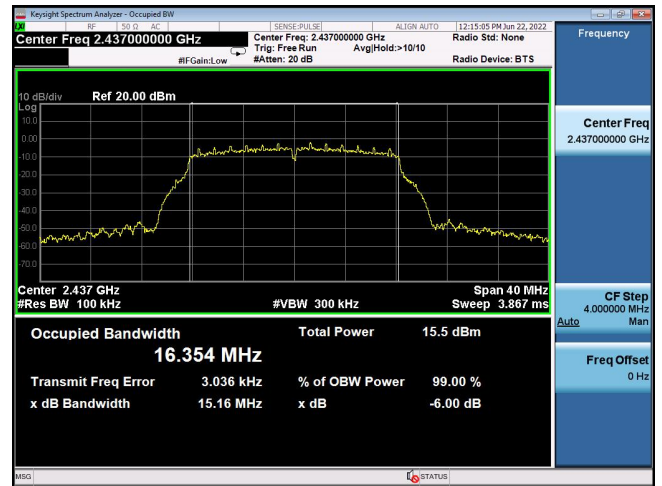

CH06

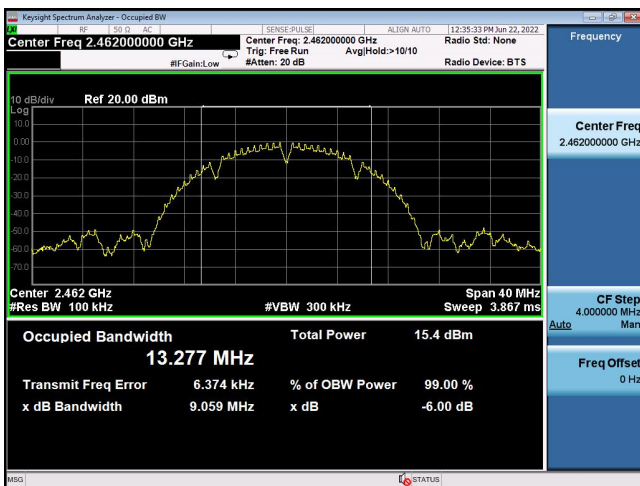

CH06

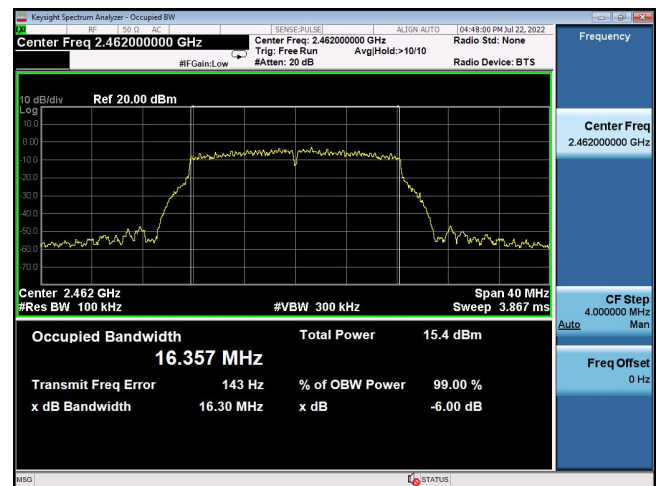

CH11



CH11



802.11n(HT20)

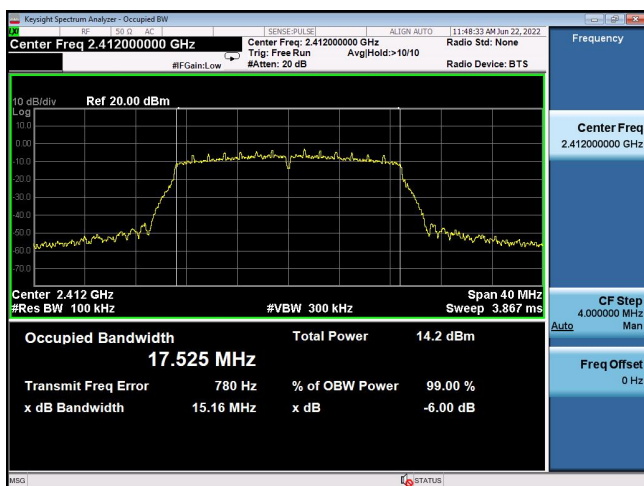

CH01

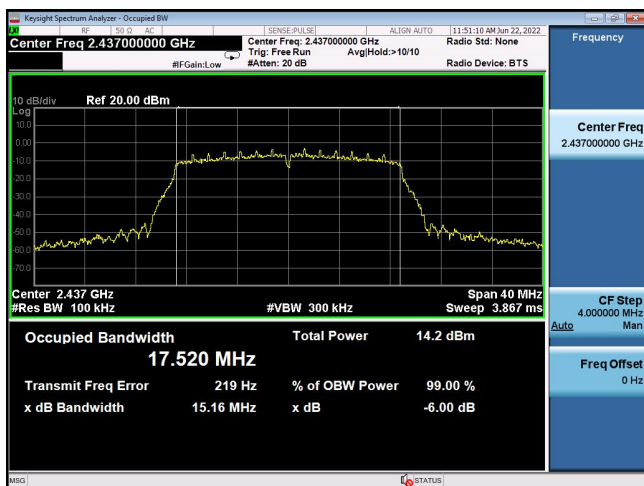

CH06

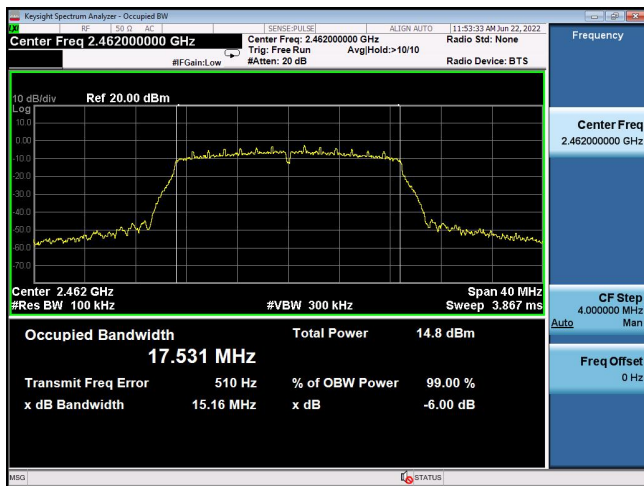

CH11

## 4.6 Out-of-band Emissions

### Limit

In any 100 kHz bandwidth outside the frequency band in which the spread spectrum or digitally modulated intentional radiator is operating, the radio frequency power that is produced by the intentional radiator shall be at least 20 dB below that in the 100 kHz bandwidth within the band that contains the highest level of the desired power, based on either an RF conducted or a radiated measurement, provided the transmitter demonstrates compliance with the peak conducted power limits. If the transmitter complies with the conducted power limits based on the use of RMS averaging over a time interval, as permitted under paragraph (b)(3) of this section, the attenuation required under this paragraph shall be 30 dB instead of 20 dB. Attenuation below the general limits specified in §15.209(a) is not required.

### Test Procedure

Connect the transmitter output to spectrum analyzer using a low loss RF cable, and set the spectrum analyzer to RBW=100 kHz, VBW= 300 kHz, peak detector, and max hold. Measurements utilizing these settings are made of the in-band reference level, bandedge and out-of-band emissions.

### Test Configuration



### Test Results

Remark: The measurement frequency range is from 30MHz to the 10th harmonic of the fundamental frequency. The lowest, middle and highest channels are tested to verify the spurious emissions and bandedge measurement data. And record the worst data in the report.

Test plot as follows:



802.11b



CH01



CH06

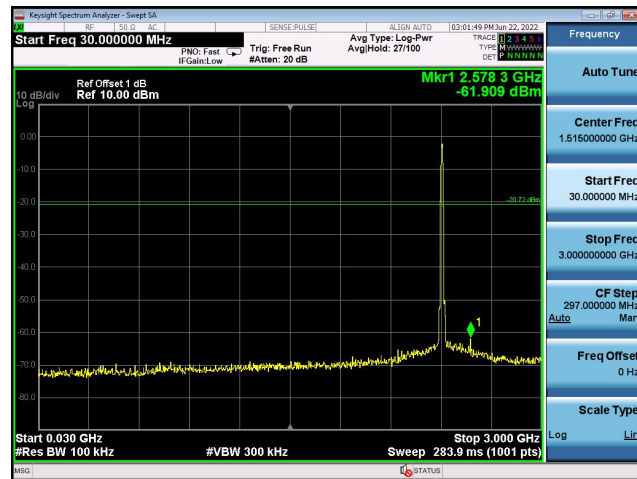

30MHz-3GHz

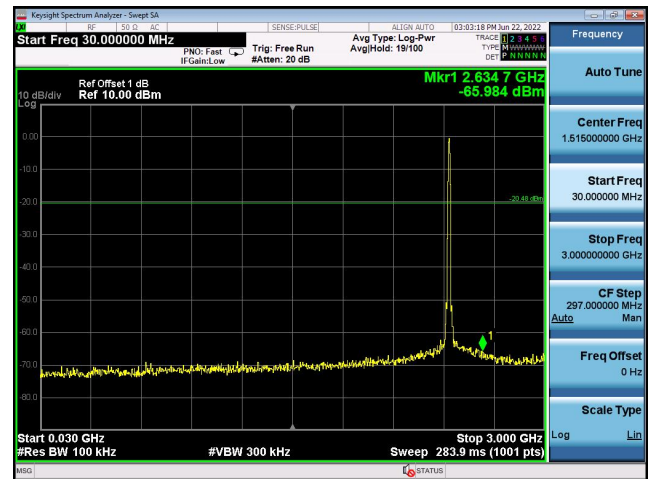

30MHz-3GHz



3GHz -25GHz



3GHz -25GHz

802.11b

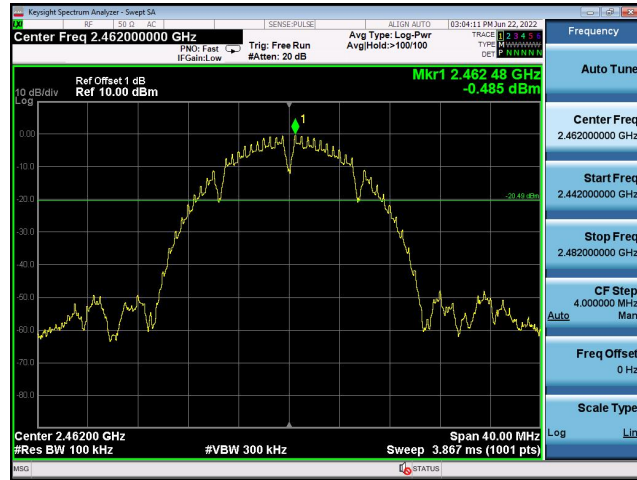

802.11g

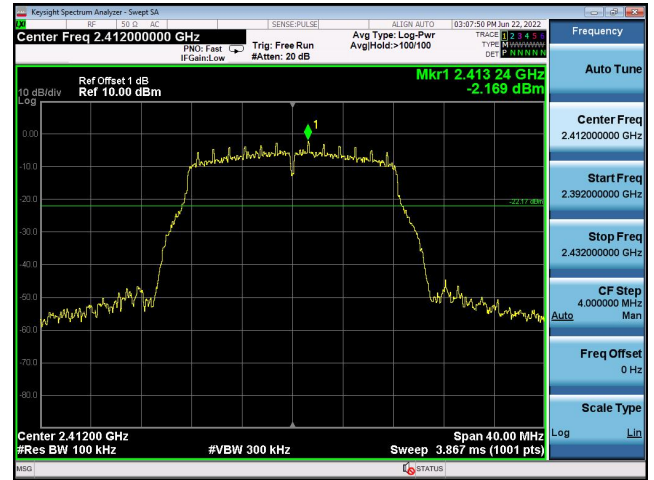

CH11

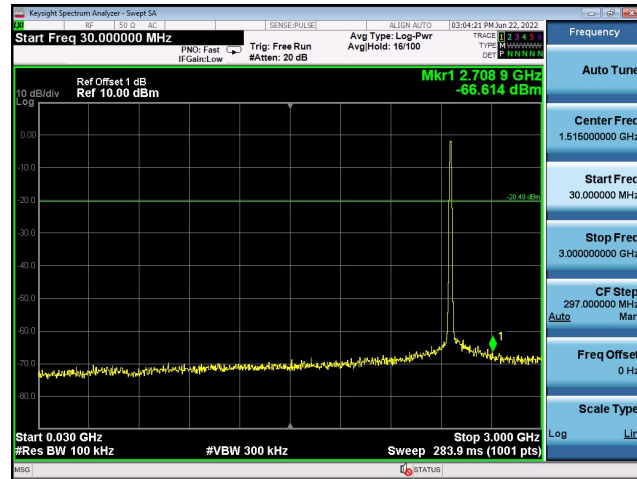

CH01



30MHz-3GHz



30MHz-3GHz



3GHz -25GHz

3GHz -25GHz

802.11g

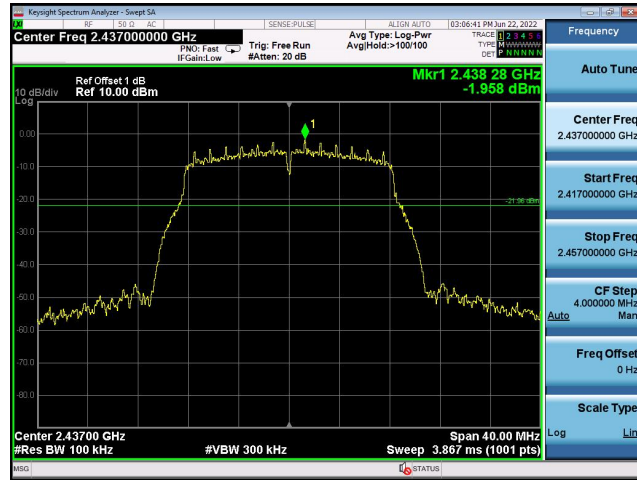

CH06

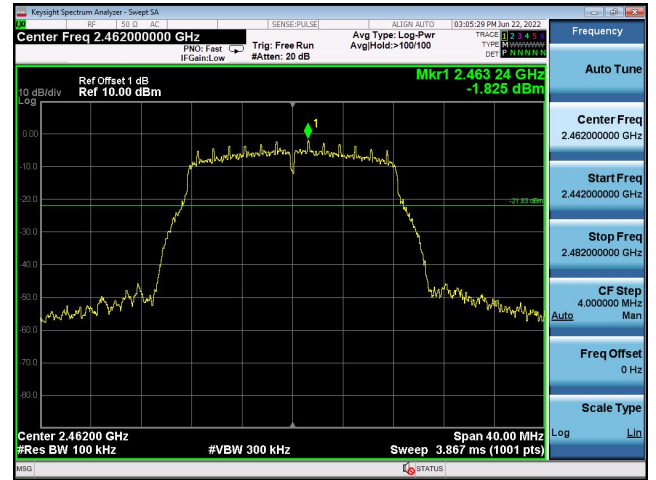

CH11

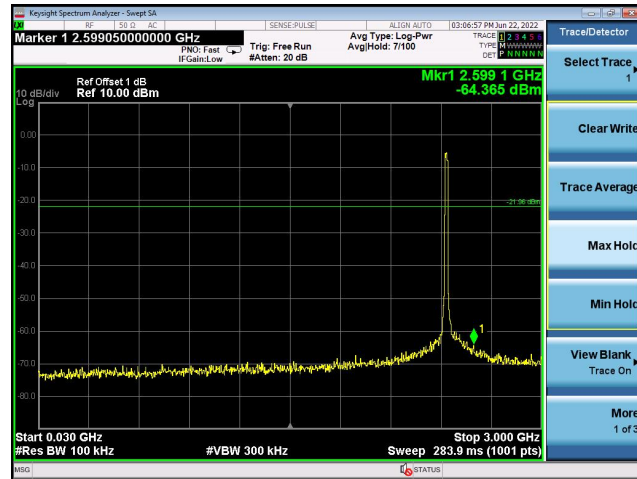

30MHz-3GHz

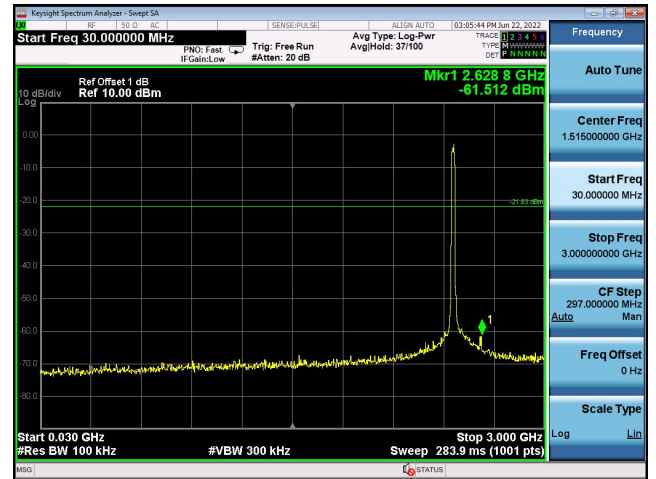

30MHz-3GHz



3GHz -25GHz



3GHz -25GHz

802.11n(HT20)



CH01

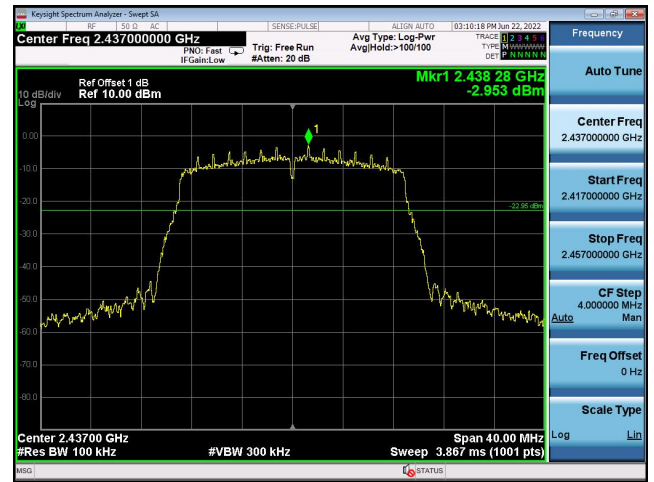

CH06

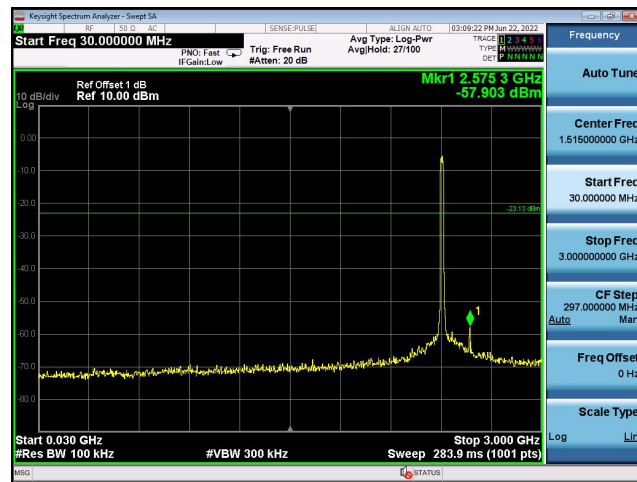

30MHz-3GHz



30MHz-3GHz



3GHz -25GHz



3GHz -25GHz