



# TEST REPORT

**Product Name** : Smart phone  
**Brand Name** : Blackview  
**Model** : WAVE 8  
**Series Model** : N/A  
**FCC ID** : 2A7DX-WAVE8  
**Applicant** : **DOKE COMMUNICATION (HK) LIMITED**  
**Address** : 19H MAXGRAND PLAZA NO 3 TAI YAU STREET SAN PO KONG KL  
**Manufacturer** : **Shenzhen DOKE Electronic Co., Ltd**  
**Address** : 801, Building3, 7th Industrial Zone, Yulv Community, Yutang Road, Guangming District, Shenzhen, China.  
**Standard(s)** : FCC CFR Title 47 Part 15 Subpart C Section 15.247  
**Date of Receipt** : July 11, 2024  
**Date of Test** : July 11, 2024~ Aug.13, 2024  
**Issued Date** : Aug.13, 2024

**Issued By:** **Guangdong Asia Hongke Test Technology Limited**  
B1/F, Building 11, Junfeng Industrial Park, Chongqing Road, Heping Community, Fuhai Street,  
Bao'an District, Shenzhen, Guangdong, China  
Tel.: +86 0755-230967639 Fax.: +86 0755-230967639

**Reviewed by:** Leon Yi  
Leon.yi

**Approved by:** Sean She  
Sean She



Note: This device has been tested and found to comply with the standard(s) listed, this test report merely corresponds to the test sample. It is not permitted to copy extracts of these test result without the written permission of the test laboratory. This report shall not be reproduced except in full, without the written approval of Guangdong Asia Hongke Test Technology Limited. If there is a need to alter or revise this document, the right belongs to Guangdong Asia Hongke Test Technology Limited, and it should give a prior written notice of the revision document. This test report must not be used by the client to claim product endorsement.



**Report Revise Record**

<b>Report Version</b>	<b>Issued Date</b>	<b>Notes</b>
M1	Aug.13, 2024	Initial Release

# Contents

<b>1</b>	<b>TEST SUMMARY.....</b>	<b>4</b>
1.1	TEST STANDARDS .....	4
1.2	TEST SUMMARY .....	4
1.3	TEST FACILITY .....	5
1.4	MEASUREMENT UNCERTAINTY .....	5
<b>2</b>	<b>GENGENERAL INFORMATION .....</b>	<b>6</b>
2.1	ENVIRONMENTAL CONDITIONS .....	6
2.2	GENERAL DESCRIPTION OF EUT .....	6
2.3	DESCRIPTION OF TEST MODES AND TEST FREQUENCY.....	7
2.4	SPECIAL ACCESSORIES .....	8
2.5	EQUIPMENT LIST FOR THE TEST .....	8
<b>3</b>	<b>TEST CONDITIONS AND RESULTS .....</b>	<b>9</b>
3.1	CONDUCTED EMISSIONS TEST .....	9
3.2	RADIATED EMISSIONS AND BAND EDGE .....	12
3.3	MAXIMUM PEAK CONDUCTED OUTPUT POWER.....	19
3.4	POWER SPECTRAL DENSITY .....	20
3.5	6DB BANDWIDTH.....	21
3.6	OUT-OF-BAND EMISSIONS .....	22
3.7	ANTENNA REQUIREMENT.....	23
<b>4</b>	<b>TEST SETUP PHOTOGRAPHS OF EUT .....</b>	<b>24</b>
<b>5</b>	<b>EXTERNAL PHOTOGRAPHS OF EUT .....</b>	<b>24</b>
<b>6</b>	<b>INTERNAL PHOTOGRAPHS OF EUT .....</b>	<b>24</b>

# 1 TEST SUMMARY

## 1.1 Test Standards

The tests were performed according to following standards:

[FCC Rules Part 15.247](#): Frequency Hopping, Direct Spread Spectrum and Hybrid Systems that are in operation within the bands of 902-928 MHz, 2400-2483.5 MHz, and 5725-5850 MHz

[ANSI C63.10: 2013](#): American National Standard for Testing Unlicensed Wireless Devices

[KDB558074 D01 15.247 Meas Guidance v05r02](#): Guidance for Compliance Measurements on Digital Transmission System, Frequency Hopping Spread Spectrum System, and Hybrid System Devices Operating Under Section 15.247 of the FCC Rules

## 1.2 Test Summary

Test Item	Section in RSS-47	Result
Antenna requirement	§15.203	Pass
On Time and Duty Cycle	/	/
AC Power Line Conducted Emission	§ 15.207(a)	Pass
Conducted Peak Output Power	§15.247 (b)(3)	Pass
Channel Bandwidth	§15.247 (a)(2)	Pass
Power Spectral Density	§15.247 (e)	Pass
Transmitter Radiated Spurious Emission	§15.205/15.209	Pass
Restricted Bands	§15.205/15.209	PASS
Conducted Unwanted emissions and Bandedge	§15.205, §15.247(d)	Pass

### 1.3 Test Facility

**Test Laboratory:**

**Guangdong Asia Hongke Test Technology Limited**

B1/F, Building 11, Junfeng Industrial Park, Chongqing Road, Heping Community, Fuhai Street, Bao'an District, Shenzhen, Guangdong, China

The test facility is recognized, certified or accredited by the following organizations:

**FCC-Registration No.: 251906 Designation Number: CN1376**

Guangdong Asia Hongke Test Technology Limited has been registered and fully described in a report filed with the (FCC) Federal Communications Commission. The acceptance letter from the FCC is maintained in our files.

**IC —Registration No.: 31737 CAB identifier: CN0165**

The 3m Semi-anechoic chamber of Guangdong Asia Hongke Test Technology Limited has been registered by Certification and Engineering Bureau of Industry Canada for radio equipment testing with Registration No.: 31737

**A2LA-Lab Cert. No.: 7133.01**

Guangdong Asia Hongke Test Technology Limited has been accredited by A2LA for technical competence in the field of electrical testing, and proved to be in compliance with ISO/IEC 17025: 2017 General Requirements for the Competence of Testing and Calibration Laboratories and any additional program requirements in the identified field of testing.

### 1.4 Measurement uncertainty

The data and results referenced in this document are true and accurate. The reader is cautioned that there may be errors within the calibration limits of the equipment and facilities. The measurement uncertainty was calculated for all measurements listed in this test report according to CISPR 16 - 4 “Specification for radio disturbance and immunity measuring apparatus and methods – Part 4: Uncertainty in EMC Measurements” and is documented in the Guangdong Asia Hongke Test Technology Limited’s quality system according to DIN EN ISO/IEC 17025. Furthermore, component and process variability of devices similar to that tested may result in additional deviation. The manufacturer has the sole responsibility of continued compliance of the device.

Hereafter the best measurement capability for Asia Hongke laboratory is reported:

Test	Measurement Uncertainty	Notes
Power Line Conducted Emission	150KHz~30MHz ±1.20 dB	(1)
Radiated Emission	9KHz~30Hz ±3.10dB	(1)
Radiated Emission	9KHz~1GHz ±3.75dB	(1)
Radiated Emission	1GHz~18GHz ±3.88 dB	(1)
Radiated Emission	18GHz~40GHz ±3.88dB	(1)
RF power, conducted	30MHz~6GHz ±0.16dB	(1)
RF power density, conducted	±0.24dB	(1)
Spurious emissions, conducted	±0.21dB	(1)
Temperature	±1°C	(1)
Humidity	±3%	(1)
DC and low frequency voltages	±1.5%	(1)
Time	±2%	(1)
Duty cycle	±2%	(1)

The report uncertainty of measurement  $y \pm U$ , where expanded uncertainty U is based on a standard uncertainty Multiplied by a coverage factor of  $k=2$  , providing a level of confidence of approximately 95%

## 2 GENGGENERAL INFORMATION

### 2.1 Environmental conditions

During the measurement the environmental conditions were within the listed ranges:

Normal Temperature:	25°C
Relative Humidity:	55 %
Air Pressure:	101 kPa

### 2.2 General Description of EUT

Product Name:	Smart phone
Model/Type reference:	WAVE 8
Serial Model:	N/A
Power Supply:	DC 3.85V from battery 5000mAh
Adapter Information:	Model: QZ-01004AA00 Input: 100-240V~50/60Hz 0.3A Output: 5.0V=2.0A (10.0W)
Hardware Version:	S682_V1
Software Version:	FLAT2_EEA_S6068_V1.0
Sample(s) Status:	AiTDG-240711002-1(Normal sample) AiTDG-240711002-2(Engineer sample)
<b>Bluetooth LE:</b>	
Supported type:	Bluetooth LE 1M
Modulation:	GFSK
Operation frequency:	2402MHz to 2480MHz
Channel number:	40
Channel separation:	2MHz
Antenna type:	FPC Antenna
Antenna gain:	1.37dBi
<b>Remark:</b> The above DUT's information was declared by manufacturer. For more detailed features description, please refer to the manufacturer's specifications or the User's Manual.	

## 2.3 Description of Test Modes and Test Frequency

There are 40 channels provided to the EUT and Channel 00/19/39 were selected to test.

### Operation Frequency List:

Channel	Frequency (MHz)
<b>00</b>	<b>2402</b>
02	2404
03	2406
⋮	⋮
<b>19</b>	<b>2440</b>
⋮	⋮
37	2476
38	2478
<b>39</b>	<b>2480</b>

Note: The line display in grey were the channel selected for testing

Exploratory testing was performed under each mode combination test channel; only the final measurement of the worst combination was made and recorded in this report.

Test case	Exploratory measurement			Final measurement Recorded In Report		
	Mode	Date rate	Channel	Mode	Date rate	Channel
Maximum output power	GFSK	LE 1M	<input checked="" type="checkbox"/> Lowest <input checked="" type="checkbox"/> Middle <input checked="" type="checkbox"/> Highest	GFSK	LE 1M	<input checked="" type="checkbox"/> Lowest <input checked="" type="checkbox"/> Middle <input checked="" type="checkbox"/> Highest
Power spectral density	GFSK	LE 1M	<input checked="" type="checkbox"/> Lowest <input checked="" type="checkbox"/> Middle <input checked="" type="checkbox"/> Highest	GFSK	LE 1M	<input checked="" type="checkbox"/> Lowest <input checked="" type="checkbox"/> Middle <input checked="" type="checkbox"/> Highest
-6dB bandwidth	GFSK	LE 1M	<input checked="" type="checkbox"/> Lowest <input checked="" type="checkbox"/> Middle <input checked="" type="checkbox"/> Highest	GFSK	LE 1M	<input checked="" type="checkbox"/> Lowest <input checked="" type="checkbox"/> Middle <input checked="" type="checkbox"/> Highest
Conducted Spurious Emissions	GFSK	LE 1M	<input checked="" type="checkbox"/> Lowest <input checked="" type="checkbox"/> Middle <input checked="" type="checkbox"/> Highest	GFSK	LE 1M	<input checked="" type="checkbox"/> Lowest <input checked="" type="checkbox"/> Middle <input checked="" type="checkbox"/> Highest
Conducted Band edge	GFSK	LE 1M	<input checked="" type="checkbox"/> Lowest <input checked="" type="checkbox"/> Highest	GFSK	LE 1M	<input checked="" type="checkbox"/> Lowest <input checked="" type="checkbox"/> Highest
Radiated Band edge	GFSK	LE 1M	<input checked="" type="checkbox"/> Lowest <input checked="" type="checkbox"/> Highest	GFSK	LE 1M	<input checked="" type="checkbox"/> Lowest <input checked="" type="checkbox"/> Highest
Radiated Emissions Above 1GHz	GFSK	LE 1M	<input checked="" type="checkbox"/> Lowest <input checked="" type="checkbox"/> Middle <input checked="" type="checkbox"/> Highest	GFSK	LE 1M	<input checked="" type="checkbox"/> Lowest <input checked="" type="checkbox"/> Middle <input checked="" type="checkbox"/> Highest
Radiated Emissions Below 1GHz	GFSK	LE 1M	<input checked="" type="checkbox"/> Lowest <input checked="" type="checkbox"/> Middle <input checked="" type="checkbox"/> Highest	GFSK	LE 1M	<input checked="" type="checkbox"/> Middle
Conducted Emissions 9KHz-30 MHz	GFSK	LE 1M	<input checked="" type="checkbox"/> Lowest <input checked="" type="checkbox"/> Middle <input checked="" type="checkbox"/> Highest	GFSK	LE 1M	<input checked="" type="checkbox"/> Middle

### Power setting during the test:

During testing, Channel & Power Controlling Software provided by the customer was used to control the operating channel as well as the output power level. The RF output power selection is for the setting of RF output power expected by the customer and is going to be fixed on the firmware of the final end product.

Power Parameters:

Test Software Version	###*3646633###		
Frequency	2402MHz	2441MHz	2480MHz
BLE_1M	default	default	default

## 2.4 Special Accessories

Follow auxiliary equipment(s) test with EUT that provided by the manufacturer or laboratory is listed as follow:

Description	Manufacturer	Model	Serial No.	Provided by	Other
/	/	/	/	/	/
/	/	/	/	/	/

## 2.5 Equipment List for the Test

No	Test Equipment	Manufacturer	Model No	Serial No	Cal. Date	Cal. Due Date
1	Spectrum Analyzer	R&S	FSV40	101470	2023.09.08	2024.09.07
2	Spectrum Analyzer	Keysight	N9020A	MY51280643	2023.09.08	2024.09.07
3	EMI Measuring Receiver	R&S	ESR	101660	2023.09.08	2024.09.07
4	Low Noise Pre-Amplifier	HP	HP8447E	1937A01855	2023.09.08	2024.09.07
5	Low Noise Pre-Amplifier	Tsj	MLA-0120-A02-34	2648A04738	2023.09.08	2024.09.07
6	Passive Loop	ETS	6512	00165355	2022.09.04	2024.09.03
7	TRILOG Super Broadband test Antenna	SCHWARZBECK	VULB9160	9160-3206	2021.08.29	2024.08.28
8	Broadband Horn Antenna	SCHWARZBECK	BBHA9120D	452	2021.08.29	2024.08.28
9	SHF-EHF Horn Antenna 15-40GHZ	SCHWARZBECK	BBHA9170	BBHA9170367d	2021.08.29	2024.08.28
10	EMI Measuring Receiver	R&S	ESR	101160	2023.09.13	2024.09.12
11	LISN	SCHWARZBECK	NNLK 8129	8130179	2023.10.29	2024.10.28
12	Pulse Limiter	R&S	ESH3-Z2	102789	2023.09.13	2024.09.12
13	Pro.Temp&Humi.chamber	MENTEK	MHP-150-1C	MAA08112501	2023.09.08	2024.09.07
14	RF Automatic Test system	MW	MW100-RFCB	21033016	2023.09.08	2024.09.07
15	Signal Generator	Agilent	N5182A	MY50143009	2023.09.08	2024.09.07
16	Wideband Radio communication tester	R&S	CMW500	1201.0002K50	2023.09.08	2024.09.07
17	RF Automatic Test system	MW	MW100-RFCB	21033016	2023.09.08	2024.09.07
18	DC power supply	ZHAOXIN	RXN-305D-2	28070002559	N/A	N/A
19	RE Software	EZ	EZ-EMC_RE	Ver.AIT-03A	N/A	N/A
20	CE Software	EZ	EZ-EMC_CE	Ver.AIT-03A	N/A	N/A
21	RF Software	MW	MTS 8310	2.0.0.0	N/A	N/A
22	temporary antenna connector(Note)	NTS	R001	N/A	N/A	N/A

Note: The temporary antenna connector is soldered on the PCB board in order to perform conducted tests and this temporary antenna connector is listed in the equipment list.



### 3 TEST CONDITIONS AND RESULTS

#### 3.1 Conducted Emissions Test

##### LIMIT

Frequency range (MHz)	Limit (dBuV)	
	Quasi-peak	Average
0.15-0.5	66 to 56*	56 to 46*
0.5-5	56	46
5-30	60	50

\* Decreases with the logarithm of the frequency.

##### TEST CONFIGURATION

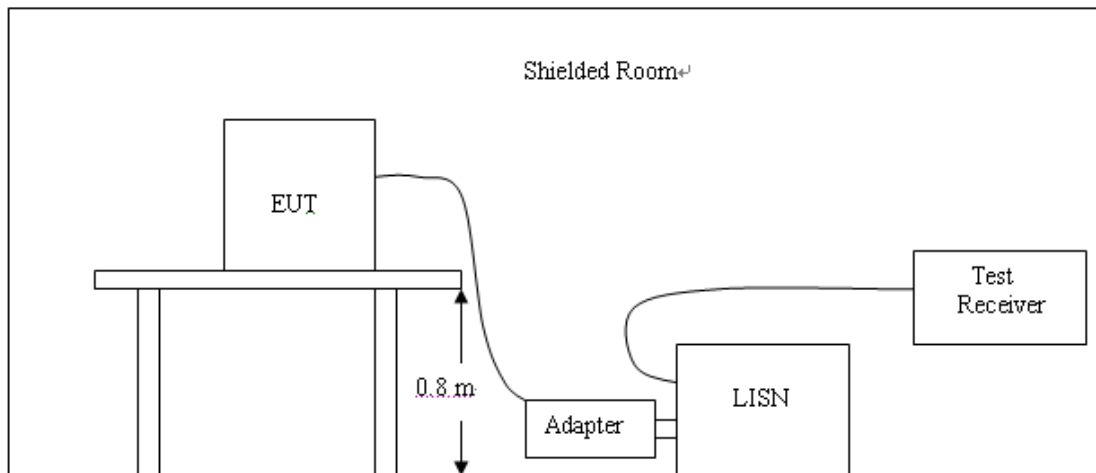

##### TEST PROCEDURE

1. The equipment was set up as per the test configuration to simulate typical actual usage per the user's manual. The EUT is a tabletop system; a wooden table with a height of 0.8 meters is used and is placed on the ground plane as per ANSI C63.10:2013.
2. Support equipment, if needed, was placed as per ANSI C63.10:2013.
3. All I/O cables were positioned to simulate typical actual usage as per ANSI C63.10:2013.
4. The adapter received AC120V/60Hz power through a Line Impedance Stabilization Network (LISN) which supplied power source and was grounded to the ground plane.
5. All support equipments received AC power from a second LISN, if any.
6. The EUT test program was started. Emissions were measured on each current carrying line of the EUT using a spectrum Analyzer / Receiver connected to the LISN powering the EUT. The LISN has two monitoring points: Line 1 (Hot Side) and Line 2 (Neutral Side). Two scans were taken: one with Line 1 connected to Analyzer / Receiver and Line 2 connected to a 50 ohm load; the second scan had Line 1 connected to a 50 ohm load and Line 2 connected to the Analyzer / Receiver.
7. Analyzer / Receiver scanned from 150 KHz to 30MHz for emissions in each of the test modes.
8. During the above scans, the emissions were maximized by cable manipulation.

**TEST RESULTS**

Remark: Both 120 VAC, 50/60 Hz and 240 VAC, 50/60 Hz power supply have been tested, only the worst result of 120 VAC, 60 Hz was reported as below:

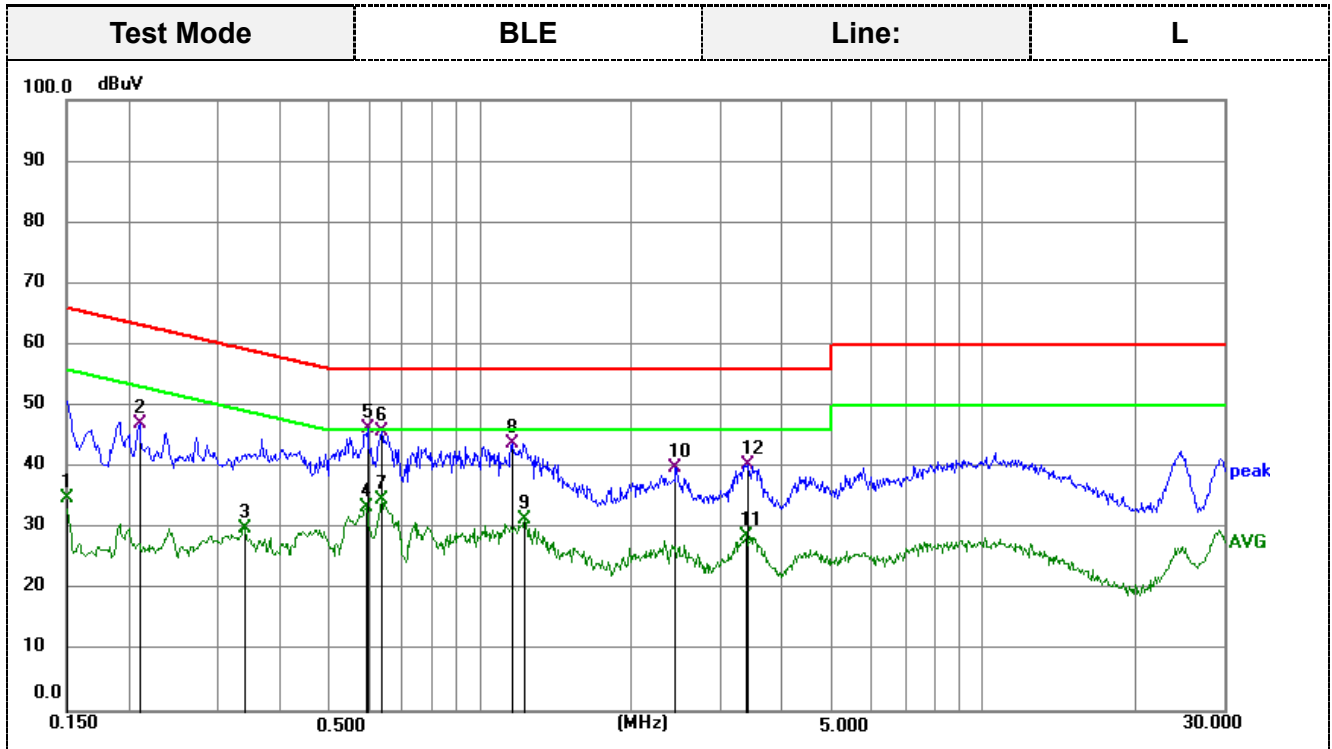

Remark: Correct Factor = Insertion loss of LISN + Cable loss + Insertion loss of Pulse Limiter;  
 Measurement Result = Reading Level + Correct Factor;  
 Margin = Measurement Result - Limit

No.	Frequency (MHz)	Reading (dBuV)	Correct (dB)	Result (dBuV)	Limit (dBuV)	Margin (dB)	Remark
1	0.1500	22.96	11.84	34.80	56.00	-21.20	QP
2	0.2084	36.28	10.70	46.98	63.27	-16.29	AVG
3	0.3390	19.19	10.70	29.89	49.23	-19.34	QP
4	0.5910	22.59	10.69	33.28	46.00	-12.72	AVG
5	0.5955	35.70	10.69	46.39	56.00	-9.61	QP
6	0.6360	35.06	10.68	45.74	56.00	-10.26	QP
7	0.6360	23.86	10.68	34.54	46.00	-11.46	QP
8	1.1580	33.24	10.67	43.91	56.00	-12.09	AVG
9	1.2255	20.82	10.68	31.50	46.00	-14.50	AVG
10	2.4360	29.08	10.79	39.87	56.00	-16.13	AVG
11	3.3675	17.65	10.94	28.59	46.00	-17.41	QP
12	3.3854	29.34	10.96	40.30	56.00	-15.70	AVG

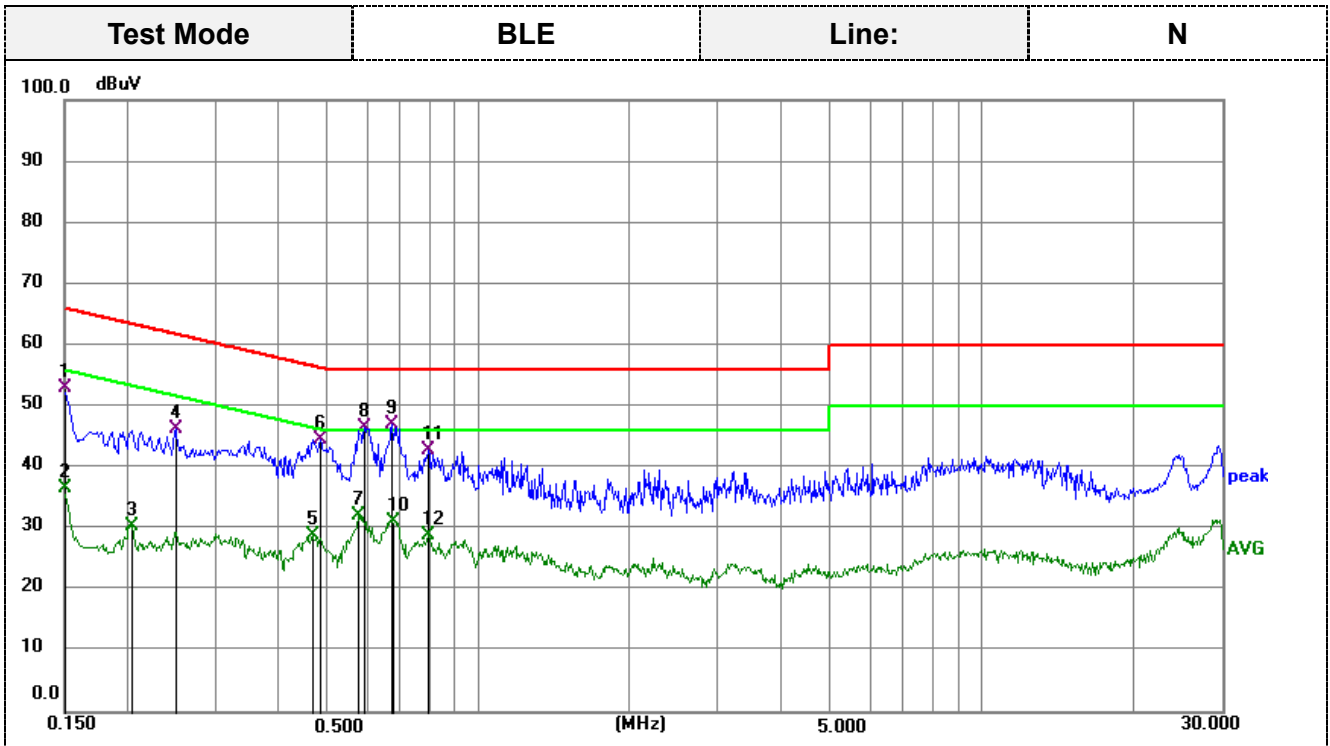

Remark: Correct Factor = Insertion loss of LISN + Cable loss + Insertion loss of Pulse Limiter;  
 Measurement Result = Reading Level + Correct Factor;

Margin = Measurement Result - Limit

No.	Frequency (MHz)	Reading (dBuV)	Correct (dB)	Result (dBuV)	Limit (dBuV)	Margin (dB)	Remark
1	0.1500	41.17	11.84	53.01	66.00	-12.99	QP
2	0.1500	24.87	11.84	36.71	56.00	-19.29	AVG
3	0.2040	19.63	10.69	30.32	53.45	-23.13	QP
4	0.2490	35.50	10.69	46.19	61.79	-15.60	AVG
5	0.4650	18.18	10.69	28.87	46.60	-17.73	AVG
6	0.4830	33.97	10.69	44.66	56.29	-11.63	QP
7	0.5775	21.40	10.68	32.08	46.00	-13.92	QP
8	0.5910	35.74	10.68	46.42	56.00	-9.58	AVG
9	0.6720	36.40	10.67	47.07	56.00	-8.93	AVG
10	0.6809	20.48	10.67	31.15	46.00	-14.85	QP
11	0.7933	32.19	10.65	42.84	56.00	-13.16	AVG
12	0.7933	18.23	10.65	28.88	46.00	-17.12	QP

### 3.2 Radiated Emissions and Band Edge

#### Limit

For intentional device, according to § 15.209(a), the general requirement of field strength of radiated emission out of authorized band shall not exceed the following table at a 3 meters measurement distance.

In addition, radiated emissions which fall in the restricted bands, as defined in §15.205(a), must also comply with the radiated emission limits specified in §15.209(a)

Radiated emission limits

Frequency (MHz)	Distance (Meters)	Radiated (dBµV/m)	Radiated (µV/m)
0.009-0.49	3	$20\log(2400/F(\text{KHz}))+40\log(300/3)$	$2400/F(\text{KHz})$
0.49-1.705	3	$20\log(24000/F(\text{KHz}))+40\log(30/3)$	$24000/F(\text{KHz})$
1.705-30	3	$20\log(30)+40\log(30/3)$	30
30-88	3	40.0	100
88-216	3	43.5	150
216-960	3	46.0	200
Above 960	3	54.0	500

#### TEST CONFIGURATION

(A) Radiated Emission Test Set-Up, Frequency Below 30MHz

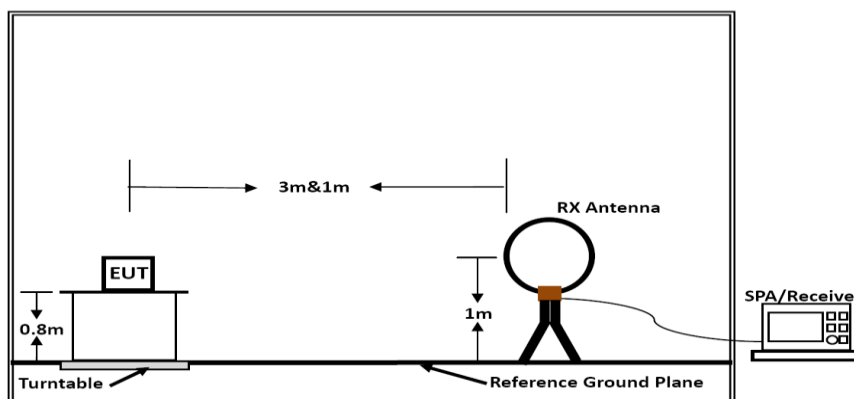

Below 30MHz

(B) Radiated Emission Test Set-Up, Frequency below 1000MHz

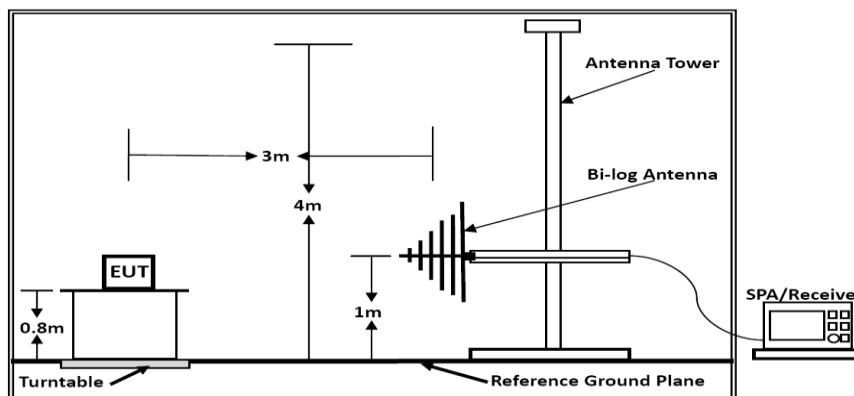

Below 1GHz

(C) Radiated Emission Test Set-Up, Frequency above 1000MHz

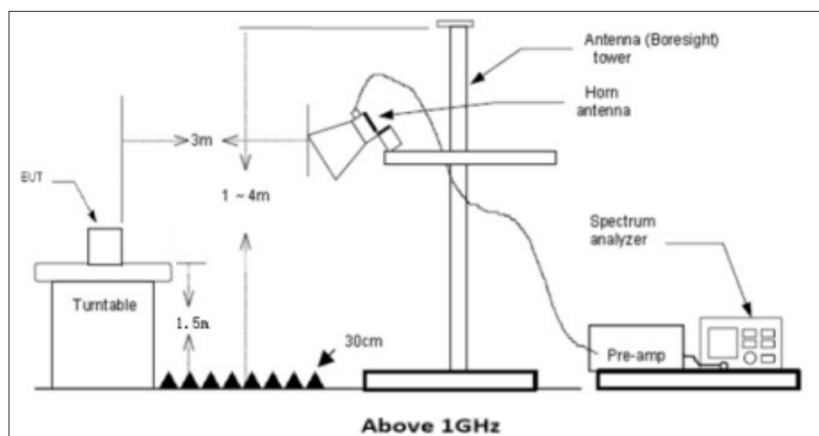

**Test Procedure**

1. Below 1GHz measurement the EUT is placed on a turntable which is 0.8m above ground plane, and above 1GHz measurement EUT was placed on a low permittivity and low loss tangent turntable which is 1.5m above ground plane.
2. Maximum procedure was performed by raising the receiving antenna from 1m to 4m and rotating the turn table from 0° to 360° to acquire the highest emissions from EUT
3. And also, each emission was to be maximized by changing the polarization of receiving antenna both horizontal and vertical.
4. Repeat above procedures until all frequency measurements have been completed.
5. Radiated emission test frequency band from 9KHz to 25GHz.
6. The distance between test antenna and EUT as following table states:

Test Frequency range	Test Antenna Type	Test Distance
9KHz-30MHz	Active Loop Antenna	3
30MHz-1GHz	Bilog Antenna	3
1GHz-18GHz	Horn Antenna	3
18GHz-25GHz	Horn Antenna	1

7. Setting test receiver/spectrum as following table states:

Test Frequency range	Test Receiver/Spectrum Setting	Detector
9KHz-150KHz	RBW=200Hz/VBW=3KHz, Sweep time=Auto	QP
150KHz-30MHz	RBW=9KHz/VBW=100KHz, Sweep time=Auto	QP
30MHz-1GHz	RBW=120KHz/VBW=1000KHz, Sweep time=Auto	QP
1GHz-40GHz	Peak Value: RBW=1MHz/VBW=3MHz, Sweep time=Auto Average Value: RBW=1MHz/VBW=10Hz, Sweep time=Auto	Peak

**TEST RESULTS**

Remark:

1. For below 1GHz testing recorded worst at BLE 1M middle channel.
2. Radiated emission test from 9 KHz to 10th harmonic of fundamental was verified, and The emission levels from 9kHz to 30MHz are attenuated 20dB below the limit and not recorded in report.

**For 30MHz-1GHz**

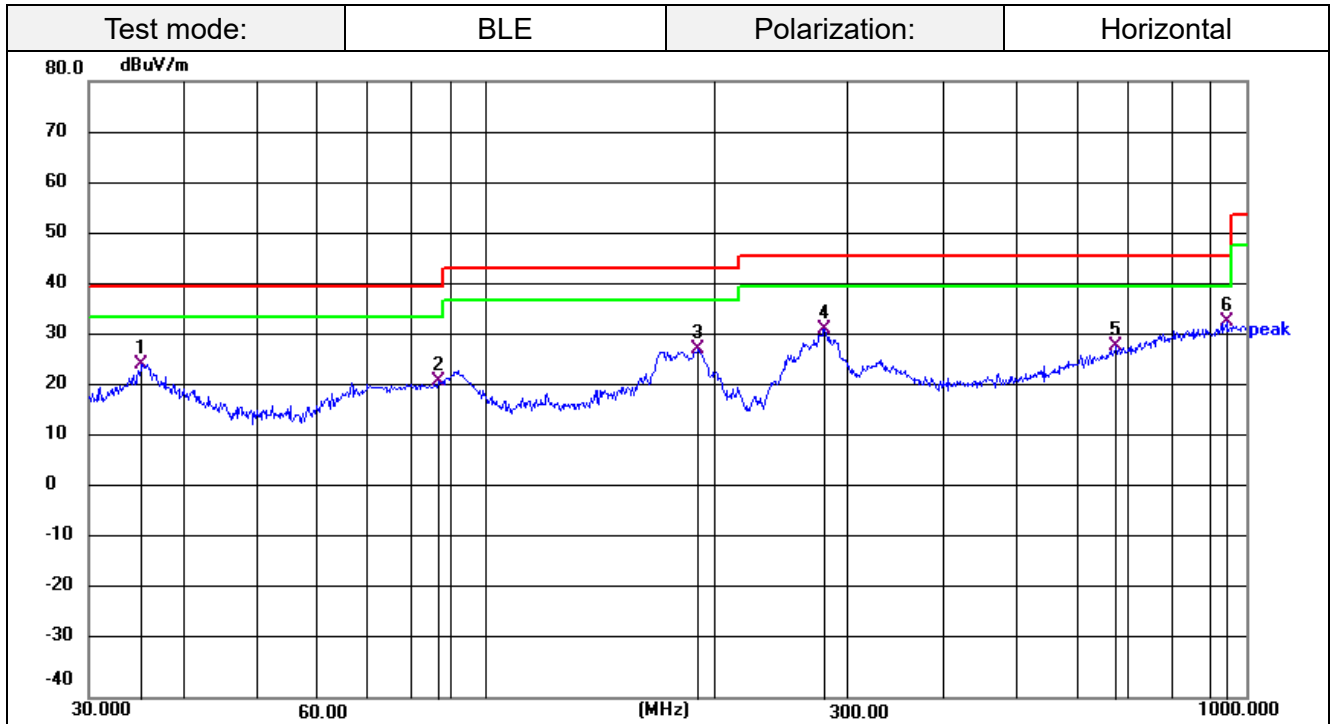

**Remark:**

Emission Level = Reading + Factor;  
 Factor = Antenna Factor + Cable Loss – Pre-amplifier;  
 Margin= Emission Level - Limit.

No.	Frequency (MHz)	Reading (dBuV)	Factor (dB/m)	Level (dBuV/m)	Limit (dBuV/m)	Margin (dB)	Det.
1	35.2511	42.14	-17.17	24.97	40.00	-15.03	QP
2	86.8067	42.70	-20.97	21.73	40.00	-18.27	QP
3	190.4050	47.32	-19.47	27.85	43.50	-15.65	QP
4	279.0436	49.27	-17.54	31.73	46.00	-14.27	QP
5	675.2080	36.97	-8.60	28.37	46.00	-17.63	QP
6 *	942.1304	36.97	-3.72	33.25	46.00	-12.75	QP

Test mode:	BLE	Polarization:	Vertical
------------	-----	---------------	----------

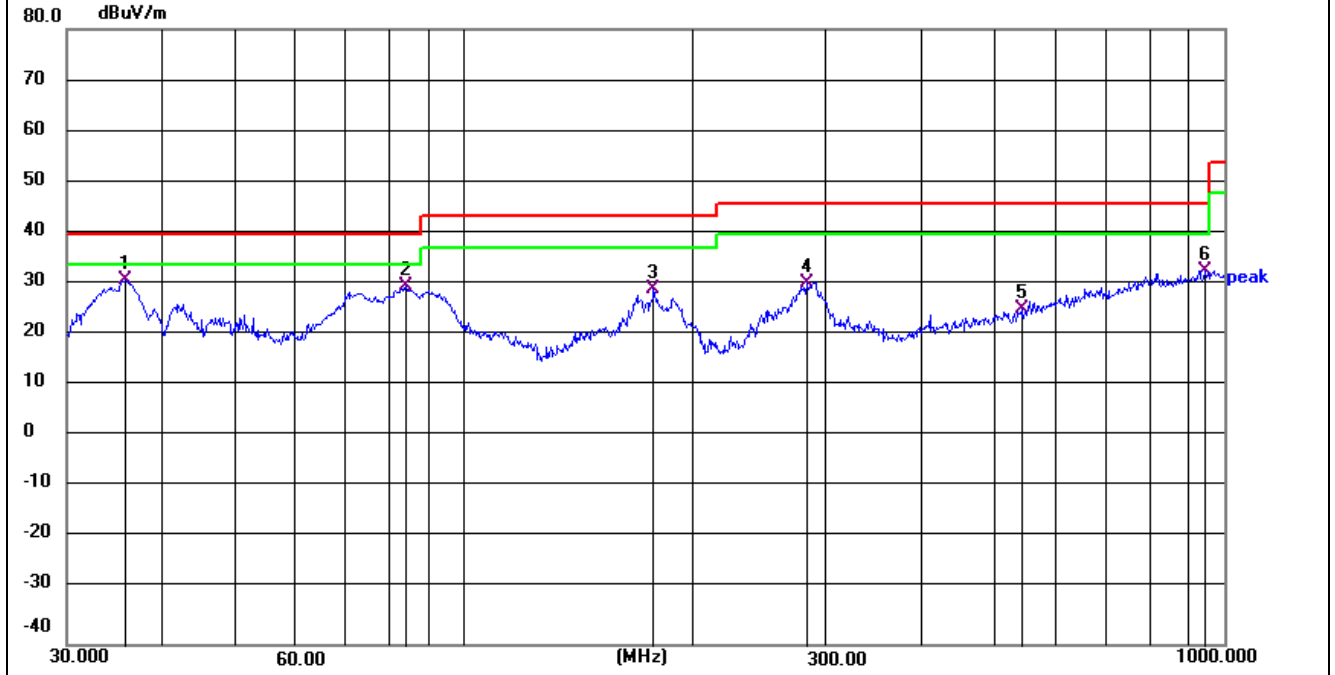

Remark:  
 Emission Level = Reading + Factor;  
 Factor = Antenna Factor + Cable Loss – Pre-amplifier;  
 Margin= Emission Level - Limit.

No.	Frequency (MHz)	Reading (dBuV)	Factor (dB/m)	Level (dBuV/m)	Limit (dBuV/m)	Margin (dB)	Det.
1 *	35.8746	48.20	-17.09	31.11	40.00	-8.89	QP
2	83.8155	50.94	-20.96	29.98	40.00	-10.02	QP
3	177.5089	47.20	-17.95	29.25	43.50	-14.25	QP
4	282.9849	48.08	-17.42	30.66	46.00	-15.34	QP
5	543.2740	36.91	-11.37	25.54	46.00	-20.46	QP
6	945.4400	36.63	-3.63	33.00	46.00	-13.00	QP

**For 1GHz to 25GHz**

**BLE 1M GFSK (above 1GHz)**

Frequency(MHz):		2402		Polarity:	Horizontal	
Frequency	Meter Reading	Factor	Emission Level	Limits	Margin	Detector Type
(MHz)	(dBµV)	(dB/m)	(dBµV/m)	(dBµV/m)	(dB)	
4804	46.13	5.06	51.19	74	-22.81	PEAK
4804	36.23	5.06	41.29	54	-12.71	AVG
7206	45.78	7.03	52.81	74	-21.19	PEAK
7206	30.77	7.03	37.80	54	-16.20	AVG

Frequency(MHz):		2402		Polarity:	VERTICAL	
Frequency	Meter Reading	Factor	Emission Level	Limits	Margin	Detector Type
(MHz)	(dBµV)	(dB/m)	(dBµV/m)	(dBµV/m)	(dB)	
4804	47.41	5.06	52.47	74	-21.53	PEAK
4804	35.48	5.06	40.54	54	-13.46	AVG
7206	44.54	7.03	51.57	74	-22.43	PEAK
7206	31.76	7.03	38.79	54	-15.21	AVG

Frequency(MHz):		2440		Polarity:	Horizontal	
Frequency	Meter Reading	Factor	Emission Level	Limits	Margin	Detector Type
(MHz)	(dBµV)	(dB/m)	(dBµV/m)	(dBµV/m)	(dB)	
4880	48.12	5.14	53.26	74	-20.74	PEAK
4880	35.67	5.14	40.81	54	-13.19	AVG
7320	44.38	7.52	51.90	74	-22.10	PEAK
7320	29.42	7.52	36.94	54	-17.06	AVG

Frequency(MHz):		2440		Polarity:	VERTICAL	
Frequency	Meter Reading	Factor	Emission Level	Limits	Margin	Detector Type
(MHz)	(dBµV)	(dB/m)	(dBµV/m)	(dBµV/m)	(dB)	
4880	46.75	5.14	51.89	74	-22.11	PEAK
4880	35.94	5.14	41.08	54	-12.92	AVG
7320	46.57	7.52	54.09	74	-19.91	PEAK
7320	31.63	7.52	39.15	54	-14.85	AVG



Frequency(MHz):		2480		Polarity:	Horizontal	
Frequency	Meter Reading	Factor	Emission Level	Limits	Margin	Detector Type
(MHz)	(dBμV)	(dB/m)	(dBμV/m)	(dBμV/m)	(dB)	
4960	46.46	5.22	51.68	74	-22.32	PEAK
4960	37.28	5.22	42.50	54	-11.50	AVG
7440	45.85	8.06	53.91	74	-20.09	PEAK
7440	30.92	8.06	38.98	54	-15.02	AVG

Frequency(MHz):		2480		Polarity:	VERTICAL	
Frequency	Meter Reading	Factor	Emission Level	Limits	Margin	Detector Type
(MHz)	(dBμV)	(dB/m)	(dBμV/m)	(dBμV/m)	(dB)	
4960	47.84	5.22	53.06	74	-20.94	PEAK
4960	36.65	5.22	41.87	54	-12.13	AVG
7440	45.90	8.06	53.96	74	-20.04	PEAK
7440	31.02	8.06	39.08	54	-14.92	AVG

REMARKS:

1. Emission level (dBuV/m) = Reading (dBuV)+ Factor (dB/m)
2. Factor (dB/m) = Antenna Factor (dB/m)+Cable Factor (dB)-Pre-amplifier Factor
3. Margin value = Emission level- Limit value.
4. -- Mean the PK detector measured value is below average limit.
5. Other emission levels are attenuated 20dB below the limit and not recorded in report.
6. RBW1MHz VBW3MHz Peak detector is for PK value; RBW 1MHz VBW10Hz Peak detector is for AV value.

**Radiation Restricted band**

**BLE 1M GFSK**

Frequency(MHz):		2402		Polarity:	Horizontal	
Frequency	Meter Reading	Factor	Emission Level	Limits	Margin	Detector Type
(MHz)	(dBμV)	(dB/m)	(dBμV/m)	(dBμV/m)	(dB)	
2385.01	40.05	-5.49	34.56	74	-39.44	peak
2390	38.5	-5.72	32.78	74	-41.22	peak
2400	41.9	-5.61	36.29	74	-37.71	peak

Frequency(MHz):		2402		Polarity:	Vertical	
Frequency	Meter Reading	Factor	Emission Level	Limits	Margin	Detector Type
(MHz)	(dBμV)	(dB/m)	(dBμV/m)	(dBμV/m)	(dB)	
2386.23	42.16	-5.48	36.68	74	-37.32	peak
2390	40.08	-5.94	34.14	74	-39.86	peak
2400	40.28	-5.65	34.63	74	-39.37	peak

Frequency(MHz):		2480		Polarity:	Horizontal	
Frequency	Meter Reading	Factor	Emission Level	Limits	Margin	Detector Type
(MHz)	(dBμV)	(dB/m)	(dBμV/m)	(dBμV/m)	(dB)	
2483.5	37.49	-5.29	32.2	74	-41.80	peak
2484.2	38.74	-5.03	33.71	74	-40.29	peak

Frequency(MHz):		2408		Polarity:	Vertical	
Frequency	Meter Reading	Factor	Emission Level	Limits	Margin	Detector Type
(MHz)	(dBμV)	(dB/m)	(dBμV/m)	(dBμV/m)	(dB)	
2483.5	35.88	-5.15	30.73	74	-43.27	peak
2484.5	37.07	-5.03	32.16	74	-41.84	peak

**REMARKS:**

1. Emission level (dBuV/m) = Reading (dBuV)+ Factor (dB/m)
2. Factor (dB/m) = Antenna Factor (dB/m)+Cable Factor (dB)-Pre-amplifier Factor
3. Margin value = Emission level- Limit value.
4. Other emission levels are attenuated 20dB below the limit and not recorded in report.
5. RBW1MHz VBW3MHz Peak detector is for PK value; RBW 1MHz VBW10Hz Peak detector is for AV value.

### 3.3 Maximum Peak Conducted Output Power

#### Limit

The Maximum Peak Output Power Measurement is 30dBm.

#### Test Procedure

Remove the antenna from the EUT and then connect a low loss RF cable from the antenna port to the Spectrum Analyzer. The following procedure shall be used when an instrument with a resolution bandwidth that is greater than the DTS bandwidth is available to perform the measurement:

- a) Set the RBW  $\geq$  DTS bandwidth.
- b) Set VBW  $\geq 3 \times$  RBW
- c) Set span  $\geq 3 \times$  RBW
- d) Sweep time = auto couple.
- e) Detector = peak.
- f) Trace mode = max hold.
- g) Allow trace to fully stabilize.
- h) Use peak marker function to determine the peak amplitude level.

#### Test Configuration

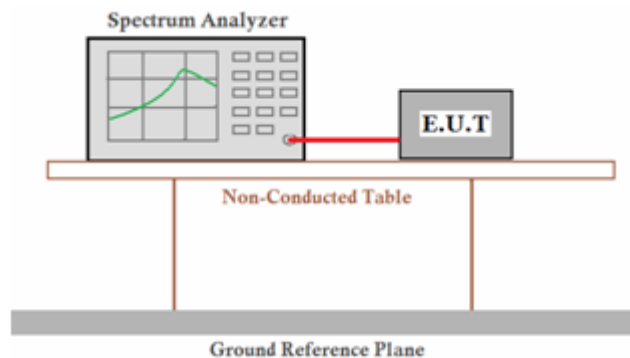

#### Test Results

Pass       Not Applicable

Note:

For test data, please refer to Appendix RF test data for BLE.

### 3.4 Power Spectral Density

#### Limit

For digitally modulated systems, the power spectral density conducted from the intentional radiator to the antenna shall not be greater than 8 dBm in any 3 kHz band during any time interval of continuous transmission.

#### Test Procedure

1. Use this procedure when the maximum peak conducted output power in the fundamental emission is used to demonstrate compliance.
2. Set the RBW  $\geq 3$  kHz.
3. Set the VBW  $\geq 3 \times$  RBW.
4. Set the span to 1.5 times the DTS channel bandwidth.
5. Detector = peak.
6. Sweep time = auto couple.
7. Trace mode = max hold.
8. Allow trace to fully stabilize.
9. Use the peak marker function to determine the maximum power level.
10. If measured value exceeds limit, reduce RBW (no less than 3 kHz) and repeat.
11. The resulting peak PSD level must be 8dBm.

#### Test Configuration

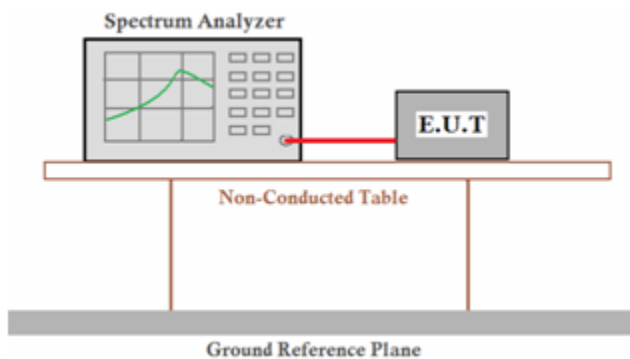

#### Test Results

Pass       Not Applicable

Note:

For test data, please refer to Appendix RF test data for BLE.

### 3.5 6dB Bandwidth

#### Limit

For digital modulation systems, the minimum 6 dB bandwidth shall be at least 500 kHz

#### Test Procedure

The transmitter output was connected to the spectrum analyzer through an attenuator. The bandwidth of the fundamental frequency was measured by spectrum analyzer with 100 KHz RBW and 300 KHz VBW. The 6dB bandwidth is defined as the total spectrum the power of which is higher than peak power minus 6dB. Measured the 6dB bandwidth by related function of the spectrum analyzer.

#### Test Configuration

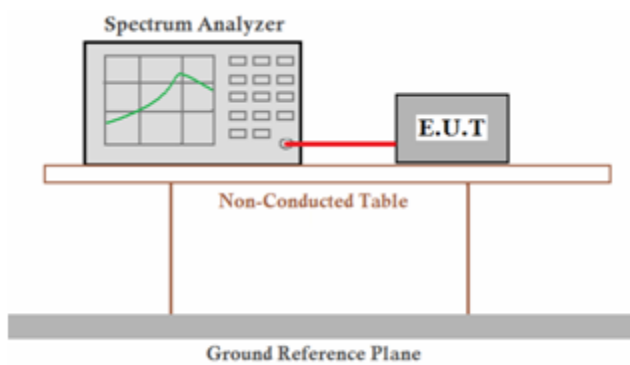

#### Test Results

Pass       Not Applicable

Note:

For test data, please refer to Appendix RF test data for BLE.

### 3.6 Out-of-band Emissions

#### Limit

In any 100 kHz bandwidth outside the frequency band in which the spread spectrum or digitally modulated intentional radiator is operating, the radio frequency power that is produced by the intentional radiator shall be at least 20 dB below that in the 100 kHz bandwidth within the band that contains the highest level of the desired power, based on either an RF conducted or a radiated measurement, provided the transmitter demonstrates compliance with the peak conducted power limits. If the transmitter complies with the conducted power limits based on the use of RMS averaging over a time interval, as permitted under paragraph (b)(3) of this section, the attenuation required under this paragraph shall be 30 dB instead of 20 dB. Attenuation below the general limits specified in §15.209(a) is not required.

#### Test Procedure

Connect the transmitter output to spectrum analyzer using a low loss RF cable, and set the spectrum analyzer to RBW=100 kHz, VBW= 300 kHz, peak detector, and max hold. Measurements utilizing these setting are made of the in-band reference level, bandedge and out-of-band emissions.

#### Test Configuration

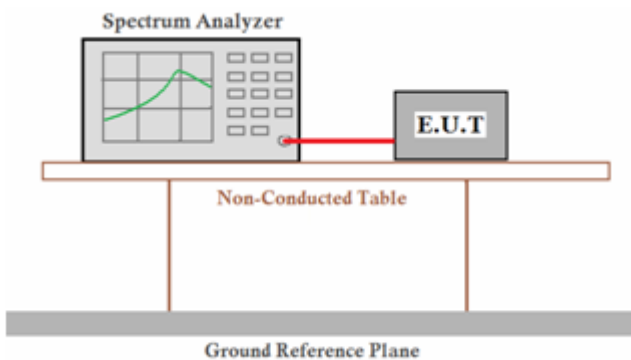

#### Test Results

Pass       Not Applicable

Note:

For test data, please refer to Appendix RF test data for BLE.

## 3.7 Antenna Requirement

### **Standard Applicable**

#### **For intentional device, according to FCC 47 CFR Section 15.203:**

An intentional radiator shall be designed to ensure that no antenna other than that furnished by the responsible party shall be used with the device. The use of a permanently attached antenna or of an antenna that uses a unique coupling to the intentional radiator, the manufacturer may design the unit so that a broken antenna can be replaced by the user, but the use of a standard antenna jack or electrical connector is prohibited

#### **FCC CFR Title 47 Part 15 Subpart C Section 15.247(b) (4):**

(4) The conducted output power limit specified in paragraph (b) of this section is based on the use of antennas with directional gains that do not exceed 6 dBi. Except as shown in paragraph (c) of this section, if transmitting antennas of directional gain greater than 6 dBi are used, the conducted output power from the intentional radiator shall be reduced below the stated values in paragraphs (b)(1), (b)(2), and (b)(3) of this section, as appropriate, by the amount in dB that the directional gain of the antenna exceeds 6 dBi.

### **Test Result**

The maximum gain of antenna was 1.37dBi with impedance 50Ω.

#### **4 Test Setup Photographs of EUT**

Please refer to separated files for Test Setup Photos of the EUT.

#### **5 External Photographs of EUT**

Please refer to separated files for External Photos of the EUT.

#### **6 Internal Photographs of EUT**

Please refer to separated files for Internal Photos of the EUT.

**\*\*\*\*\* End of Report \*\*\*\*\***