

Customer: Duoke
Project: TAB70
ME: Xiang Xiao-13316888409
RF: HouXiongLiu - 17328763286
Date: July 18, 2023
Report Type:
Version No.: V1.0
Status: T2
Frequency band:
2.4G/5G WIFI/BT

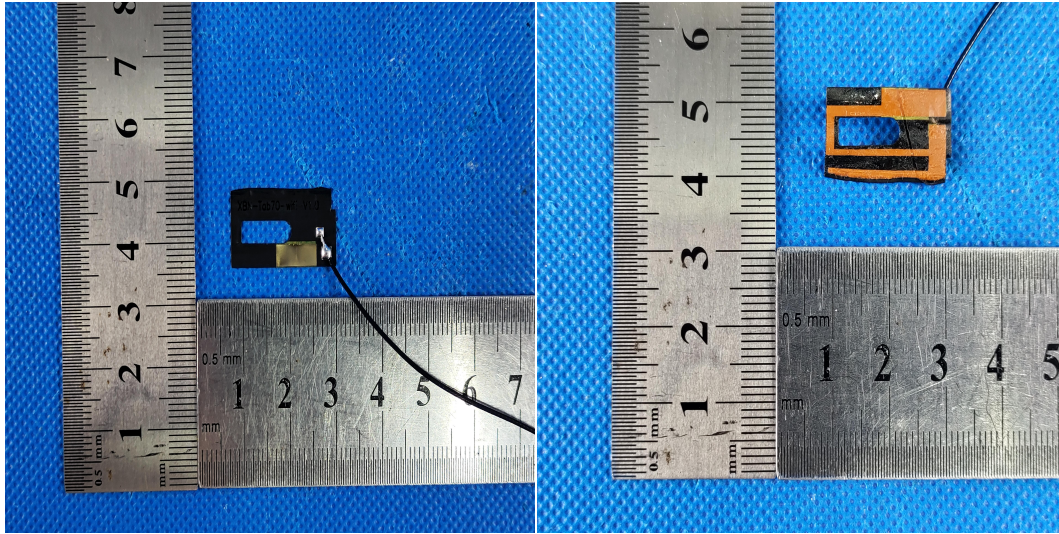

Main Antenna matching circuit:

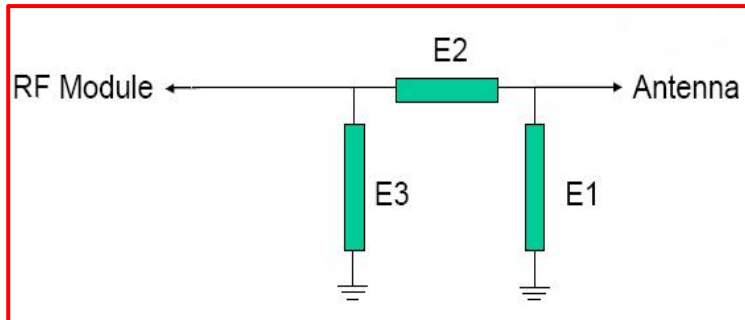

Wifi/BT antenna Log Mag/SWR/Smith:

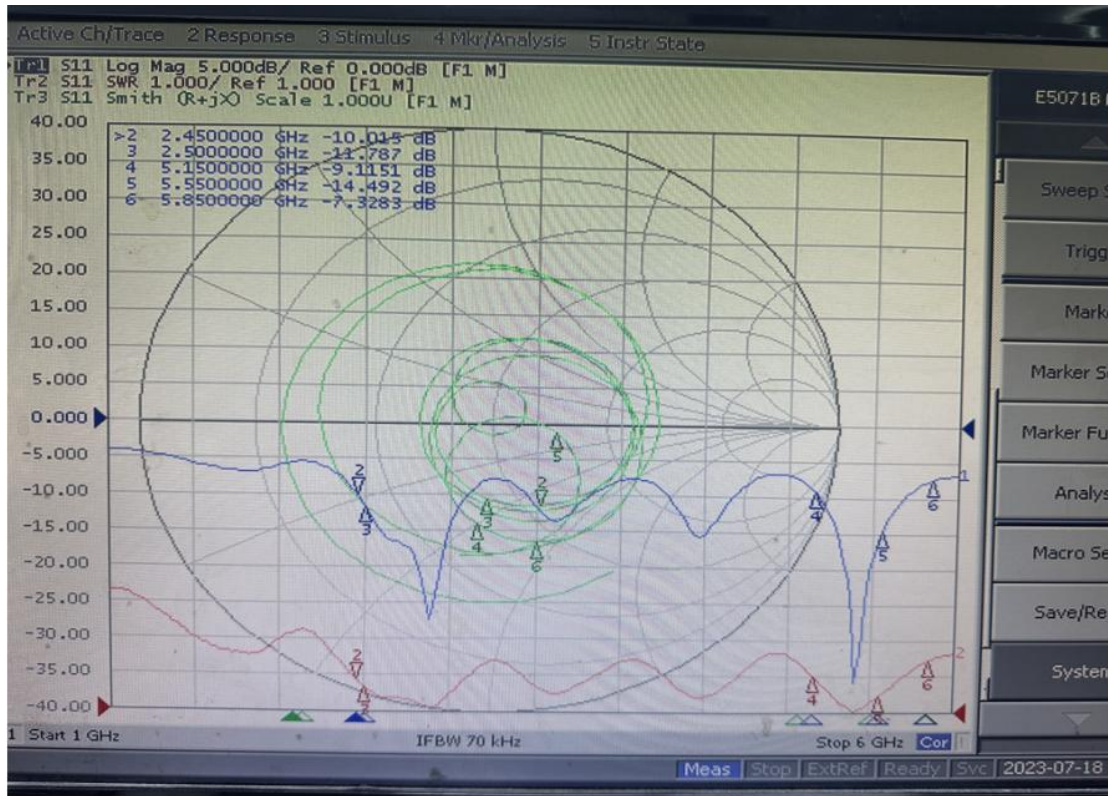

Antenna gain:

Frequency (MHZ)	Average Gain(dBi)	Peak Gain(dBi)
WIFI 2.4G/BT	-5.3	-3.3
WIFI 5.8G	-3.2	-1.7

Main antenna OTA:

WIFI OTA				
	Band	Channel	TRP	TIS
2.4G	b (11M)	1	18.6	
		6	18.27	
		13	18.75	-83.8
	g (54M)	1	16.5	
		6	16.25	
		13	16.83	-71.26
	n (MCS7)	1	16.31	
		6	16.54	
		13	16.66	-65.6

WIFI OTA				
	Band	Channel	TRP	TIS
5G	a (54M)	36	14.52	
		149	14.44	
		165	14.71	-71.35
	ac (MCS8)	36	12.82	
		149	12.86	
		165	12.58	-64.28
	ax (MCS8)	36	12.71	
		149	12.57	
		161	12.82	-65.33

Wifi 1 TRP

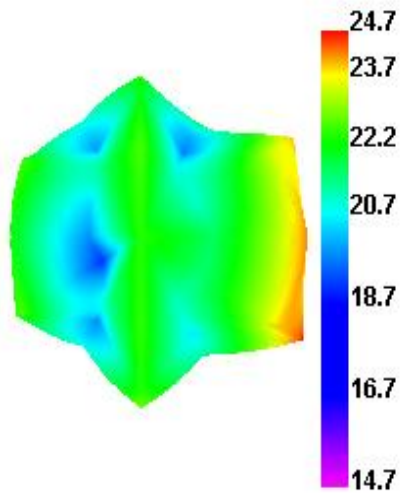

Wifi 1 TRP H

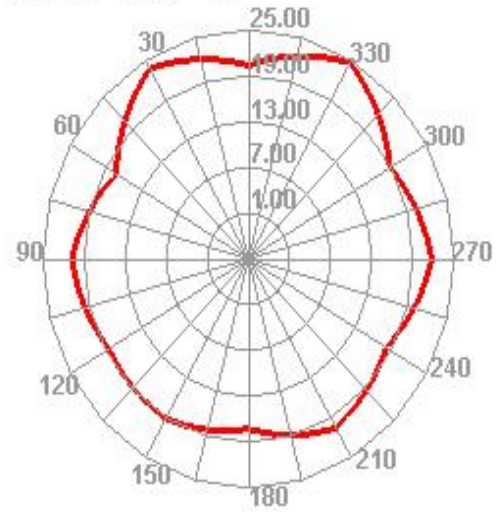

Wifi 6 TRP

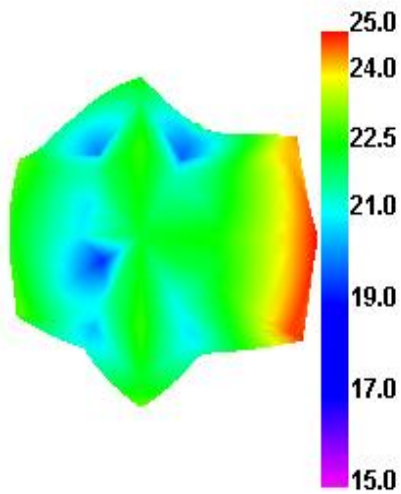

Wifi 6 TRP H

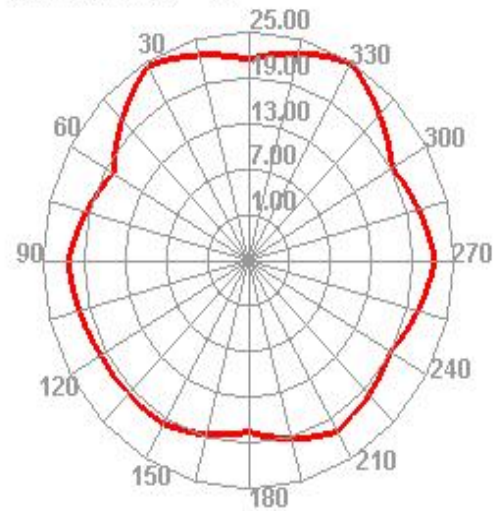

Wifi 13 TRP

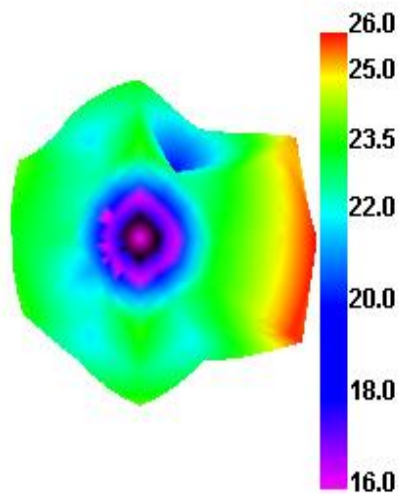

Wifi 13 TRP H

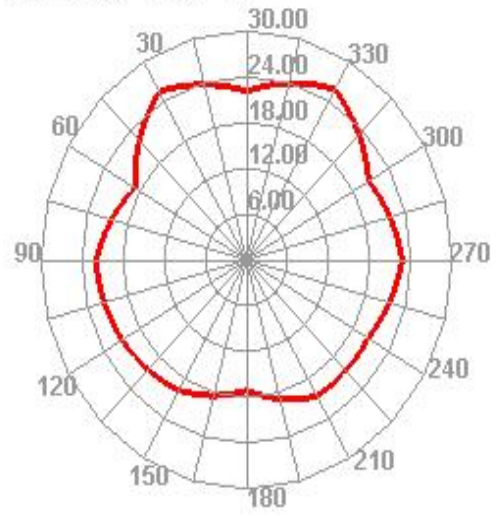

Wifi 36 TRP

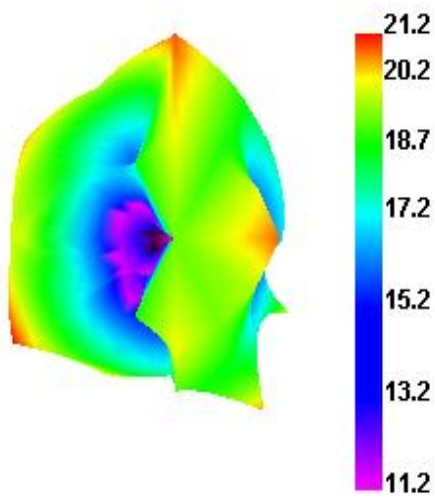

Wifi 36 TRP H

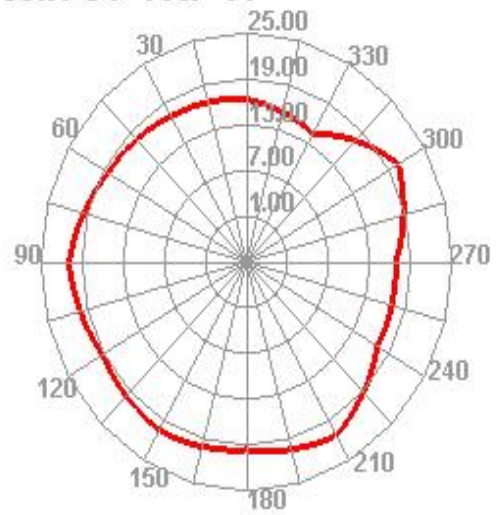

Wifi 149 TRP

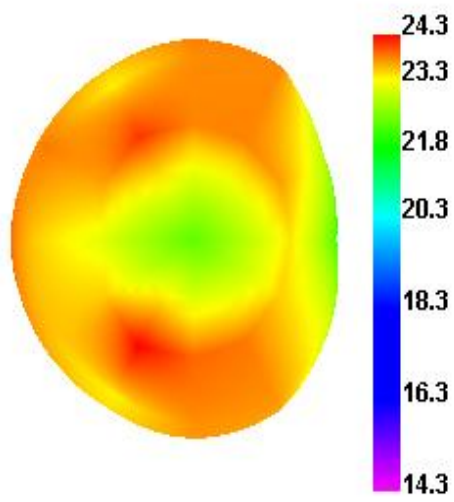

Wifi 149 TRP H

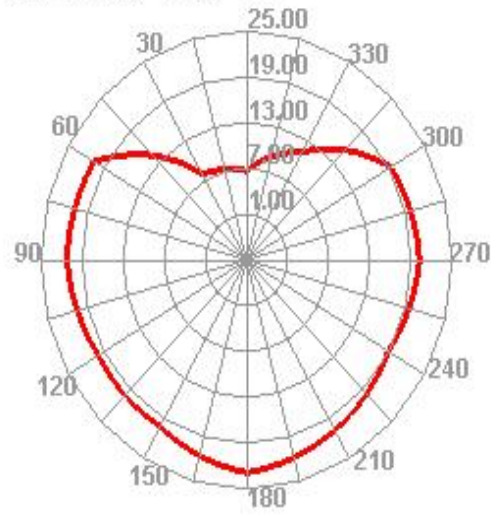

Wifi 165 TRP

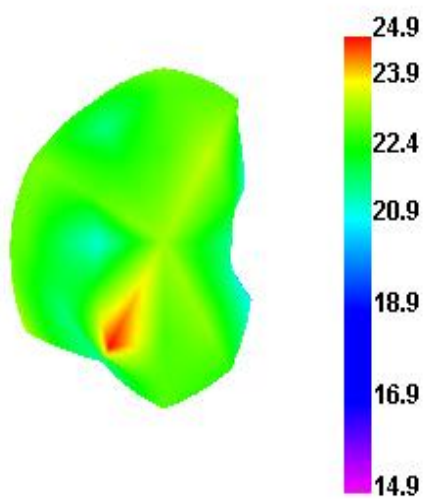

Wifi 165 TRP H

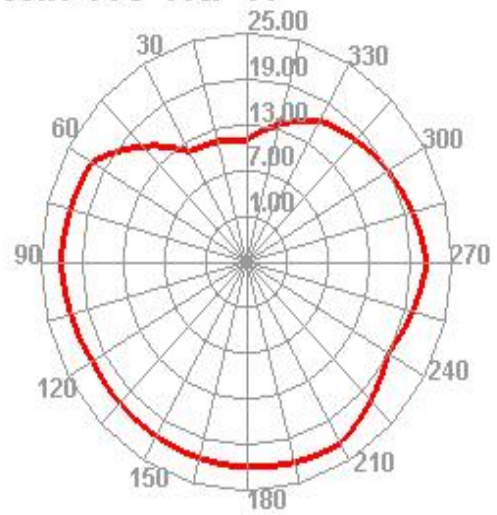

Environmental treatment

Environmental treatment: Left as it is, no changes

