

Customer: Duoke  
Project: TAB12Pro  
ME: Xiao Xiang-13316888409  
RF: Long Yaobin - 15874137313  
Date:January 31, 2023  
Report Type:  
Version No.: V4.0  
Status: T1  
Frequency band:  
GSM:B2/B3/B5/B8  
WCDMA:B1/B8  
FDD-LTE: B1/B3/B7/B8/B20  
TDD-LTE: B40  
GPS Satellite positioning antenna  
2.4G/5G WIFI  
BT

Passive main antenna LOG MAG:

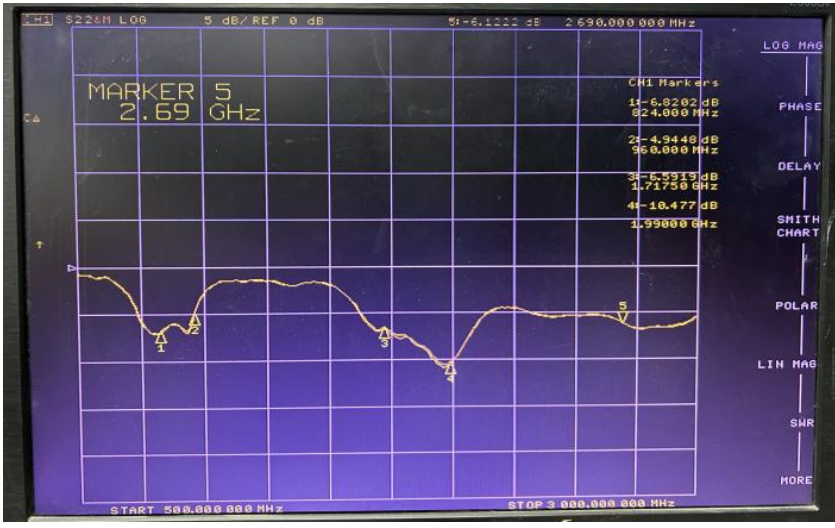

Passive main antenna SWR:



# GPS/Wifi/BT antenna LOG MAG:

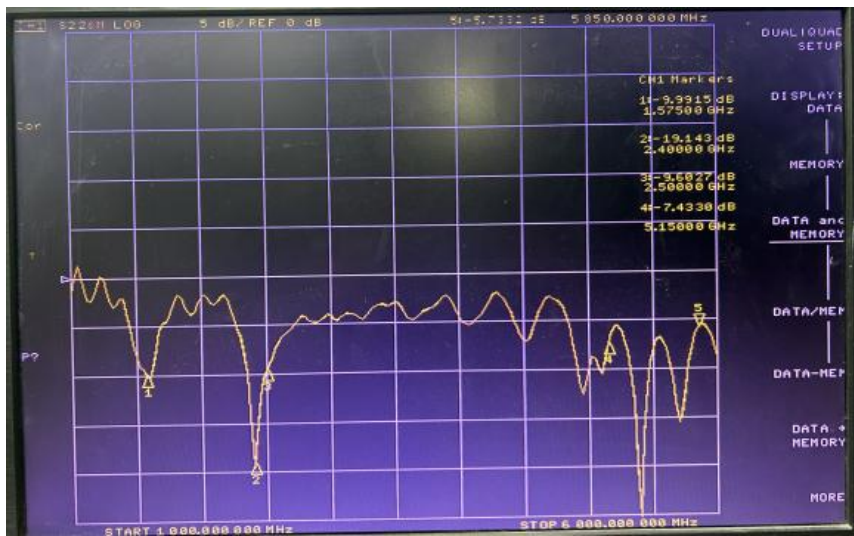

# GPS/Wifi/BT antenna SWR:



# Diversity antenna LOG MAG:



# Diversity antenna SWR:



## Antenna gain :

Frequency (MHZ)	Average Gain(dBi)	Peak Gain(dBi)
GSM850	-5.3	-2.6
GSM900	-6.1	-3.1
DCS1800	-4.4	1.2
PCS1900	-4.1	1.3
WCDMA B1	-3.9	1.5
WCDMA B8	-6.1	-3.1
LTE B1	-3.9	1.5
LTE B3	-4.1	1.2
LTE B7	-5.3	0.5
LTE B8	-6.1	-3.1
LTE B20	-5.3	-2.6
LTE B40	-5.6	0.7
GPS	-4.6	0.5
WIFI 2.4G/BT	-4.7	0.8
WIFI 5.8G(5150M)	-5.0	1.0
WIFI 5.8G(5850M)	-5.3	1.2

## Main antenna OTA:

Band	Channel	TRP	Dark TIS
GSM 850	128	27.5	-104.3
	190	27.9	-103.8
	251	28.2	-103.1
EGSM	1	26.6	-103.1
	62	26.7	-102.9
	124	26.5	-102.4
DCS	512	24.5	-105.7
	698	25.3	-103.7
	885	25.6	-102.4
PCS	512	25.8	-104.3
	661	25.6	-104.2
	810	25.5	-105.1
WCDMA Band1	10562	18.9	
	10700	18.7	
	10838	18.8	-106.2
WCDMA Band8	2937	17.2	
	3013	16.7	
	3088	16.1	-106.3

Main antenna OTA:

	Band	Channel	TRP	Dark TIS
FDD-LTE (10M)	B1	50	19.2	
		300	18.8	
		550	18.5	-93.3
	B3	1250	18.8	
		1575	18.6	
		1900	18.7	-94.2
	B7	2800	17.4	
		3100	16.8	
		3400	17.9	-92.5
	B8	3500	17.2	
		3625	16.9	
		3750	16.5	-90.3
	B20	6200	17.1	
		6300	17.3	
		6400	17.1	-90.1

Band		Channel	TRP	Dark TIS
TDD-LTE (20M)	B40	38750	18.7	
		39150	17.2	
		39550	16.8	-91.6



WIFI OTA				
	Band	Channel	TRP	TIS
2.4G	b (11M)	1	12.3	
		6	11.8	
		13	11.7	-81.2
	g (54M)	1	11.7	
		6	11.6	
		13	11.3	-71.6
	n (MCS7)	1	11.7	
		6	11.2	
		13	10.9	-66.2
5G	a (54M)	36	11.5	
		56	10.6	
		165	11.1	-71.5
	n (MCS7)	36	11.4	
		56	10.8	
		165	11.2	-67.1



## GPS Test:

**Measured site: Ping'an Rd**

**Weather: Sunny**

**Max S/N : 43**

**Stars: 26**

**Positioning time: 50s**

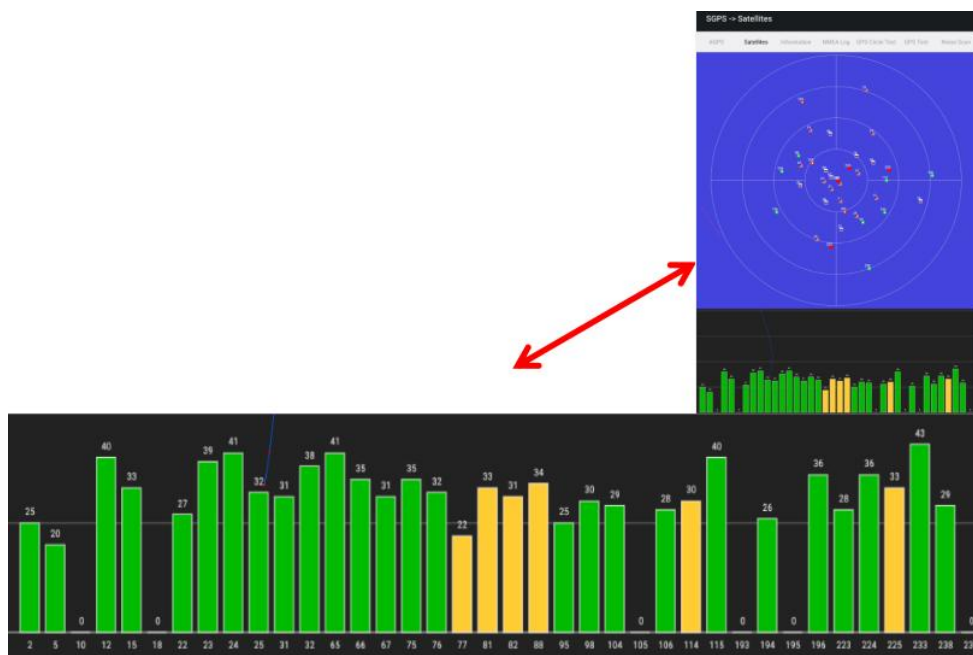

**690.000MHz**

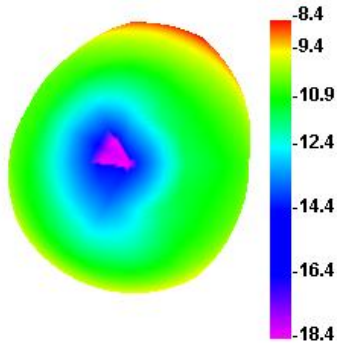

**690.000MHz H**

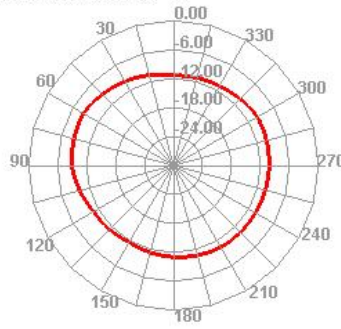

**690.000MHz E1**

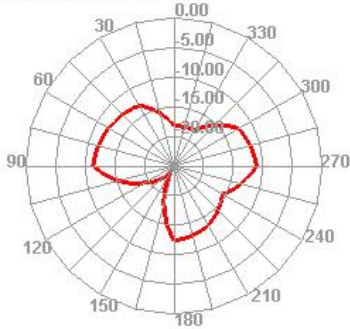

**690.000MHz E2**

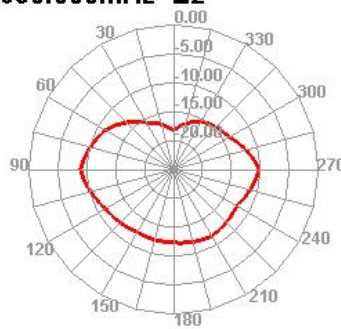

**700.000MHz**

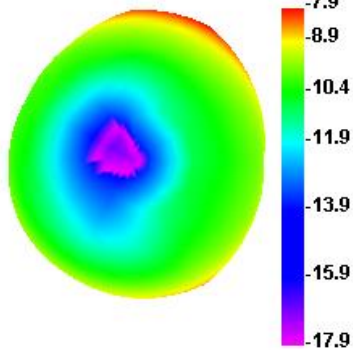

**700.000MHz H**

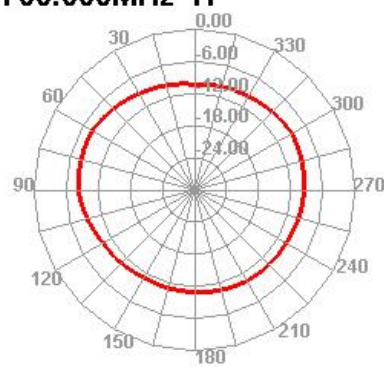

**700.000MHz E1**

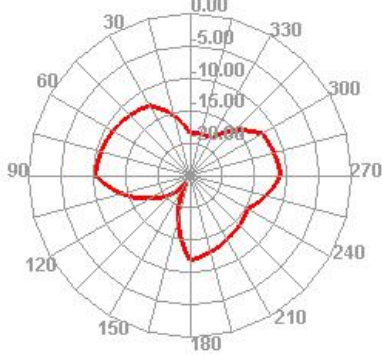

**700.000MHz E2**

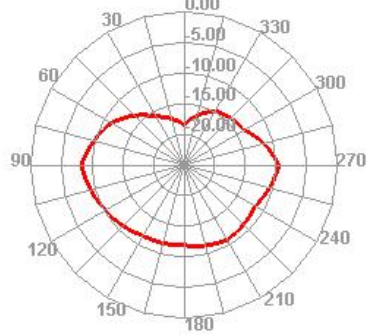

**1690.000MHz**

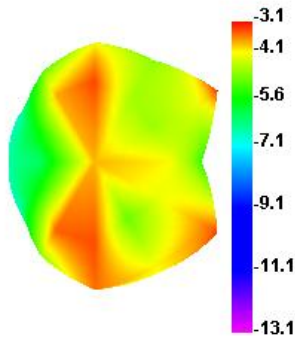

**1690.000MHz H**

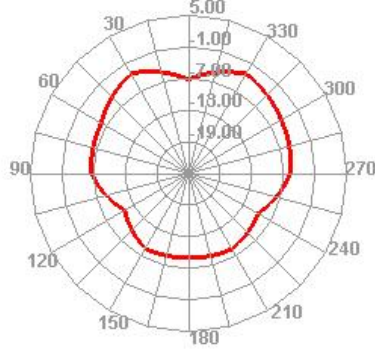

**1690.000MHz E1**

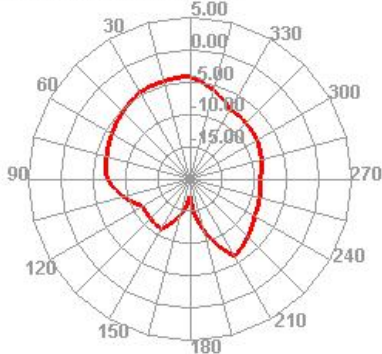

**1690.000MHz E2**

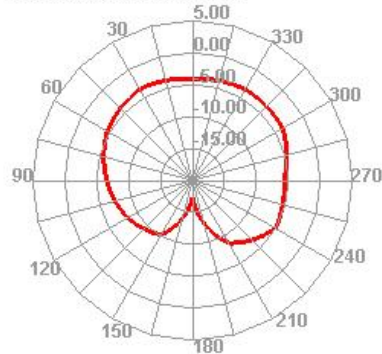

1500.000MHz

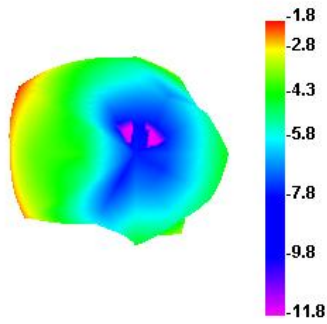

1500.000MHz H

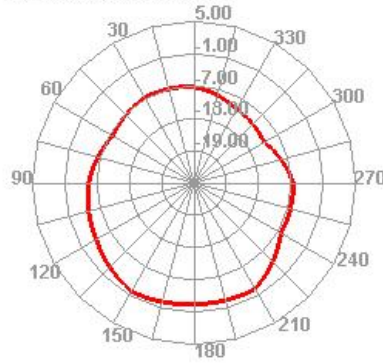

1500.000MHz E1

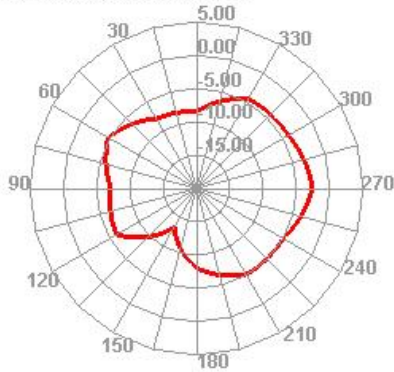

1500.000MHz E2

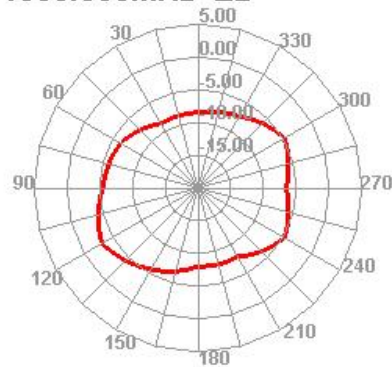

1510.000MHz

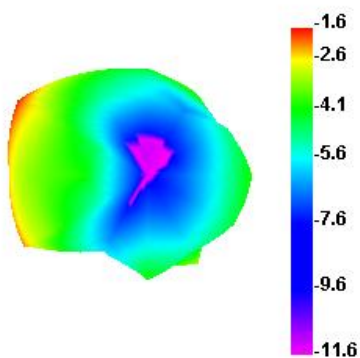

1510.000MHz H

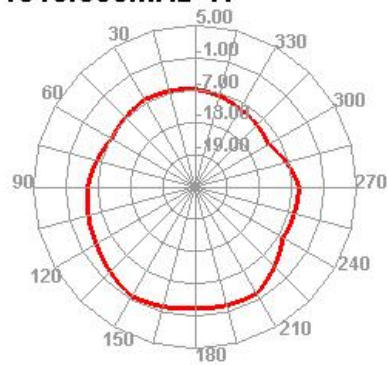

**1510.000MHz E1**

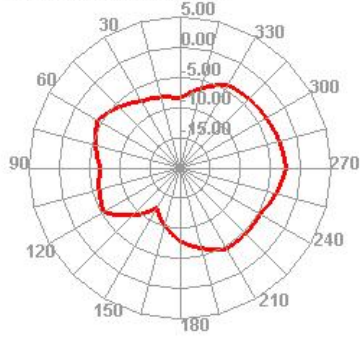

**1510.000MHz E2**

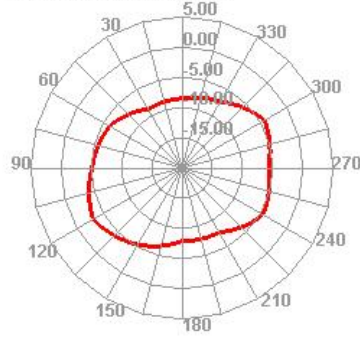

**2410.000MHz**

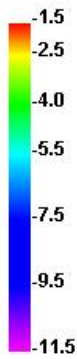
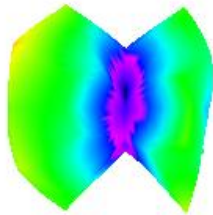

**2410.000MHz H**

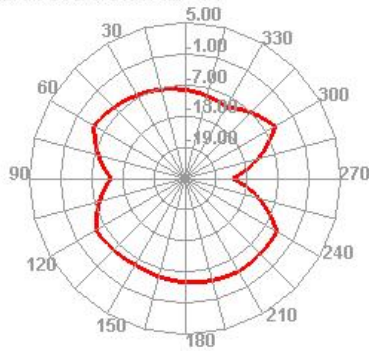

**2410.000MHz E1**

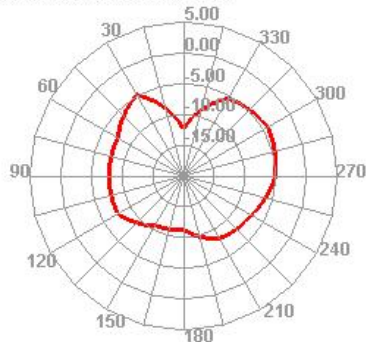

**2410.000MHz E2**

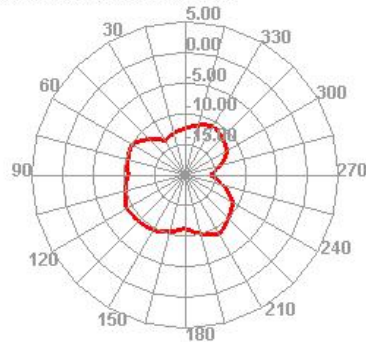



**2420.000MHz**

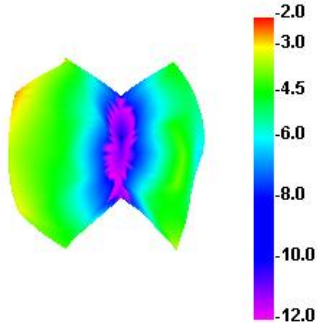

**2420.000MHz H**

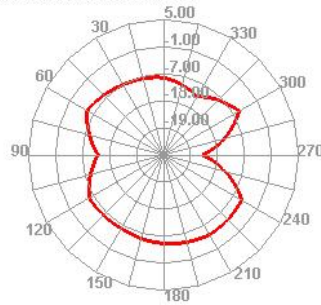

**2420.000MHz E1**

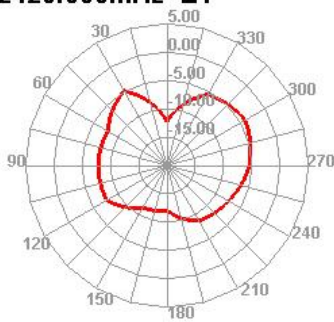

**2420.000MHz E2**

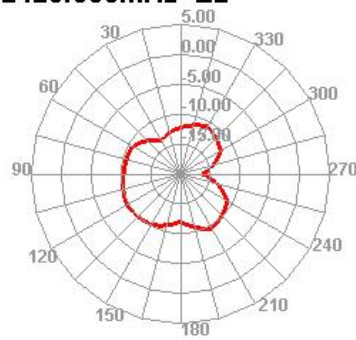

**5100.000MHz**

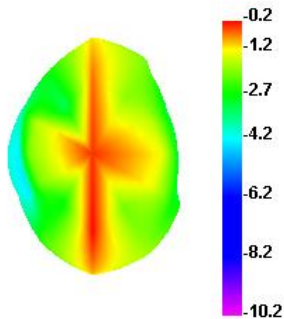

**5100.000MHz H**

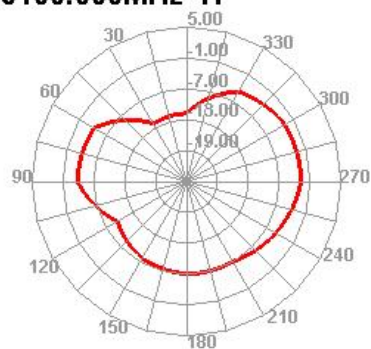

**5100.000MHz E1**

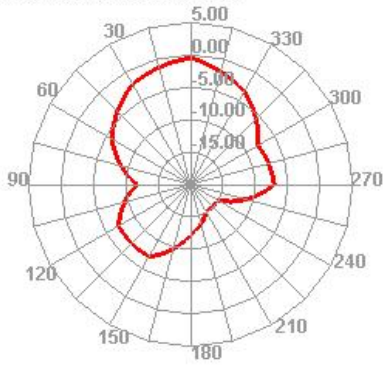

**5100.000MHz E2**

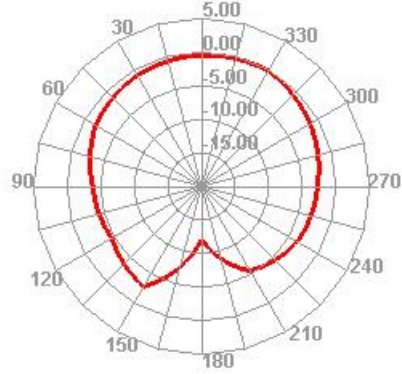

**5300.000MHz**

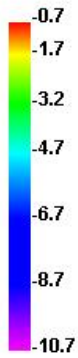
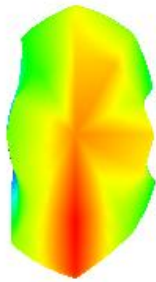

**5300.000MHz H**

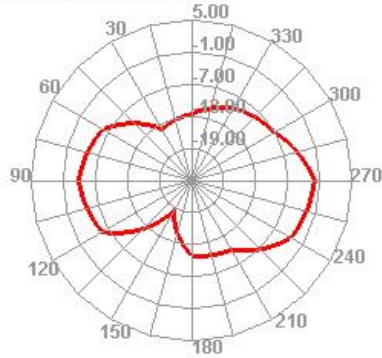

**5300.000MHz E1**

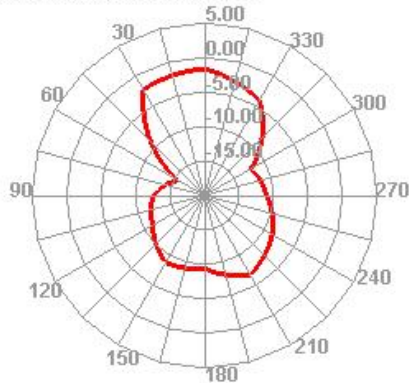

**5300.000MHz E2**

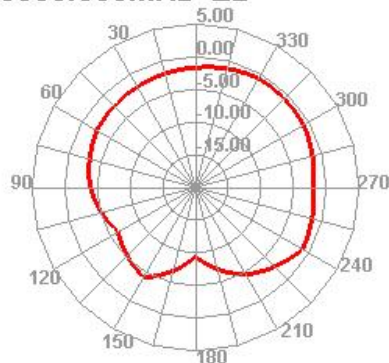



## Environmental treatment

As shown in the figure, a 1mm high conductive sponge is pasted at the copper exposed part on the back of the main board in the red box to fully ground the main board and the laser engraving part of the bottom shell.

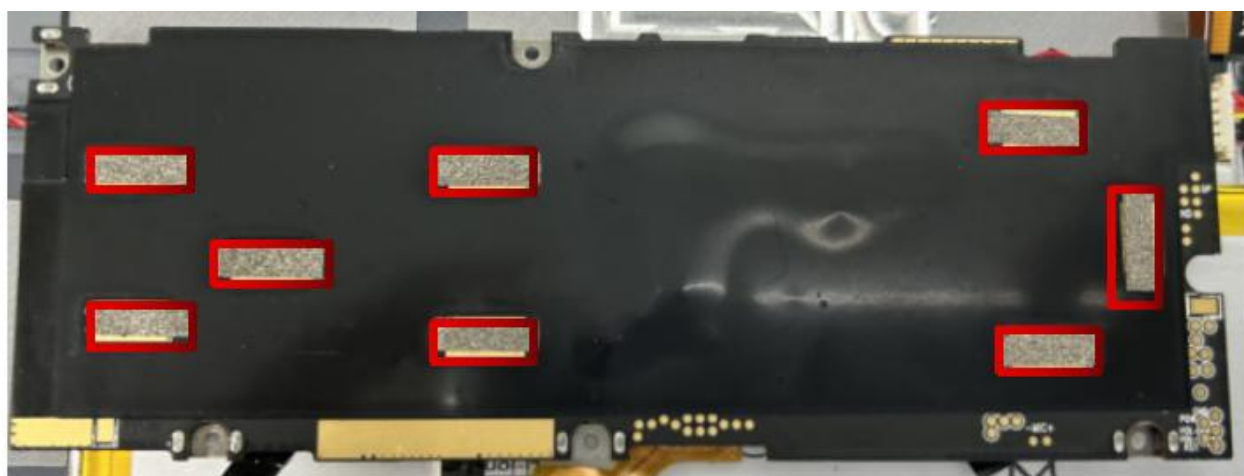

As shown in the figure, graphite copper shielded screen flat wire and screen IC are pasted in the red box.



As shown in the figure: conductive sponge is pasted in the red box and the screen metal is grounded.

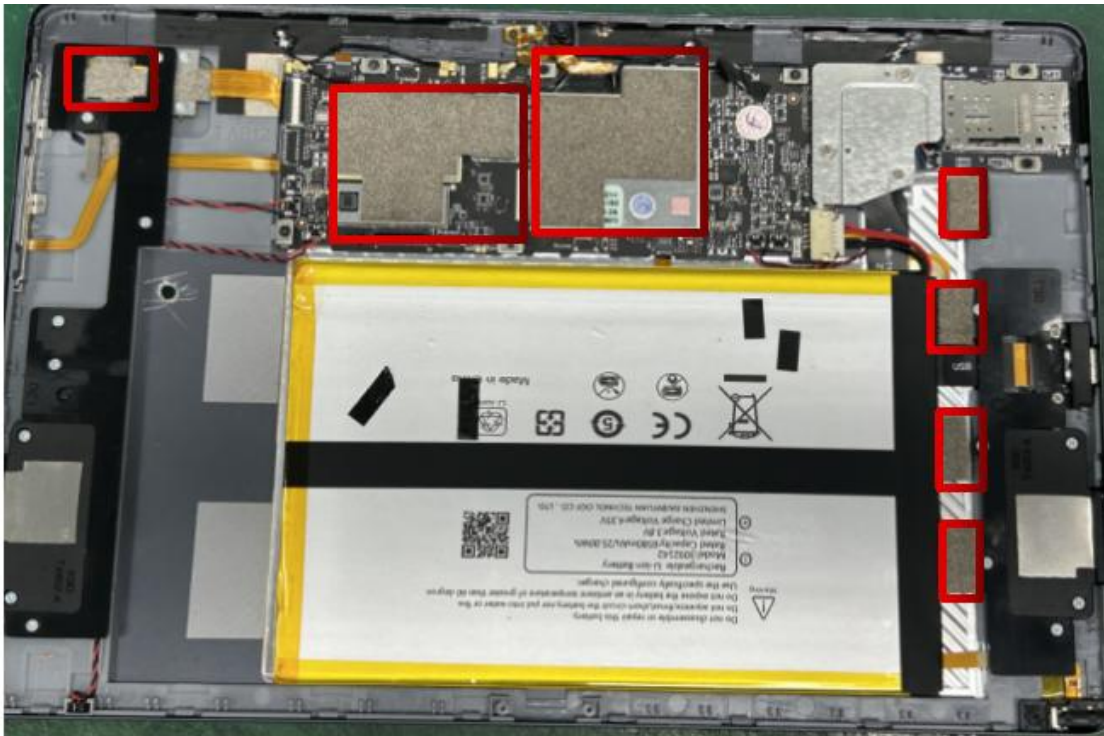

As shown in the figure, the diversity antenna in the red frame pulls the conductive cloth and extends it to the ground at the radium carving below the SIM card slot.

A conductive sponge is pasted above the radium sculpture in the green box to ground the SIM card slot and the bottom shell.

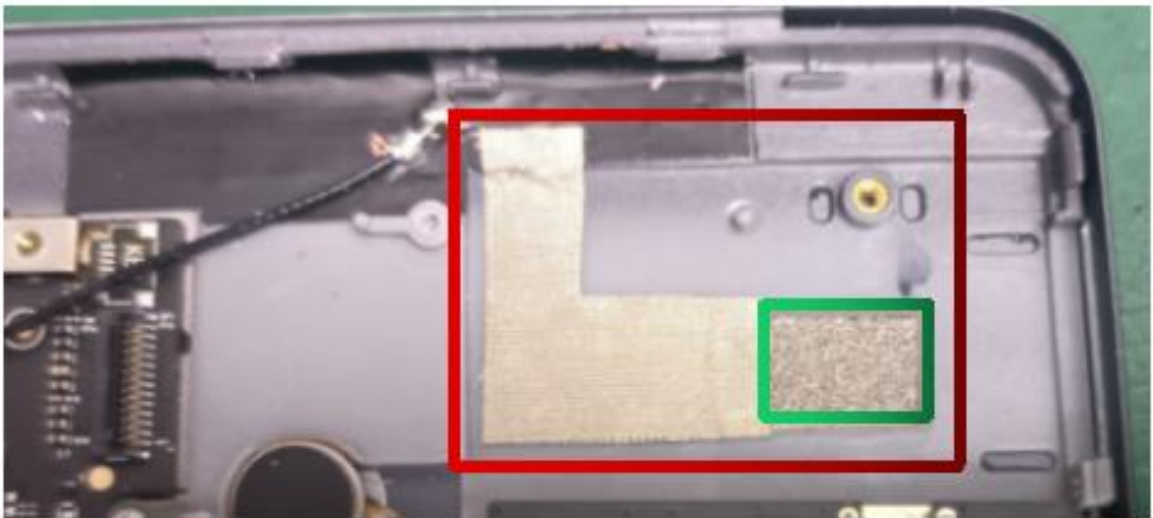

As shown in the figure, the copper exposed part of the main antenna and the three and one antenna shall be pasted with conductive cloth and extended to the radium carving part of the bottom shell for grounding.



As shown in the figure: paste conductive sponge to shield the rear camera.



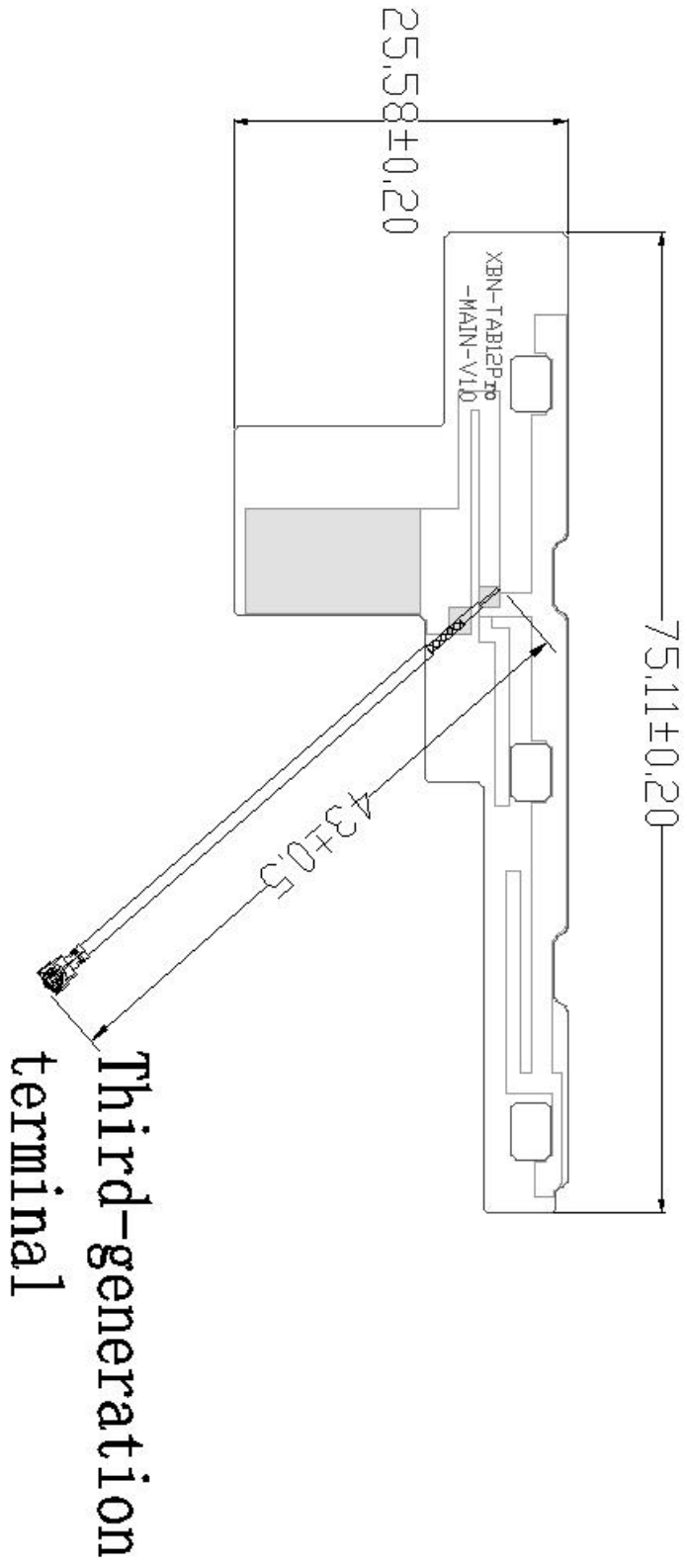



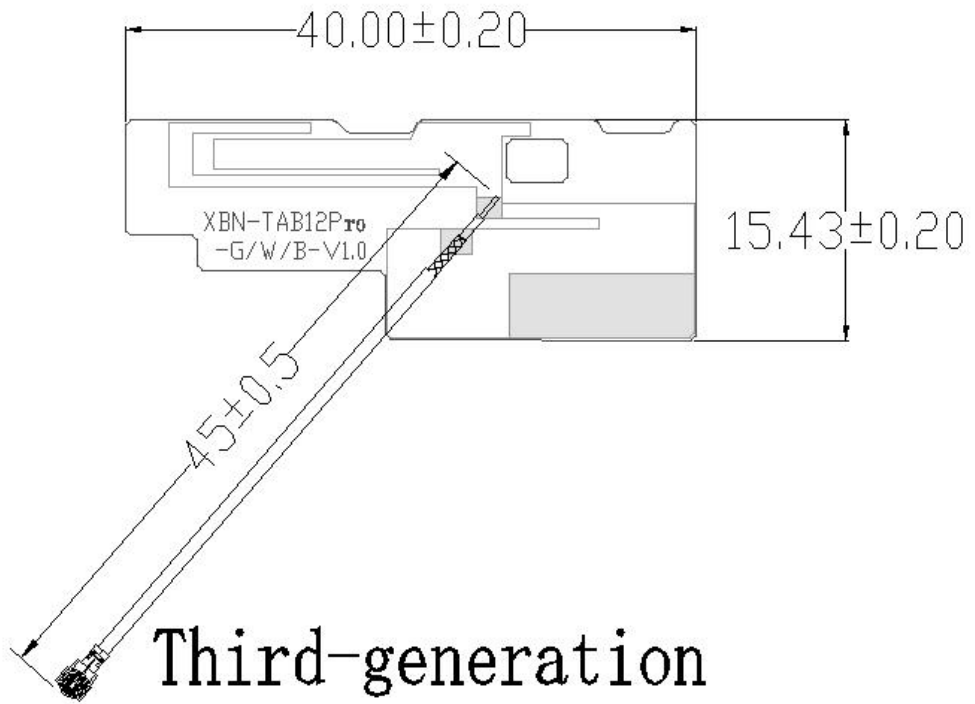

Third-generation  
terminal

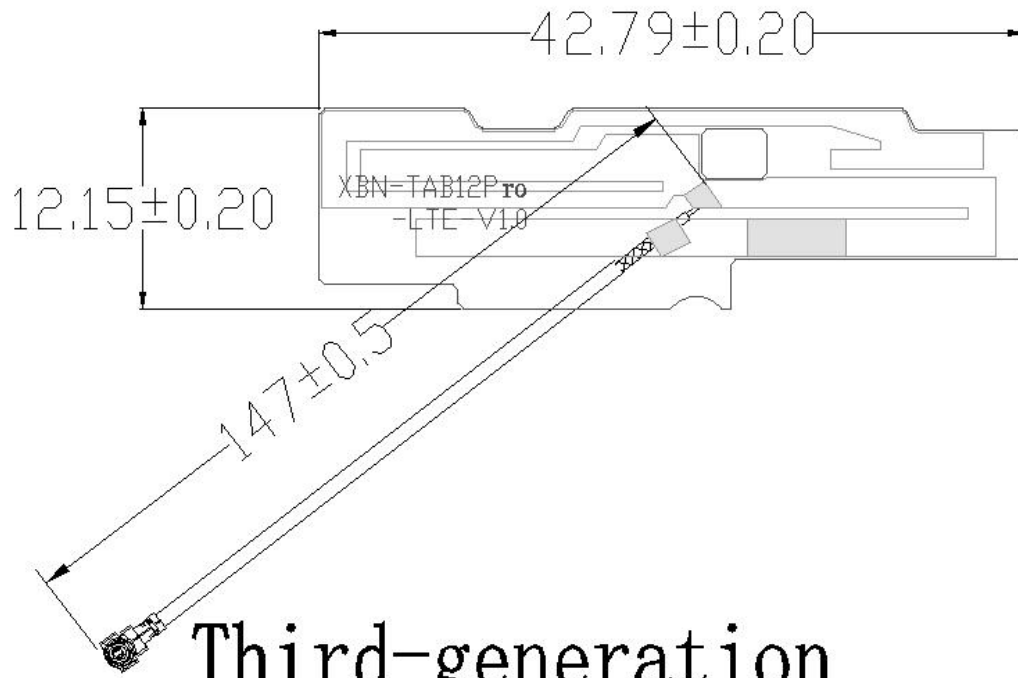

## Third-generation terminal