

Customer: Duoke
 Project: MP80
 ME: Xiang Xiao-13316888409
 RF: HouXiongLiu - 17328763286
 Date: September twenty-two, 2023
 Report Type:
 Version No.: V1.0
 Status: T2
 Frequency band:
 2.4G/5.8G WIFI
 BT
 Main Antenna matching circuit:

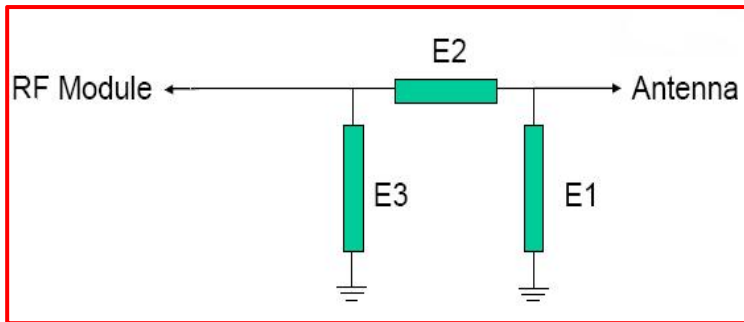

0201 Specifications		
Element	Value	Tag No
E1 (0201)	No change	
E2 (0201)		
E3 (0201)		

Wifi/BT antenna Log Mag/SWR/Smith:

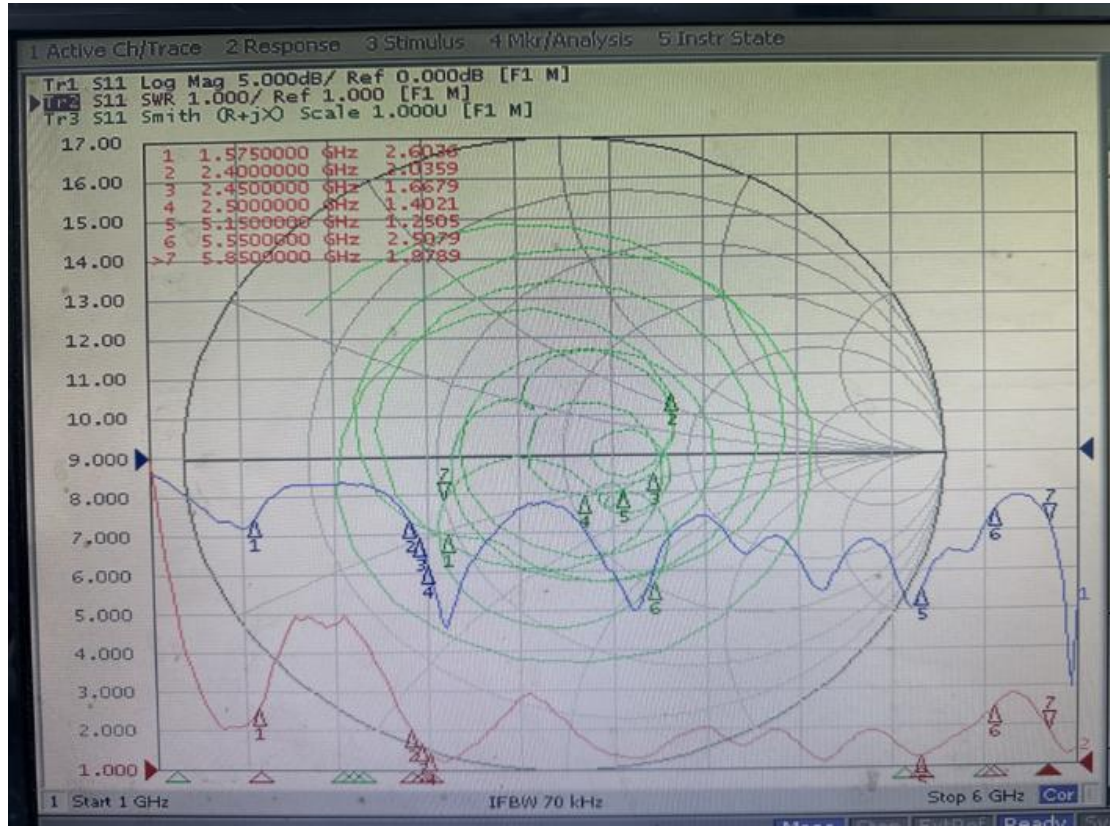

Antenna gain:

Frequency (MHz)	Average Gain(dBi)	Peak Gain(dBi)
WIFI 2.4G/BT	-5.5	-3.6
WIFI 5.8G	-3.4	-1.8

Wifi 1 TRP

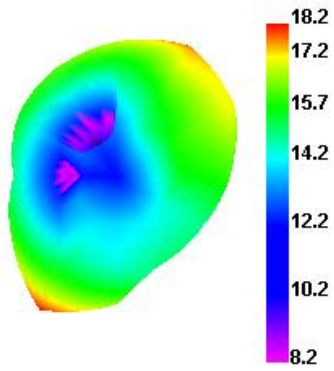

Wifi 1 TRP H

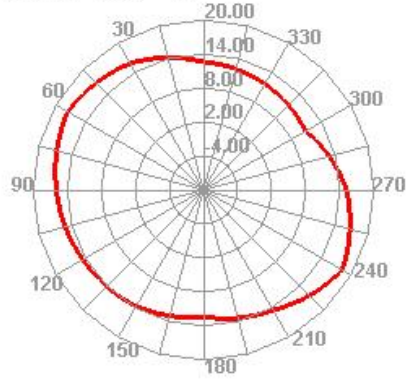

Wifi 13 TRP

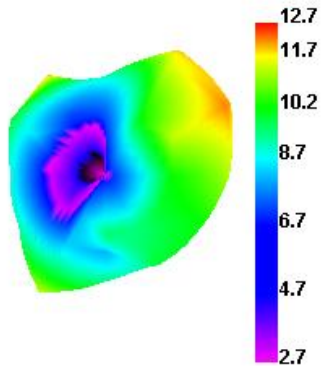

Wifi 13 TRP H

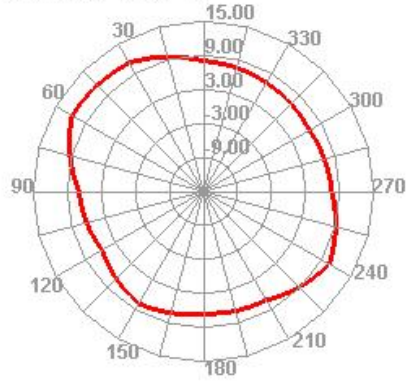

Wifi 13 TIS

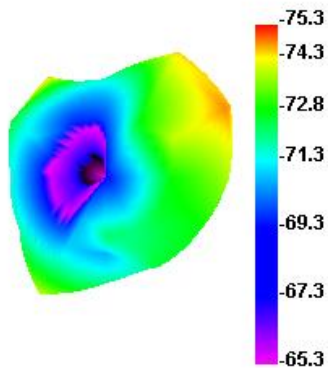

Wifi 13 TIS H

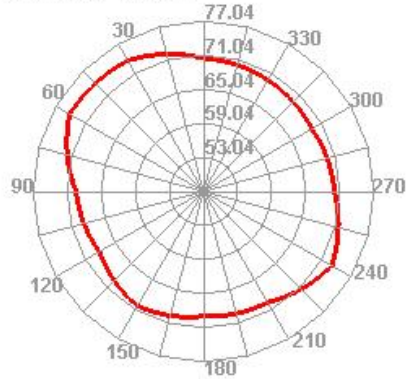

Wifi 36 TRP

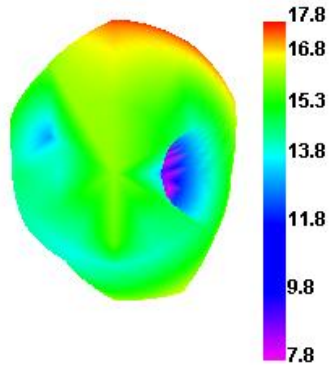

Wifi 36 TRP H

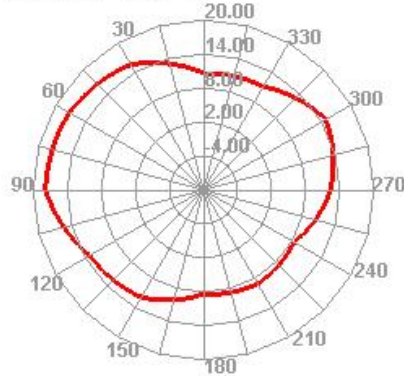

Wifi 165 TRP

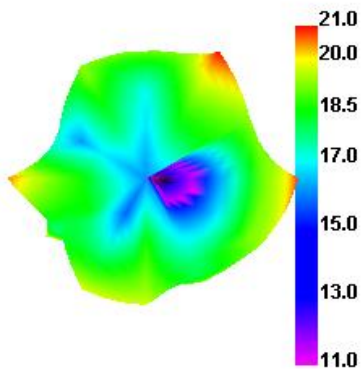

Wifi 165 TRP H

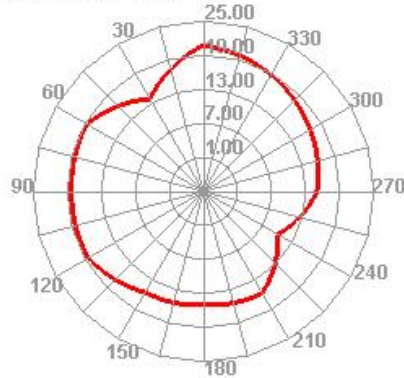

Wifi 165 TIS

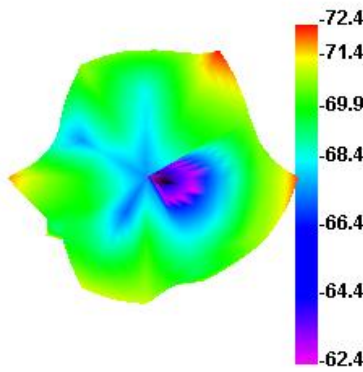

Wifi 165 TIS H

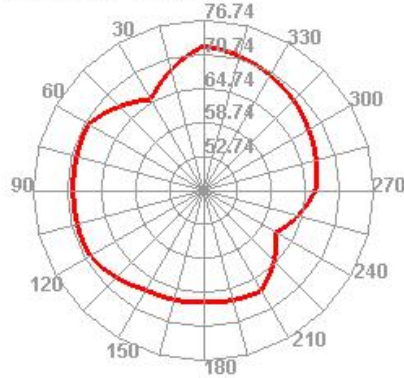

Product specification drawing

