



MP200- Antenna Test Report

Date: 2023.09.25

CONTENTS

01

Project Overview

02

Test Environment

03

Matching Circuit

04

Environmental
Treatment

05

Passive Report

06

Active Report

07

Conclusion

Main antenna design spectrum:	WIFI 2.4/5.8G
Type of antenna:	PIFA
DIV antenna design spectrum:	WIFI 2.4/5.8G
Type of antenna:	PIFA

Repor version:	Date	Content
V3.0	2023.09.25	Antenna test report

Test Environment

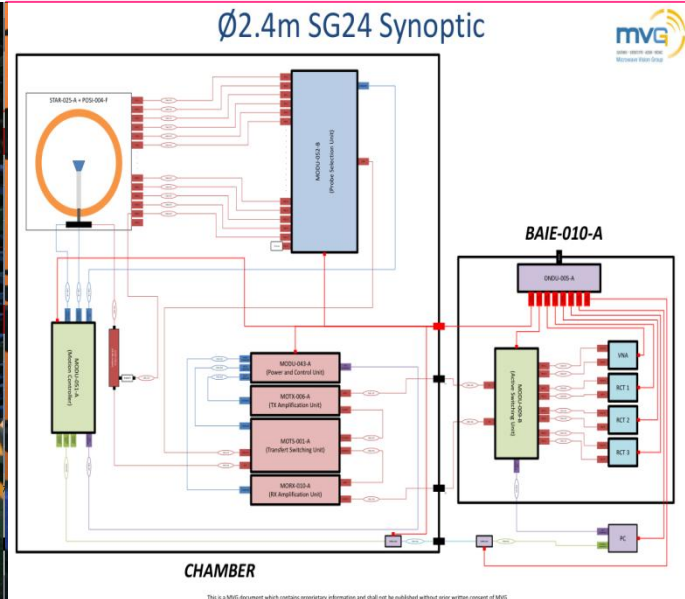
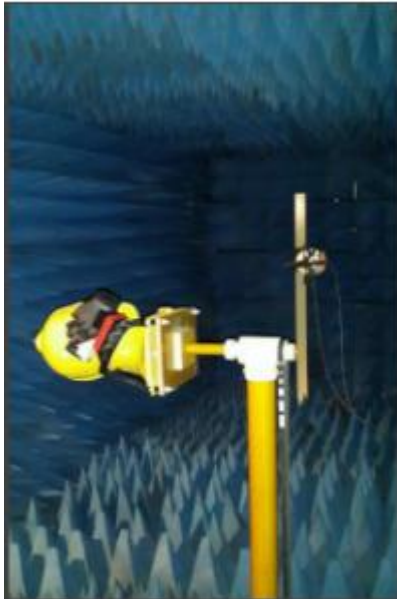
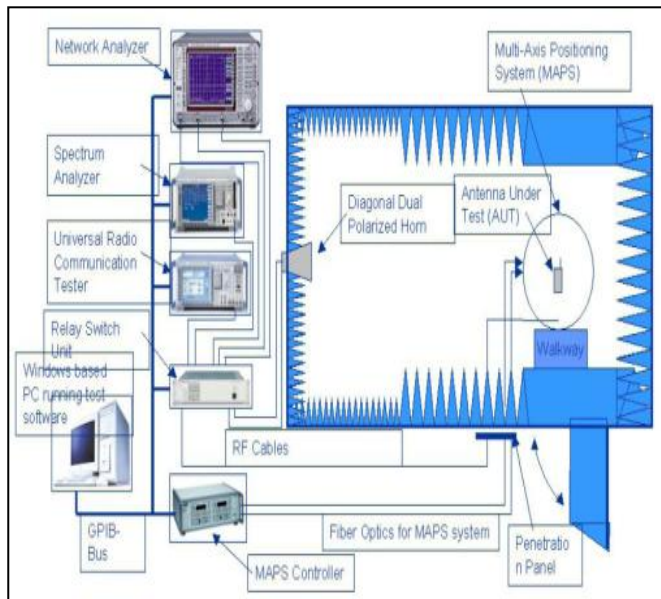

Darkroom system : MVG SG24LT (Satmio)

Matching Circuit

main antenna design	
Element	Value
E1(0201):	/
E2(0201):	/
E3(0201):	/

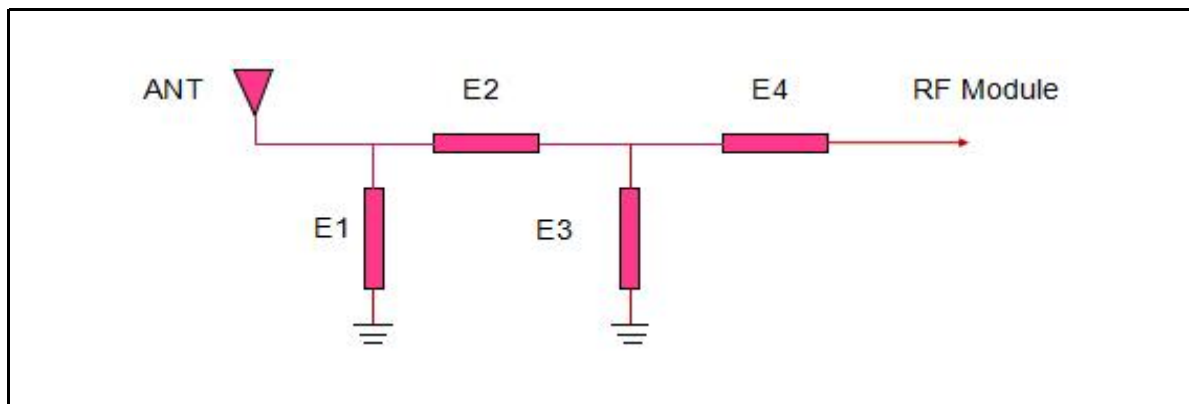

Note: The matching circuit has not changed.





WiFi passive Efficiency, Gain

1号天线

Frequency	Efficiency	Efficiency .	Gain . dB
2400000000.00	55.08%	-2.59022	3.701189023
2410000000.00	54.55%	-2.63195	3.74311413
2420000000.00	54.33%	-2.64973	3.672063619
2430000000.00	56.38%	-2.48912	3.585343214
2440000000.00	56.30%	-2.49497	3.349225943
2450000000.00	55.71%	-2.54055	3.310386285
2460000000.00	56.33%	-2.49275	3.287989885
2470000000.00	56.97%	-2.44342	3.101078981
2480000000.00	55.62%	-2.54763	2.795332023
2490000000.00	55.06%	-2.59147	2.730892477
2500000000.00	56.34%	-2.49167	2.712537385

Frequency	Efficiency	Efficiency .	Gain . dB
5200000000.00	52.47%	-2.8005	5.343559887
5230000000.00	49.86%	-3.02227	5.155517426
5260000000.00	49.89%	-3.01991	5.243731993
5290000000.00	47.78%	-3.20768	4.785772215
5320000000.00	43.75%	-3.5901	4.026464455
5350000000.00	37.30%	-4.28343	3.165253275
5380000000.00	37.72%	-4.23389	3.131756057
5410000000.00	42.83%	-3.68286	3.986118929
5440000000.00	48.47%	-3.14525	4.74733351
5470000000.00	48.55%	-3.13797	5.023175766
5500000000.00	51.50%	-2.8818	5.530836481
5530000000.00	55.84%	-2.53033	6.321790937
5560000000.00	52.69%	-2.78271	6.072142447
5590000000.00	45.85%	-3.38642	5.625156432
5620000000.00	42.18%	-3.74923	5.412221183
5650000000.00	39.53%	-4.03074	5.212939217
5680000000.00	39.45%	-4.03954	5.344841251
5710000000.00	38.67%	-4.12655	5.334743363
5740000000.00	41.27%	-3.84339	5.810107147
5770000000.00	46.75%	-3.30228	6.360019409
5800000000.00	47.34%	-3.24804	6.429546501

Measuring instrument : Agilent Technologies E5071B 300kHz-8.5GHz ENA Series Network Analyzer Darkroom system : MVG SG24LT (Satmio)

2.4G Passive pattern

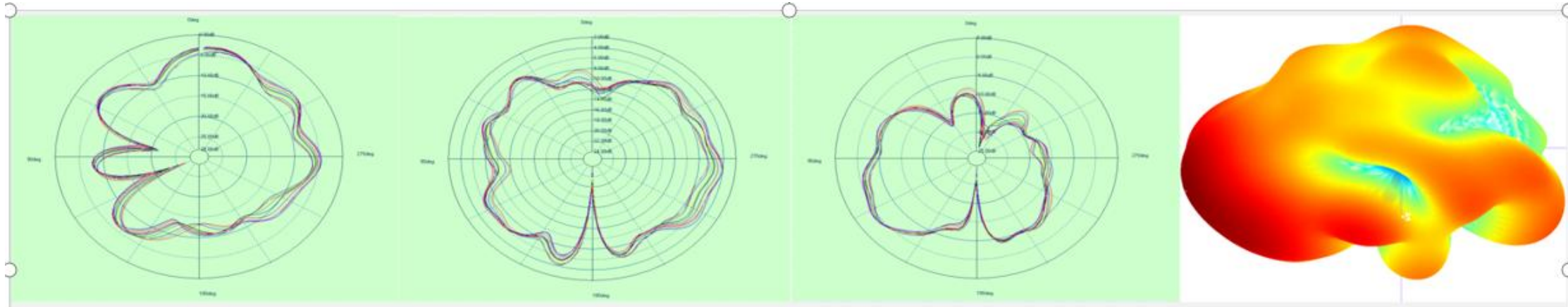

5.8G Passive pattern

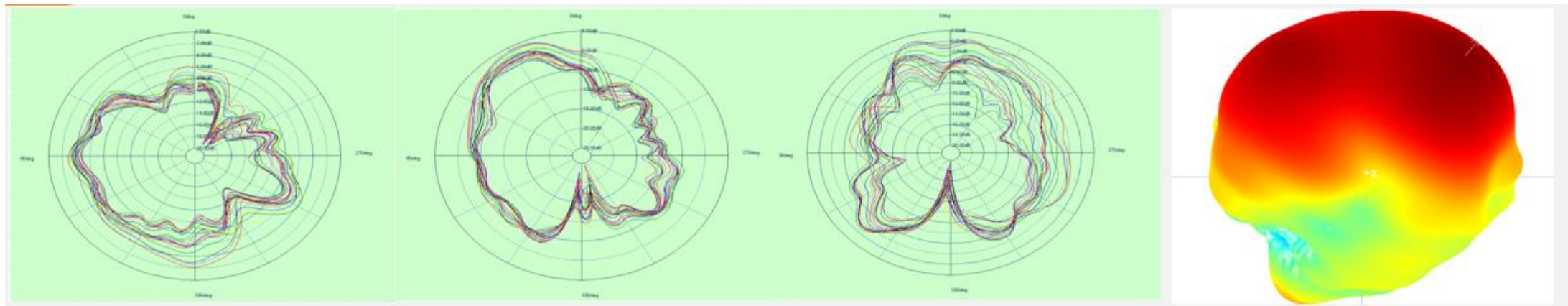

Measuring instrument : Agilent Technologies E5071B 300kHz-8.5GHz ENA Series Network Analyzer Darkroom system : MVG SG24LT (Satmio)



WiFi passive Efficiency, Gain

2号天线

Frequency	Efficiency	Efficiency .	Gain . dB
2400000000.00	57.43%	-2.40826	3.616561319
2410000000.00	56.90%	-2.44874	3.768177066
2420000000.00	55.01%	-2.59551	3.53659558
2430000000.00	55.38%	-2.56638	3.273808795
2440000000.00	56.02%	-2.51656	3.257936624
2450000000.00	55.80%	-2.53397	3.383116239
2460000000.00	55.90%	-2.52627	3.182061025
2470000000.00	56.66%	-2.46689	3.152751291
2480000000.00	56.71%	-2.46304	3.36672354
2490000000.00	56.74%	-2.46145	3.572887502
2500000000.00	57.85%	-2.37695	3.745909251

Frequency	Efficiency	Efficiency .	Gain . dB
5200000000.00	61.62%	-2.10246	7.07052994
5230000000.00	58.58%	-2.32215	7.109344217
5260000000.00	56.52%	-2.4782	7.080105884
5290000000.00	53.24%	-2.73729	6.752134154
5320000000.00	48.34%	-3.15669	6.339143117
5350000000.00	40.18%	-3.95972	5.337176538
5380000000.00	40.78%	-3.89504	5.091665546
5410000000.00	46.16%	-3.35762	5.420534292
5440000000.00	50.82%	-2.94	5.726135453
5470000000.00	50.44%	-2.97228	5.693139529
5500000000.00	51.97%	-2.84232	5.869631465
5530000000.00	54.72%	-2.61892	6.489951054
5560000000.00	51.51%	-2.88089	6.206881775
5590000000.00	44.17%	-3.54908	5.548423322
5620000000.00	40.25%	-3.95209	5.104566799
5650000000.00	37.87%	-4.21683	4.713389307
5680000000.00	37.69%	-4.23798	4.242695458
5710000000.00	36.66%	-4.35771	4.253296203
5740000000.00	38.97%	-4.09216	4.744857054
5770000000.00	44.00%	-3.56586	5.233313811
5800000000.00	45.53%	-3.41735	5.219871191

Measuring instrument : Agilent Technologies E5071B 300kHz-8.5GHz ENA Series Network Analyzer Darkroom system : MVG SG24LT (Satmio)

2.4G Passive pattern

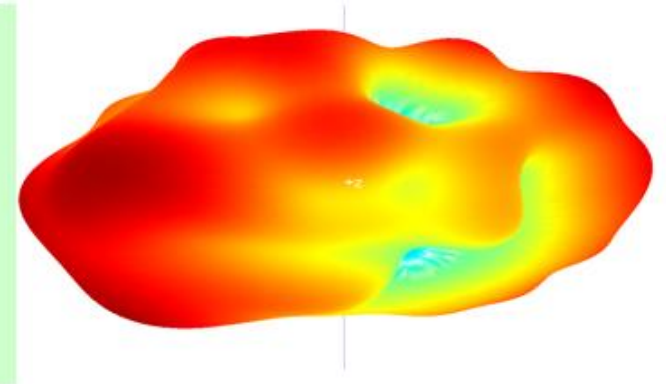
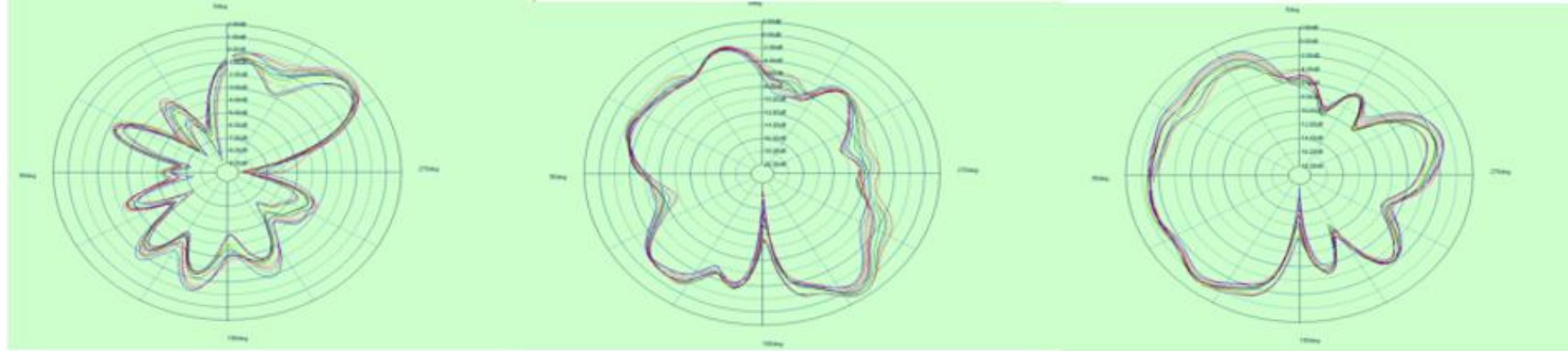

5.8G Passive pattern

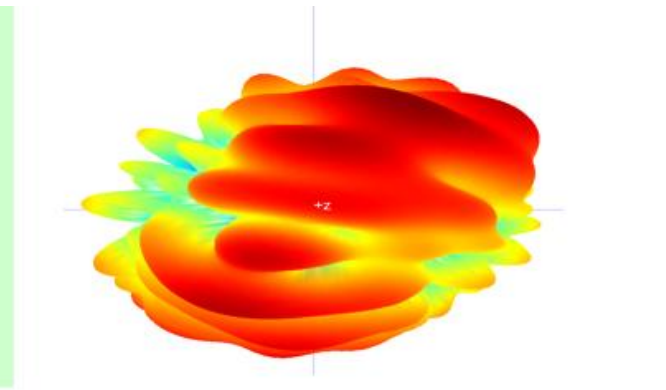
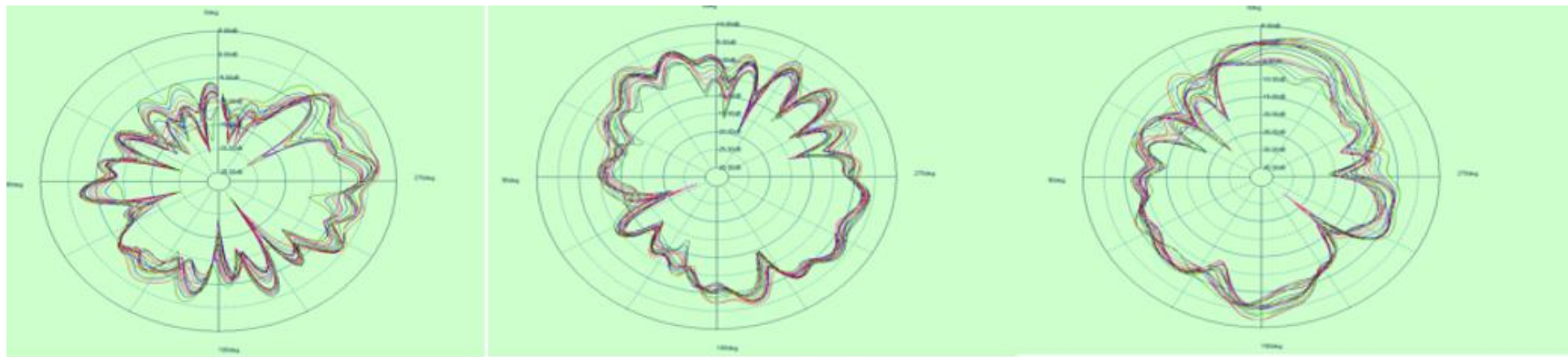

Measuring instrument : Agilent Technologies E5071B 300kHz-8.5GHz ENA Series Network Analyzer Darkroom system : MVG SG24LT (Satmio)



	BAND	2.4G-WIFI-B			2.4G-WIFI-G			
自由空间	CHANNAL	1	6	11	1	6	11	
	TRP	13.22	13.34	13.15	12.33	12.45	13.22	
	TIS	/	/	-81.48	/	/	-72.86	
	BAND	2.4G-WIFI-N			5.8G-WIFI-A			
	CHANNAL	1	6	11	36	149	165	
	TRP	11.89	11.67	12.12	12.44	12.66	12.57	
	TIS	/	/	-65.64	/	/	-72.43	
	BAND	5.8G-WIFI-AC			5.8G-WIFI-AX			
	CHANNAL	36	149	165	36	149	165	
	TRP	12.33	12.5	12.88	11.66	11.7	11.64	
	TIS	/	/	-67.56	/	/	-66.55	
	备注：3D数据							

1. This report is the sample antenna test results .
2. If you have any questions, please call.

THANK YOU

If you have any questions, please contact us
Daily service hours : Monday to Saturday 9:00-18:00
Switchboard Hotline : 0755-36615535 Fax: 0755-82916227
 website : www.mayaant.com

Confidentiality requirements

Shenzhen Maya communication equipment Co., Ltd. has owned the information provided by the proprietary technology and is not allowed to disclose it to any person or company without the prior written consent of Shenzhen Maya communication equipment Co., Ltd.