

# SMD CERAMIC ANTENNA

## Data Sheet

---

---

# CS-2450-16-C

For 2400-2483MHz

1.6x0.8mm [EIA1608]

---

---

## 特征 Feature

- 重量轻, 结构紧凑 Light weight, compact
- 宽带大, 低成本 Wide bandwidth, low cost
- 高增益内置天线 Built-in antenna with high gain
- 工作温度 Operating Temp. : -40°C~+85°C

## 应用 Application

- 蓝牙,无线局域网,移动电视 Bluetooth, Wireless LAN, Mobile TV
- 家用射频系统 Home RF system, etc

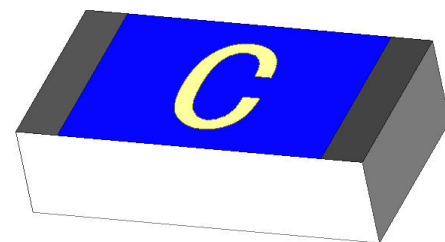

CS-2450-16-C

## 电气特性 Electrical Characteristics per line(TA=25°C)

参数Parameter	规格Specification	单位Units
频带 Frequency Band	2400~2483	MHz
极化 Polarization	Linear	
*峰值增益 Peak Gain	2.36	dBi
*峰值效率 Peak Efficiency	66.5%	%
阻抗 Impedance	50	$\Omega$

\*测试条件: 测试板尺寸98×65mm; 匹配电路:  $\pi$ 型匹配电路。Test condition: Test board size 98\*65 mm; Matching circuit: Pi matching circuit will be required

## 典型特征 Typical Characteristics

Fig.1 驻波比 VSWR

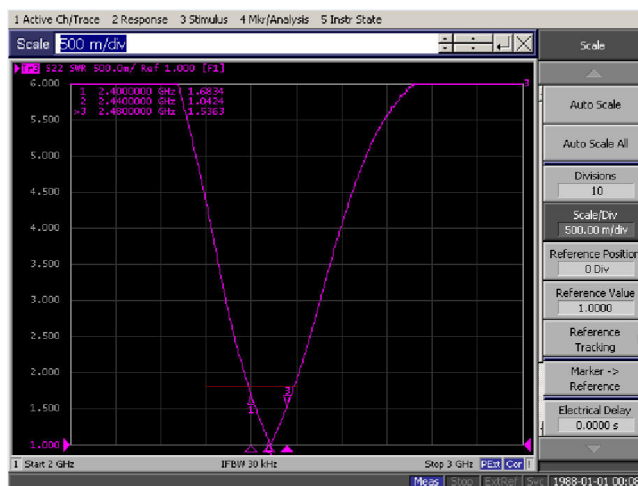

## 辐射模式 Radiation Pattern

增益模式是在暗室进行测试的，被测件放在桌肩位置，用标准的喇叭天线和矢量网络分析仪来收集数据。The Gain pattern is measured in FAR-field chamber. DUT is placed on the table of rotator, a standard horn antenna and Vector Network Analyzer is used to collect data.

Fig.2 暗室示意图

FAR-field Chamber

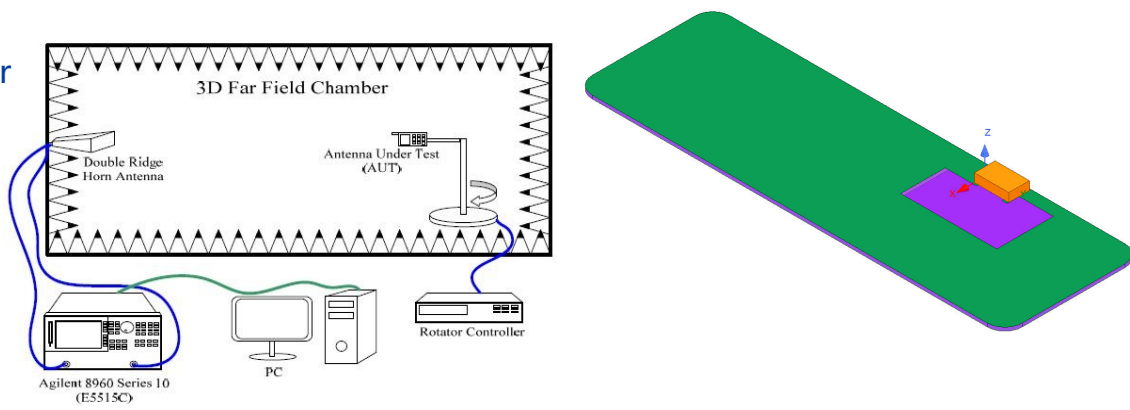

### 3D 增益模式

### 3D Gain Pattern (2400 MHz)

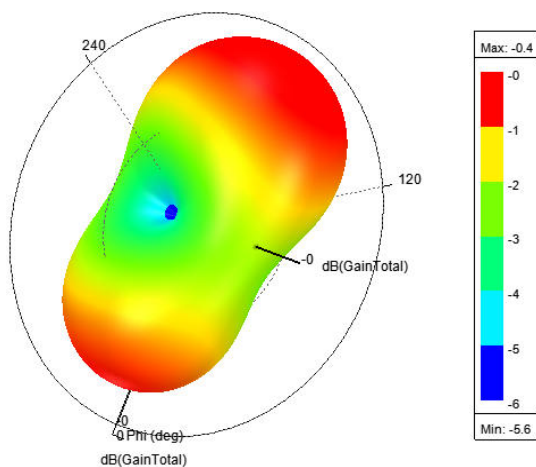

3D 增益模式

3D Gain Pattern (2450 MHz)

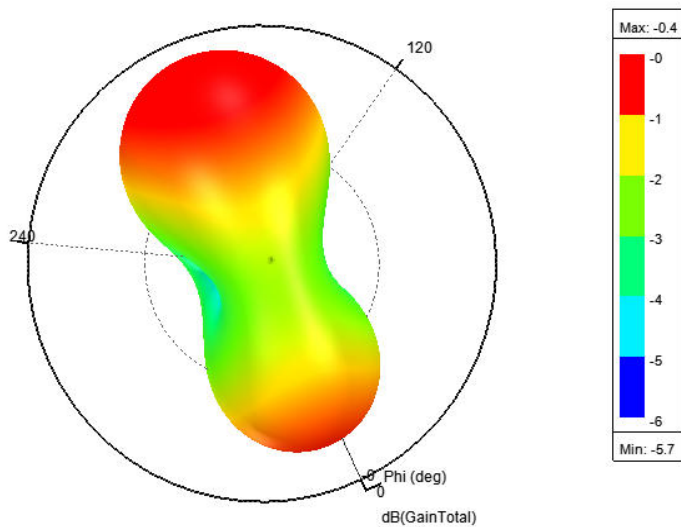

3D 增益模式

3D Gain Pattern (2500 MHz)

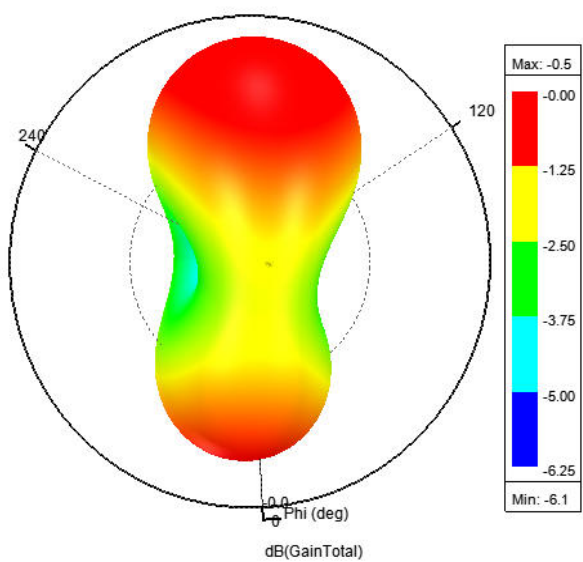

项目Item	环境Condition	规格Specification
热冲击 Thermal shock	1. 30±3 minutes at -40°C±5°C, 2. Convert to +105°C (5 minutes) 3. 30±3 minutes at +105°C±5°C, 4. Convert to -40°C (5 minutes) 5. Total 100 continuous cycles	No apparent damage Fulfill the electrical spec. after test.
抗湿性 Humidity resistance	1. Humidity: 85% R.H. 2. Temperature: 85±5°C 3. Time: 1000 hours.	No apparent damage Fulfill the electrical spec. after test.
耐高温性 High temperature resistance	No apparent damage Fulfill the electrical spec. after test.	1. Temperature: 150°C±5°C 2. Time: 1000 hours.
低温电阻 Low temperature resistance	1. Temperature: -40°C±5°C 2. Time: 1000 hours.	No apparent damage Fulfill the electrical spec. after test.
耐焊接热性 Soldering heat resistance	1. Solder bath temperature : 260±5°C 2. Bathing time: 10±1 seconds	No apparent damage
焊锡性 Solderability	The dipped surface of the terminal shall be at least 95% covered with solder after dipped in solder bath of 245±5°C for 3±1 seconds.	No apparent damage

### (2) 储存环境 Storage Condition

(a)仓库：温度应在0 ~ 30°C之间，湿度应小于60%湿度，产品应在交货之日起1年内使用。  
At warehouse: The temperature should be within 0 ~ 30°C and humidity should be less than 60% RH. The product should be used within 1 year from the time of elivery.

(b)在板：温度应在40 ~ 85°C之间，湿度应小于85%湿度。 On board: The temperature should be within -40~85°C and humidity should be less than 85% RH.

### (3) 工作环境温度 Operating Temperature Range

工作温度范围：-40°C to +85°C。 Operating temperature range : -40°C to +85°C.

### 推荐回流焊接曲线 Recommended Reflow Solder curve

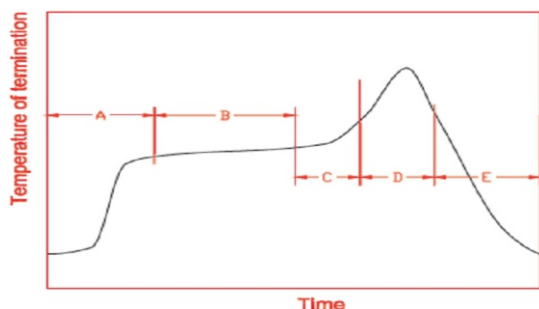

A	1 <sup>st</sup> rising temperature	The normal to Preheating temperature	30s to 60s
B	Preheating	140°C to 160°C	60s to 120s
C	2 <sup>nd</sup> rising temperature	Preheating to 200°C	20s to 40s
D	Main heating	if 220°C	50s~60s
		if 230°C	40s~50s
		if 240°C	30s~40s
		if 250°C	20s~40s
E	Regular cooling	if 260°C	20s~40s
		200°C to 100°C	1°C/s ~ 4°C/s

\*reference: J-STD-020C

### (1) 电烙铁的使用 Soldering Gun Procedure

以下注意事项仅针对使用电烙铁进行个别器件更换。

Note the follows, in case of using solder gun for replacement.

(a) 使用小于30W的电烙铁，温度不高于350°C，焊接时间小于3秒。

The tip temperature must be less than 350°C for the period within 3 seconds by using soldering gun under 30 W.

(b) 烙铁不可直接接触器件本体。

The soldering gun tip shall not touch this product directly.

### (2) 焊锡量 Soldering Volume

注意焊接过程中过多的焊锡量会损害器件本体。

Note that excess of soldering volume will easily get crack the body of this product.

### 产品尺寸 Product Dimension

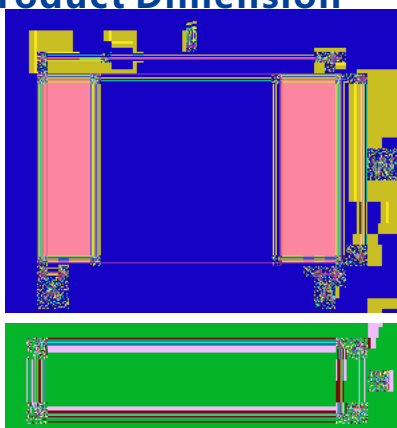

L	W	H	A
1.6±0.2	0.8±0.2	0.4±0.1	0.2±0.07

### 推荐焊盘&Evaluation Board

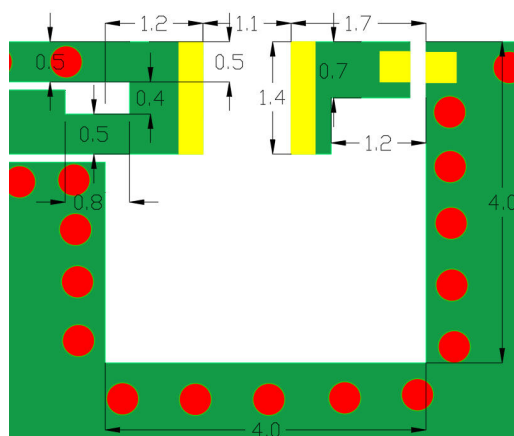
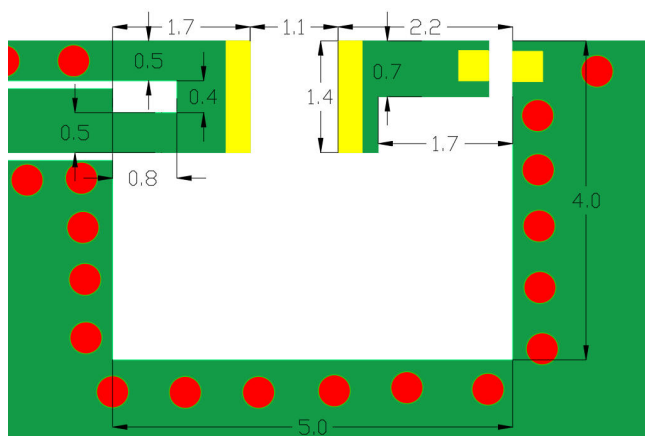

## 应用环境 Application Guide

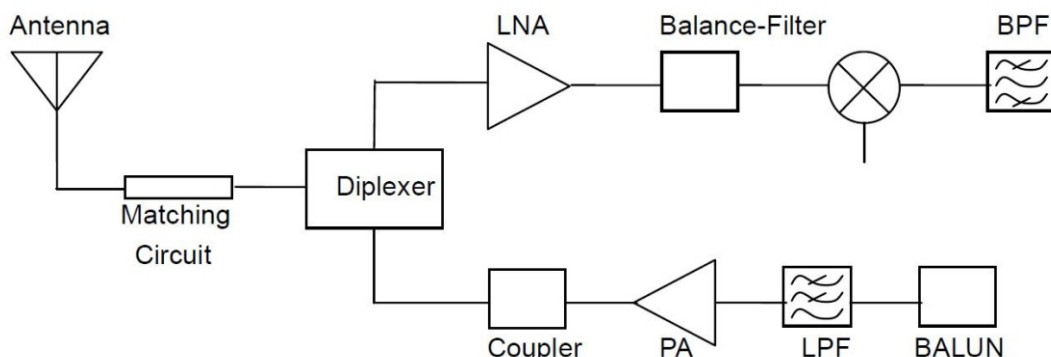

## 包装信息 Package Information

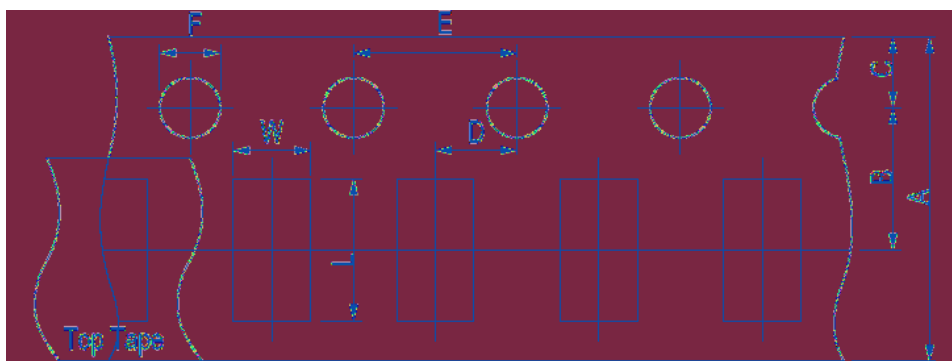

A	B	C	D	E	F	L	W
8.00±0.3	3.50± 0.05	1.75±0.1	2.00±0.05	4.00±0.1	1.50±0.1	2.30± 0.1	1.55± 0.1

## 编码规则 Part Number System

CS - 2450 - 16-C

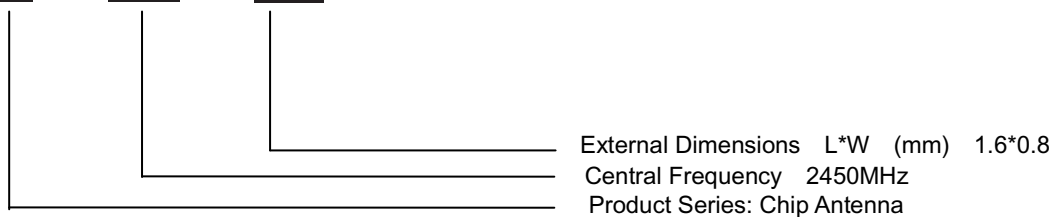

## 丝印 Marking



## 订货信息 Order Information

设备 Device	包装 Package	净重 Net Weight	运送方式 Carrier	数量 Quantity	认证 HSF Status
CS-2450-16-C	1608	0.002g	Tape&Reel	5000pcs	RoHS compliant

## 版本信息 Revision history

日期/Date	版本号/Revision	版本描述/Description of changes
2022-12-2	V1.0	First Version

The contents of this data sheet are subject to change without notice.  
Please confirm the specifications and delivery conditions when placing your order.

© Copyright 2015, Keweixin Electronics

All rights reserved