

FCC TEST REPORT

FCC ID: 2A7AD-WJAN

Report Number..... : ZKT-220530L3631-03

Date of Test..... : May 20, 2022 – Jun. 07, 2022

Date of issue : Jun. 07, 2022

Total number of pages : 87

Test Result : PASS

Testing Laboratory..... : **Shenzhen ZKT Technology Co., Ltd.**

Address : 1/F, No. 101, Building B, No. 6, Tangwei Community Industrial Avenue, Fuhai Street, Bao'an District, Shenzhen, China

Applicant's name : Shenzhen JoyeAuto Technology Co., Ltd.

Address : Room 1101, Building 19, Zhonghaixin Innovation Industry City, Jihua Street, Longgang District, Shenzhen

Manufacturer's name : Shenzhen JoyeAuto Technology Co., Ltd.

Address : Room 1101, Building 19, Zhonghaixin Innovation Industry City, Jihua Street, Longgang District, Shenzhen

Test specification:

Standard : FCC CFR Title 47 Part 15 Subpart C Section 15.247
ANSI C63.10:2013
KDB558074 D0115.247 Meas Guidance v 05r02

Test procedure..... : /

Non-standard test method : N/A

Test Report Form No. : TRF-EL-110_V0

Test Report Form(s) Originator : ZKT Testing

Master TRF : Dated: 2020-01-06

This device described above has been tested by ZKT, and the test results show that the equipment under test (EUT) is in compliance with the FCC requirements. And it is applicable only to the tested sample identified in the report.

This report shall not be reproduced except in full, without the written approval of ZKT, this document may be altered or revised by ZKT, personal only, and shall be noted in the revision of the document.

Product name..... : CarPlay Android BOX

Trademark : /

Model/Type reference : WJAN-PLUS, WJAN-4, WJAN-8E, WJAN-MINI, WJAN-PRO,
WJAN-MT, WJUC-3, WJUC-4, WJUC-PRO, WJUC-MAX

Ratings..... : DC 5.0V/1A from adapter or others

Testing procedure and testing location:

Testing Laboratory..... : **Shenzhen ZKT Technology Co., Ltd.**

Address..... : 1/F, No. 101, Building B, No. 6, Tangwei Community
Industrial Avenue, Fuhai Street, Bao'an District,
Shenzhen, China

Tested by (name + signature) : Alen He



Reviewer (name + signature)..... : Joe Liu

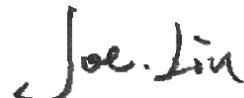

Approved (name + signature) : Lake Xie



Table of Contents

	Page
1. VERSION	5
2. SUMMARY OF TEST RESULTS	6
2.1 TEST FACILITY	7
2.2 MEASUREMENT UNCERTAINTY	7
3. GENERAL INFORMATION	7
3.1 GENERAL DESCRIPTION OF EUT	7
3.2 DESCRIPTION OF TEST MODES	8
3.3 BLOCK DIGRAM SHOWING THE CONFIGURATION OF SYSTEM TESTED	9
3.4 DESCRIPTION OF SUPPORT UNITS(CONDUCTED MODE)	9
3.5EQUIPMENTS LIST FOR ALL TEST ITEMS	10
4. EMC EMISSION TEST	12
4.1 CONDUCTED EMISSION MEASUREMENT	12
4.1.1 POWER LINE CONDUCTED EMISSION LIMITS	12
4.1.2 TEST PROCEDURE	12
4.1.3 DEVIATION FROM TEST STANDARD	12
4.1.4 TEST SETUP	13
4.1.5 EUT OPERATING CONDITIONS	13
4.1.5 TEST RESULTS	14
4.2 RADIATED EMISSION MEASUREMENT	14
4.2.1 RADIATED EMISSION LIMITS	16
4.2.2 TEST PROCEDURE	16
4.2.3 DEVIATION FROM TEST STANDARD	17
4.2.4 TEST SETUP	17
4.2.5 EUT OPERATING CONDITIONS	18
4.2.6 TEST RESULTS	19
5.RADIATED BAND EMISSIONMEASUREMENT	32
5.1 TEST REQUIREMENT:	32
5.2 TEST PROCEDURE	32
5.3 DEVIATION FROM TEST STANDARD	32
5.4 TEST SETUP	33
5.5 EUT OPERATING CONDITIONS	33
5.6 TEST RESULT	34
6.POWER SPECTRAL DENSITY TEST	39
6.1 APPLIED PROCEDURES / LIMIT	39
6.2 TEST PROCEDURE	39
6.3 DEVIATION FROM STANDARD	39
6.4 TEST SETUP	39
6.5 EUT OPERATION CONDITIONS	39

6.6 TEST RESULT	40
7. CHANNEL BANDWIDTH	45
7.1 APPLIED PROCEDURES / LIMIT	45
7.2 TEST PROCEDURE	45
7.3 DEVIATION FROM STANDARD	45
7.4 TEST SETUP	45
7.5 EUT OPERATION CONDITIONS	45
7.6 TEST RESULT	46
8. OUTPUT POWER TEST	51
8.1 APPLIED PROCEDURES/LIMIT	51
8.2 TEST PROCEDURE	51
8.3 DEVIATION FROM STANDARD	51
8.4 TEST SETUP	51
8.5 EUT OPERATION CONDITIONS	51
8.6 TEST RESULT	52
9. CONDUCTED BAND EDGE AND SPURIOUS EMISSION	53
9.1 APPLICABLE STANDARD	53
9.2 TEST PROCEDURE	53
9.3 DEVIATION FROM STANDARD	53
9.4 TEST SETUP	53
9.5 EUT OPERATION CONDITIONS	53
9.6 TEST RESULTS	53
10. ANTENNA REQUIREMENT	86
11. TEST SETUP PHOTO	87
12. EUT CONSTRUCTIONAL DETAILS	87

1. VERSION

Report No.	Version	Description	Approved
ZKT-220530L3631-03	Rev.01	Initial issue of report	Jun. 07, 2022

2. SUMMARY OF TEST RESULTS

Test procedures according to the technical standards:

FCC Part15 (15.247) , Subpart C			
Standard Section	Test Item	Result	Remark
FCC part 15.203/15.247 (c)	Antenna requirement	PASS	
FCC part 15.207	AC Power Line Conducted Emission	PASS	
FCC part 15.247 (b)(3)	Conducted Peak Output Power	PASS	
FCC part 15.247 (a)(2)	Channel Bandwidth& 99% OCB	PASS	
FCC part 15.247 (e)	Power Spectral Density	PASS	
FCC part 15.247(d)	Band Edge	PASS	
FCC part 15.205/15.209	Spurious Emission	PASS	

NOTE:

(1) " N/A" denotes test is not applicable in this Test Report

2.1 TEST FACILITY

Shenzhen ZKT Technology Co., Ltd.

Add. : 1/F, No. 101, Building B, No. 6, Tangwei Community Industrial Avenue, Fuhai Street, Bao'an District, Shenzhen, China

FCC Test Firm Registration Number: 692225

Designation Number: CN1299

IC Registered No.: 27033

2.2 MEASUREMENT UNCERTAINTY

The reported uncertainty of measurement $y \pm U$ · where expanded uncertainty U is based on a standard uncertainty multiplied by a coverage factor of $k=2$ · providing a level of confidence of approximately 95 % .

No.	Item	Uncertainty
1	Conducted Emission Test	$\pm 1.38\text{dB}$
2	RF power conducted	$\pm 0.16\text{dB}$
3	Spurious emissions conducted	$\pm 0.21\text{dB}$
4	All emissions radiated(<1G)	$\pm 4.68\text{dB}$
5	All emissions radiated(>1G)	$\pm 4.89\text{dB}$
6	Temperature	$\pm 0.5^{\circ}\text{C}$
7	Humidity	$\pm 2\%$

3. GENERAL INFORMATION

3.1 GENERAL DESCRIPTION OF EUT

Product Name:	CarPlay Android BOX
Model No.:	WJAN-PLUS
Serial No.:	WJAN-4, WJAN-8E, WJAN-MINI, WJAN-PRO, WJAN-MT, WJUC-3, WJUC-4, WJUC-PRO, WJUC-MAX
Hardware Version:	V2.0
Software Version:	V1.3
Sample(s) Status:	Engineer sample
Channel numbers:	802.11b/802.11g /802.11n(HT20):11 / 802.11n(HT40):7
Channel separation:	5MHz
Modulation technology:	802.11b: Direct Sequence Spread Spectrum(DSSS) 802.11g/802.11n(H20)/802.11n(HT40): Orthogonal Frequency Division Multiplexing(OFDM)
Antenna Type:	FPC antenna
Antenna gain:	WIFI ANT1: 2dBi; WIFI ANT2: 2dBi ; MIMO:5.01dBi
Power supply:	DC 5.0V/1A from adapter or others
POWER ADAPTER:	/

Operation Frequency each of channel							
Channel	Frequency	Chann el	Frequency	Chann el	Frequency	Chann el	Frequency
1	2412MHz	4	2427MHz	7	2442MHz	10	2457MHz
2	2417MHz	5	2432MHz	8	2447MHz	11	2462MHz
3	2422MHz	6	2437MHz	9	2452MHz	X	

Note:

In section 15.31(m), regards to the operating frequency range over 10 MHz, the Lowest frequency, the middle frequency, and the highest frequency of channel were selected to perform the test, and the selected channel see below:

Test channel	Frequency (MHz)
	802.11b/802.11g/802.11n(HT20)
Lowest channel	2412MHz
Middle channel	2437MHz
Highest channel	2462MHz

Test channel	Frequency (MHz)
	802.11n(HT40)
Lowest channel	2422MHz
Middle channel	2437MHz
Highest channel	2452MHz

Worst Case Configuration

Description	MIMO (802.11N-HT20 low channel)
Antenna	MIMO
Channel	1
Operating Frequency (MHz)	2412
Data Rate (Mbps)	6.5Mbps

3.2 DESCRIPTION OF TEST MODES

Transmitting mode	Keep the EUT in continuously transmitting mode
Remark: During the test, the duty cycle >98%, the test voltage was tuned from 85% to 115% of the nominal rated supply voltage, and found that the worst case was under the nominal rated supply condition. So the report just shows that condition's data.	

We have verified the construction and function in typical operation. All the test modes were carried out with the EUT in transmitting operation, which was shown in this test report and defined as follows:
--

Pre-scan all kind of data rate in lowest channel, and found the follow list which it was worst case.

Mode	802.11b	802.11g	802.11n (HT20)	802.11n (HT40)
Data rate	11Mbps	54Mbps	MCS7	MCS7

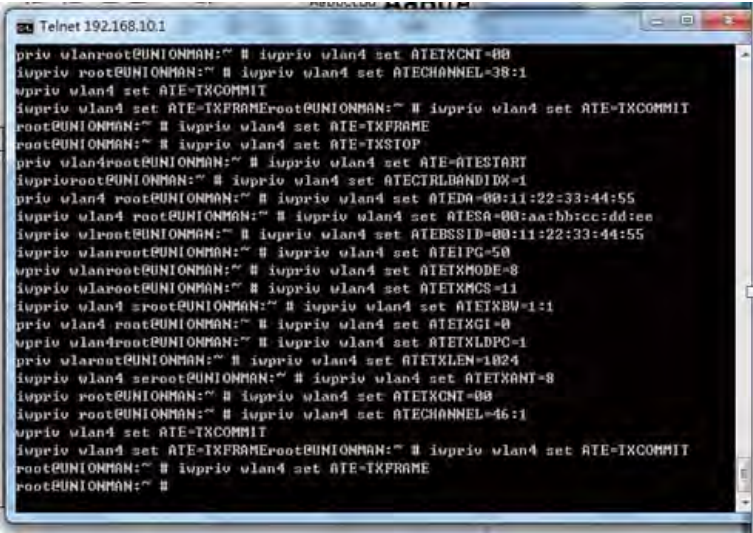
Test Software	Realtek Test Tool
	 <pre> Telnet 192.168.10.1 priv wlan4root@UNIONMAN:~ # iupriv wlan4 set ATEIXCNI=08 iupriv root@UNIONMAN:~ # iupriv wlan4 set ATECHANNEL=38:1 iupriv wlan4 set ATE-IXCOMMIT iupriv wlan4 set ATE-IXFRAMEroot@UNIONMAN:~ # iupriv wlan4 set ATE-IXCOMMIT root@UNIONMAN:~ # iupriv wlan4 set ATE-IXFRAME root@UNIONMAN:~ # iupriv wlan4 set ATE-IXSTOP priv wlan4root@UNIONMAN:~ # iupriv wlan4 set ATE-ATESTART iupriv root@UNIONMAN:~ # iupriv wlan4 set ATECTRLBANDID=1 priv wlan4 root@UNIONMAN:~ # iupriv wlan4 set ATEEA=00:11:22:33:44:55 iupriv wlan4 root@UNIONMAN:~ # iupriv wlan4 set ATEEA=00:aa:bb:cc:dd:ee iupriv wlan4 root@UNIONMAN:~ # iupriv wlan4 set ATEBSSID=00:11:22:33:44:55 iupriv wlan4 root@UNIONMAN:~ # iupriv wlan4 set ATEIFG=50 iupriv wlan4 root@UNIONMAN:~ # iupriv wlan4 set ATEIXMODE=8 iupriv wlan4 root@UNIONMAN:~ # iupriv wlan4 set ATEIXMCS=11 iupriv wlan4 root@UNIONMAN:~ # iupriv wlan4 set ATEIXBU=1:1 priv wlan4 root@UNIONMAN:~ # iupriv wlan4 set ATEIXGI=8 iupriv wlan4 root@UNIONMAN:~ # iupriv wlan4 set ATEIXLDP=1 priv wlan4 root@UNIONMAN:~ # iupriv wlan4 set ATEIXLEN=1024 iupriv wlan4 root@UNIONMAN:~ # iupriv wlan4 set ATEIXANT=8 iupriv root@UNIONMAN:~ # iupriv wlan4 set ATEIXCNI=08 iupriv root@UNIONMAN:~ # iupriv wlan4 set ATECHANNEL=46:1 iupriv wlan4 set ATE-IXCOMMIT iupriv wlan4 set ATE-IXFRAMEroot@UNIONMAN:~ # iupriv wlan4 set ATE-IXCOMMIT root@UNIONMAN:~ # iupriv wlan4 set ATE-IXFRAME root@UNIONMAN:~ # </pre>
Power level setup	<30dBm

3.3 BLOCK DIGRAM SHOWING THE CONFIGURATION OF SYSTEM TESTED

Conducted Emission



Radiated Emission



Conducted Spurious

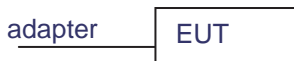

3.4 DESCRIPTION OF SUPPORT UNITS(CONDUCTED MODE)

The EUT has been tested as an independent unit together with other necessary accessories or support units. The following support units or accessories were used to form a representative test configuration during the tests.

Item	Equipment	Mfr/Brand	Model/Type No.	Series No.	Note
	PC	HP	HP40		Provide by lab

	adapter	HUAWEI	HW-050500DFQ	Provide by lab	SDOC

Item	Shielded Type	Ferrite Core	Length	Note

Note:

- (1) The support equipment was authorized by Declaration of Confirmation.
- (2) For detachable type I/O cable should be specified the length in cm in 『Length』 column.

3.5EQUIPMENTS LIST FOR ALL TEST ITEMS

Radiation Test equipment

Item	Equipment	Manufacturer	Type No.	Serial No.	Last calibration	Calibrated until
1	Spectrum Analyzer (9kHz-26.5GHz)	KEYSIGHT	9020A	MY45109572	Sep. 21, 2021	Sep. 20, 2022
2	Spectrum Analyzer (1GHz-40GHz)	Agilent	E4446A	100363	Sep. 21, 2021	Sep. 20, 2022
3	Test Receiver (9kHz-7GHz)	R&S	ESCI7	101169	Sep. 21, 2021	Sep. 20, 2022
4	Bilog Antenna (30MHz-1400MHz)	Schwarzbeck	VULB9168	00877	Sep. 21, 2021	Sep. 20, 2022
5	Horn Antenna (1GHz-18GHz)	SCHWARZBEC K	BBHA9120D	1541	Sep. 21, 2021	Sep. 20, 2022
6	Horn Antenna (18GHz-40GHz)	A.H. System	SAS-574	588	Sep. 21, 2021	Sep. 20, 2022
7	Amplifier (30-1000MHz)	EM Electronics	EM330 Amplifier	N/A	Sep. 21, 2021	Sep. 20, 2022
8	Amplifier (1GHz-40GHz)	QUANJUDA	DLE-161	097	Sep. 21, 2021	Sep. 20, 2022
9	Loop Antenna (9KHz-30MHz)	SCHWARZBEC K	FMZB1519B	014	Sep. 21, 2021	Sep. 20, 2022
10	RF cables1 (9kHz-30MHz)	N/A	9kHz-30MHz	N/A	Sep. 21, 2021	Sep. 20, 2022
11	RF cables2 (30MHz-1GHz)	N/A	30MHz-1GHz	N/A	Sep. 21, 2021	Sep. 20, 2022
12	RF cables3 (1GHz-40GHz)	N/A	1GHz-40GHz	N/A	Sep. 21, 2021	Sep. 20, 2022
13	CMW500 Test	R&S	CMW500	106504	Sep. 21, 2021	Sep. 20, 2022
14	ESG Signal Generator	Agilent	E4421B	GB40051203	Sep. 21, 2021	Sep. 20, 2022
15	Signal Generator	Agilent	N5182A	MY47420215	Sep. 21, 2021	Sep. 20, 2022
16	D.C. Power Supply	LongWei	TPR-6405D	\	\	\
17	Software	Frad	EZ-EMC	FA-03A2 RE	\	\

Conduction Test equipment

Item	Kind of Equipment	Manufacturer	Type No.	Serial No.	Last calibration	Calibrated until
1	LISN	R&S	ENV216	101471	Sep. 21, 2021	Sep. 20, 2022
2	LISN	CYBERTEK	EM5040A	E185040014 9	Sep. 21, 2021	Sep. 20, 2022
3	Test Cable	N/A	C01	N/A	Sep. 21, 2021	Sep. 20, 2022
4	Test Cable	N/A	C02	N/A	Sep. 21, 2021	Sep. 20, 2022
5	EMI Test Receiver	R&S	ESRP3	101946	Sep. 21, 2021	Sep. 20, 2022
6	Absorbing Clamp	DZ	ZN23201	N/A	Sep. 21, 2021	Sep. 20, 2022

4. EMC EMISSION TEST

4.1 CONDUCTED EMISSION MEASUREMENT

Test Requirement:	FCC Part15 C Section 15.207
Test Method:	ANSI C63.10:2013
Test Frequency Range:	150KHz to 30MHz
Receiver setup:	RBW=9KHz, VBW=30KHz, Sweep time=auto

4.1.1 POWER LINE CONDUCTED EMISSION LIMITS

FREQUENCY (MHz)	Limit (dBuV)		Standard
	Quasi-peak	Average	
0.15 -0.5	66 - 56 *	56 - 46 *	FCC
0.50 -5.0	56.00	46.00	FCC
5.0 -30.0	60.00	50.00	FCC

Note:

(1) *Decreases with the logarithm of the frequency.

4.1.2 TEST PROCEDURE

1. The equipment was set up as per the test configuration to simulate typical actual usage per the user's manual. The EUT is a tabletop system; a wooden table with a height of 0.8 meters is used and is placed on the ground plane as per ANSI C63.10:2013.
2. Support equipment, if needed, was placed as per ANSI C63.10:2013
3. All I/O cables were positioned to simulate typical actual usage as per ANSI C63.10:2013.
4. The adapter received AC120V/60Hz power through a Line Impedance Stabilization Network (LISN) which supplied power source and was grounded to the ground plane.
5. All support equipments received AC power from a second LISN, if any.
6. The EUT test program was started. Emissions were measured on each current carrying line of the EUT using a spectrum Analyzer / Receiver connected to the LISN powering the EUT. The LISN has two monitoring points: Line 1 (Hot Side) and Line 2 (Neutral Side). Two scans were taken: one with Line 1 connected to Analyzer / Receiver and Line 2 connected to a 50 ohm load; the second scan had Line 1 connected to a 50 ohm load and Line 2 connected to the Analyzer / Receiver.
7. Analyzer / Receiver scanned from 150 KHz to 30MHz for emissions in each of the test modes.e.
8. For the actual test configuration, please refer to the related Item –EUT Test Photos.

4.1.3 DEVIATION FROM TEST STANDARD

No deviation

4.1.4 TEST SETUP

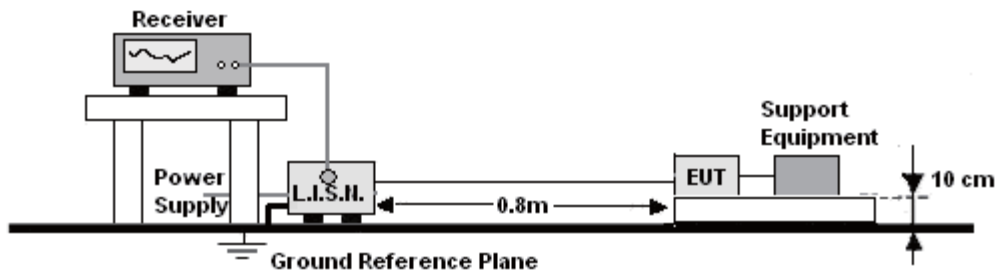

4.1.5 EUT OPERATING CONDITIONS

The EUT was configured for testing in a typical fashion (as a customer would normally use it). The EUT has been programmed to continuously transmit during test. This operating condition was tested and used to collect the included data.

4.1.5 TEST RESULTS

Temperature :	26°C	Relative Humidity :	54%
Pressure :	101kPa	Phase :	L
Test Voltage :	AC 120V/60Hz	Test mode	WIFI

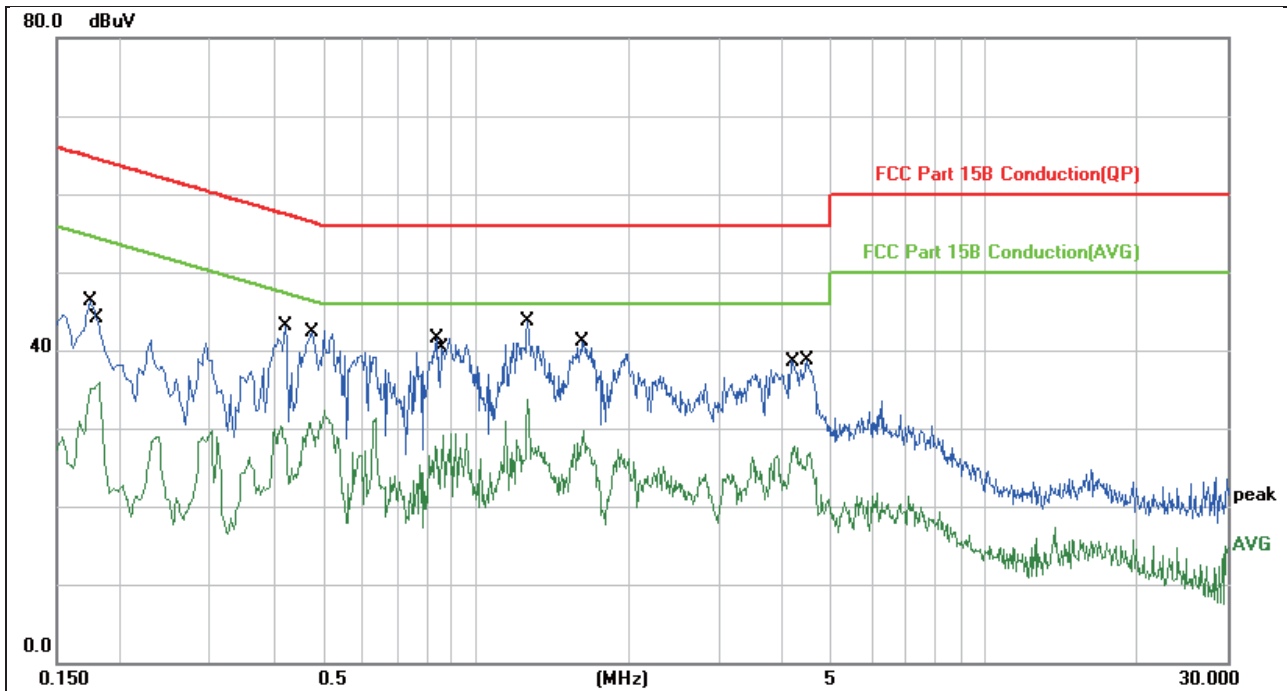

No.	Mk.	Freq. MHz	Reading Level dBuV	Correct Factor dB	Measurement dBuV	Limit dBuV	Over dB	Detector	Comment
1		0.1740	36.24	10.07	46.31	64.76	-18.45	QP	
2		0.1819	25.85	10.07	35.92	54.39	-18.47	AVG	
3		0.4220	32.86	10.20	43.06	57.41	-14.35	QP	
4		0.4740	20.55	10.20	30.75	46.44	-15.69	AVG	
5		0.8420	31.31	10.19	41.50	56.00	-14.50	QP	
6		0.8660	18.85	10.19	29.04	46.00	-16.96	AVG	
7	*	1.2660	33.54	10.14	43.68	56.00	-12.32	QP	
8		1.2660	23.49	10.14	33.63	46.00	-12.37	AVG	
9		1.6220	31.01	10.09	41.10	56.00	-14.90	QP	
10		1.6300	19.53	10.08	29.61	46.00	-16.39	AVG	
11		4.2260	17.76	9.85	27.61	46.00	-18.39	AVG	
12		4.4699	28.79	9.89	38.68	56.00	-17.32	QP	

Notes:

1. An initial pre-scan was performed on the line and neutral lines with peak detector.
2. Quasi-Peak and Average measurement were performed at the frequencies with maximized peak emission.
3. Measurement Level = Reading level + Correct Factor

Temperature :	26°C	Relative Humidity :	54%
Pressure :	101kPa	Phase :	N
Test Voltage :	AC 120V/60Hz	Test mode	WIFI

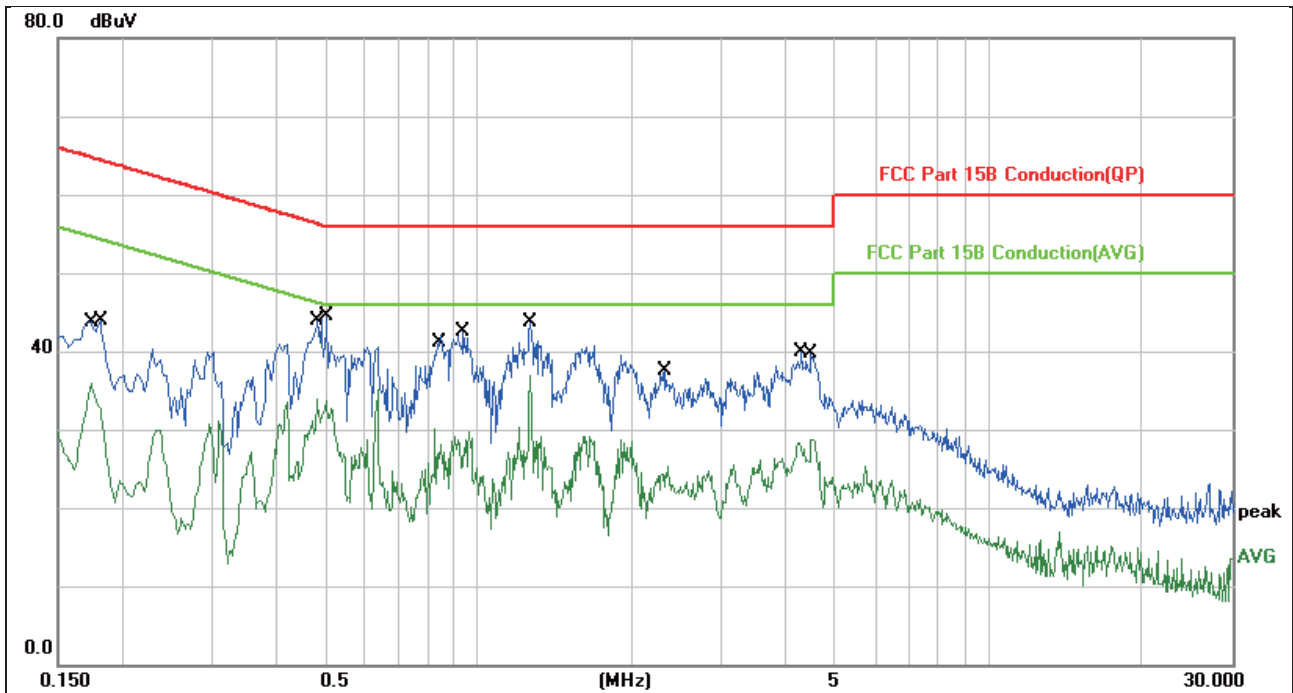

No. Mk.	Freq. MHz	Reading Level dBuV	Correct Factor dB	Measurement dBuV	Limit dBuV	Over dB	Detector	Comment
1	0.1758	24.85	10.07	34.92	54.68	-19.76	AVG	
2	0.1819	33.84	10.07	43.91	64.39	-20.48	QP	
3	0.4820	23.73	10.20	33.93	46.30	-12.37	AVG	
4	0.5060	34.23	10.20	44.43	56.00	-11.57	QP	
5	0.8260	19.88	10.19	30.07	46.00	-15.93	AVG	
6	0.9380	32.37	10.18	42.55	56.00	-13.45	QP	
7	1.2660	33.57	10.14	43.71	56.00	-12.29	QP	
8 *	1.2660	26.80	10.14	36.94	46.00	-9.06	AVG	
9	2.3300	27.58	10.01	37.59	56.00	-18.41	QP	
10	2.3460	15.33	10.01	25.34	46.00	-20.66	AVG	
11	4.3140	29.95	9.86	39.81	56.00	-16.19	QP	
12	4.4899	18.76	9.89	28.65	46.00	-17.35	AVG	

Notes:

1. An initial pre-scan was performed on the line and neutral lines with peak detector.
2. Quasi-Peak and Average measurement were performed at the frequencies with maximized peak emission.
3. Measurement Level = Reading level + Correct Factor

4.2 RADIATED EMISSION MEASUREMENT

Test Requirement:	FCC Part15 C Section 15.209				
Test Method:	ANSI C63.10:2013				
Test Frequency Range:	9kHz to 25GHz				
Test site:	Measurement Distance: 3m				
Receiver setup:	Frequency	Detector	RBW	VBW	Value
	9KHz-150KHz	Quasi-peak	200Hz	600Hz	Quasi-peak
	150KHz-30MHz	Quasi-peak	9KHz	30KHz	Quasi-peak
	30MHz-1GHz	Quasi-peak	120KHz	300KHz	Quasi-peak
	Above 1GHz	Peak	1MHz	3MHz	Peak
Peak		1MHz	10Hz	Average	

4.2.1 RADIATED EMISSION LIMITS

Frequencies (MHz)	Field Strength (micorvolts/meter)	Measurement Distance (meters)
0.009~0.490	2400/F(KHz)	300
0.490~1.705	24000/F(KHz)	30
1.705~30.0	30	30
30~88	100	3
88~216	150	3
216~960	200	3
Above 960	500	3

LIMITS OF RADIATED EMISSION MEASUREMENT

FREQUENCY (MHz)	Limit (dBuV/m) (at 3M)	
	PEAK	AVERAGE
Above 1000	74	54

Notes:

- (1) The limit for radiated test was performed according to FCC PART 15C.
- (2) The tighter limit applies at the band edges.
- (3) Emission level (dBuV/m)=20log Emission level (uV/m).

4.2.2 TEST PROCEDURE

Below 1GHz test procedure as below:

- a. The EUT was placed on the top of a rotating table 0.1 meters above the ground at a 3 meter semi-anechoiccamber. The table was rotated 360 degrees to determine the position of the highest radiation.
- b. The EUT was set 3 meters away from the interference-receiving antenna, which was mounted on the top of variable-height antenna tower.

- c. The antenna height is varied from one meter to four meters above the ground to determine the maximum value of the field strength. Both horizontal and vertical polarizations of the antenna are set to make the measurement.
- d. For each suspected emission, the EUT was arranged to its worst case and then the antenna was tuned to heights from 1 meter to 4 meters (for the test frequency of below 30MHz, the antenna was tuned to heights 1 meter) and the rotatable table was turned from 0 degrees to 360 degrees to find the maximum reading.
- e. The test-receiver system was set to Peak Detect Function and Specified Bandwidth with Maximum Hold Mode.
- f. If the emission level of the EUT in peak mode was 10dB lower than the limit specified, then testing could be stopped and the peak values of the EUT would be reported. Otherwise the emissions that did not have 10dB margin would be re-tested one by one using peak, quasi-peak or average method as specified and then reported in a data sheet.

Above 1GHz test procedure as below:

- g. Different from above is the test site, change from Semi- Anechoic Chamber to fully Anechoic Chamber and change from table 0.8 metre to 1.5 metre (Above 18GHz the distance is 1 meter and table is 1.5 metre).
- h. Test the EUT in the lowest channel, the middle channel, the Highest channel

Note:

Both horizontal and vertical antenna polarities were tested and performed pretest to three orthogonal axis. The worst case emissions were reported

4.2.3 DEVIATION FROM TEST STANDARD

No deviation

4.2.4 TEST SETUP

(A) Radiated Emission Test-Up Frequency Below 30MHz

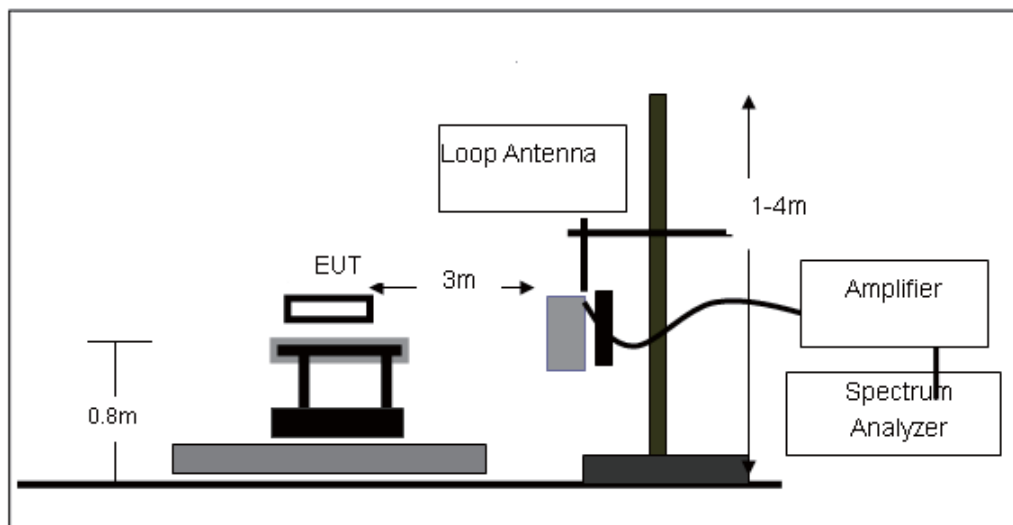

(B) Radiated Emission Test-Up Frequency 30MHz~1GHz

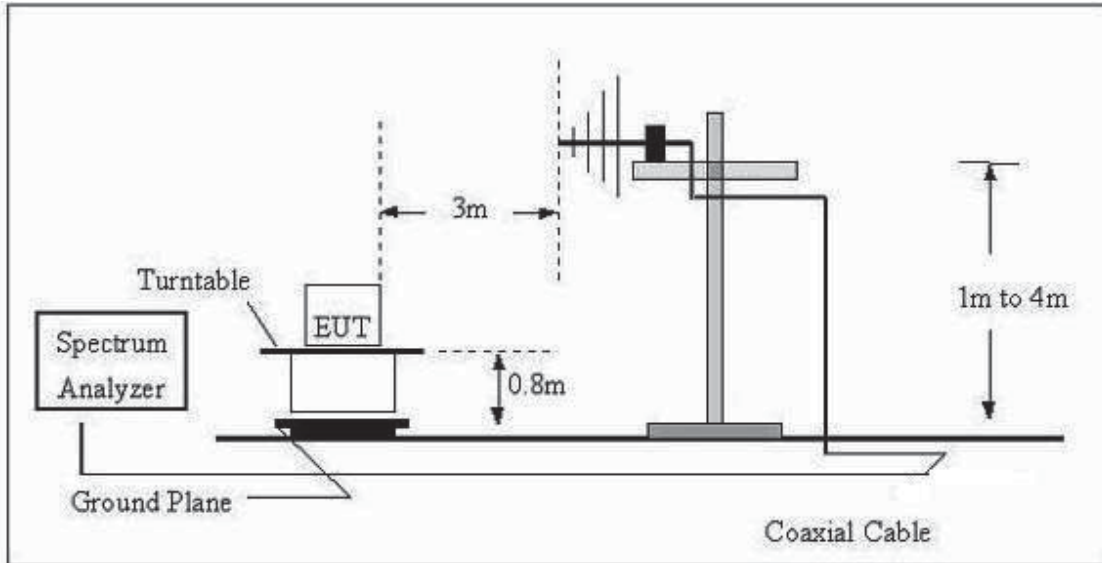

(C) Radiated Emission Test-Up Frequency Above 1GHz

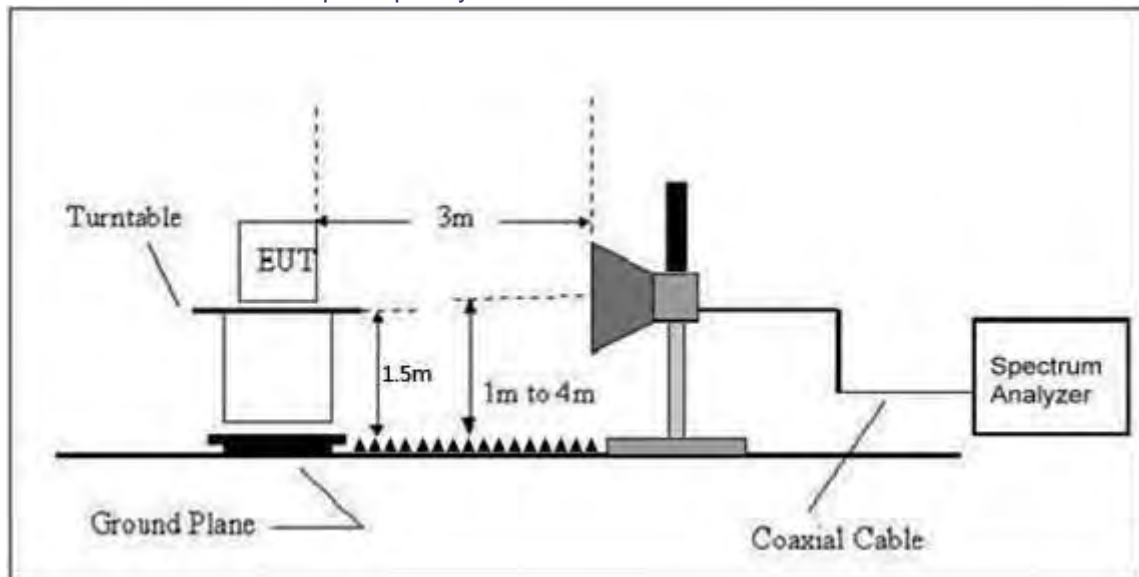

4.2.5 EUT OPERATING CONDITIONS

The EUT tested system was configured as the statements of 2.4 Unless otherwise a special operating condition is specified in the follows during the testing.

4.2.6 TEST RESULTS

Between 9KHz – 30MHz

The emission from 9 kHz to 30MHz was pre-tested and found the result was 20dB lower than the limit, and according to 15.31(o) & RSS-Gen 6.13, the test result no need to reported.

Between 30MHz – 1GHz

Temperature:	26°C	Relative Humidity:	54%
Pressure:	101kPa	Polarization:	Horizontal
Test Voltage:	AC 120V	Test mode	WIFI

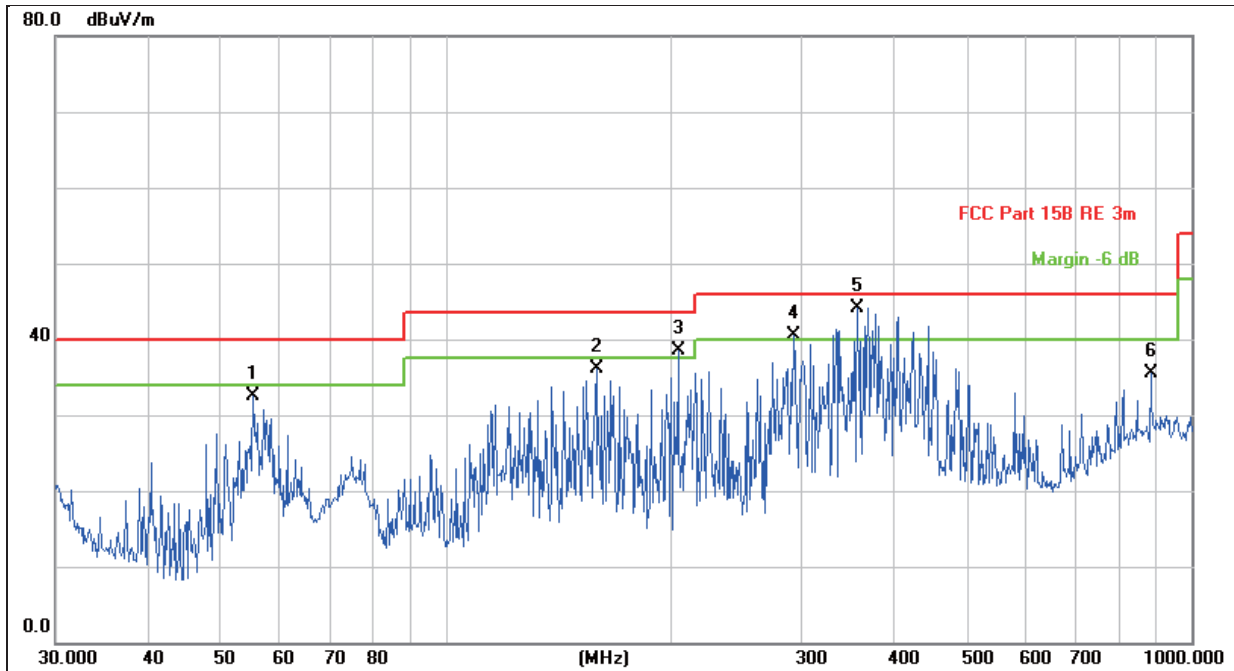

No.	Mk.	Freq. MHz	Reading Level dBuV	Correct Factor dB/m	Measure- ment dBuV/m	Limit dBuV/m	Over dB	Detector	Antenna Height cm	Table Degree degree	Comment
1		55.2207	46.14	-13.70	32.44	40.00	-7.56	QP	100	360	
2		159.2251	41.82	-5.74	36.08	43.50	-7.42	QP	100	360	
3	!	204.9551	45.21	-6.78	38.43	43.50	-5.07	QP	100	360	
4	!	293.0842	44.70	-4.20	40.50	46.00	-5.50	QP	100	360	
5	*	356.6758	46.84	-2.66	44.18	46.00	-1.82	QP	100	360	
6		881.4067	28.76	6.70	35.46	46.00	-10.54	QP	100	360	

Temperature:	26°C	Relative Humidity:	54%
Pressure:	101kPa	Polarization:	Vertical
Test Voltage:	AC 120V	Test mode	WIFI

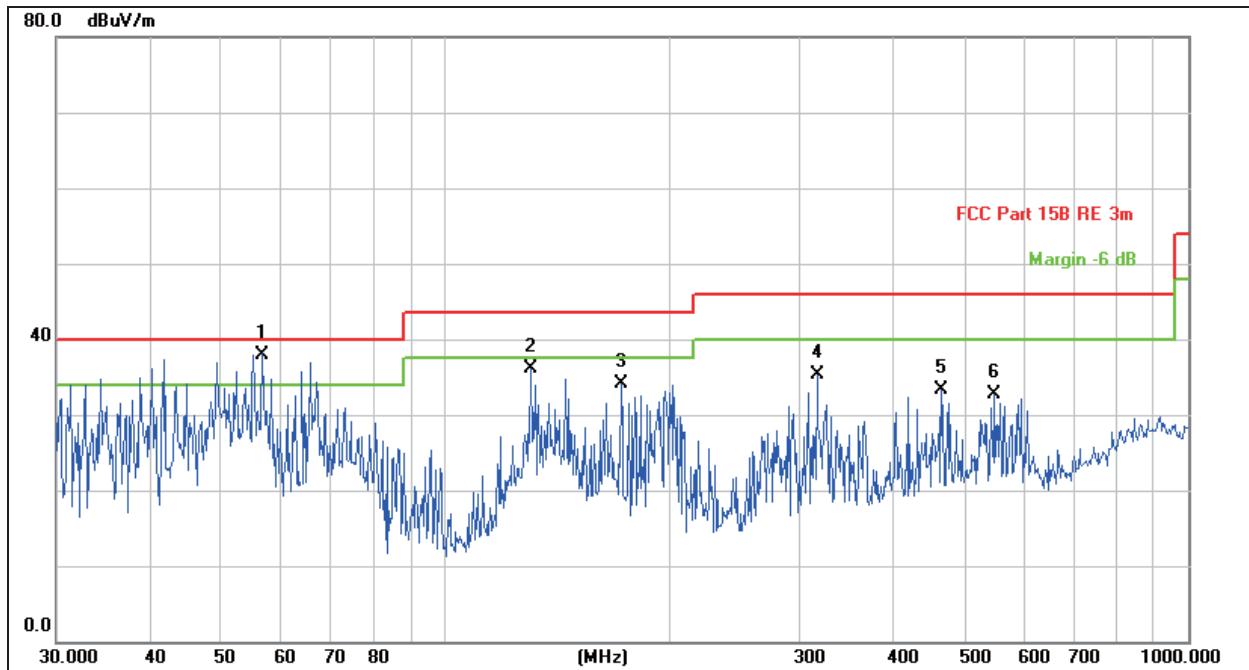

No.	Mk.	Freq.	Reading Level	Correct Factor	Measurement	Limit	Over	Antenna Height	Table Degree		
		MHz	dBuV	dB/m	dBuV/m	dBuV/m	dB	Detector	cm	degree	Comment
1	*	56.7917	54.11	-16.51	37.60	40.00	-2.40	QP	100	0	
2		130.3789	41.20	-5.15	36.05	43.50	-7.45	QP	100	0	
3		172.5988	40.90	-6.79	34.11	43.50	-9.39	QP	100	0	
4		316.5890	38.77	-3.43	35.34	46.00	-10.66	QP	100	0	
5		465.5994	33.54	-0.33	33.21	46.00	-12.79	QP	100	0	
6		549.0195	32.19	0.57	32.76	46.00	-13.24	QP	100	0	

Remarks:

1. Final Level = Receiver Read level + Antenna Factor + Cable Loss – Preamplifier Factor
2. The emission levels of other frequencies are very lower than the limit and not show in test report.
3. The test data shows only the worst case GFSK mode

1GHz~25GHz

802.11b-ANT1

Polar (H/V)	Frequency	Meter Reading	Pre-ampl ifier	Cable Loss	Antenna Factor	Emission Level	Limits	Margin	Detect or Type
	(MHz)	(dBuV)	(dB)	(dB)	(dB)	(dBuV/m)	(dBuV/ m)	(dB)	
Low Channel:2412MHz									
V	4824	46.71	30.55	5.77	24.66	46.59	74.00	-27.41	PK
V	4824	35.33	30.55	5.77	24.66	35.21	54.00	-18.79	AV
V	7236	45.81	30.33	6.32	24.55	46.35	74.00	-27.65	PK
V	7236	35.47	30.33	6.32	24.55	36.01	54.00	-17.99	AV
V	9648	43.26	30.85	7.45	24.69	44.55	74.00	-29.45	PK
V	9648	34.73	30.85	7.45	24.69	36.02	54.00	-17.98	AV
H	4824	45.90	30.55	5.77	24.66	45.78	74.00	-28.22	PK
H	4824	35.59	30.55	5.77	24.66	35.47	54.00	-18.53	AV
H	7236	46.91	30.33	6.32	24.55	47.45	74.00	-26.55	PK
H	7236	35.50	30.33	6.32	24.55	36.04	54.00	-17.96	AV
H	9648	43.58	30.85	7.45	24.69	44.87	74.00	-29.13	PK
H	9648	35.22	30.85	7.45	24.69	36.51	54.00	-17.49	AV

Polar (H/V)	Frequency	Meter Reading	Pre-ampl ifier	Cable Loss	Antenna Factor	Emission Level	Limits	Margin	Detect or Type
	(MHz)	(dBuV)	(dB)	(dB)	(dB)	(dBuV/m)	(dBuV/ m)	(dB)	
Middle Channel:2437MHz									
V	4874	46.00	30.55	5.77	24.66	45.88	74.00	-28.12	PK
V	4874	36.57	30.55	5.77	24.66	36.45	54.00	-17.55	AV
V	7311	46.69	30.33	6.32	24.55	47.23	74.00	-26.77	PK
V	7311	33.41	30.33	6.32	24.55	33.95	54.00	-20.05	AV
V	9748	42.70	30.85	7.45	24.69	43.99	74.00	-30.01	PK
V	9748	33.51	30.85	7.45	24.69	34.80	54.00	-19.20	AV
H	4874	46.52	30.55	5.77	24.66	46.40	74.00	-27.60	PK
H	4874	37.53	30.55	5.77	24.66	37.41	54.00	-16.59	AV
H	7311	46.94	30.33	6.32	24.55	47.48	74.00	-26.52	PK
H	7311	34.68	30.33	6.32	24.55	35.22	54.00	-18.78	AV
H	9748	41.38	30.85	7.45	24.69	42.67	74.00	-31.33	PK
H	9748	32.92	30.85	7.45	24.69	34.21	54.00	-19.79	AV

Polar (H/V)	Frequency	Meter Reading	Pre-ampli fier	Cable Loss	Antenna Factor	Emission Level	Limits	Margin	Detect or Type
	(MHz)	(dBuV)	(dB)	(dB)	(dB)	(dBuV/m)	(dBuV/ m)	(dB)	
High Channel:2462MHz									
V	4924	46.69	30.55	5.77	24.66	46.57	74.00	-27.43	PK
V	4924	36.82	30.55	5.77	24.66	36.70	54.00	-17.30	AV
V	7386	46.64	30.33	6.32	24.55	47.18	74.00	-26.82	PK
V	7386	34.22	30.33	6.32	24.55	34.76	54.00	-19.24	AV
V	9848	41.57	30.85	7.45	24.69	42.86	74.00	-31.14	PK
V	9848	33.10	30.85	7.45	24.69	34.39	54.00	-19.61	AV
H	4924	47.20	30.55	5.77	24.66	47.08	74.00	-26.92	PK
H	4924	36.51	30.55	5.77	24.66	36.39	54.00	-17.61	AV
H	7386	46.74	30.33	6.32	24.55	47.28	74.00	-26.72	PK
H	7386	34.11	30.33	6.32	24.55	34.65	54.00	-19.35	AV
H	9848	41.74	30.85	7.45	24.69	43.03	74.00	-30.97	PK
H	9848	32.45	30.85	7.45	24.69	33.74	54.00	-20.26	AV

802.11g-ANT1

Polar (H/V)	Frequency	Meter Reading	Pre-ampl ifier	Cable Loss	Antenna Factor	Emission Level	Limits	Margin	Detect or Type
	(MHz)	(dBuV)	(dB)	(dB)	(dB)	(dBuV/m)	(dBuV/ m)	(dB)	
Low Channel:2412MHz									
V	4824	46.55	30.55	5.77	24.66	46.43	74.00	-27.57	PK
V	4824	35.73	30.55	5.77	24.66	35.61	54.00	-18.39	AV
V	7236	47.66	30.33	6.32	24.55	48.20	74.00	-25.80	PK
V	7236	35.68	30.33	6.32	24.55	36.22	54.00	-17.78	AV
V	9648	42.60	30.85	7.45	24.69	43.89	74.00	-30.11	PK
V	9648	35.21	30.85	7.45	24.69	36.50	54.00	-17.50	AV
H	4824	46.80	30.55	5.77	24.66	46.68	74.00	-27.32	PK
H	4824	36.59	30.55	5.77	24.66	36.47	54.00	-17.53	AV
H	7236	46.19	30.33	6.32	24.55	46.73	74.00	-27.27	PK
H	7236	33.14	30.33	6.32	24.55	33.68	54.00	-20.32	AV
H	9648	42.13	30.85	7.45	24.69	43.42	74.00	-30.58	PK
H	9648	35.12	30.85	7.45	24.69	36.41	54.00	-17.59	AV

Polar (H/V)	Frequency	Meter Reading	Pre-ampl ifier	Cable Loss	Antenna Factor	Emission Level	Limits	Margin	Detect or Type
	(MHz)	(dBuV)	(dB)	(dB)	(dB)	(dBuV/m)	(dBuV/ m)	(dB)	
Middle Channel:2437MHz									
V	4874	48.68	30.55	5.77	24.66	48.56	74.00	-25.44	PK
V	4874	37.00	30.55	5.77	24.66	36.88	54.00	-17.12	AV
V	7311	47.34	30.33	6.32	24.55	47.88	74.00	-26.12	PK
V	7311	35.71	30.33	6.32	24.55	36.25	54.00	-17.75	AV
V	9748	40.79	30.85	7.45	24.69	42.08	74.00	-31.92	PK
V	9748	34.22	30.85	7.45	24.69	35.51	54.00	-18.49	AV
H	4874	45.78	30.55	5.77	24.66	45.66	74.00	-28.34	PK
H	4874	36.54	30.55	5.77	24.66	36.42	54.00	-17.58	AV
H	7311	47.63	30.33	6.32	24.55	48.17	74.00	-25.83	PK
H	7311	33.98	30.33	6.32	24.55	34.52	54.00	-19.48	AV
H	9748	42.53	30.85	7.45	24.69	43.82	74.00	-30.18	PK
H	9748	34.58	30.85	7.45	24.69	35.87	54.00	-18.13	AV

Polar (H/V)	Frequency	Meter Reading	Pre-ampl ifier	Cable Loss	Antenna Factor	Emission Level	Limits	Margin	Detect or Type
	(MHz)	(dBuV)	(dB)	(dB)	(dB)	(dBuV/m)	(dBuV/ m)	(dB)	
High Channel:2462MHz									
V	4924	46.13	30.55	5.77	24.66	46.01	74.00	-27.99	PK
V	4924	36.72	30.55	5.77	24.66	36.60	54.00	-17.40	AV
V	7386	46.29	30.33	6.32	24.55	46.83	74.00	-27.17	PK
V	7386	33.11	30.33	6.32	24.55	33.65	54.00	-20.35	AV
V	9848	41.02	30.85	7.45	24.69	42.31	74.00	-31.69	PK
V	9848	32.82	30.85	7.45	24.69	34.11	54.00	-19.89	AV
H	4924	46.66	30.55	5.77	24.66	46.54	74.00	-27.46	PK
H	4924	36.94	30.55	5.77	24.66	36.82	54.00	-17.18	AV
H	7386	45.89	30.33	6.32	24.55	46.43	74.00	-27.57	PK
H	7386	33.79	30.33	6.32	24.55	34.33	54.00	-19.67	AV
H	9848	43.02	30.85	7.45	24.69	44.31	74.00	-29.69	PK
H	9848	35.08	30.85	7.45	24.69	36.37	54.00	-17.63	AV

802.11n20-ANT1

Polar (H/V)	Frequency	Meter Reading	Pre-ampl ifier	Cable Loss	Antenna Factor	Emission Level	Limits	Margin	Detect or Type
	(MHz)	(dBuV)	(dB)	(dB)	(dB)	(dBuV/m)	(dBuV/ m)	(dB)	
Low Channel:2412MHz									
V	4824	46.13	30.55	5.77	24.66	46.01	74.00	-27.99	PK
V	4824	37.46	30.55	5.77	24.66	37.34	54.00	-16.66	AV
V	7236	46.72	30.33	6.32	24.55	47.26	74.00	-26.74	PK
V	7236	33.55	30.33	6.32	24.55	34.09	54.00	-19.91	AV
V	9648	42.09	30.85	7.45	24.69	43.38	74.00	-30.62	PK
V	9648	33.25	30.85	7.45	24.69	34.54	54.00	-19.46	AV
H	4824	47.32	30.55	5.77	24.66	47.20	74.00	-26.80	PK
H	4824	37.23	30.55	5.77	24.66	37.11	54.00	-16.89	AV
H	7236	47.30	30.33	6.32	24.55	47.84	74.00	-26.16	PK
H	7236	32.80	30.33	6.32	24.55	33.34	54.00	-20.66	AV
H	9648	42.75	30.85	7.45	24.69	44.04	74.00	-29.96	PK
H	9648	33.51	30.85	7.45	24.69	34.80	54.00	-19.20	AV

Polar (H/V)	Frequency	Meter Reading	Pre-ampl ifier	Cable Loss	Antenna Factor	Emission Level	Limits	Margin	Detect or Type
	(MHz)	(dBuV)	(dB)	(dB)	(dB)	(dBuV/m)	(dBuV/ m)	(dB)	
Middle Channel:2437MHz									
V	4874	47.99	30.55	5.77	24.66	47.87	74.00	-26.13	PK
V	4874	37.46	30.55	5.77	24.66	37.34	54.00	-16.66	AV
V	7311	46.20	30.33	6.32	24.55	46.74	74.00	-27.26	PK
V	7311	34.84	30.33	6.32	24.55	35.38	54.00	-18.62	AV
V	9748	42.82	30.85	7.45	24.69	44.11	74.00	-29.89	PK
V	9748	34.61	30.85	7.45	24.69	35.90	54.00	-18.10	AV
H	4874	48.75	30.55	5.77	24.66	48.63	74.00	-25.37	PK
H	4874	36.21	30.55	5.77	24.66	36.09	54.00	-17.91	AV
H	7311	46.12	30.33	6.32	24.55	46.66	74.00	-27.34	PK
H	7311	33.45	30.33	6.32	24.55	33.99	54.00	-20.01	AV
H	9748	40.89	30.85	7.45	24.69	42.18	74.00	-31.82	PK
H	9748	34.68	30.85	7.45	24.69	35.97	54.00	-18.03	AV

Polar (H/V)	Frequency	Meter Reading	Pre-ampl ifier	Cable Loss	Antenna Factor	Emission Level	Limits	Margin	Detect or Type
	(MHz)	(dBuV)	(dB)	(dB)	(dB)	(dBuV/m)	(dBuV/ m)	(dB)	
High Channel:2462MHz									
V	4924	48.27	30.55	5.77	24.66	48.15	74.00	-25.85	PK
V	4924	36.10	30.55	5.77	24.66	35.98	54.00	-18.02	AV
V	7386	46.28	30.33	6.32	24.55	46.82	74.00	-27.18	PK
V	7386	35.38	30.33	6.32	24.55	35.92	54.00	-18.08	AV
V	9848	43.33	30.85	7.45	24.69	44.62	74.00	-29.38	PK
V	9848	33.63	30.85	7.45	24.69	34.92	54.00	-19.08	AV
H	4924	46.00	30.55	5.77	24.66	45.88	74.00	-28.12	PK
H	4924	37.05	30.55	5.77	24.66	36.93	54.00	-17.07	AV
H	7386	47.12	30.33	6.32	24.55	47.66	74.00	-26.34	PK
H	7386	34.25	30.33	6.32	24.55	34.79	54.00	-19.21	AV
H	9848	41.05	30.85	7.45	24.69	42.34	74.00	-31.66	PK
H	9848	33.54	30.85	7.45	24.69	34.83	54.00	-19.17	AV

802.11n40-ANT1

Polar (H/V)	Frequency	Meter Reading	Pre-ampl ifier	Cable Loss	Antenna Factor	Emission Level	Limits	Margin	Detect or Type
	(MHz)	(dBuV)	(dB)	(dB)	(dB)	(dBuV/m)	(dBuV/ m)	(dB)	
Low Channel:2422MHz									
V	4844	47.65	30.55	5.77	24.66	47.53	74.00	-26.47	PK
V	4844	37.48	30.55	5.77	24.66	37.36	54.00	-16.64	AV
V	7266	46.18	30.33	6.32	24.55	46.72	74.00	-27.28	PK
V	7266	34.25	30.33	6.32	24.55	34.79	54.00	-19.21	AV
V	9688	43.48	30.85	7.45	24.69	44.77	74.00	-29.23	PK
V	9688	32.36	30.85	7.45	24.69	33.65	54.00	-20.35	AV
H	4844	46.66	30.55	5.77	24.66	46.54	74.00	-27.46	PK
H	4844	37.90	30.55	5.77	24.66	37.78	54.00	-16.22	AV
H	7266	47.52	30.33	6.32	24.55	48.06	74.00	-25.94	PK
H	7266	33.87	30.33	6.32	24.55	34.41	54.00	-19.59	AV
H	9688	43.64	30.85	7.45	24.69	44.93	74.00	-29.07	PK
H	9688	33.58	30.85	7.45	24.69	34.87	54.00	-19.13	AV

Polar (H/V)	Frequency	Meter Reading	Pre-ampl ifier	Cable Loss	Antenna Factor	Emission Level	Limits	Margin	Detect or Type
	(MHz)	(dBuV)	(dB)	(dB)	(dB)	(dBuV/m)	(dBuV/ m)	(dB)	
Middle Channel:2437MHz									
V	4874	47.01	30.55	5.77	24.66	46.89	74.00	-27.11	PK
V	4874	37.77	30.55	5.77	24.66	37.65	54.00	-16.35	AV
V	7311	47.13	30.33	6.32	24.55	47.67	74.00	-26.33	PK
V	7311	35.29	30.33	6.32	24.55	35.83	54.00	-18.17	AV
V	9748	41.44	30.85	7.45	24.69	42.73	74.00	-31.27	PK
V	9748	32.33	30.85	7.45	24.69	33.62	54.00	-20.38	AV
H	4874	47.89	30.55	5.77	24.66	47.77	74.00	-26.23	PK
H	4874	36.39	30.55	5.77	24.66	36.27	54.00	-17.73	AV
H	7311	47.75	30.33	6.32	24.55	48.29	74.00	-25.71	PK
H	7311	35.01	30.33	6.32	24.55	35.55	54.00	-18.45	AV
H	9748	43.18	30.85	7.45	24.69	44.47	74.00	-29.53	PK
H	9748	33.26	30.85	7.45	24.69	34.55	54.00	-19.45	AV

Polar (H/V)	Frequency	Meter Reading	Pre-ampl ifier	Cable Loss	Antenna Factor	Emission Level	Limits	Margin	Detect or Type
	(MHz)	(dBuV)	(dB)	(dB)	(dB)	(dBuV/m)	(dBuV/ m)	(dB)	
High Channel:2452MHz									
V	4904	46.92	30.55	5.77	24.66	46.80	74.00	-27.20	PK
V	4904	36.96	30.55	5.77	24.66	36.84	54.00	-17.16	AV
V	7356	46.92	30.33	6.32	24.55	47.46	74.00	-26.54	PK
V	7356	33.98	30.33	6.32	24.55	34.52	54.00	-19.48	AV
V	9808	43.36	30.85	7.45	24.69	44.65	74.00	-29.35	PK
V	9808	32.62	30.85	7.45	24.69	33.91	54.00	-20.09	AV
H	4904	47.30	30.55	5.77	24.66	47.18	74.00	-26.82	PK
H	4904	36.36	30.55	5.77	24.66	36.24	54.00	-17.76	AV
H	7356	46.30	30.33	6.32	24.55	46.84	74.00	-27.16	PK
H	7356	33.43	30.33	6.32	24.55	33.97	54.00	-20.03	AV
H	9808	42.75	30.85	7.45	24.69	44.04	74.00	-29.96	PK
H	9808	32.69	30.85	7.45	24.69	33.98	54.00	-20.02	AV

802.11b-ANT2

Polar (H/V)	Frequency	Meter Reading	Pre-ampl ifier	Cable Loss	Antenna Factor	Emission Level	Limits	Margin	Detect or Type
	(MHz)	(dBuV)	(dB)	(dB)	(dB)	(dBuV/m)	(dBuV/ m)	(dB)	
Low Channel:2412MHz									
V	4824	47.54	30.55	5.77	24.66	47.42	74.00	-26.58	PK
V	4824	35.99	30.55	5.77	24.66	35.87	54.00	-18.13	AV
V	7236	46.91	30.33	6.32	24.55	47.45	74.00	-26.55	PK
V	7236	35.47	30.33	6.32	24.55	36.01	54.00	-17.99	AV
V	9648	42.51	30.85	7.45	24.69	43.80	74.00	-30.20	PK
V	9648	33.14	30.85	7.45	24.69	34.43	54.00	-19.57	AV
H	4824	48.49	30.55	5.77	24.66	48.37	74.00	-25.63	PK
H	4824	37.05	30.55	5.77	24.66	36.93	54.00	-17.07	AV
H	7236	47.02	30.33	6.32	24.55	47.56	74.00	-26.44	PK
H	7236	35.39	30.33	6.32	24.55	35.93	54.00	-18.07	AV
H	9648	42.06	30.85	7.45	24.69	43.35	74.00	-30.65	PK
H	9648	33.41	30.85	7.45	24.69	34.70	54.00	-19.30	AV

Polar (H/V)	Frequency	Meter Reading	Pre-ampl ifier	Cable Loss	Antenna Factor	Emission Level	Limits	Margin	Detect or Type
	(MHz)	(dBuV)	(dB)	(dB)	(dB)	(dBuV/m)	(dBuV/ m)	(dB)	
Middle Channel:2437MHz									
V	4874	48.00	30.55	5.77	24.66	47.88	74.00	-26.12	PK
V	4874	35.50	30.55	5.77	24.66	35.38	54.00	-18.62	AV
V	7311	47.55	30.33	6.32	24.55	48.09	74.00	-25.91	PK
V	7311	35.45	30.33	6.32	24.55	35.99	54.00	-18.01	AV
V	9748	40.98	30.85	7.45	24.69	42.27	74.00	-31.73	PK
V	9748	34.14	30.85	7.45	24.69	35.43	54.00	-18.57	AV
H	4874	48.51	30.55	5.77	24.66	48.39	74.00	-25.61	PK
H	4874	37.42	30.55	5.77	24.66	37.30	54.00	-16.70	AV
H	7311	45.95	30.33	6.32	24.55	46.49	74.00	-27.51	PK
H	7311	34.23	30.33	6.32	24.55	34.77	54.00	-19.23	AV
H	9748	43.17	30.85	7.45	24.69	44.46	74.00	-29.54	PK
H	9748	33.94	30.85	7.45	24.69	35.23	54.00	-18.77	AV

Polar (H/V)	Frequency	Meter Reading	Pre-ampl ifier	Cable Loss	Antenna Factor	Emission Level	Limits	Margin	Detect or Type
	(MHz)	(dBuV)	(dB)	(dB)	(dB)	(dBuV/m)	(dBuV/ m)	(dB)	
High Channel:2462MHz									
V	4924	47.27	30.55	5.77	24.66	47.15	74.00	-26.85	PK
V	4924	37.60	30.55	5.77	24.66	37.48	54.00	-16.52	AV
V	7386	47.12	30.33	6.32	24.55	47.66	74.00	-26.34	PK
V	7386	34.68	30.33	6.32	24.55	35.22	54.00	-18.78	AV
V	9848	42.49	30.85	7.45	24.69	43.78	74.00	-30.22	PK
V	9848	33.63	30.85	7.45	24.69	34.92	54.00	-19.08	AV
H	4924	46.39	30.55	5.77	24.66	46.27	74.00	-27.73	PK
H	4924	36.90	30.55	5.77	24.66	36.78	54.00	-17.22	AV
H	7386	47.71	30.33	6.32	24.55	48.25	74.00	-25.75	PK
H	7386	34.26	30.33	6.32	24.55	34.80	54.00	-19.20	AV
H	9848	42.32	30.85	7.45	24.69	43.61	74.00	-30.39	PK
H	9848	32.66	30.85	7.45	24.69	33.95	54.00	-20.05	AV

802.11g-ANT2

Polar (H/V)	Frequency	Meter Reading	Pre-ampl ifier	Cable Loss	Antenna Factor	Emission Level	Limits	Margin	Detect or Type
	(MHz)	(dBuV)	(dB)	(dB)	(dB)	(dBuV/m)	(dBuV/ m)	(dB)	
Low Channel:2412MHz									
V	4824	46.09	30.55	5.77	24.66	45.97	74.00	-28.03	PK
V	4824	37.23	30.55	5.77	24.66	37.11	54.00	-16.89	AV
V	7236	47.74	30.33	6.32	24.55	48.28	74.00	-25.72	PK
V	7236	35.36	30.33	6.32	24.55	35.90	54.00	-18.10	AV
V	9648	41.10	30.85	7.45	24.69	42.39	74.00	-31.61	PK
V	9648	34.21	30.85	7.45	24.69	35.50	54.00	-18.50	AV
H	4824	47.20	30.55	5.77	24.66	47.08	74.00	-26.92	PK
H	4824	37.76	30.55	5.77	24.66	37.64	54.00	-16.36	AV
H	7236	46.36	30.33	6.32	24.55	46.90	74.00	-27.10	PK
H	7236	32.80	30.33	6.32	24.55	33.34	54.00	-20.66	AV
H	9648	42.50	30.85	7.45	24.69	43.79	74.00	-30.21	PK
H	9648	34.03	30.85	7.45	24.69	35.32	54.00	-18.68	AV

Polar (H/V)	Frequency	Meter Reading	Pre-ampl ifier	Cable Loss	Antenna Factor	Emission Level	Limits	Margin	Detect or Type
	(MHz)	(dBuV)	(dB)	(dB)	(dB)	(dBuV/m)	(dBuV/ m)	(dB)	
Middle Channel:2437MHz									
V	4874	47.11	30.55	5.77	24.66	46.99	74.00	-27.01	PK
V	4874	35.45	30.55	5.77	24.66	35.33	54.00	-18.67	AV
V	7311	47.44	30.33	6.32	24.55	47.98	74.00	-26.02	PK
V	7311	35.30	30.33	6.32	24.55	35.84	54.00	-18.16	AV
V	9748	43.47	30.85	7.45	24.69	44.76	74.00	-29.24	PK
V	9748	33.47	30.85	7.45	24.69	34.76	54.00	-19.24	AV
H	4874	46.97	30.55	5.77	24.66	46.85	74.00	-27.15	PK
H	4874	35.97	30.55	5.77	24.66	35.85	54.00	-18.15	AV
H	7311	47.76	30.33	6.32	24.55	48.30	74.00	-25.70	PK
H	7311	34.16	30.33	6.32	24.55	34.70	54.00	-19.30	AV
H	9748	43.28	30.85	7.45	24.69	44.57	74.00	-29.43	PK
H	9748	32.77	30.85	7.45	24.69	34.06	54.00	-19.94	AV

Polar (H/V)	Frequency	Meter Reading	Pre-ampl ifier	Cable Loss	Antenna Factor	Emission Level	Limits	Margin	Detect or Type
	(MHz)	(dBuV)	(dB)	(dB)	(dB)	(dBuV/m)	(dBuV/ m)	(dB)	
High Channel:2462MHz									
V	4924	46.10	30.55	5.77	24.66	45.98	74.00	-28.02	PK
V	4924	36.94	30.55	5.77	24.66	36.82	54.00	-17.18	AV
V	7386	47.68	30.33	6.32	24.55	48.22	74.00	-25.78	PK
V	7386	34.42	30.33	6.32	24.55	34.96	54.00	-19.04	AV
V	9848	43.34	30.85	7.45	24.69	44.63	74.00	-29.37	PK
V	9848	32.57	30.85	7.45	24.69	33.86	54.00	-20.14	AV
H	4924	47.05	30.55	5.77	24.66	46.93	74.00	-27.07	PK
H	4924	36.98	30.55	5.77	24.66	36.86	54.00	-17.14	AV
H	7386	47.26	30.33	6.32	24.55	47.80	74.00	-26.20	PK
H	7386	33.82	30.33	6.32	24.55	34.36	54.00	-19.64	AV
H	9848	40.93	30.85	7.45	24.69	42.22	74.00	-31.78	PK
H	9848	35.23	30.85	7.45	24.69	36.52	54.00	-17.48	AV

802.11n-ANT2

Polar (H/V)	Frequency	Meter Reading	Pre-ampl ifier	Cable Loss	Antenna Factor	Emission Level	Limits	Margin	Detect or Type
	(MHz)	(dBuV)	(dB)	(dB)	(dB)	(dBuV/m)	(dBuV/ m)	(dB)	
Low Channel:2412MHz									
V	4824	47.50	30.55	5.77	24.66	47.38	74.00	-26.62	PK
V	4824	35.42	30.55	5.77	24.66	35.30	54.00	-18.70	AV
V	7236	47.47	30.33	6.32	24.55	48.01	74.00	-25.99	PK
V	7236	35.71	30.33	6.32	24.55	36.25	54.00	-17.75	AV
V	9648	41.07	30.85	7.45	24.69	42.36	74.00	-31.64	PK
V	9648	35.24	30.85	7.45	24.69	36.53	54.00	-17.47	AV
H	4824	46.25	30.55	5.77	24.66	46.13	74.00	-27.87	PK
H	4824	36.72	30.55	5.77	24.66	36.60	54.00	-17.40	AV
H	7236	47.33	30.33	6.32	24.55	47.87	74.00	-26.13	PK
H	7236	32.94	30.33	6.32	24.55	33.48	54.00	-20.52	AV
H	9648	42.20	30.85	7.45	24.69	43.49	74.00	-30.51	PK
H	9648	32.28	30.85	7.45	24.69	33.57	54.00	-20.43	AV

Polar (H/V)	Frequency	Meter Reading	Pre-ampl ifier	Cable Loss	Antenna Factor	Emission Level	Limits	Margin	Detect or Type
	(MHz)	(dBuV)	(dB)	(dB)	(dB)	(dBuV/m)	(dBuV/ m)	(dB)	
Middle Channel:2437MHz									
V	4874	47.37	30.55	5.77	24.66	47.25	74.00	-26.75	PK
V	4874	35.82	30.55	5.77	24.66	35.70	54.00	-18.30	AV
V	7311	46.06	30.33	6.32	24.55	46.60	74.00	-27.40	PK
V	7311	33.20	30.33	6.32	24.55	33.74	54.00	-20.26	AV
V	9748	43.72	30.85	7.45	24.69	45.01	74.00	-28.99	PK
V	9748	33.43	30.85	7.45	24.69	34.72	54.00	-19.28	AV
H	4874	47.07	30.55	5.77	24.66	46.95	74.00	-27.05	PK
H	4874	36.53	30.55	5.77	24.66	36.41	54.00	-17.59	AV
H	7311	47.26	30.33	6.32	24.55	47.80	74.00	-26.20	PK
H	7311	34.58	30.33	6.32	24.55	35.12	54.00	-18.88	AV
H	9748	41.83	30.85	7.45	24.69	43.12	74.00	-30.88	PK
H	9748	33.46	30.85	7.45	24.69	34.75	54.00	-19.25	AV

Polar (H/V)	Frequency	Meter Reading	Pre-ampl ifier	Cable Loss	Antenna Factor	Emission Level	Limits	Margin	Detect or Type
	(MHz)	(dBuV)	(dB)	(dB)	(dB)	(dBuV/m)	(dBuV/ m)	(dB)	
High Channel:2462MHz									
V	4924	46.94	30.55	5.77	24.66	46.82	74.00	-27.18	PK
V	4924	38.15	30.55	5.77	24.66	38.03	54.00	-15.97	AV
V	7386	45.88	30.33	6.32	24.55	46.42	74.00	-27.58	PK
V	7386	34.37	30.33	6.32	24.55	34.91	54.00	-19.09	AV
V	9848	41.37	30.85	7.45	24.69	42.66	74.00	-31.34	PK
V	9848	35.19	30.85	7.45	24.69	36.48	54.00	-17.52	AV
H	4924	47.64	30.55	5.77	24.66	47.52	74.00	-26.48	PK
H	4924	36.84	30.55	5.77	24.66	36.72	54.00	-17.28	AV
H	7386	47.51	30.33	6.32	24.55	48.05	74.00	-25.95	PK
H	7386	33.13	30.33	6.32	24.55	33.67	54.00	-20.33	AV
H	9848	43.56	30.85	7.45	24.69	44.85	74.00	-29.15	PK
H	9848	34.31	30.85	7.45	24.69	35.60	54.00	-18.40	AV

802.11n40-ANT2

Polar (H/V)	Frequency	Meter Reading	Pre-ampl ifier	Cable Loss	Antenna Factor	Emission Level	Limits	Margin	Detect or Type
	(MHz)	(dBuV)	(dB)	(dB)	(dB)	(dBuV/m)	(dBuV/ m)	(dB)	
Low Channel:2422MHz									
V	4844	47.75	30.55	5.77	24.66	47.63	74.00	-26.37	PK
V	4844	36.84	30.55	5.77	24.66	36.72	54.00	-17.28	AV
V	7266	47.23	30.33	6.32	24.55	47.77	74.00	-26.23	PK
V	7266	33.07	30.33	6.32	24.55	33.61	54.00	-20.39	AV
V	9688	41.85	30.85	7.45	24.69	43.14	74.00	-30.86	PK
V	9688	34.36	30.85	7.45	24.69	35.65	54.00	-18.35	AV
H	4844	48.22	30.55	5.77	24.66	48.10	74.00	-25.90	PK
H	4844	37.31	30.55	5.77	24.66	37.19	54.00	-16.81	AV
H	7266	47.76	30.33	6.32	24.55	48.30	74.00	-25.70	PK
H	7266	35.52	30.33	6.32	24.55	36.06	54.00	-17.94	AV
H	9688	43.13	30.85	7.45	24.69	44.42	74.00	-29.58	PK
H	9688	35.09	30.85	7.45	24.69	36.38	54.00	-17.62	AV

Polar (H/V)	Frequency	Meter Reading	Pre-ampl ifier	Cable Loss	Antenna Factor	Emission Level	Limits	Margin	Detect or Type
	(MHz)	(dBuV)	(dB)	(dB)	(dB)	(dBuV/m)	(dBuV/ m)	(dB)	
Middle Channel:2437MHz									
V	4874	48.14	30.55	5.77	24.66	48.02	74.00	-25.98	PK
V	4874	37.82	30.55	5.77	24.66	37.70	54.00	-16.30	AV
V	7311	45.97	30.33	6.32	24.55	46.51	74.00	-27.49	PK
V	7311	34.18	30.33	6.32	24.55	34.72	54.00	-19.28	AV
V	9748	41.01	30.85	7.45	24.69	42.30	74.00	-31.70	PK
V	9748	33.03	30.85	7.45	24.69	34.32	54.00	-19.68	AV
H	4874	47.43	30.55	5.77	24.66	47.31	74.00	-26.69	PK
H	4874	35.24	30.55	5.77	24.66	35.12	54.00	-18.88	AV
H	7311	46.65	30.33	6.32	24.55	47.19	74.00	-26.81	PK
H	7311	32.92	30.33	6.32	24.55	33.46	54.00	-20.54	AV
H	9748	41.09	30.85	7.45	24.69	42.38	74.00	-31.62	PK
H	9748	33.53	30.85	7.45	24.69	34.82	54.00	-19.18	AV

Polar (H/V)	Frequency	Meter Reading	Pre-ampl ifier	Cable Loss	Antenna Factor	Emission Level	Limits	Margin	Detect or Type
	(MHz)	(dBuV)	(dB)	(dB)	(dB)	(dBuV/m)	(dBuV/ m)	(dB)	
High Channel:2452MHz									
V	4904	48.08	30.55	5.77	24.66	47.96	74.00	-26.04	PK
V	4904	35.50	30.55	5.77	24.66	35.38	54.00	-18.62	AV
V	7356	46.65	30.33	6.32	24.55	47.19	74.00	-26.81	PK
V	7356	32.93	30.33	6.32	24.55	33.47	54.00	-20.53	AV
V	9808	42.96	30.85	7.45	24.69	44.25	74.00	-29.75	PK
V	9808	33.69	30.85	7.45	24.69	34.98	54.00	-19.02	AV
H	4904	48.38	30.55	5.77	24.66	48.26	74.00	-25.74	PK
H	4904	38.07	30.55	5.77	24.66	37.95	54.00	-16.05	AV
H	7356	46.62	30.33	6.32	24.55	47.16	74.00	-26.84	PK
H	7356	34.55	30.33	6.32	24.55	35.09	54.00	-18.91	AV
H	9808	40.93	30.85	7.45	24.69	42.22	74.00	-31.78	PK
H	9808	33.86	30.85	7.45	24.69	35.15	54.00	-18.85	AV

MIMO-802.11n

Polar (H/V)	Frequency	Meter Reading	Pre-ampl ifier	Cable Loss	Antenna Factor	Emission Level	Limits	Margin	Detect or Type
	(MHz)	(dBuV)	(dB)	(dB)	(dB)	(dBuV/m)	(dBuV/ m)	(dB)	
Low Channel:2412MHz									
V	4824	45.85	30.55	5.77	24.66	45.73	74.00	-28.27	PK
V	4824	37.54	30.55	5.77	24.66	37.42	54.00	-16.58	AV
V	7236	47.01	30.33	6.32	24.55	47.55	74.00	-26.45	PK
V	7236	35.66	30.33	6.32	24.55	36.20	54.00	-17.80	AV
V	9648	41.73	30.85	7.45	24.69	43.02	74.00	-30.98	PK
V	9648	34.38	30.85	7.45	24.69	35.67	54.00	-18.33	AV
H	4824	48.10	30.55	5.77	24.66	47.98	74.00	-26.02	PK
H	4824	37.16	30.55	5.77	24.66	37.04	54.00	-16.96	AV
H	7236	46.99	30.33	6.32	24.55	47.53	74.00	-26.47	PK
H	7236	34.55	30.33	6.32	24.55	35.09	54.00	-18.91	AV
H	9648	41.51	30.85	7.45	24.69	42.80	74.00	-31.20	PK
H	9648	33.81	30.85	7.45	24.69	35.10	54.00	-18.90	AV

Polar (H/V)	Frequency	Meter Reading	Pre-ampl ifier	Cable Loss	Antenna Factor	Emission Level	Limits	Margin	Detect or Type
	(MHz)	(dBuV)	(dB)	(dB)	(dB)	(dBuV/m)	(dBuV/ m)	(dB)	
Middle Channel:2437MHz									
V	4874	47.80	30.55	5.77	24.66	47.68	74.00	-26.32	PK
V	4874	36.11	30.55	5.77	24.66	35.99	54.00	-18.01	AV
V	7311	47.33	30.33	6.32	24.55	47.87	74.00	-26.13	PK
V	7311	32.92	30.33	6.32	24.55	33.46	54.00	-20.54	AV
V	9748	43.61	30.85	7.45	24.69	44.90	74.00	-29.10	PK
V	9748	34.85	30.85	7.45	24.69	36.14	54.00	-17.86	AV
H	4874	47.64	30.55	5.77	24.66	47.52	74.00	-26.48	PK
H	4874	36.95	30.55	5.77	24.66	36.83	54.00	-17.17	AV
H	7311	45.98	30.33	6.32	24.55	46.52	74.00	-27.48	PK
H	7311	35.14	30.33	6.32	24.55	35.68	54.00	-18.32	AV
H	9748	40.92	30.85	7.45	24.69	42.21	74.00	-31.79	PK
H	9748	34.72	30.85	7.45	24.69	36.01	54.00	-17.99	AV

Polar (H/V)	Frequency	Meter Reading	Pre-ampl ifier	Cable Loss	Antenna Factor	Emission Level	Limits	Margin	Detect or Type
	(MHz)	(dBuV)	(dB)	(dB)	(dB)	(dBuV/m)	(dBuV/ m)	(dB)	
High Channel:2462MHz									
V	4924	47.78	30.55	5.77	24.66	47.66	74.00	-26.34	PK
V	4924	36.27	30.55	5.77	24.66	36.15	54.00	-17.85	AV
V	7386	46.90	30.33	6.32	24.55	47.44	74.00	-26.56	PK
V	7386	35.62	30.33	6.32	24.55	36.16	54.00	-17.84	AV
V	9848	43.20	30.85	7.45	24.69	44.49	74.00	-29.51	PK
V	9848	34.93	30.85	7.45	24.69	36.22	54.00	-17.78	AV
H	4924	47.23	30.55	5.77	24.66	47.11	74.00	-26.89	PK
H	4924	37.17	30.55	5.77	24.66	37.05	54.00	-16.95	AV
H	7386	46.41	30.33	6.32	24.55	46.95	74.00	-27.05	PK
H	7386	34.26	30.33	6.32	24.55	34.80	54.00	-19.20	AV
H	9848	42.09	30.85	7.45	24.69	43.38	74.00	-30.62	PK
H	9848	34.42	30.85	7.45	24.69	35.71	54.00	-18.29	AV

MIMO-802.11n40

Polar (H/V)	Frequency	Meter Reading	Pre-ampl ifier	Cable Loss	Antenna Factor	Emission Level	Limits	Margin	Detect or Type
	(MHz)	(dBuV)	(dB)	(dB)	(dB)	(dBuV/m)	(dBuV/ m)	(dB)	
Low Channel:2422MHz									
V	4844	45.88	30.55	5.77	24.66	45.76	74.00	-28.24	PK
V	4844	35.61	30.55	5.77	24.66	35.49	54.00	-18.51	AV
V	7266	46.47	30.33	6.32	24.55	47.01	74.00	-26.99	PK
V	7266	33.20	30.33	6.32	24.55	33.74	54.00	-20.26	AV
V	9688	42.71	30.85	7.45	24.69	44.00	74.00	-30.00	PK
V	9688	32.25	30.85	7.45	24.69	33.54	54.00	-20.46	AV
H	4844	48.55	30.55	5.77	24.66	48.43	74.00	-25.57	PK
H	4844	36.11	30.55	5.77	24.66	35.99	54.00	-18.01	AV
H	7266	45.92	30.33	6.32	24.55	46.46	74.00	-27.54	PK
H	7266	33.29	30.33	6.32	24.55	33.83	54.00	-20.17	AV
H	9688	41.78	30.85	7.45	24.69	43.07	74.00	-30.93	PK
H	9688	32.39	30.85	7.45	24.69	33.68	54.00	-20.32	AV

Polar (H/V)	Frequency	Meter Reading	Pre-ampl ifier	Cable Loss	Antenna Factor	Emission Level	Limits	Margin	Detect or Type
	(MHz)	(dBuV)	(dB)	(dB)	(dB)	(dBuV/m)	(dBuV/ m)	(dB)	
Middle Channel:2437MHz									
V	4874	46.39	30.55	5.77	24.66	46.27	74.00	-27.73	PK
V	4874	37.45	30.55	5.77	24.66	37.33	54.00	-16.67	AV
V	7311	47.02	30.33	6.32	24.55	47.56	74.00	-26.44	PK
V	7311	33.51	30.33	6.32	24.55	34.05	54.00	-19.95	AV
V	9748	40.94	30.85	7.45	24.69	42.23	74.00	-31.77	PK
V	9748	33.65	30.85	7.45	24.69	34.94	54.00	-19.06	AV
H	4874	47.86	30.55	5.77	24.66	47.74	74.00	-26.26	PK
H	4874	37.11	30.55	5.77	24.66	36.99	54.00	-17.01	AV
H	7311	46.04	30.33	6.32	24.55	46.58	74.00	-27.42	PK
H	7311	33.35	30.33	6.32	24.55	33.89	54.00	-20.11	AV
H	9748	43.22	30.85	7.45	24.69	44.51	74.00	-29.49	PK
H	9748	33.85	30.85	7.45	24.69	35.14	54.00	-18.86	AV

Polar (H/V)	Frequency	Meter Reading	Pre-ampl ifier	Cable Loss	Antenna Factor	Emission Level	Limits	Margin	Detect or Type
	(MHz)	(dBuV)	(dB)	(dB)	(dB)	(dBuV/m)	(dBuV/ m)	(dB)	
High Channel:2452MHz									
V	4904	48.64	30.55	5.77	24.66	48.52	74.00	-25.48	PK
V	4904	35.42	30.55	5.77	24.66	35.30	54.00	-18.70	AV
V	7356	46.97	30.33	6.32	24.55	47.51	74.00	-26.49	PK
V	7356	33.70	30.33	6.32	24.55	34.24	54.00	-19.76	AV
V	9808	40.78	30.85	7.45	24.69	42.07	74.00	-31.93	PK
V	9808	32.69	30.85	7.45	24.69	33.98	54.00	-20.02	AV
H	4904	48.74	30.55	5.77	24.66	48.62	74.00	-25.38	PK
H	4904	38.06	30.55	5.77	24.66	37.94	54.00	-16.06	AV
H	7356	47.03	30.33	6.32	24.55	47.57	74.00	-26.43	PK
H	7356	33.75	30.33	6.32	24.55	34.29	54.00	-19.71	AV
H	9808	42.97	30.85	7.45	24.69	44.26	74.00	-29.74	PK
H	9808	33.18	30.85	7.45	24.69	34.47	54.00	-19.53	AV

5. RADIATED BAND EMISSION MEASUREMENT

5.1 TEST REQUIREMENT:

Test Requirement:	FCC Part 15 C Section 15.209 and 15.205				
Test Method:	ANSI C63.10: 2013				
Test Frequency Range:	All of the restrict bands were tested, only the worst band's (2310MHz to 2500MHz) data was showed.				
Test site:	Measurement Distance: 3m				
Receiver setup:	Frequency	Detector	RBW	VBW	Value
	Above 1GHz	Peak	1MHz	3MHz	Peak
		Average	1MHz	3MHz	Average

LIMITS OF RADIATED EMISSION MEASUREMENT (Above 1000MHz)

FREQUENCY (MHz)	Class B (dBuV/m) (at 3M)	
	PEAK	AVERAGE
Above 1000	74	54

Notes:

- (1) The limit for radiated test was performed according to FCC PART 15C.
- (2) The tighter limit applies at the band edges.
- (3) Emission level (dBuV/m) = 20log Emission level (uV/m).

5.2 TEST PROCEDURE

Above 1GHz test procedure as below:

- a. 1. The EUT was placed on the top of a rotating table 1.5 meters above the ground at a 3 meter camber. The table was rotated 360 degrees to determine the position of the highest radiation.
- b. The EUT was set 3 meters away from the interference-receiving antenna, which was mounted on the top of a variable-height antenna tower.
- c. The antenna height is varied from one meter to four meters above the ground to determine the maximum value of the field strength. Both horizontal and vertical polarizations of the antenna are set to make the measurement.
- d. For each suspected emission, the EUT was arranged to its worst case and then the antenna was tuned to heights from 1 meter to 4 meters and the rota table was turned from 0 degrees to 360 degrees to find the maximum reading.
- e. The test-receiver system was set to Peak Detect Function and Specified Bandwidth with Maximum Hold Mode.
- f. If the emission level of the EUT in peak mode was 10dB lower than the limit specified, then testing could be stopped and the peak values of the EUT would be reported. Otherwise the emissions that did not have 10dB margin would be re-tested one by one using peak, quasi-peak or average method as specified and then reported in a data sheet.
- g. Test the EUT in the lowest channel, the highest channel

Note:

Both horizontal and vertical antenna polarities were tested and performed pretest to three orthogonal axis. The worst case emissions were reported

5.3 DEVIATION FROM TEST STANDARD

No deviation

5.4 TEST SETUP

Radiated Emission Test-Up Frequency Above 1GHz

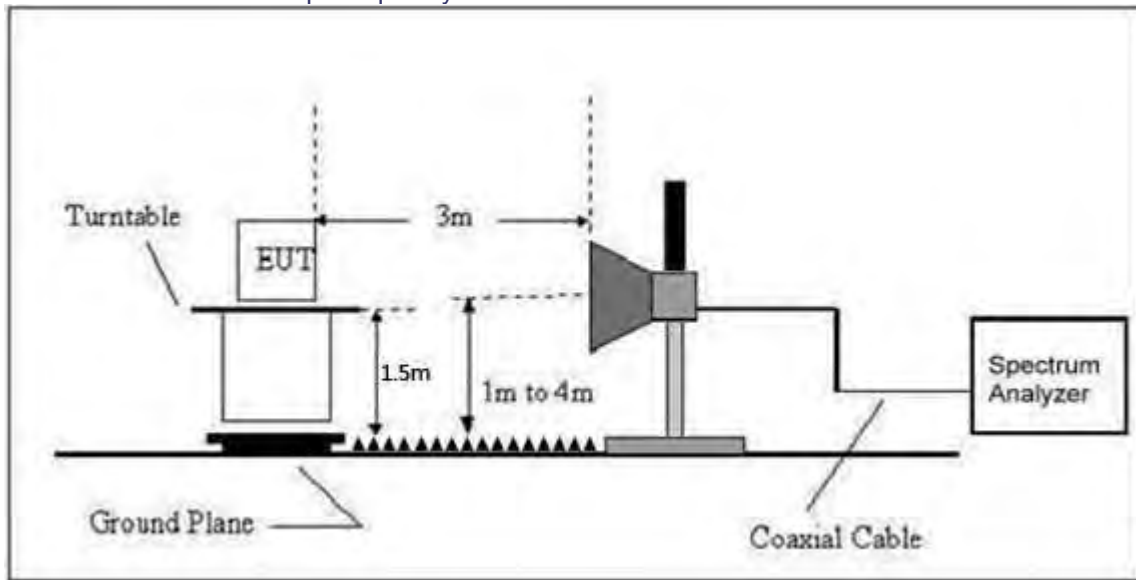

5.5 EUT OPERATING CONDITIONS

The EUT tested system was configured as the statements of 2.3 Unless otherwise a special operating condition is specified in the follows during the testing.

5.6 TEST RESULT

ANT1

	Polar (H/V)	Frequency (MHz)	Meter Reading (dBuV)	Pre-amplifier (dB)	Cable Loss (dB)	Antenna Factor (dB/m)	Emission level (dBuV/m)	Limit (dBuV/m)	Detector Type	Result
802.11b	Low Channel 2412MHz									
	H	2390.00	53.01	30.22	4.85	23.98	51.62	74	PK	PASS
	H	2390.00	35.88	30.22	4.85	23.98	34.49	54	AV	PASS
	H	2400.00	52.46	30.22	4.85	23.98	51.07	74	PK	PASS
	H	2400.00	39.96	30.22	4.85	23.98	38.57	54	AV	PASS
	V	2390.00	50.21	30.22	4.85	23.98	48.82	74	PK	PASS
	V	2390.00	41.78	30.22	4.85	23.98	40.39	54	AV	PASS
	V	2400.00	52.44	30.22	4.85	23.98	51.05	74	PK	PASS
	V	2400.00	37.31	30.22	4.85	23.98	35.92	54	AV	PASS
	High Channel 2462MHz									
	H	2483.50	48.71	30.22	4.85	23.98	47.32	74	PK	PASS
	H	2485.50	34.49	30.22	4.85	23.98	33.10	54	AV	PASS
	H	2483.50	53.39	30.22	4.85	23.98	52.00	74	PK	PASS
	H	2485.50	36.99	30.22	4.85	23.98	35.60	54	AV	PASS
	V	2483.50	51.93	30.22	4.85	23.98	50.54	74	PK	PASS
	V	2485.50	44.48	30.22	4.85	23.98	43.09	54	AV	PASS
V	2483.50	57.23	30.22	4.85	23.98	55.84	74	PK	PASS	
V	2485.50	39.91	30.22	4.85	23.98	38.52	54	AV	PASS	
802.11g	Low Channel 2412MHz									
	H	2390.00	53.25	30.22	4.85	23.98	51.86	74	PK	PASS
	H	2390.00	37.97	30.22	4.85	23.98	36.58	54	AV	PASS
	H	2400.00	54.39	30.22	4.85	23.98	53.00	74	PK	PASS
	H	2400.00	38.77	30.22	4.85	23.98	37.38	54	AV	PASS
	V	2390.00	51.84	30.22	4.85	23.98	50.45	74	PK	PASS
	V	2390.00	41.20	30.22	4.85	23.98	39.81	54	AV	PASS
	V	2400.00	51.60	30.22	4.85	23.98	50.21	74	PK	PASS
	V	2400.00	39.27	30.22	4.85	23.98	37.88	54	AV	PASS
	High Channel 2462MHz									
	H	2483.50	48.31	30.22	4.85	23.98	46.92	74	PK	PASS
	H	2485.50	37.54	30.22	4.85	23.98	36.15	54	AV	PASS
	H	2483.50	49.93	30.22	4.85	23.98	48.54	74	PK	PASS
	H	2485.50	37.50	30.22	4.85	23.98	36.11	54	AV	PASS
	V	2483.50	52.79	30.22	4.85	23.98	51.40	74	PK	PASS
	V	2485.50	39.87	30.22	4.85	23.98	38.48	54	AV	PASS
V	2483.50	58.75	30.22	4.85	23.98	57.36	74	PK	PASS	
V	2485.50	37.92	30.22	4.85	23.98	36.53	54	AV	PASS	
802.11n20	Low Channel 2412MHz									
	H	2390.00	55.41	30.22	4.85	23.98	54.02	74	PK	PASS
	H	2390.00	38.16	30.22	4.85	23.98	36.77	54	AV	PASS
	H	2400.00	53.18	30.22	4.85	23.98	51.79	74	PK	PASS
	H	2400.00	39.00	30.22	4.85	23.98	37.61	54	AV	PASS
	V	2390.00	50.58	30.22	4.85	23.98	49.19	74	PK	PASS
	V	2390.00	40.90	30.22	4.85	23.98	39.51	54	AV	PASS
	V	2400.00	53.47	30.22	4.85	23.98	52.08	74	PK	PASS
	V	2400.00	38.29	30.22	4.85	23.98	36.90	54	AV	PASS
	High Channel 2462MHz									
	H	2483.50	48.71	30.22	4.85	23.98	47.32	74	PK	PASS
	H	2485.50	37.18	30.22	4.85	23.98	35.79	54	AV	PASS
H	2483.50	53.72	30.22	4.85	23.98	52.33	74	PK	PASS	
H	2485.50	35.37	30.22	4.85	23.98	33.98	54	AV	PASS	

	V	2483.50	54.19	30.22	4.85	23.98	52.80	74	PK	PASS
	V	2485.50	40.35	30.22	4.85	23.98	38.96	54	AV	PASS
	V	2483.50	55.59	30.22	4.85	23.98	54.20	74	PK	PASS
	V	2485.50	37.38	30.22	4.85	23.98	35.99	54	AV	PASS

Remark:

1. Emission Level = Meter Reading + Antenna Factor + Cable Loss – Pre-amplifier, Margin= Emission Level - Limit

		Low Channel 2422MHz									
802.11n40	H	2390.00	52.81	30.22	4.85	23.98	51.42	74	PK	PASS	
	H	2390.00	36.57	30.22	4.85	23.98	35.18	54	AV	PASS	
	H	2400.00	51.76	30.22	4.85	23.98	50.37	74	PK	PASS	
	H	2400.00	40.43	30.22	4.85	23.98	39.04	54	AV	PASS	
	V	2390.00	53.72	30.22	4.85	23.98	52.33	74	PK	PASS	
	V	2390.00	41.74	30.22	4.85	23.98	40.35	54	AV	PASS	
	V	2400.00	51.32	30.22	4.85	23.98	49.93	74	PK	PASS	
	V	2400.00	38.73	30.22	4.85	23.98	37.34	54	AV	PASS	
			High Channel 2452MHz								
		H	2483.50	47.88	30.22	4.85	23.98	46.49	74	PK	PASS
		H	2485.50	33.89	30.22	4.85	23.98	32.50	54	AV	PASS
		H	2483.50	51.64	30.22	4.85	23.98	50.25	74	PK	PASS
		H	2485.50	34.76	30.22	4.85	23.98	33.37	54	AV	PASS
		V	2483.50	53.68	30.22	4.85	23.98	52.29	74	PK	PASS
	V	2485.50	41.49	30.22	4.85	23.98	40.10	54	AV	PASS	
	V	2483.50	58.25	30.22	4.85	23.98	56.86	74	PK	PASS	
	V	2485.50	41.69	30.22	4.85	23.98	40.30	54	AV	PASS	

Remark:

1. Emission Level = Meter Reading + Antenna Factor + Cable Loss – Pre-amplifier, Margin= Emission Level - Limit

ANT2

	Polar (H/V)	Frequency (MHz)	Meter Reading (dBuV)	Pre-amplifier (dB)	Cable Loss (dB)	Antenna Factor (dB/m)	Emission level (dBuV/m)	Limit (dBuV/m)	Detector Type	Result
802.11b	Low Channel 2412MHz									
	H	2390.00	54.91	30.22	4.85	23.98	53.52	74	PK	PASS
	H	2390.00	38.24	30.22	4.85	23.98	36.85	54	AV	PASS
	H	2400.00	54.24	30.22	4.85	23.98	52.85	74	PK	PASS
	H	2400.00	39.35	30.22	4.85	23.98	37.96	54	AV	PASS
	V	2390.00	53.04	30.22	4.85	23.98	51.65	74	PK	PASS
	V	2390.00	40.99	30.22	4.85	23.98	39.60	54	AV	PASS
	V	2400.00	53.50	30.22	4.85	23.98	52.11	74	PK	PASS
	V	2400.00	39.20	30.22	4.85	23.98	37.81	54	AV	PASS
	High Channel 2462MHz									
	H	2483.50	48.57	30.22	4.85	23.98	47.18	74	PK	PASS
	H	2485.50	35.66	30.22	4.85	23.98	34.27	54	AV	PASS
	H	2483.50	54.07	30.22	4.85	23.98	52.68	74	PK	PASS
	H	2485.50	38.54	30.22	4.85	23.98	37.15	54	AV	PASS
	V	2483.50	53.03	30.22	4.85	23.98	51.64	74	PK	PASS
	V	2485.50	38.04	30.22	4.85	23.98	36.65	54	AV	PASS
V	2483.50	54.62	30.22	4.85	23.98	53.23	74	PK	PASS	
V	2485.50	37.55	30.22	4.85	23.98	36.16	54	AV	PASS	

802.11g	Low Channel 2412MHz									
	H	2390.00	56.70	30.22	4.85	23.98	55.31	74	PK	PASS
	H	2390.00	36.58	30.22	4.85	23.98	35.19	54	AV	PASS
	H	2400.00	52.48	30.22	4.85	23.98	51.09	74	PK	PASS
	H	2400.00	38.69	30.22	4.85	23.98	37.30	54	AV	PASS
	V	2390.00	50.27	30.22	4.85	23.98	48.88	74	PK	PASS
	V	2390.00	40.91	30.22	4.85	23.98	39.52	54	AV	PASS
	V	2400.00	52.70	30.22	4.85	23.98	51.31	74	PK	PASS
	V	2400.00	39.57	30.22	4.85	23.98	38.18	54	AV	PASS
	High Channel 2462MHz									
	H	2483.50	47.15	30.22	4.85	23.98	45.76	74	PK	PASS
	H	2485.50	35.93	30.22	4.85	23.98	34.54	54	AV	PASS
	H	2483.50	51.63	30.22	4.85	23.98	50.24	74	PK	PASS
	H	2485.50	37.32	30.22	4.85	23.98	35.93	54	AV	PASS
	V	2483.50	53.81	30.22	4.85	23.98	52.42	74	PK	PASS
	V	2485.50	41.15	30.22	4.85	23.98	39.76	54	AV	PASS
V	2483.50	53.22	30.22	4.85	23.98	51.83	74	PK	PASS	
V	2485.50	38.80	30.22	4.85	23.98	37.41	54	AV	PASS	

802.11n20	Low Channel 2412MHz									
	H	2390.00	53.97	30.22	4.85	23.98	52.58	74	PK	PASS
	H	2390.00	36.25	30.22	4.85	23.98	34.86	54	AV	PASS
	H	2400.00	53.11	30.22	4.85	23.98	51.72	74	PK	PASS
	H	2400.00	38.26	30.22	4.85	23.98	36.87	54	AV	PASS
	V	2390.00	50.03	30.22	4.85	23.98	48.64	74	PK	PASS
	V	2390.00	40.01	30.22	4.85	23.98	38.62	54	AV	PASS
	V	2400.00	52.30	30.22	4.85	23.98	50.91	74	PK	PASS
	V	2400.00	37.40	30.22	4.85	23.98	36.01	54	AV	PASS
	High Channel 2462MHz									
	H	2483.50	48.26	30.22	4.85	23.98	46.87	74	PK	PASS
	H	2485.50	34.85	30.22	4.85	23.98	33.46	54	AV	PASS
H	2483.50	54.89	30.22	4.85	23.98	53.50	74	PK	PASS	
H	2485.50	35.04	30.22	4.85	23.98	33.65	54	AV	PASS	

	V	2483.50	54.29	30.22	4.85	23.98	52.90	74	PK	PASS
	V	2485.50	43.88	30.22	4.85	23.98	42.49	54	AV	PASS
	V	2483.50	54.18	30.22	4.85	23.98	52.79	74	PK	PASS
	V	2485.50	39.42	30.22	4.85	23.98	38.03	54	AV	PASS

Remark:

1. Emission Level = Meter Reading + Antenna Factor + Cable Loss – Pre-amplifier, Margin= Emission Level - Limit

802.11n40	Low Channel 2422MHz									
	H	2390.00	54.92	30.22	4.85	23.98	53.53	74	PK	PASS
	H	2390.00	36.57	30.22	4.85	23.98	35.18	54	AV	PASS
	H	2400.00	54.04	30.22	4.85	23.98	52.65	74	PK	PASS
	H	2400.00	38.54	30.22	4.85	23.98	37.15	54	AV	PASS
	V	2390.00	53.52	30.22	4.85	23.98	52.13	74	PK	PASS
	V	2390.00	40.83	30.22	4.85	23.98	39.44	54	AV	PASS
	V	2400.00	51.30	30.22	4.85	23.98	49.91	74	PK	PASS
	V	2400.00	39.50	30.22	4.85	23.98	38.11	54	AV	PASS
	High Channel 2452MHz									
	H	2483.50	49.45	30.22	4.85	23.98	48.06	74	PK	PASS
	H	2485.50	37.45	30.22	4.85	23.98	36.06	54	AV	PASS
	H	2483.50	53.40	30.22	4.85	23.98	52.01	74	PK	PASS
	H	2485.50	40.42	30.22	4.85	23.98	39.03	54	AV	PASS
	V	2483.50	54.06	30.22	4.85	23.98	52.67	74	PK	PASS
	V	2485.50	41.00	30.22	4.85	23.98	39.61	54	AV	PASS
V	2483.50	59.98	30.22	4.85	23.98	58.59	74	PK	PASS	
V	2485.50	43.32	30.22	4.85	23.98	41.93	54	AV	PASS	

Remark:

1. Emission Level = Meter Reading + Antenna Factor + Cable Loss – Pre-amplifier, Margin= Emission Level - Limit

MIMO

802.11n20	Low Channel 2412MHz									
	H	2390.00	55.02	30.22	4.85	23.98	53.63	74	PK	PASS
	H	2390.00	36.96	30.22	4.85	23.98	35.57	54	AV	PASS
	H	2400.00	53.27	30.22	4.85	23.98	51.88	74	PK	PASS
	H	2400.00	39.38	30.22	4.85	23.98	37.99	54	AV	PASS
	V	2390.00	50.98	30.22	4.85	23.98	49.59	74	PK	PASS
	V	2390.00	40.52	30.22	4.85	23.98	39.13	54	AV	PASS
	V	2400.00	53.48	30.22	4.85	23.98	52.09	74	PK	PASS
	V	2400.00	39.35	30.22	4.85	23.98	37.96	54	AV	PASS
	High Channel 2462MHz									
	H	2483.50	49.96	30.22	4.85	23.98	48.57	74	PK	PASS
	H	2485.50	39.13	30.22	4.85	23.98	37.74	54	AV	PASS
	H	2483.50	48.80	30.22	4.85	23.98	47.41	74	PK	PASS
	H	2485.50	38.21	30.22	4.85	23.98	36.82	54	AV	PASS
	V	2483.50	59.02	30.22	4.85	23.98	57.63	74	PK	PASS
	V	2485.50	43.72	30.22	4.85	23.98	42.33	54	AV	PASS
V	2483.50	60.75	30.22	4.85	23.98	59.36	74	PK	PASS	
V	2485.50	37.93	30.22	4.85	23.98	36.54	54	AV	PASS	

Remark:

1. Emission Level = Meter Reading + Antenna Factor + Cable Loss – Pre-amplifier, Margin= Emission Level - Limit

		Low Channel 2422MHz										
		H	2390.00	54.67	30.22	4.85	23.98	53.28	74	PK	PASS	
802.11n40		H	2390.00	37.37	30.22	4.85	23.98	35.98	54	AV	PASS	
		H	2400.00	51.98	30.22	4.85	23.98	50.59	74	PK	PASS	
		H	2400.00	40.31	30.22	4.85	23.98	38.92	54	AV	PASS	
		V	2390.00	51.49	30.22	4.85	23.98	50.10	74	PK	PASS	
		V	2390.00	41.44	30.22	4.85	23.98	40.05	54	AV	PASS	
		V	2400.00	50.84	30.22	4.85	23.98	49.45	74	PK	PASS	
		V	2400.00	38.67	30.22	4.85	23.98	37.28	54	AV	PASS	
			High Channel 2452MHz									
			H	2483.50	48.25	30.22	4.85	23.98	46.86	74	PK	PASS
			H	2485.50	35.43	30.22	4.85	23.98	34.04	54	AV	PASS
			H	2483.50	47.77	30.22	4.85	23.98	46.38	74	PK	PASS
			H	2485.50	39.05	30.22	4.85	23.98	37.66	54	AV	PASS
			V	2483.50	57.69	30.22	4.85	23.98	56.30	74	PK	PASS
			V	2485.50	43.37	30.22	4.85	23.98	41.98	54	AV	PASS
		V	2483.50	53.96	30.22	4.85	23.98	52.57	74	PK	PASS	
		V	2485.50	41.51	30.22	4.85	23.98	40.12	54	AV	PASS	

Remark:

1. Emission Level = Meter Reading + Antenna Factor + Cable Loss – Pre-amplifier, Margin= Emission Level - Limit

6. POWER SPECTRAL DENSITY TEST

Test Requirement:	FCC Part15 C Section 15.247 (e)
Test Method:	KDB558074 D0115.247 Meas Guidance v 05r02

6.1 APPLIED PROCEDURES / LIMIT

FCC Part15 (15.247) , Subpart C				
Section	Test Item	Limit	Frequency Range (MHz)	Result
15.247	Power Spectral Density	8dBm/3kHz	2400-2483.5	PASS

6.2 TEST PROCEDURE

1. Set analyzer center frequency to DTS channel center frequency.
2. Set the span to 1.5 times the DTS bandwidth.
3. Set the RBW to: $3 \text{ kHz} \leq \text{RBW} \leq 100 \text{ kHz}$.
4. Set the VBW $\geq 3 \times \text{RBW}$.
5. Detector = peak.
6. Sweep time = auto couple.
7. Trace mode = max hold.
8. Allow trace to fully stabilize.
9. Use the peak marker function to determine the maximum amplitude level within the RBW.
10. If measured value exceeds limit, reduce RBW (no less than 3 kHz) and repeat.

6.3 DEVIATION FROM STANDARD

No deviation.

6.4 TEST SETUP



6.5 EUT OPERATION CONDITIONS

The EUT tested system was configured as the statements of 2.1 Unless otherwise a special operating condition is specified in the follows during the testing.

6.6 TEST RESULT

Temperature :	26°C	Relative Humidity :	54%
Pressure :	101kPa	Test Voltage :	DC5.0V

Test mode	Test channel	Power Spectral Density (dBm/3kHz)			Limit:	Result
		ANT1	ANT2	SUM		
802.11b	Lowest	-6.83	-6.87	/	8dBm/3kHz	PASS
	Middle	-7.10	-7.62	/		
	Highest	-7.94	-8.33	/		
802.11g	Lowest	-12.42	-12.42	/	8dBm/3kHz	PASS
	Middle	-13.25	-13.63	/		
	Highest	-14.42	-14.91	/		
802.11n(HT20)	Lowest	-11.93	-11.40	-8.65	8dBm/3kHz	PASS
	Middle	-12.30	-12.43	-9.35		
	Highest	-13.51	-14.04	-10.76		
802.11n(HT40)	Lowest	-14.04	-13.97	-10.99	8dBm/3kHz	PASS
	Middle	-15.12	-14.40	-11.73		
	Highest	-15.57	-15.06	-12.30		

Remark:

1. Measured peak power spectrum density at difference data rate for each mode and recorded worst case for each mode.
2. Test results including cable loss;
3. Please refer to following plots;
4. The PSD limits of IEEE 802.11n HT20 and IEEE 802.11 n HT40 for MIMO with CDD technology should be reduce $10 \cdot \log(2) = 3.010\text{dBi}$ according to KDB662911D01;
5. For MIMO with CCD technology device, The Directional Gain= Gain of individual transmit antennas (dBi) + Array gain;
Array gain = $10 \log(N_{ant})$, where N_{ant} is the number of transmit antennas.

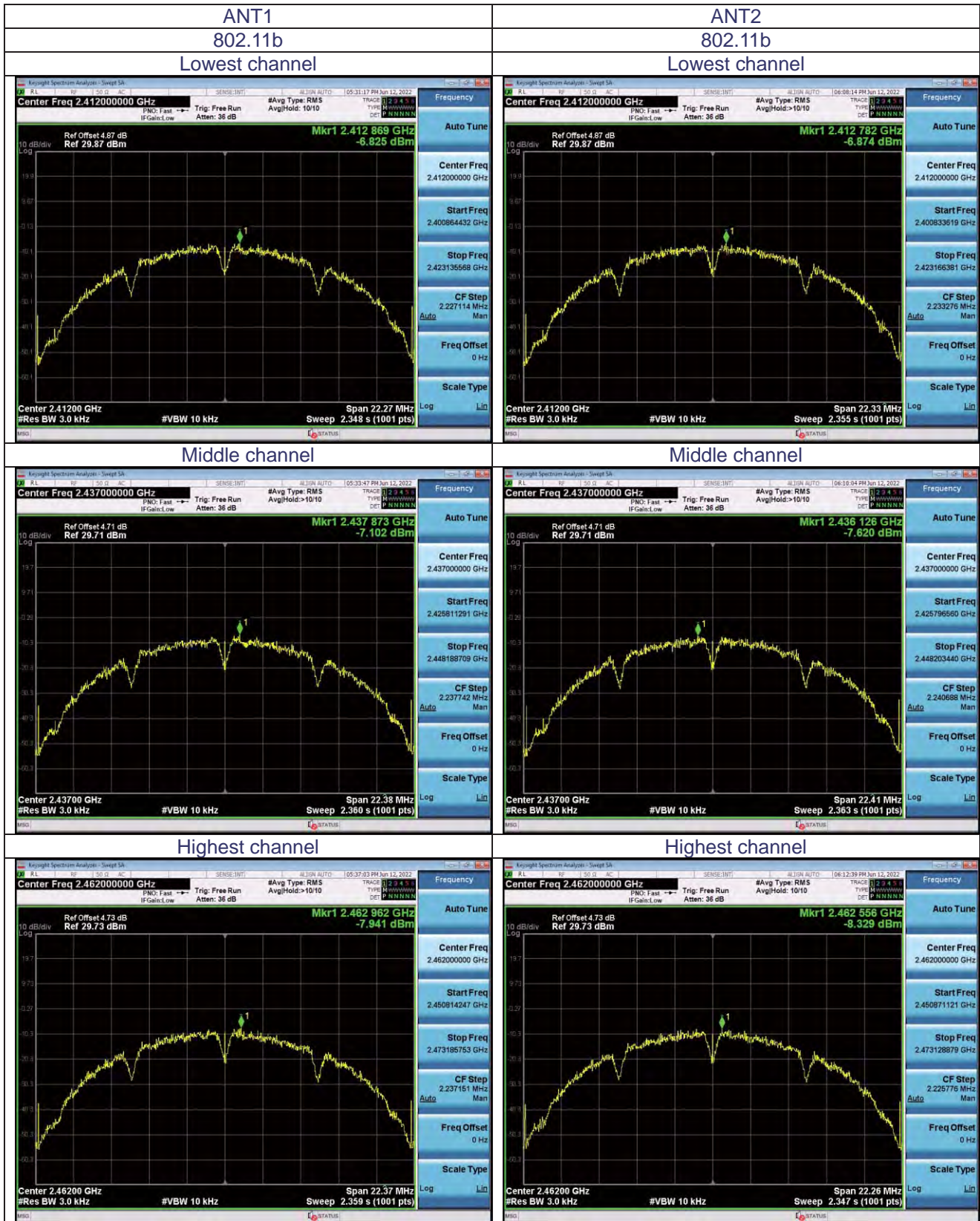

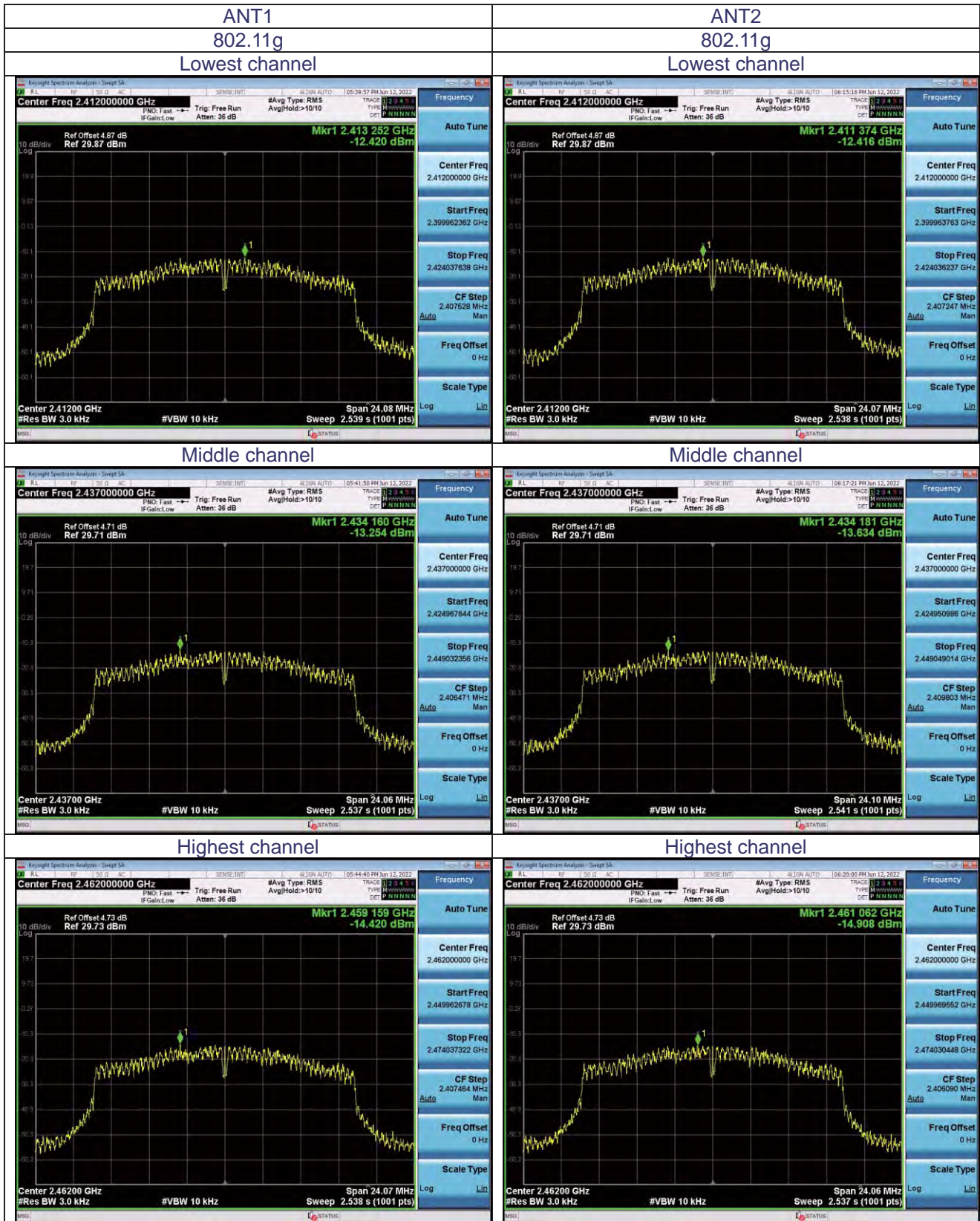

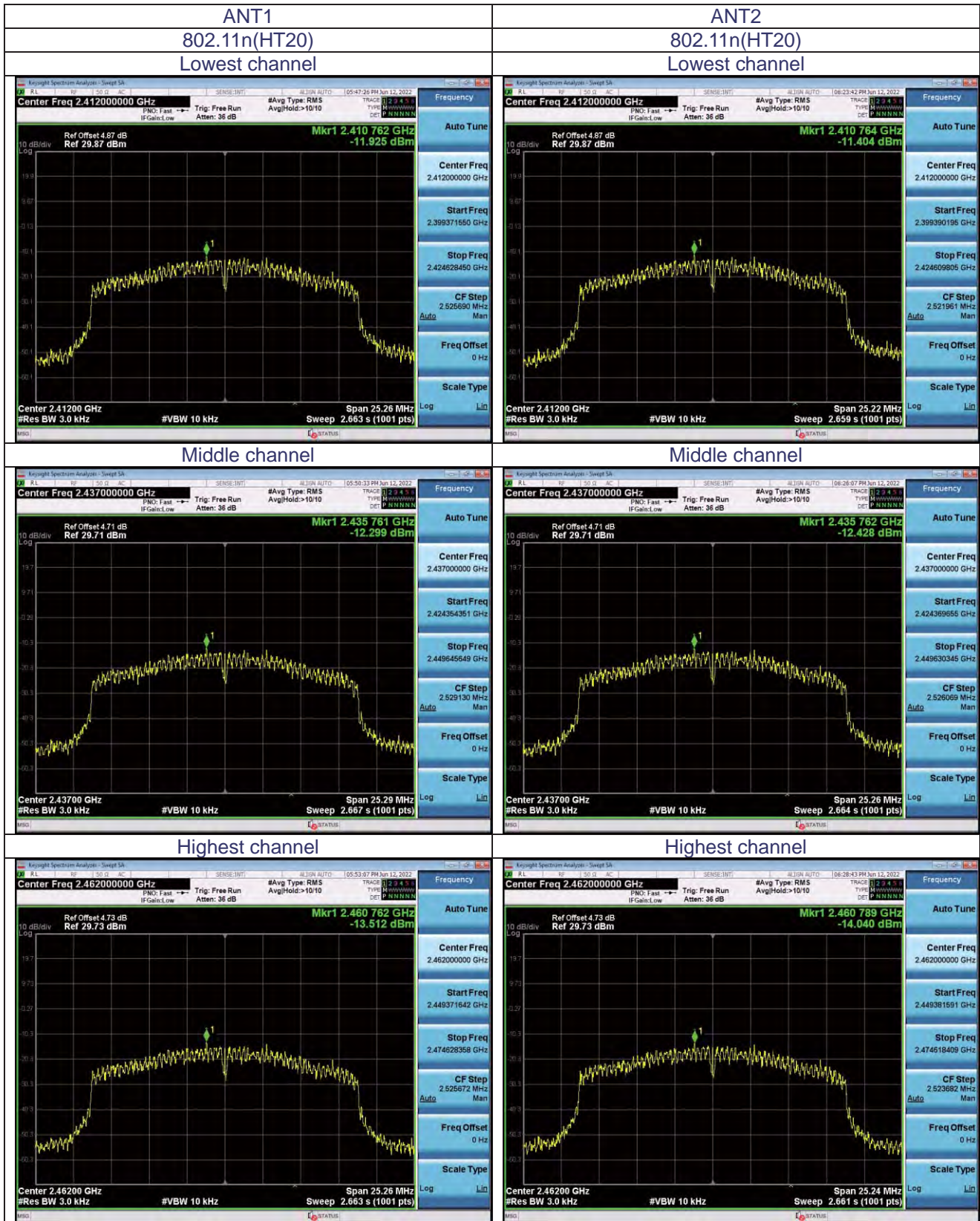

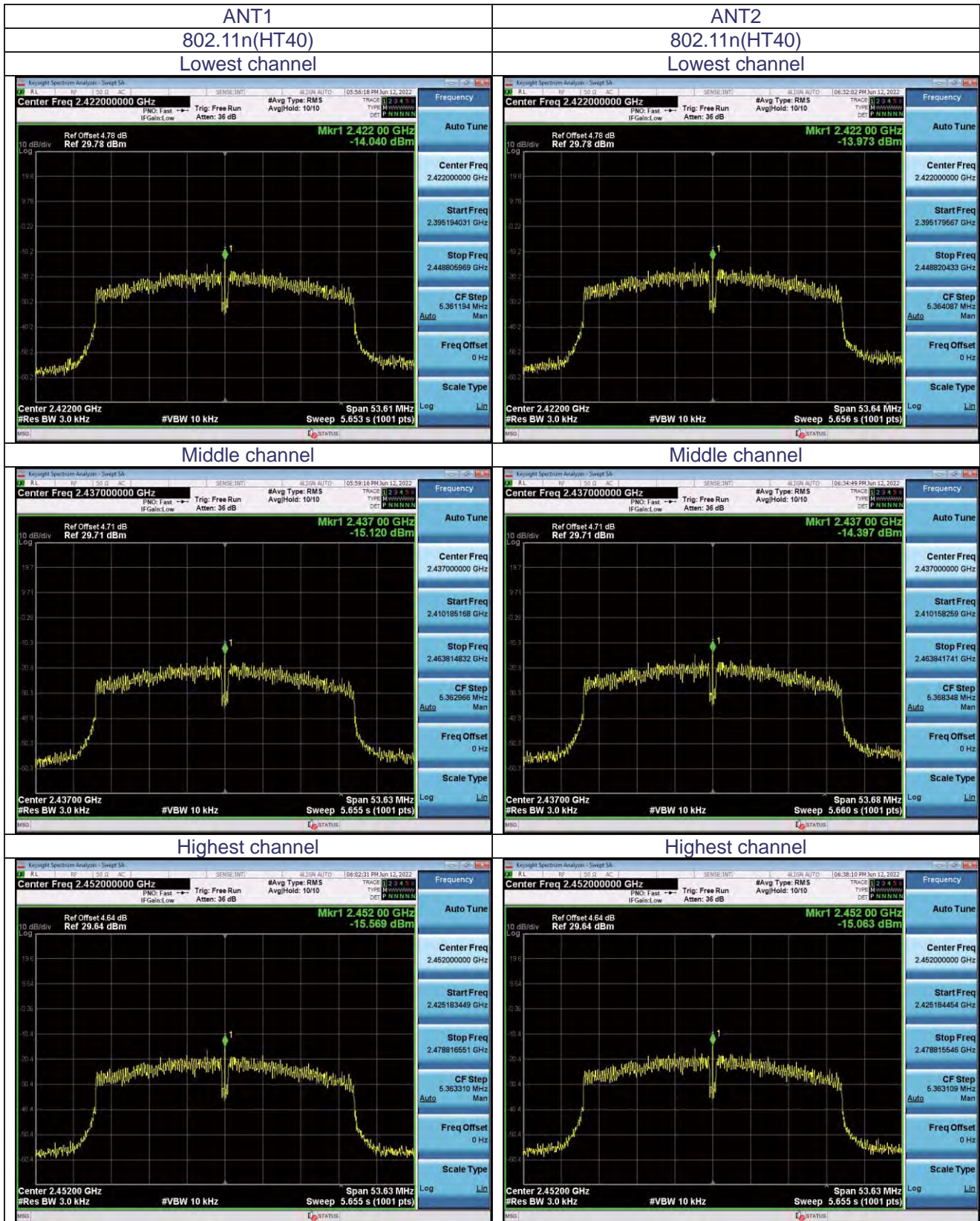

7. CHANNEL BANDWIDTH

Test Requirement:	FCC Part15 C Section 15.247 (a)(2)
Test Method:	KDB558074 D0115.247 Meas Guidance v05r02

7.1 APPLIED PROCEDURES / LIMIT

FCC Part15 (15.247) , Subpart C				
Section	Test Item	Limit	Frequency Range (MHz)	Result
15.247(a)(2)	Bandwidth	$\geq 500\text{KHz}$ (6dB bandwidth)	2400-2483.5	PASS

7.2 TEST PROCEDURE

1. Set RBW = 100 kHz.
2. Set the video bandwidth (VBW) $\geq 3 \times \text{RBW}$.
3. Detector = Peak.
4. Trace mode = max hold.
5. Sweep = auto couple.
6. Allow the trace to stabilize.
7. Measure the maximum width of the emission that is constrained by the frequencies associated with the two outermost amplitude points (upper and lower frequencies) that are attenuated by 6 dB relative to the maximum level measured in the fundamental emission.

7.3 DEVIATION FROM STANDARD

No deviation.

7.4 TEST SETUP



7.5 EUT OPERATION CONDITIONS

The EUT tested system was configured as the statements of 2.4 Unless otherwise a special operating condition is specified in the follows during the testing.

7.6 TEST RESULT

Temperature :	26°C	Relative Humidity :	54%
Pressure :	101kPa	Test Voltage :	DC5.0V
Test Mode :	TX Mode		

Test mode	Test channel	6dB Emission Bandwidth (MHz)		Limit:	Test Result:
		ANT1	ANT2		
802.11b	Lowest	9.017	7.455	>500kHz	PASS
	Middle	9.102	9.530		
	Highest	9.015	8.594		
802.11g	Lowest	12.59	9.205	>500kHz	PASS
	Middle	9.462	11.61		
	Highest	10.66	12.62		
802.11n(HT20)	Lowest	9.492	8.851	>500kHz	PASS
	Middle	7.901	9.714		
	Highest	8.097	9.172		
802.11n(HT40)	Lowest	24.70	17.63	>500kHz	PASS
	Middle	33.81	30.14		
	Highest	30.11	28.79		

Test plot as follows:

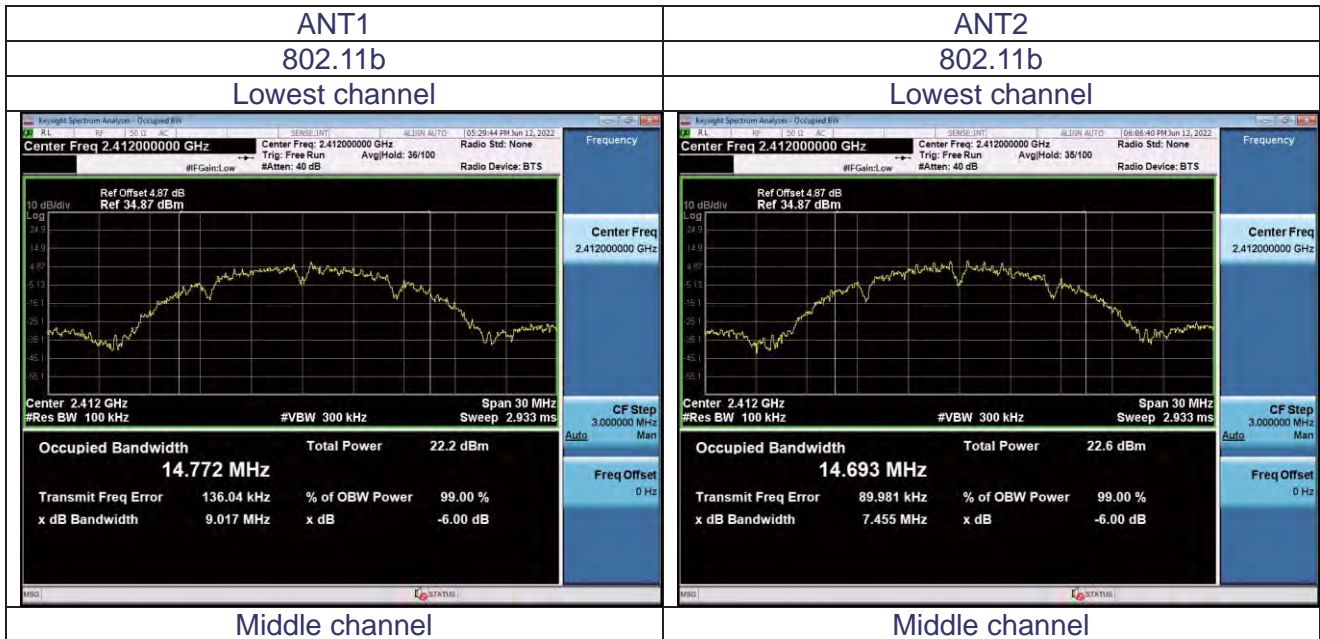



Highest channel

Highest channel

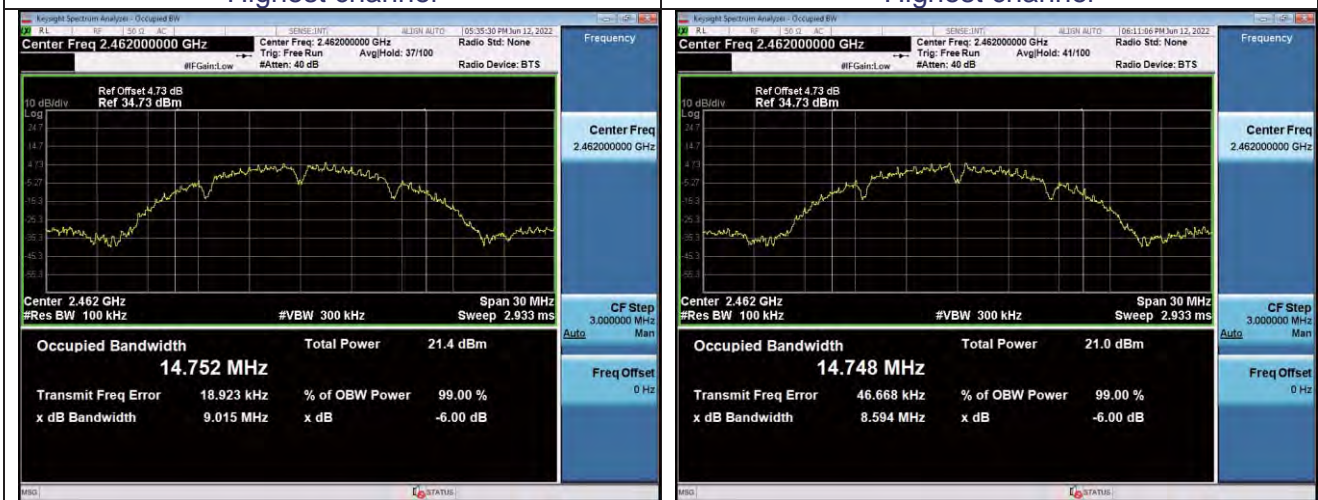

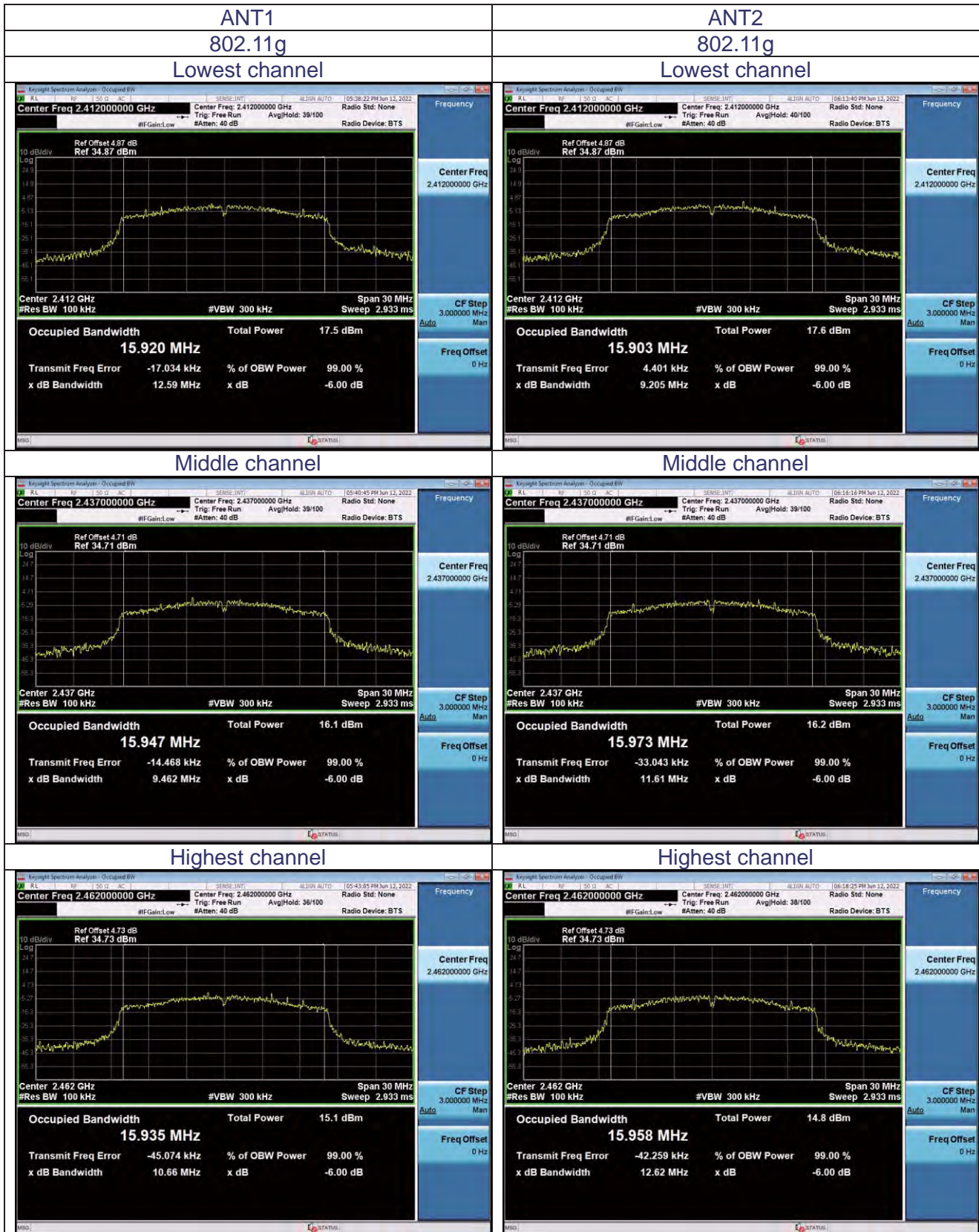

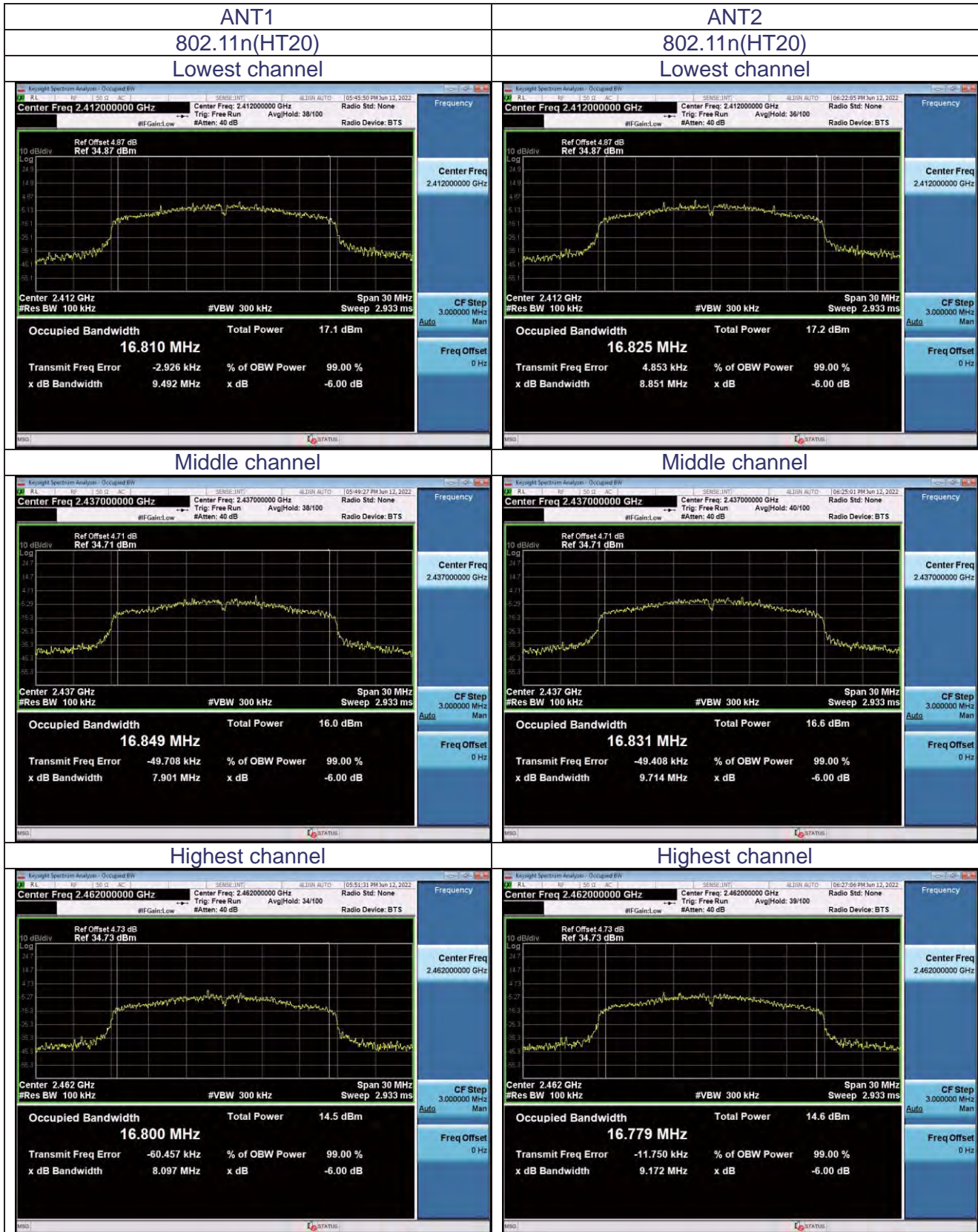

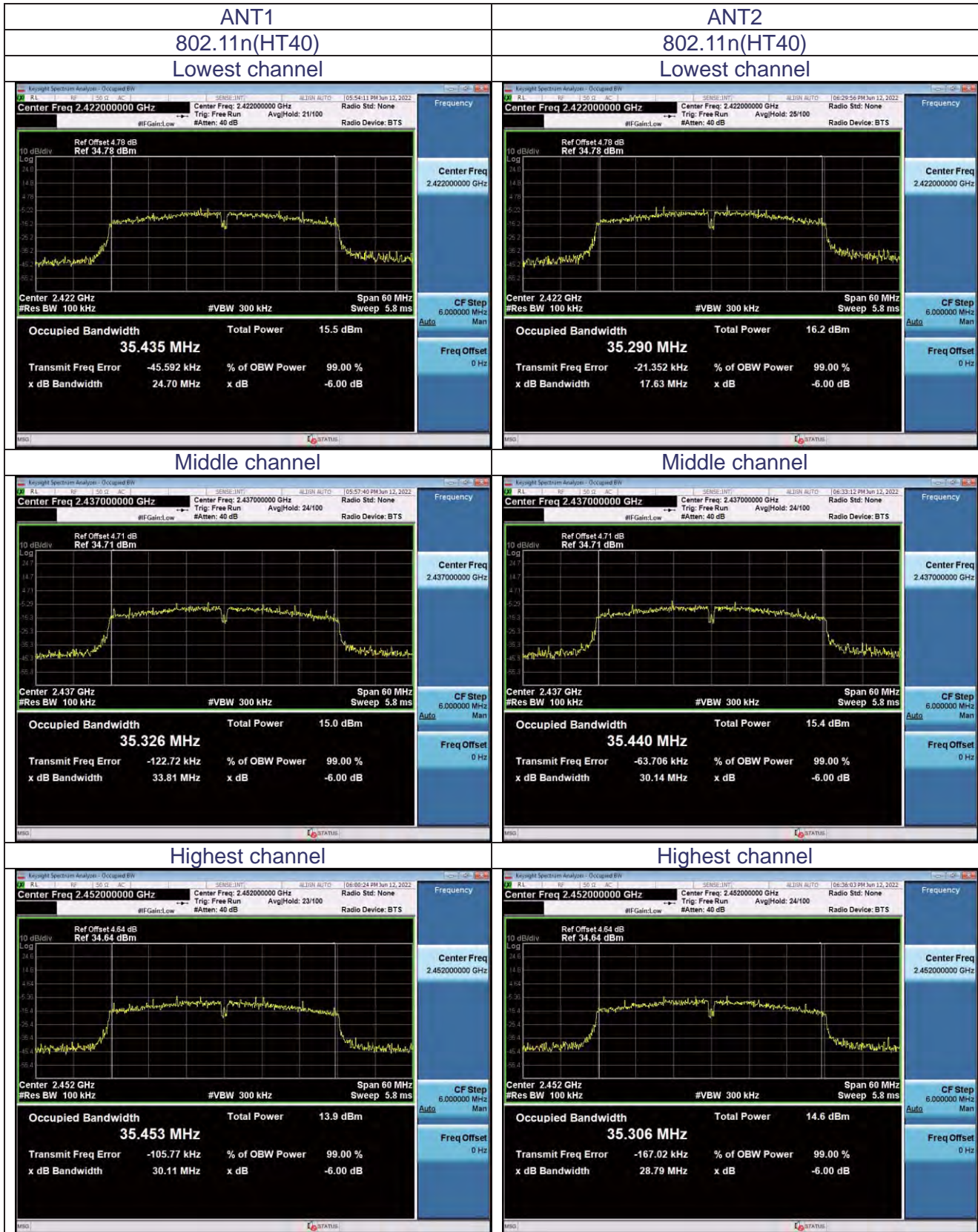

8. OUTPUT POWER TEST

Test Requirement:	FCC Part15 C Section 15.247 (b)(3)
Test Method:	KDB558074 D0115.247 Meas Guidance v05r02

8.1 APPLIED PROCEDURES/LIMIT

FCC Part15 (15.247) , Subpart C				
Section	Test Item	Limit	Frequency Range (MHz)	Result
15.247(b)(3)	Peak Output Power	1 watt or 30dBm	2400-2483.5	PASS

8.2 TEST PROCEDURE

- a. The EUT was directly connected to the Power meter

8.3 DEVIATION FROM STANDARD

No deviation.

8.4 TEST SETUP



8.5 EUT OPERATION CONDITIONS

The EUT tested system was configured as the statements of 2.4 Unless otherwise a special operating condition is specified in the follows during the testing.

8.6 TEST RESULT

Temperature :	26°C	Relative Humidity :	54%
Pressure :	101kPa	Test Voltage :	DC5.0V

Modulation	Test Channel	Frequency (MHz)	Maximum Peak Conducted Output Power (dBm)			LIMIT
			Antenna 1	Antenna 2	MIMO	dBm
802.11b	CH01	2412	17.88	18.12	/	30
802.11b	CH06	2437	17.33	17.42	/	30
802.11b	CH11	2462	16.46	16.32	/	30
802.11g	CH01	2412	17.30	17.34	/	30
802.11g	CH06	2437	16.48	16.46	/	30
802.11g	CH11	2462	15.09	15.15	/	30
802.11n(HT20)	CH01	2412	16.98	16.98	19.99	30
802.11n(HT20)	CH06	2437	16.18	16.19	19.20	30
802.11n(HT20)	CH11	2462	14.80	14.88	17.85	30
802.11n(HT40)	CH03	2422	15.40	15.20	18.31	30
802.11n(HT40)	CH06	2437	14.86	15.58	18.25	30
802.11n(HT40)	CH09	2452	14.05	14.69	17.39	30

Note: This product supports antenna 1 and antenna 2 launch, but only support 802.11 n for MIMO mode, not support 802.11 b and 802.11 g for MIMO mode.

9. CONDUCTED BAND EDGE AND SPURIOUS EMISSION

Test Requirement:	FCC Part15 C Section 15.247 (d)
Test Method:	KDB558074 D0115.247 Meas Guidance v05r02

9.1 APPLICABLE STANDARD

in any 100 kHz bandwidth outside the frequency bands in which the spread spectrum intentional radiator is operating, the radio frequency power that is produced by the intentional radiator shall be at least 20dB below that in the 100kHz bandwidth within the band that contains the highest level of the desired power, In addition, radiated emissions which fall in the restricted bands, as defined in§15.205(a), must also comply with the radiated emission limits specified in15.209(a).

9.2 TEST PROCEDURE

Using the following spectrum analyzer setting:

- A) Set the RBW = 100KHz.
- B) Set the VBW = 300KHz.
- C) Sweep time = auto couple.
- D) Detector function = peak.
- E) Trace mode = max hold.
- F) Allow trace to fully stabilize.

9.3 DEVIATION FROM STANDARD

No deviation.

9.4 TEST SETUP



9.5 EUT OPERATION CONDITIONS

The EUT tested system was configured as the statements of 2.4 Unless otherwise a special operating condition is specified in the follows during the testing.

9.6 TEST RESULTS

Test plot as follows:

Middle Channel



High Channel

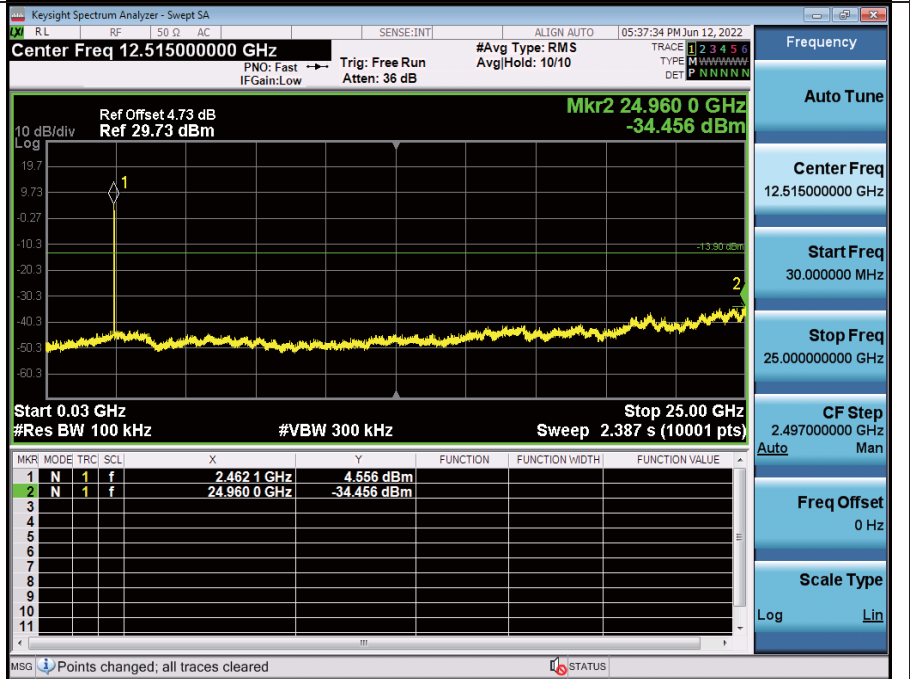
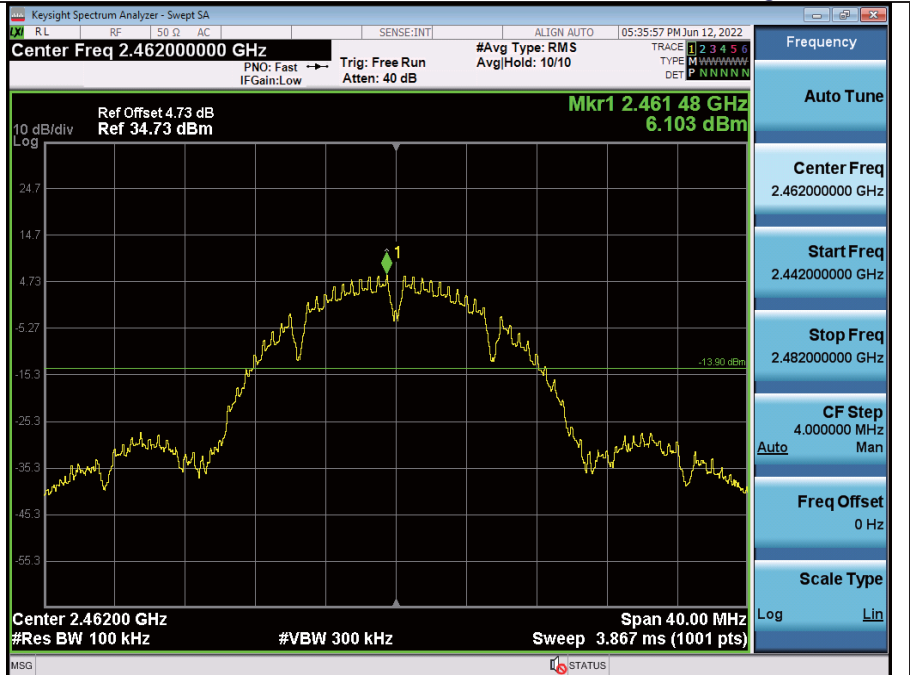

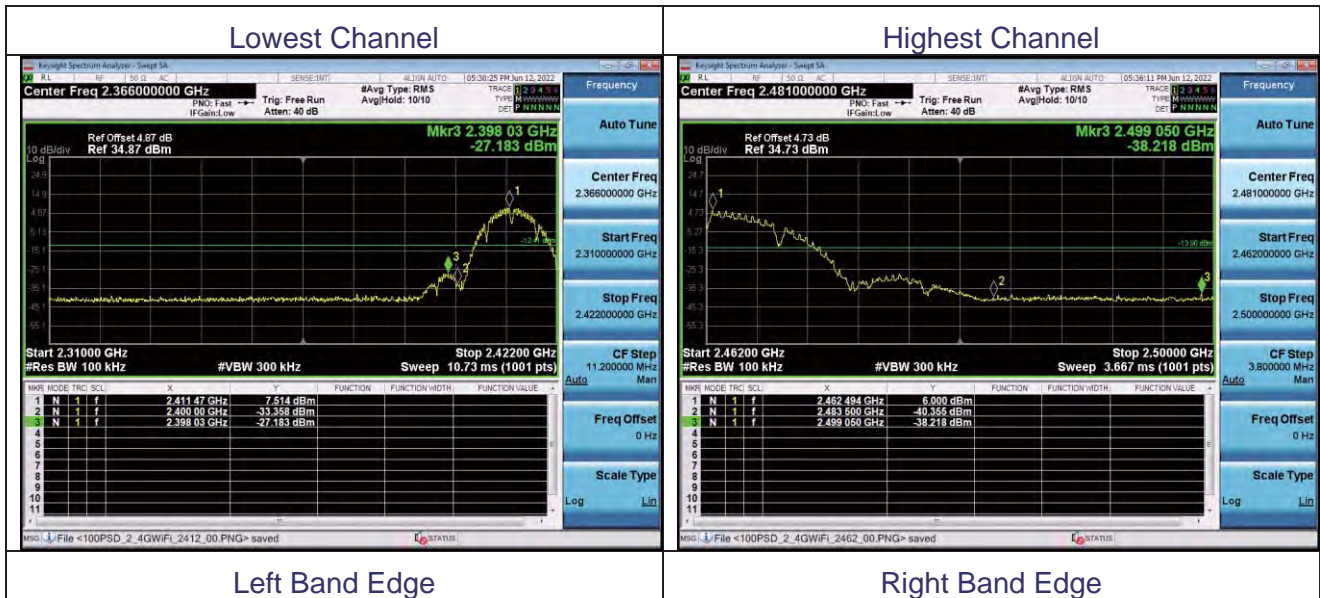

802.11g Modulation

Spurious emission

Low Channel

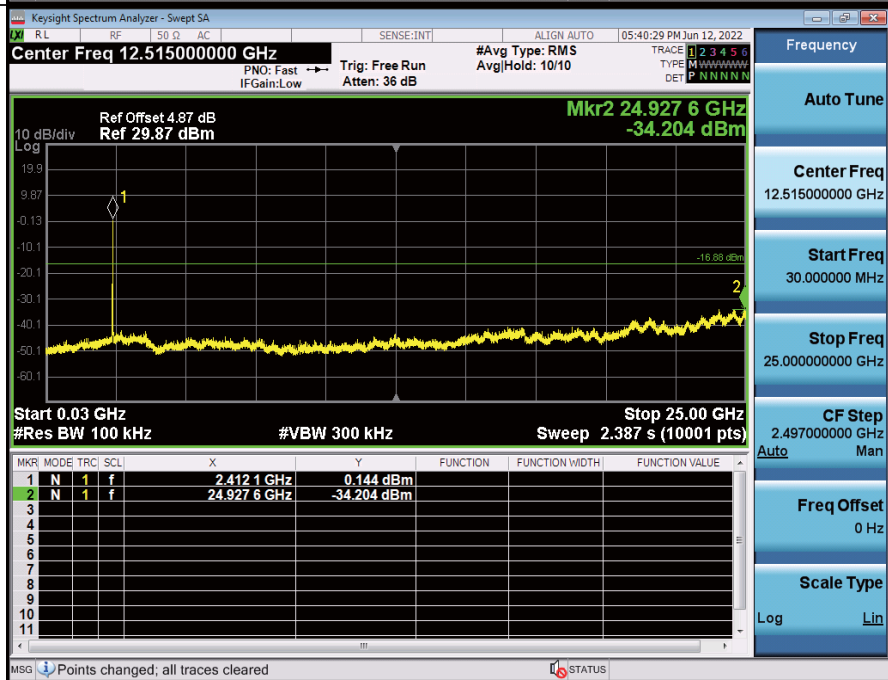
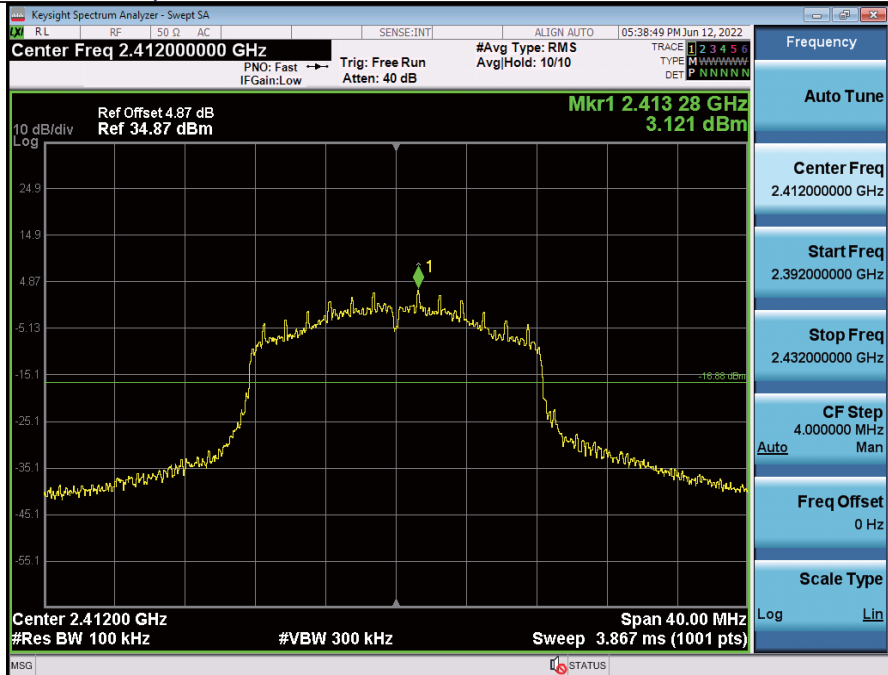

Middle Channel

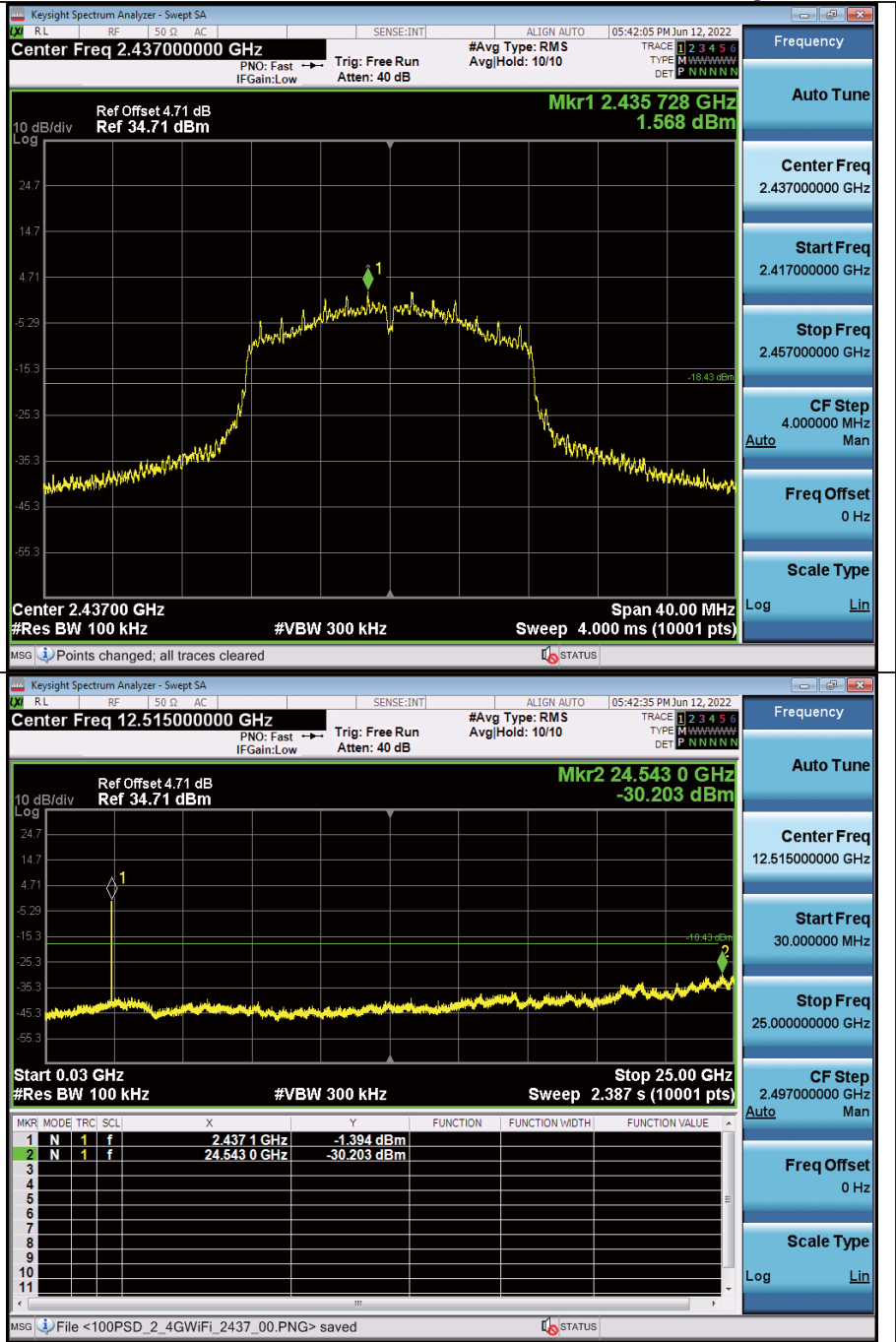

High Channel

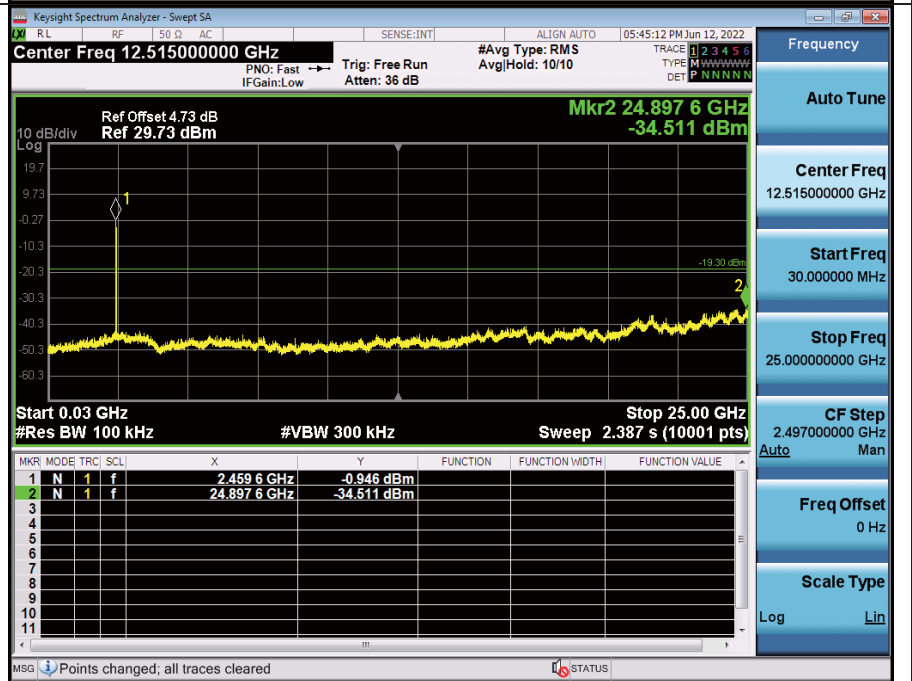
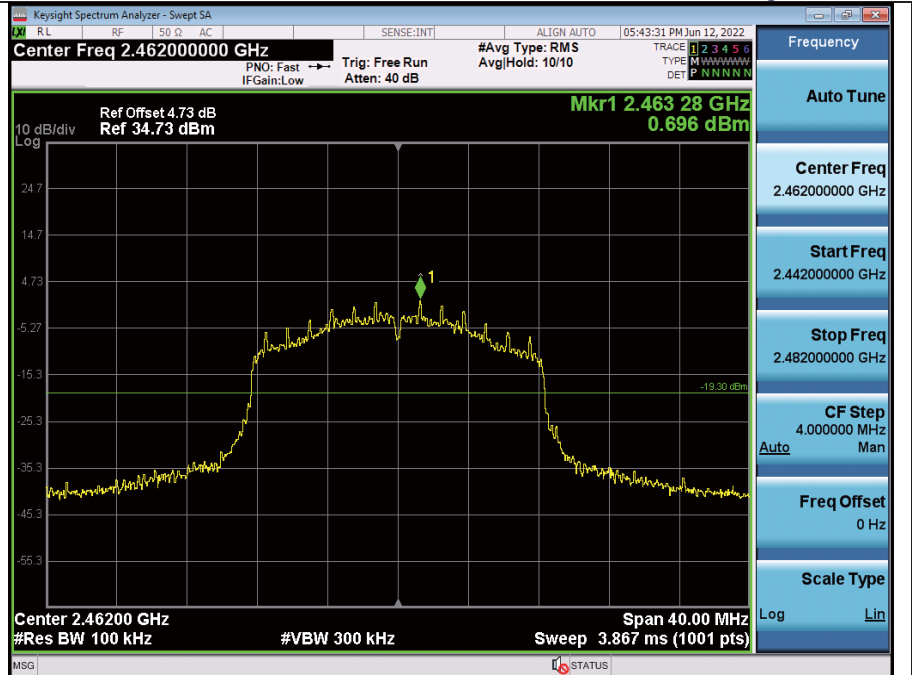

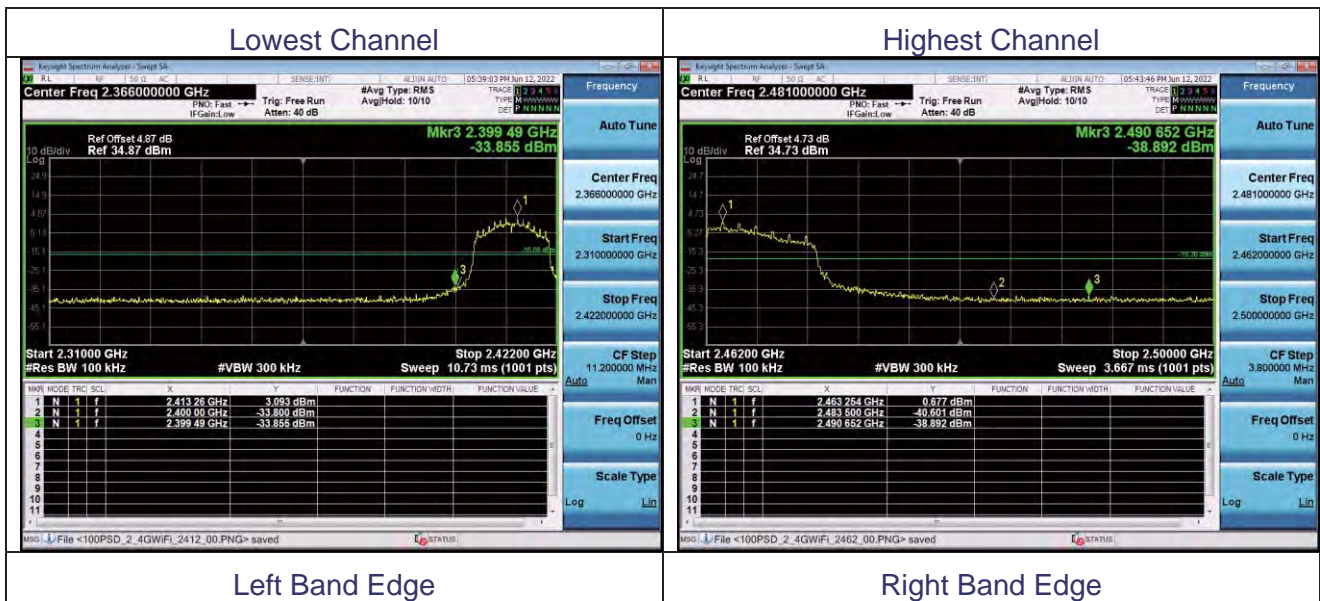

Middle Channel

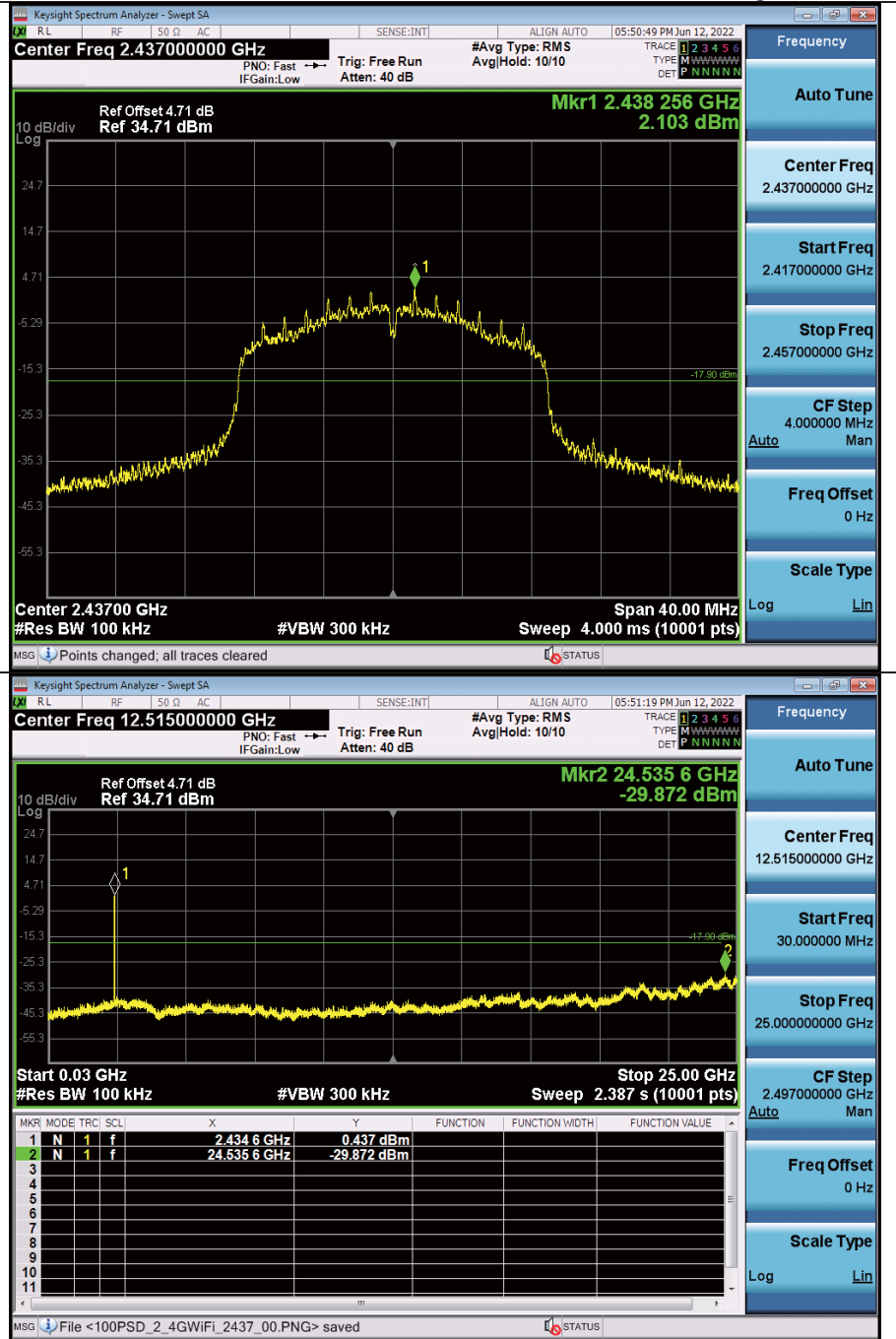

High Channel

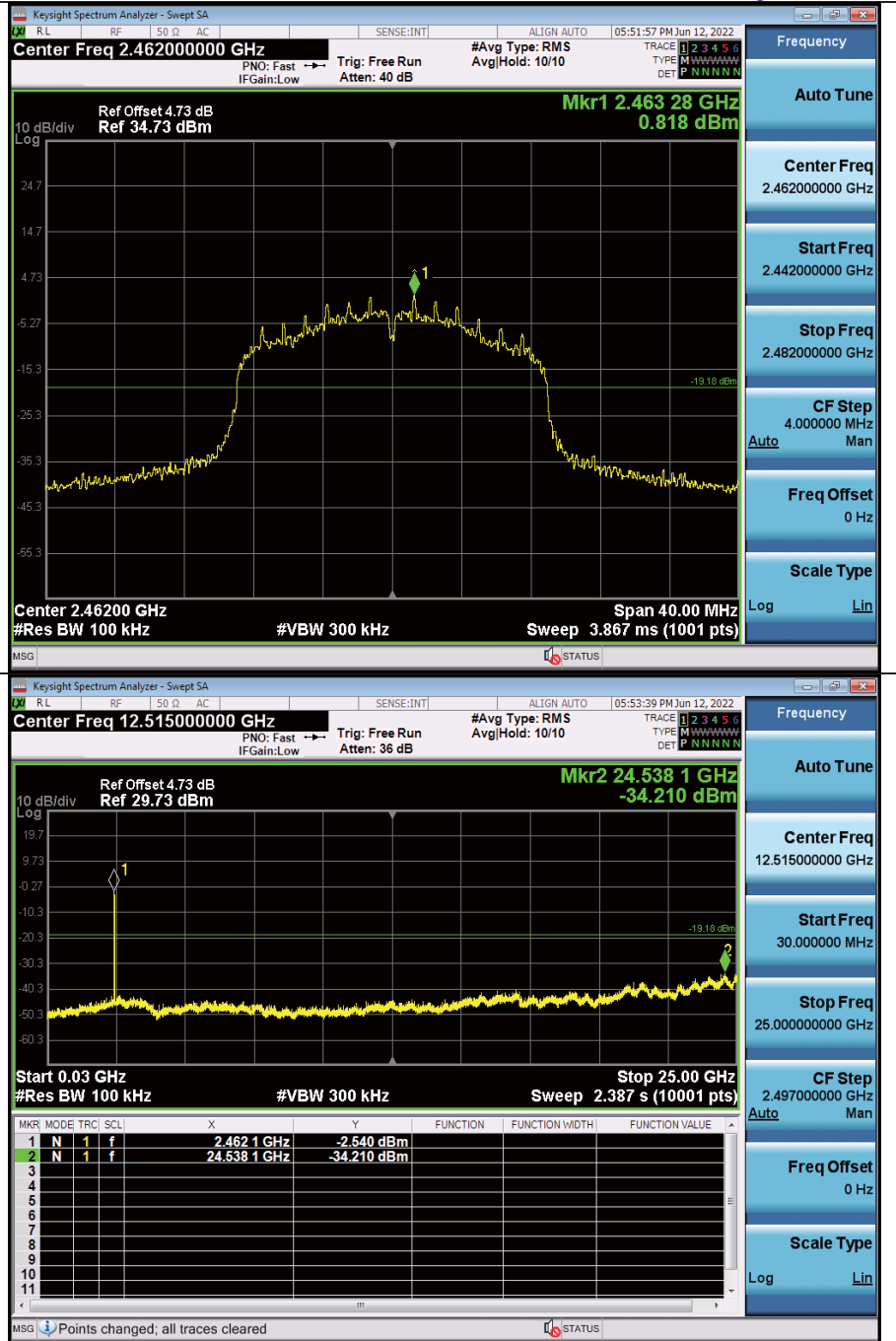

Lowest Channel

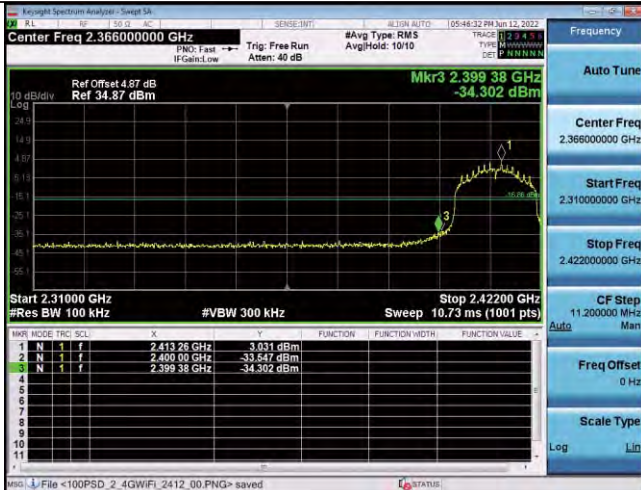

Left Band Edge

Highest Channel

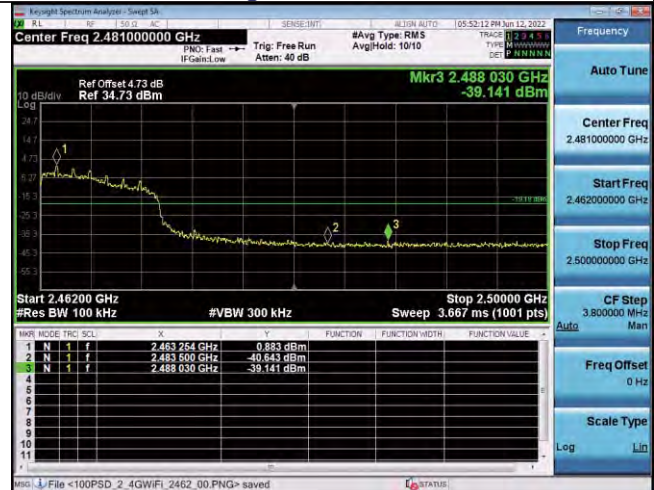

Right Band Edge

802.11n40 Modulation

Spurious emission

Low Channel

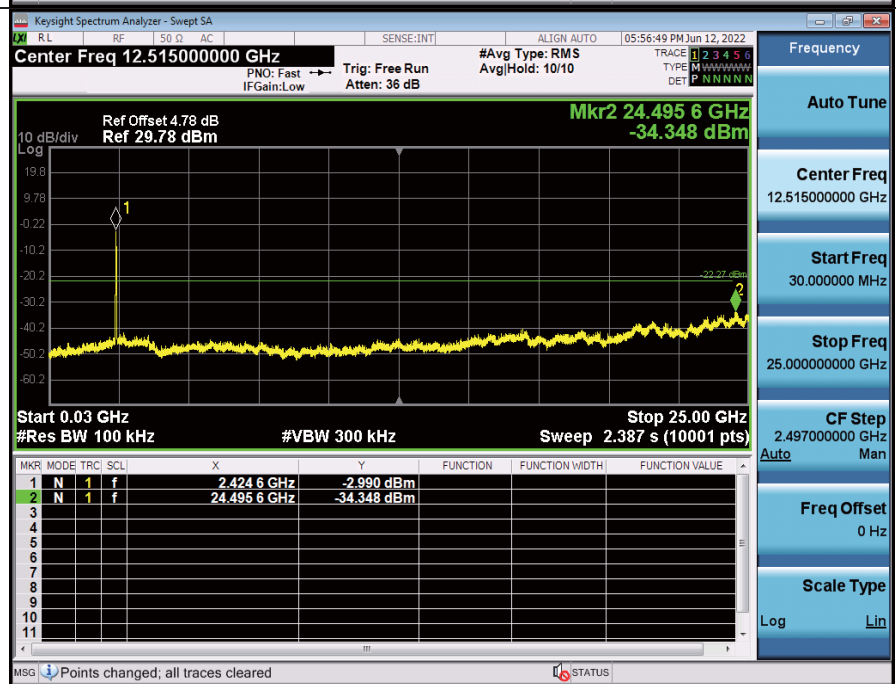
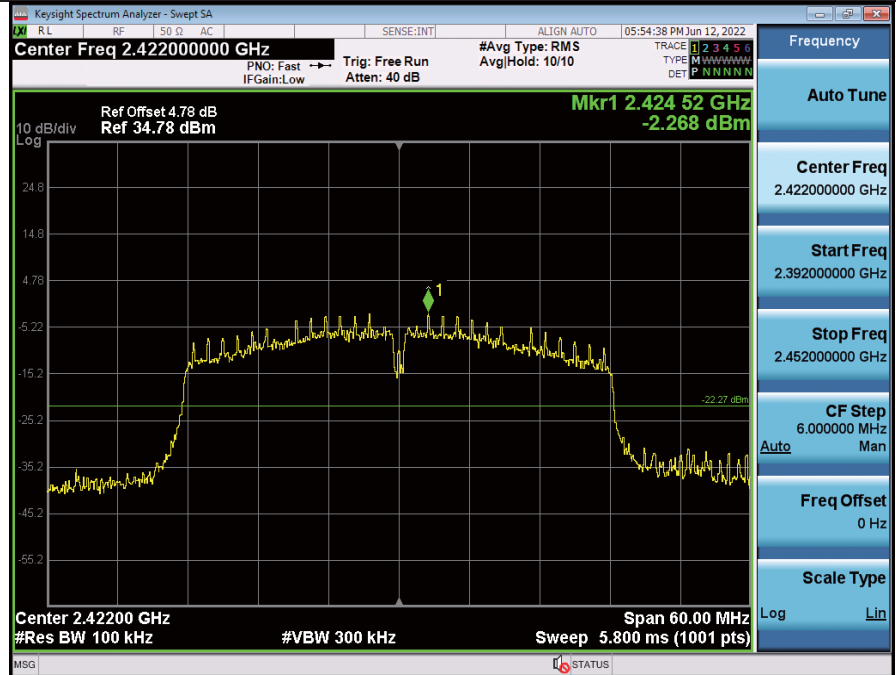

High Channel

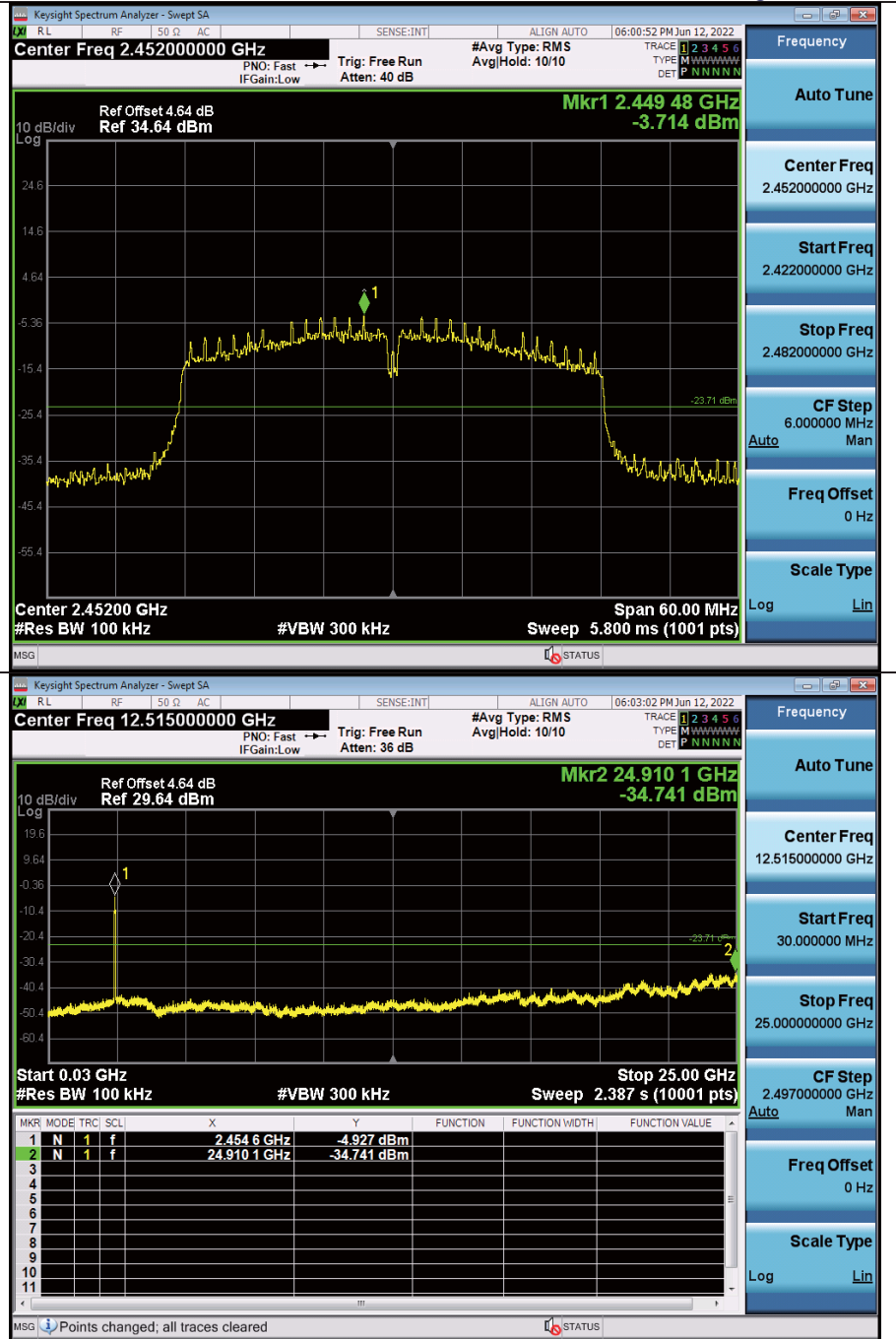

Lowest Channel



Left Band Edge

Highest Channel

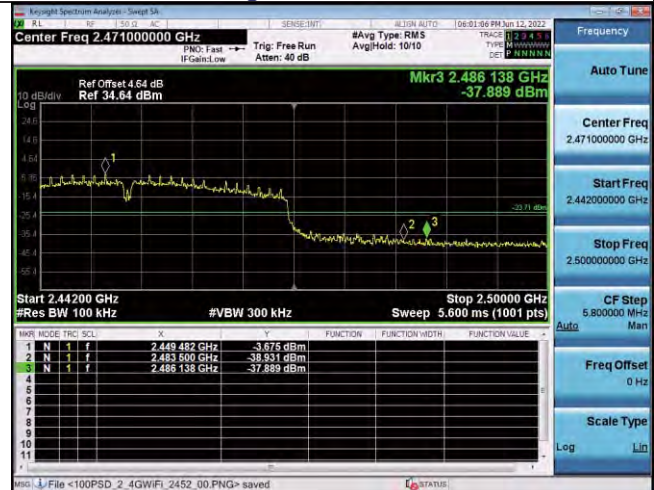

Right Band Edge

ANT2

802.11b Modulation

Spurious emission

Low Channel



High Channel

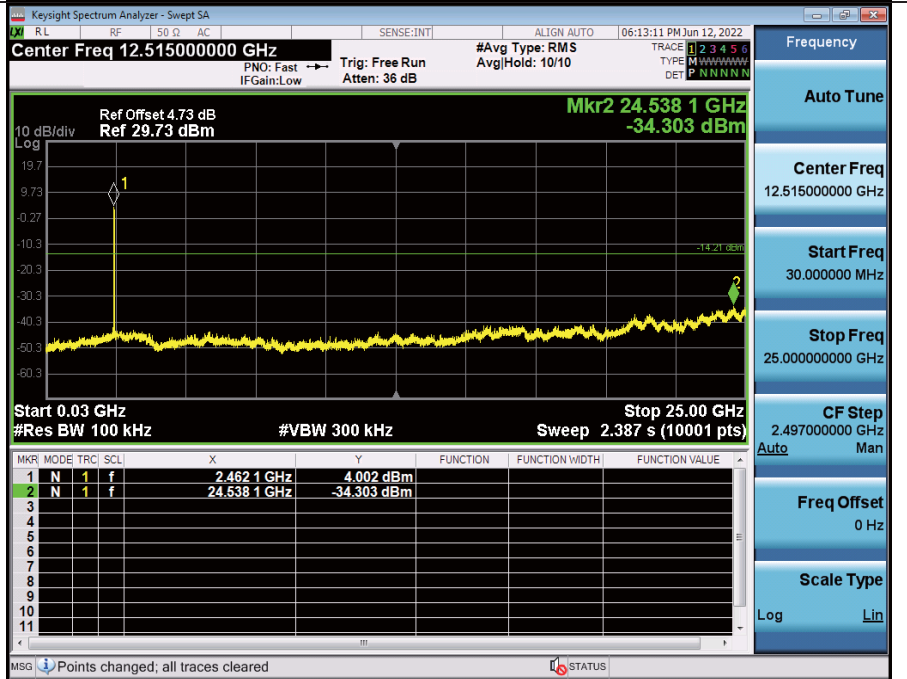
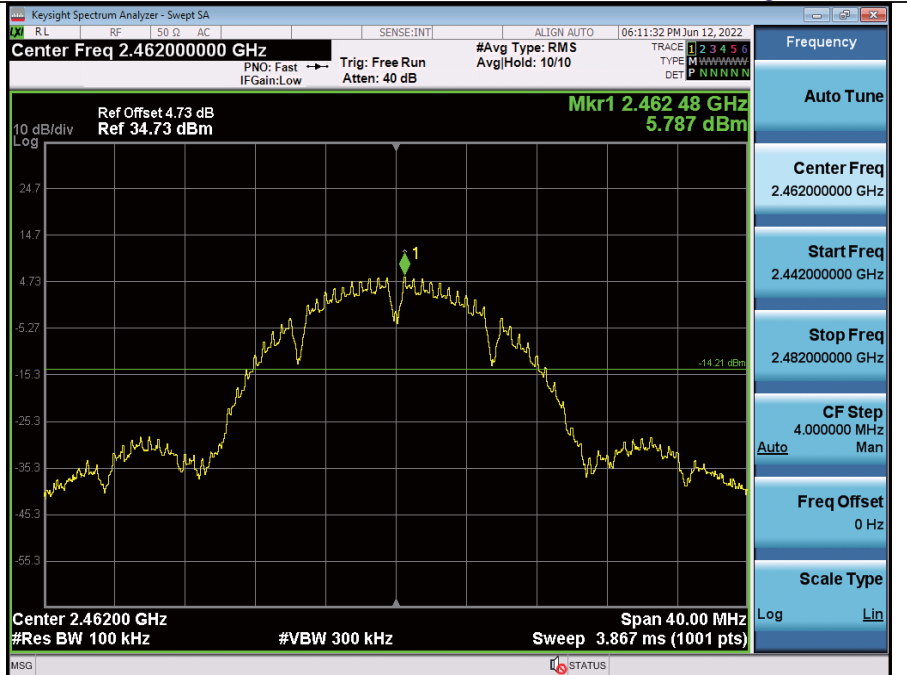

Lowest Channel

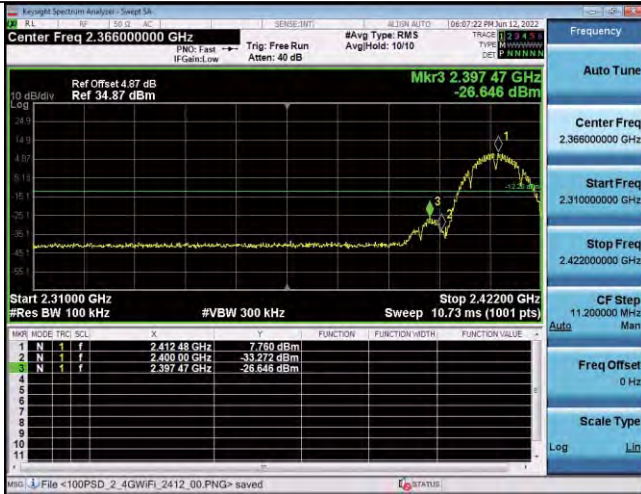

Left Band Edge

Highest Channel



Right Band Edge

802.11g Modulation

Spurious emission

Low Channel

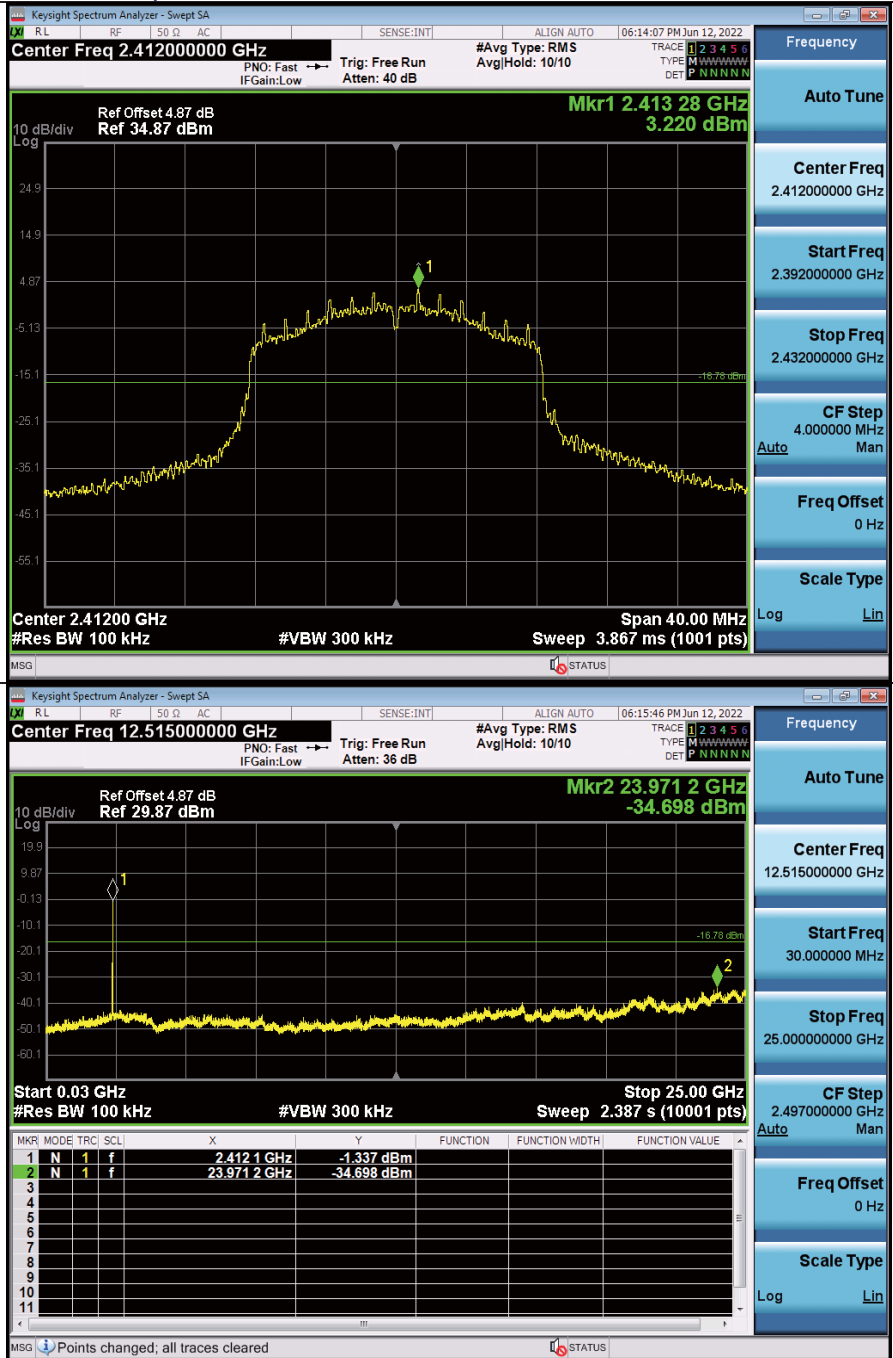

Middle Channel

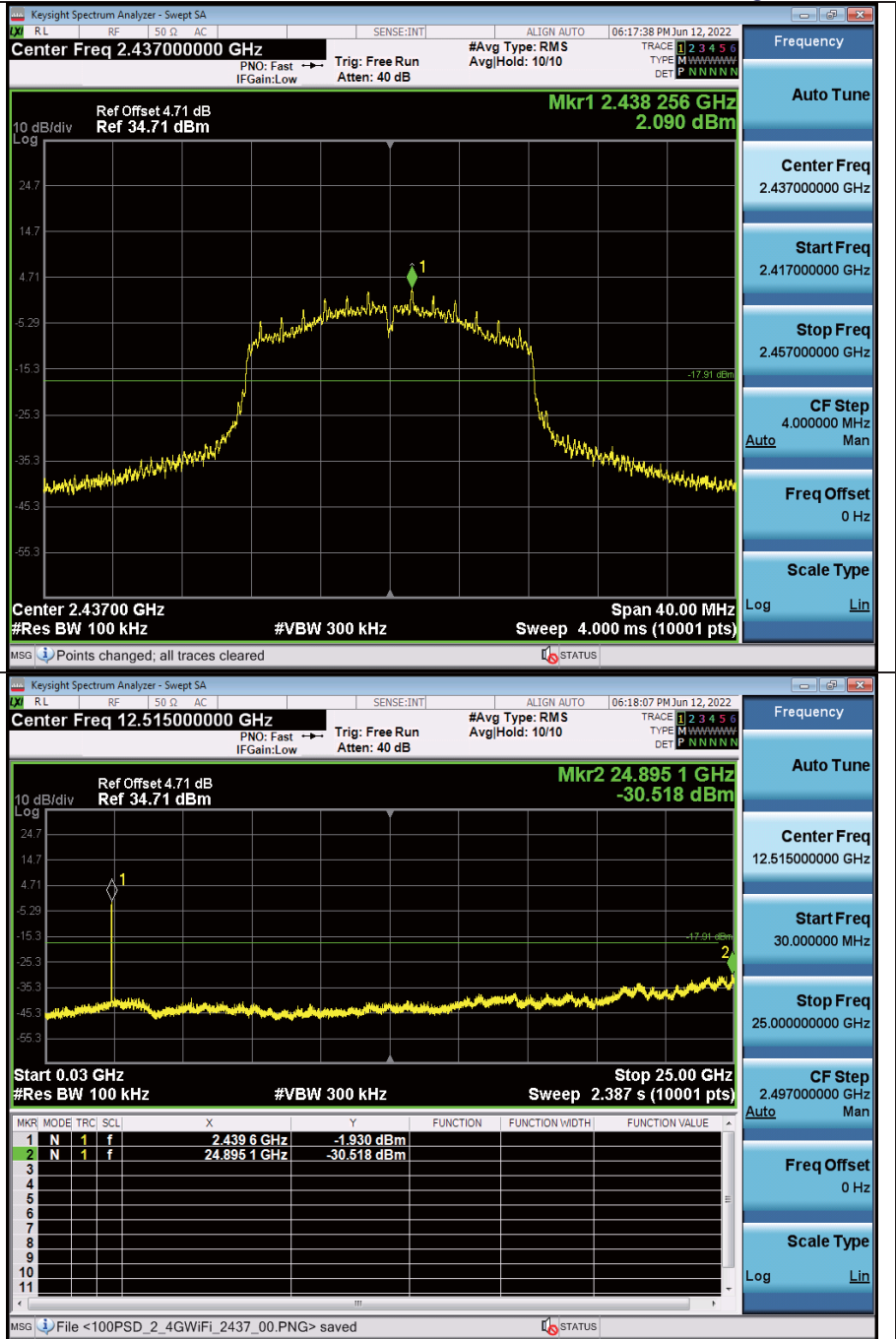

High Channel

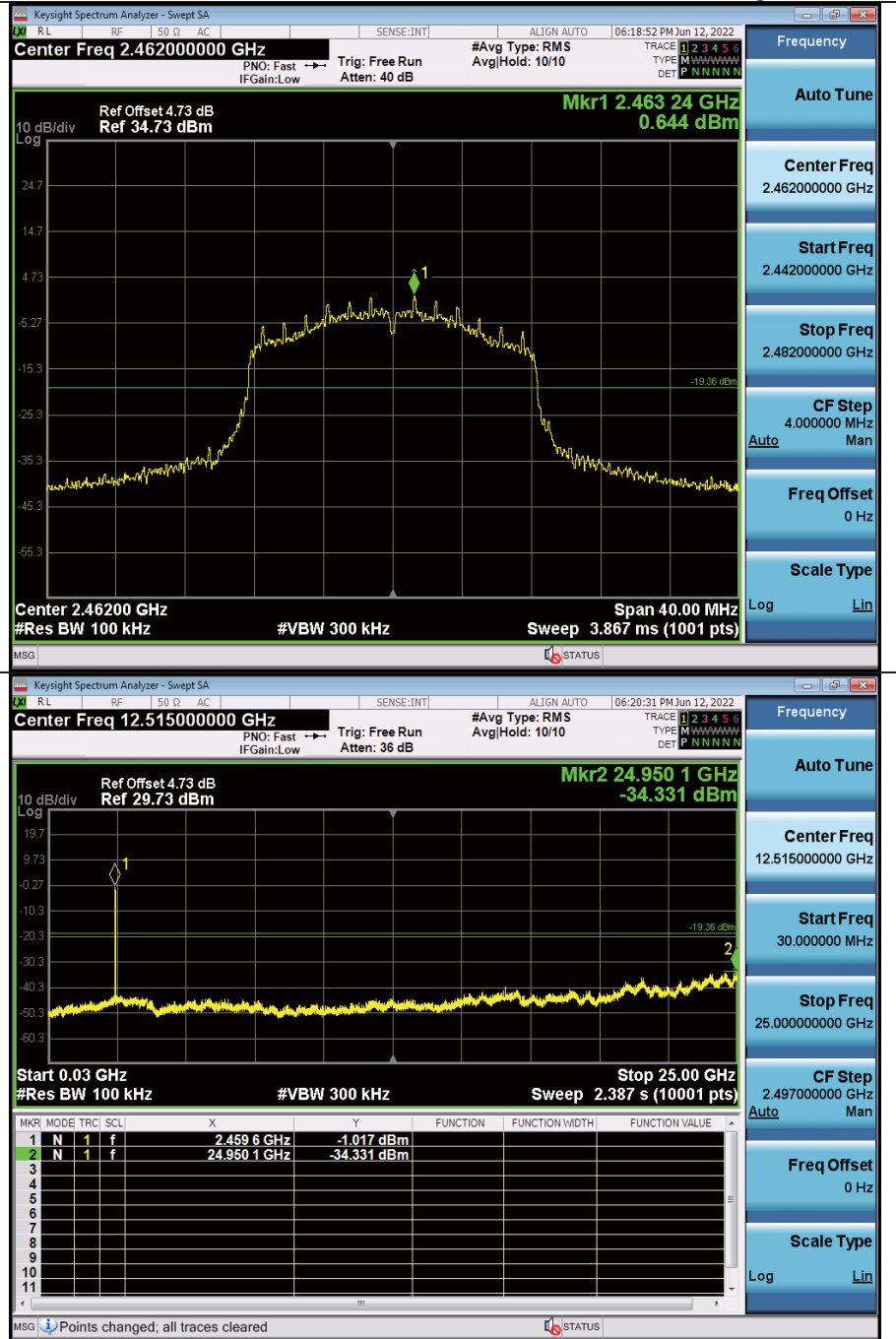

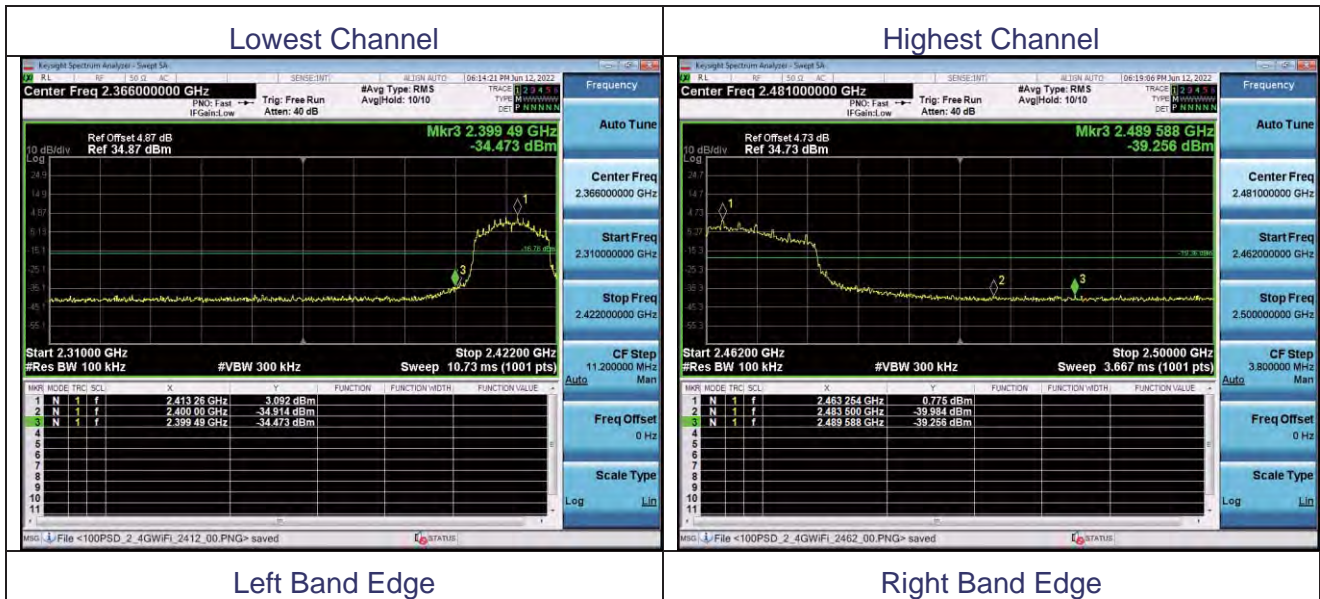

Middle Channel

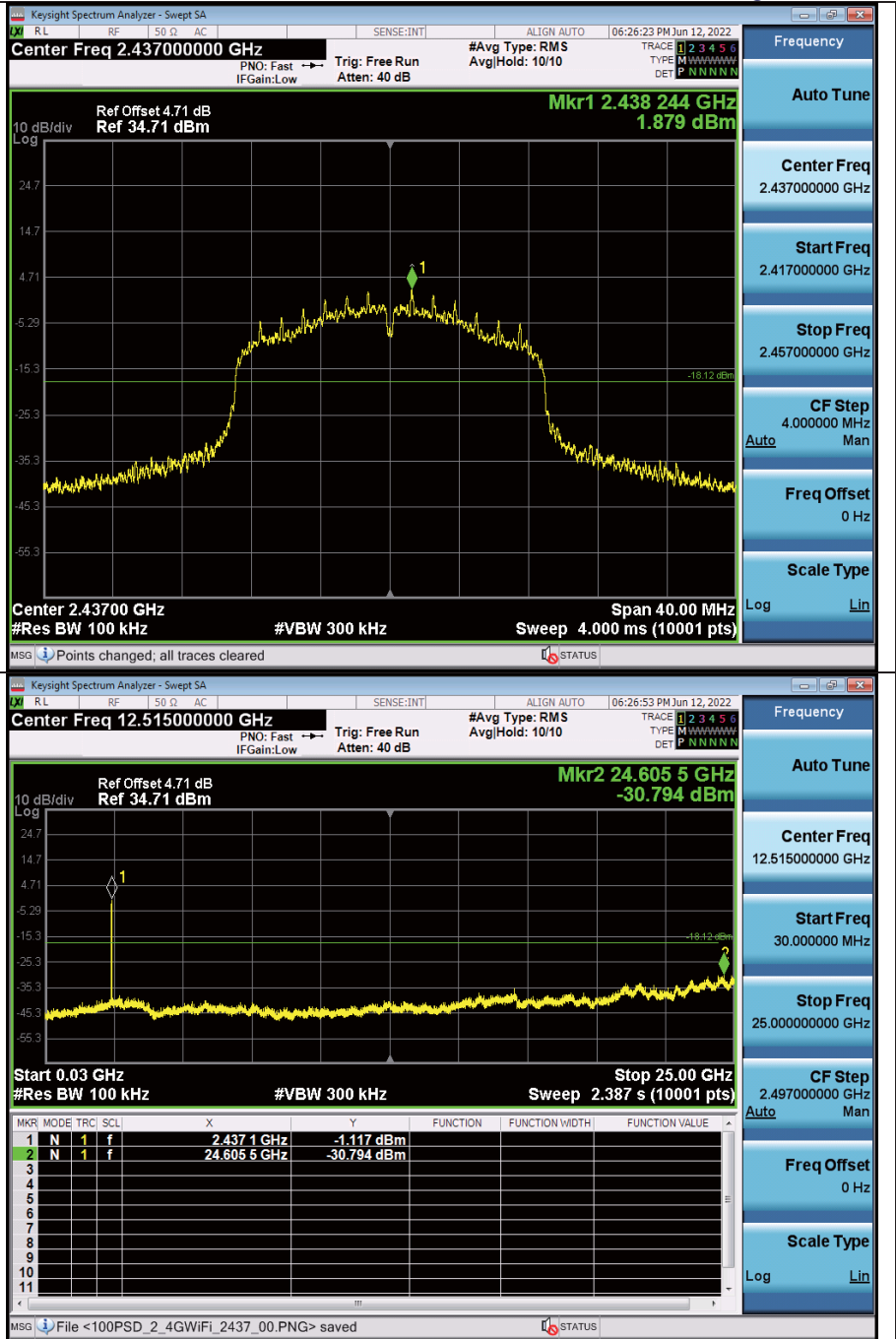

High Channel

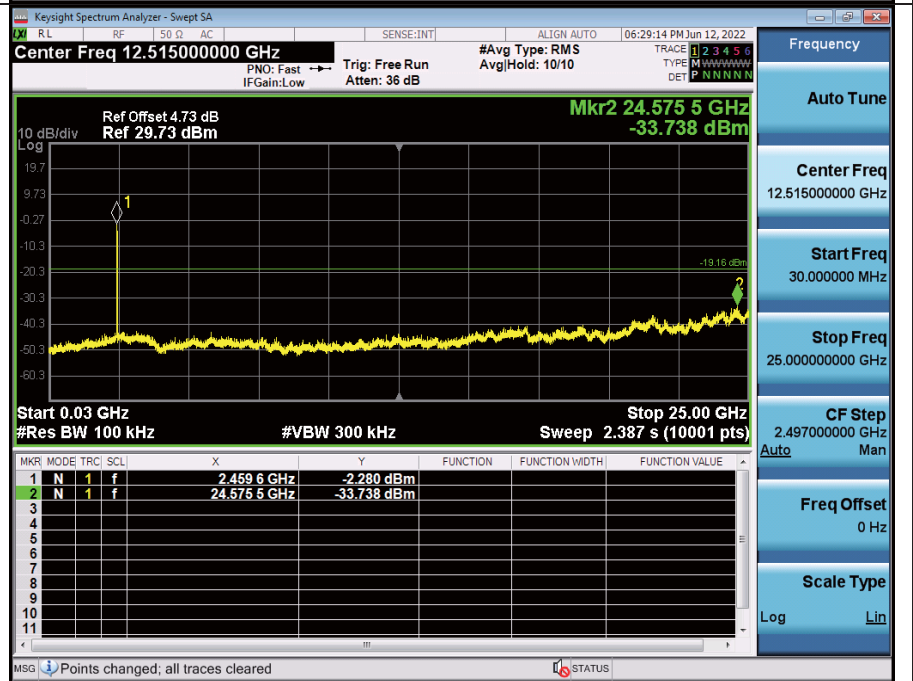
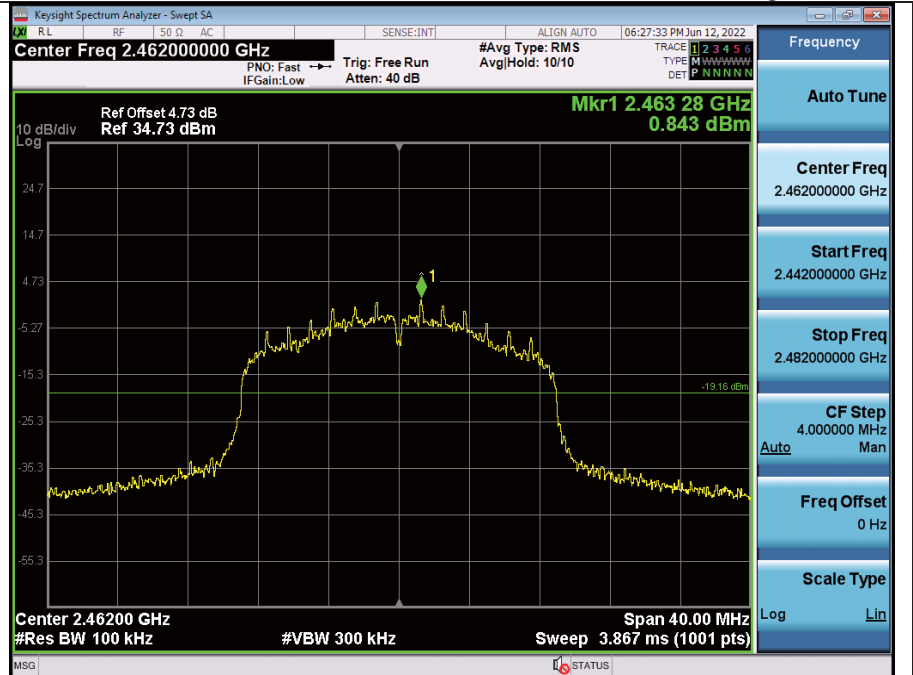

Lowest Channel

Highest Channel

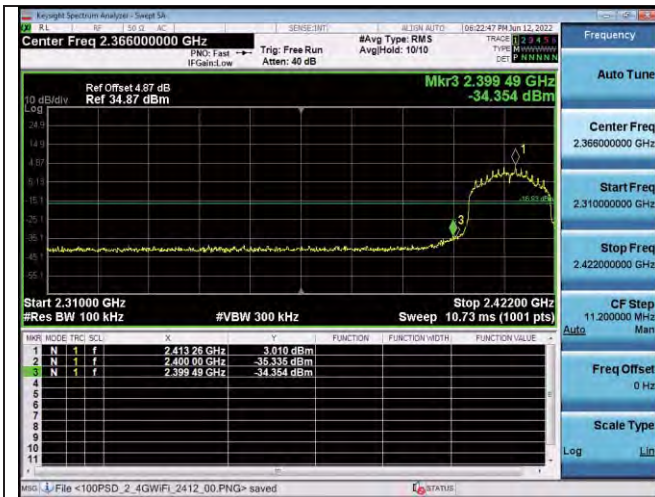

Left Band Edge

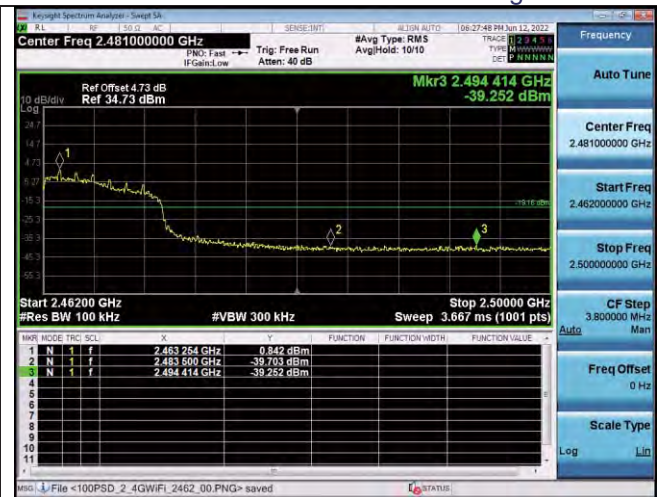

Right Band Edge

802.11n40 Modulation

Spurious emission

Low Channel

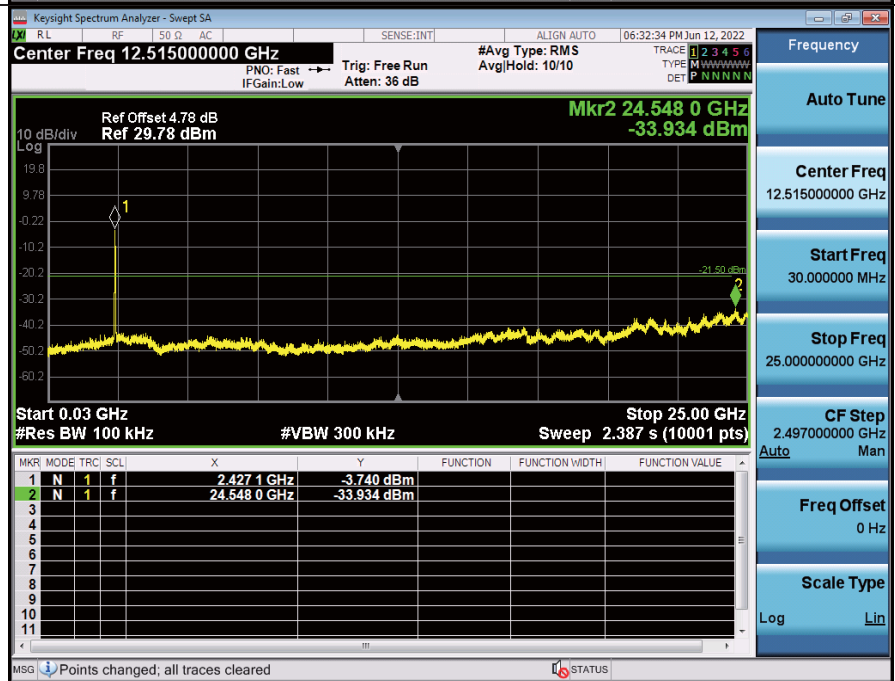
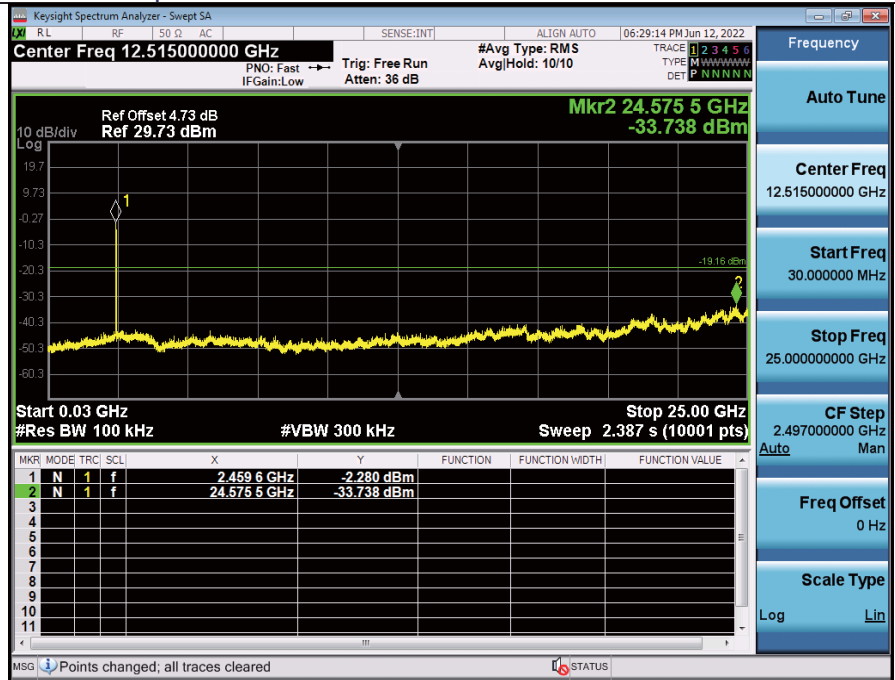

Middle Channel

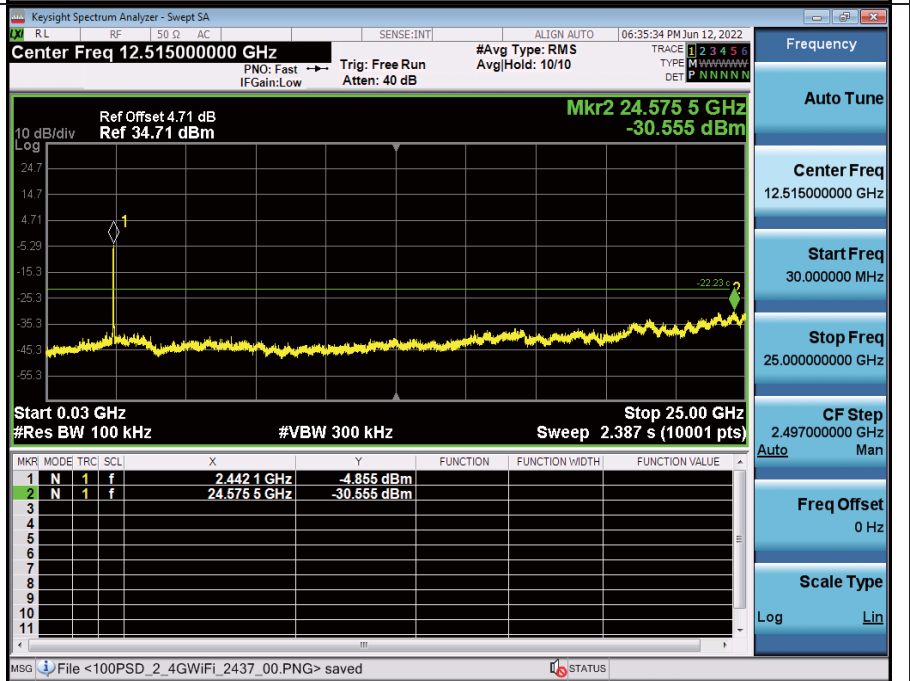
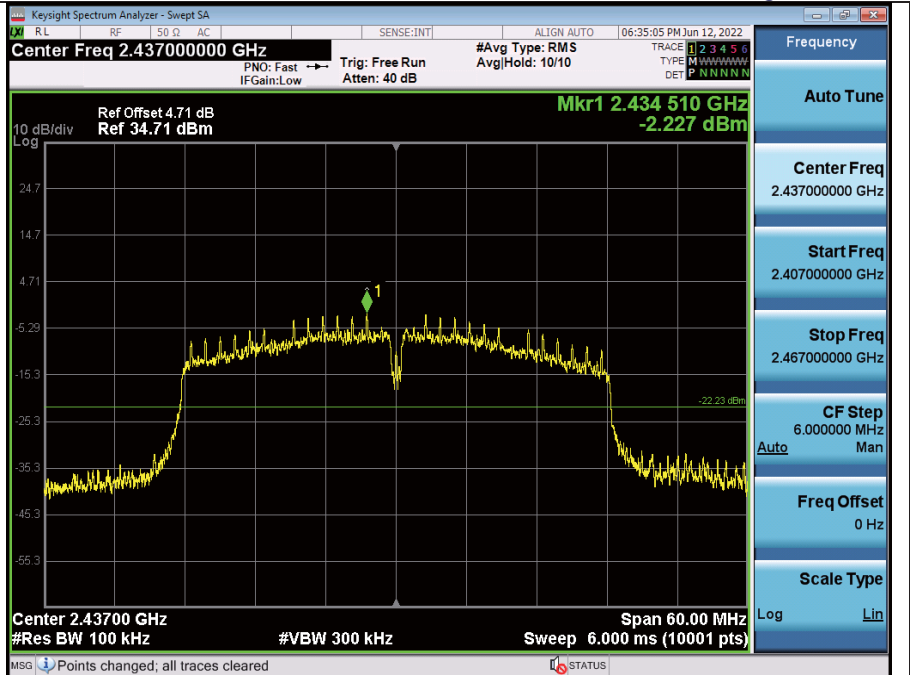

High Channel

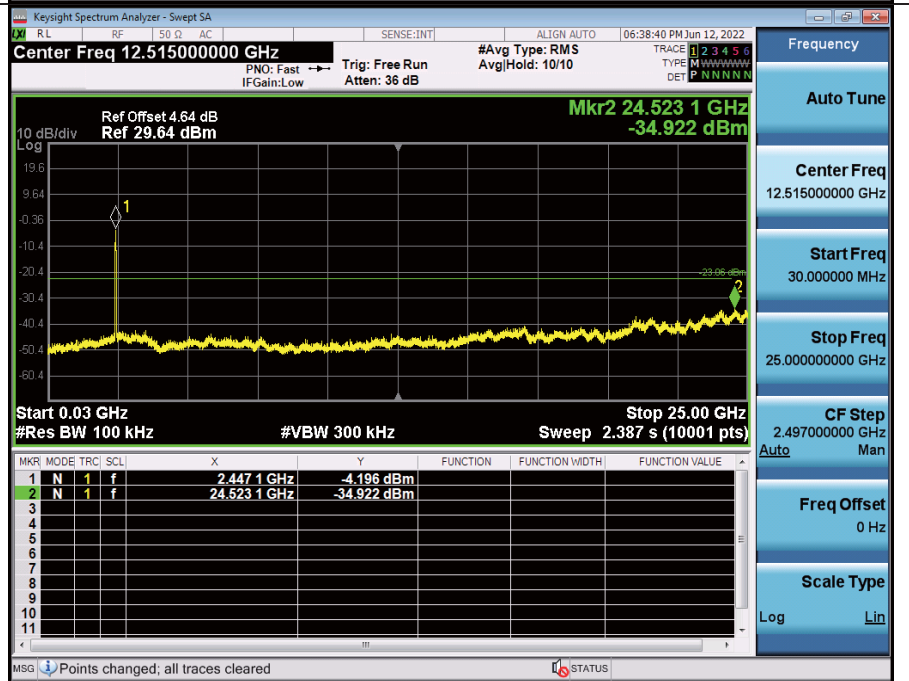
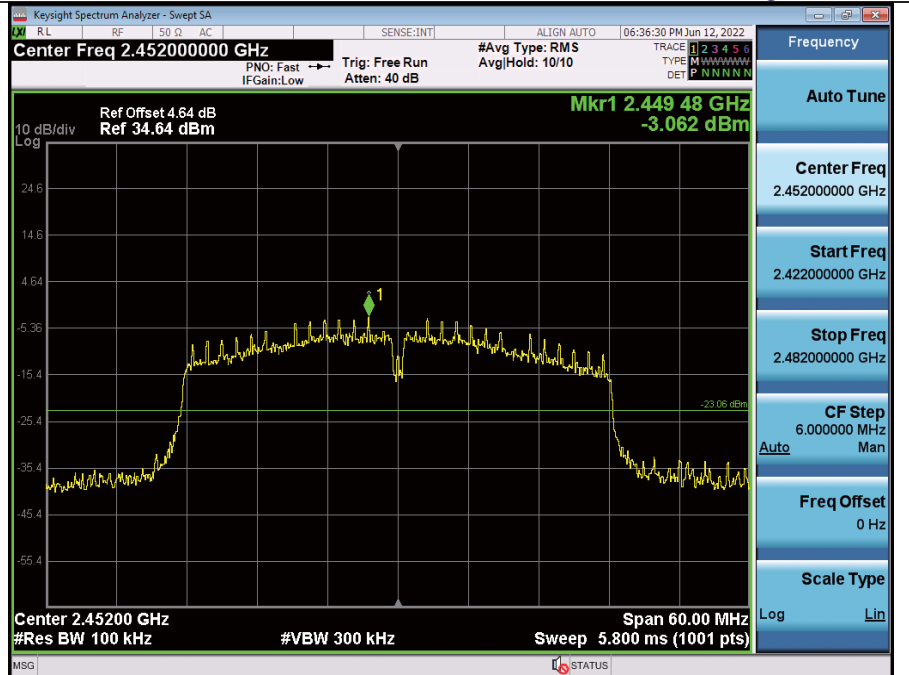



10. ANTENNA REQUIREMENT

Standard requirement:	FCC Part15 C Section 15.203 /247(c)
<p>For intentional device, according to FCC 47 CFR Section 15.203, an intentional radiator shall be designed to ensure that no antenna other than that furnished by the responsible party shall be used with the device. And according to FCC 47 CFR Section 15.247, if transmitting antennas of directional gain greater than 6dBi are used, the power shall be reduced by the amount in dB that the directional gain of the antenna exceeds 6dBi.</p> <p>Refer to statement below for compliance.</p> <p>The manufacturer may design the unit so that the user can replace a broken antenna, but the use of a standard antenna jack or electrical connector is prohibited. Further, this requirement does not apply to intentional radiators that must be professionally installed.</p> <p>Antenna Connected Construction</p> <p>The antenna used in this product are Internal antennas, and the best case gain of the antenna is antenna port 1:2dBi and Antenna port 2:2dBi.</p>	
<p>EUT Antenna:</p> <p>2.4G- ANT1& ANT2</p>  <p>The image shows the internal chassis of a device with two antenna ports. Two arrows point from the text '2.4G- ANT1& ANT2' to the two ports. The left port is labeled 'ANT1' and the right port is labeled 'ANT2'. The ports are small, circular connectors on the metal chassis.</p>	

11. TEST SETUP PHOTO

Reference to the report No.: ZKT-220530L3631-01 for details.

12. EUT CONSTRUCTIONAL DETAILS

Reference to the report No.: ZKT-220530L3631-01 for details.

******* END OF REPORT *******