



### FCC PART 15 SUBPART C TEST REPORT

#### FCC PART 15.247

Report Reference No..... : BSL23090035-P01R02

FCC ID..... : 2A78RNXW-5586

Compiled by  
( position+printed name+signature).. : Engineer/ Cindy Zheng

*Cindy zheng*

Supervised by  
( position+printed name+signature).. : Manager/Haley Wen

*Haley wen*

Approved by  
( position+printed name+signature).. : RF Manager/ Vivian Jiang

*Vivian Jiang*

Date of issue..... : September 22, 2023

Testing Laboratory Name..... : BSL Testing Co., Ltd.

Address..... : 1/F, Building B, Xinshidai GR Park,Shiyan Street, Bao'an District, Shenzhen,Guangdong, 518052, People's Republic of China

Applicant's name..... : Kool Brands, LLC

Address..... : 1450 Vassar Street, RENO, NV 89502, USA

Test specification..... :

Standard..... : FCC Part 15.247

**BSL Testing Co., Ltd. All rights reserved.**

This publication may be reproduced in whole or in part for non-commercial purposes as long as the BSL Testing Co., Ltd. is acknowledged as copyright owner and source of the material. BSL Testing Co., Ltd. takes no responsibility for and will not assume liability for damages resulting from the reader's interpretation of the reproduced material due to its placement and context.

Test item description..... : **Wireless Remote with Action Plus for Wii and Wii U**

Trade Mark..... : N/A

Manufacturer..... : Shenzhen Auzmichain Electronic Co.,Ltd

Model/Type reference..... : NXW-5616

Listed Models ..... : NXW-5609, NXW-5760, NXW-5586, NXW-5593, NXW-6001, NXW-6002, NXW-6003, NXW-6004, NXW-6005, NXW-6006, NXW-6007, NXW-6008, NXW-6009, NXW-6010

Modulation ..... : GFSK, Π/4-DQPSK, 8DPSK

Frequency..... : From 2402MHz to 2480MHz

Rating..... : DC 3V

Result..... : **PASS**

## TEST REPORT

**Equipment under Test** : **Wireless Remote with Action Plus for Wii and Wii U**

Model /Type : NXW-5616

Listed Models : NXW-5609, NXW-5760, NXW-5586, NXW-5593, NXW-6001, NXW-6002, NXW-6003, NXW-6004, NXW-6005, NXW-6006, NXW-6007, NXW-6008, NXW-6009, NXW-6010

Model Declaration : PCB board, structure and internal of these model(s) are the same,So no additional models were tested.

**Applicant** : **Kool Brands, LLC**

Address : 1450 Vassar Street, RENO, NV 89502, USA

**Manufacturer** : **Shenzhen Auzmichain Electronic Co.,Ltd**

Address : 3/F, Building 2, YongQi Science&Technology industrial park, Xixiang, BaoAn,

<b>Test Result:</b>	<b>PASS</b>
---------------------	-------------

The test report merely corresponds to the test sample.  
It is not permitted to copy extracts of these test result without the written permission of the test laboratory.

## Contents

<b>1</b>	<b>TEST STANDARDS .....</b>	<b>4</b>
<b>2</b>	<b>SUMMARY .....</b>	<b>5</b>
2.1	General Remarks	5
2.2	Product Description	5
2.3	Equipment Under Test	5
2.4	Short description of the Equipment under Test (EUT)	5
2.5	EUT operation mode	6
2.6	Block Diagram of Test Setup	6
2.7	Related Submittal(s) / Grant (s)	6
2.8	Modifications	6
<b>3</b>	<b>TEST ENVIRONMENT .....</b>	<b>7</b>
3.1	Address of the test laboratory	7
3.2	Test Facility	7
3.3	Environmental conditions	7
3.4	Summary of measurement results	8
3.5	Statement of the measurement uncertainty	8
3.6	Equipments Used during the Test	9
<b>4</b>	<b>TEST CONDITIONS AND RESULTS .....</b>	<b>11</b>
4.1	AC Power Conducted Emission	11
4.2	Radiated Emission	12
4.3	Maximum Peak Output Power	18
4.4	20dB Bandwidth	21
4.5	Frequency Separation	24
4.6	Number of hopping frequency	26
4.7	Time of Occupancy (Dwell Time)	28
4.8	Out-of-band Emissions	31
4.9	Pseudorandom Frequency Hopping Sequence	37
4.10	Antenna Requirement	38
<b>5</b>	<b>TEST SETUP PHOTOS OF THE EUT .....</b>	<b>39</b>
<b>6</b>	<b>PHOTOS OF THE EUT .....</b>	<b>42</b>

## **1 TEST STANDARDS**

The tests were performed according to following standards:

[FCC Rules Part 15.247](#): Frequency Hopping, Direct Spread Spectrum and Hybrid Systems that are in operation within the bands of 902-928 MHz, 2400-2483.5 MHz, and 5725-5850 MHz.  
[ANSI C63.10-2013](#): American National Standard for Testing Unlicensed Wireless Devices

## 2 SUMMARY

### 2.1 General Remarks

Date of receipt of test sample	:	September 20, 2023
Testing commenced on	:	September 20, 2023
Testing concluded on	:	September 22, 2023

### 2.2 Product Description

Product Name:	Wireless Remote with Action Plus for Wii and Wii U
Model/Type reference:	NXW-5616
Power supply:	DC 3V
Adapter information (Auxiliary test supplied by testing Lab)	N/A
Host information (Auxiliary test supplied by Applicant)	Model: Nintendo Wii/Wii U
Hardware version:	V1.0
Software version:	V1.0
Testing sample ID:	BSL23090035-P01R02-1# (Engineer sample) BSL23090035-P01R02-2# (Normal sample)
<b>Bluetooth :</b>	
Supported Type:	Bluetooth BR/EDR
Modulation:	GFSK, $\pi/4$ DQPSK, 8DPSK
Operation frequency:	2402MHz~2480MHz
Channel number:	79
Channel separation:	1MHz
Antenna type:	PCB Antenna
Antenna gain:	2.5 dBi

### 2.3 Equipment Under Test

#### Power supply system utilised

Power supply voltage	:	<input type="radio"/> 230V / 50 Hz	<input type="radio"/> 120V / 60Hz
		<input checked="" type="radio"/> 3V DC	<input type="radio"/> 24 V DC
		<input type="radio"/> Other (specified in blank below)	

### 2.4 Short description of the Equipment under Test (EUT)

This is a Wireless Remote with Action Plus for Wii and Wii U .  
For more details, refer to the user's manual of the EUT.

## 2.5 EUT operation mode

The Applicant provides communication tools software(Engineer mode) to control the EUT for staying in continuous transmitting (Duty Cycle more than 98%) and receiving mode for testing .There are 79 channels provided to the EUT and Channel 00/39/78 were selected to test.

### Operation Frequency:

Channel	Frequency (MHz)
00	2402
01	2403
⋮	⋮
38	2440
39	2441
40	2442
⋮	⋮
77	2479
78	2480

## 2.6 Block Diagram of Test Setup

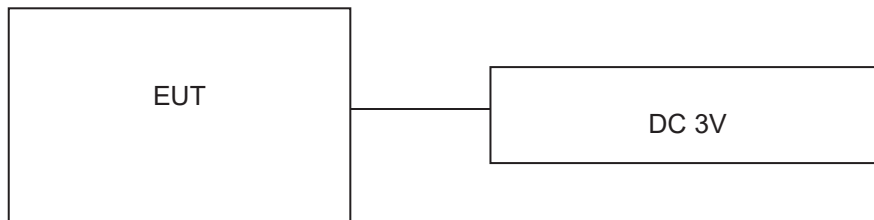

## 2.7 Related Submittal(s) / Grant (s)

This submittal(s) (test report) is intended for the device filing to comply with Section 15.247 of the FCC Part 15, Subpart C Rules.

## 2.8 Modifications

No modifications were implemented to meet testing criteria.

### 3 TEST ENVIRONMENT

#### 3.1 Address of the test laboratory

**BSL Testing Co., Ltd.**

1/F, Building B, Xinshidai GR Park,Shiyan Street, Bao'an District, Shenzhen,Guangdong, 518052, People's Republic of China

#### 3.2 Test Facility

**FCC-Registration No.: 562200 Designation Number: CN1338**

BSL Testing Co.,Ltd. has been listed on the US Federal Communications Commission list of test facilities recognized to perform electromagnetic emissions measurements.

**Industry Canada Registration Number. Is: 11093A CAB identifier: CN0019**

The Laboratory has been registered by Certification and Engineering Bureau of Industry Canada for radio equipment testing.

**A2LA-Lab Cert. No.: 4707.01**

BSL Testing Co.,Ltd. has been listed by American Association for Laboratory Accreditation to perform electromagnetic emission measurement.

The 3m-Semi anechoic test site fulfils CISPR 16-1-4 according to ANSI C63.10 and CISPR 16-1-4:2010.

#### 3.3 Environmental conditions

During the measurement the environmental conditions were within the listed ranges:

Radiated Emission:

Temperature:	24 ° C
Humidity:	45 %
Atmospheric pressure:	950-1050mbar

AC Power Conducted Emission:

Temperature:	25 ° C
Humidity:	46 %
Atmospheric pressure:	950-1050mbar

Conducted testing:

Temperature:	25 ° C
Humidity:	44 %
Atmospheric pressure:	950-1050mbar

### 3.4 Summary of measurement results

Test Specification clause	Test case	Test Mode	Test Channel	Recorded In Report		Test result
§15.247(a)(1)	Carrier Frequency separation	GFSK Π/4DQPSK 8DPSK	<input checked="" type="checkbox"/> Lowest <input checked="" type="checkbox"/> Middle <input checked="" type="checkbox"/> Highest	GFSK Π/4DQPSK 8DPSK	<input checked="" type="checkbox"/> Middle	Compliant
§15.247(a)(1)	Number of Hopping channels	GFSK Π/4DQPSK 8DPSK	<input checked="" type="checkbox"/> Full	GFSK	<input checked="" type="checkbox"/> Full	Compliant
§15.247(a)(1)	Time of Occupancy (dwell time)	GFSK Π/4DQPSK 8DPSK	<input checked="" type="checkbox"/> Lowest <input checked="" type="checkbox"/> Middle <input checked="" type="checkbox"/> Highest	GFSK Π/4DQPSK 8DPSK	<input checked="" type="checkbox"/> Middle	Compliant
§15.247(a)(1)	Spectrum bandwidth of aFHSS system 20dB bandwidth	GFSK Π/4DQPSK 8DPSK	<input checked="" type="checkbox"/> Lowest <input checked="" type="checkbox"/> Middle <input checked="" type="checkbox"/> Highest	GFSK Π/4DQPSK 8DPSK	<input checked="" type="checkbox"/> Lowest <input checked="" type="checkbox"/> Middle <input checked="" type="checkbox"/> Highest	Compliant
§15.247(b)(1)	Maximum output peak power	GFSK Π/4DQPSK 8DPSK	<input checked="" type="checkbox"/> Lowest <input checked="" type="checkbox"/> Middle <input checked="" type="checkbox"/> Highest	GFSK Π/4DQPSK 8DPSK	<input checked="" type="checkbox"/> Lowest <input checked="" type="checkbox"/> Middle <input checked="" type="checkbox"/> Highest	Compliant
§15.247(d)	Band edge compliance conducted	GFSK Π/4DQPSK 8DPSK	<input checked="" type="checkbox"/> Lowest <input checked="" type="checkbox"/> Highest	GFSK Π/4DQPSK 8DPSK	<input checked="" type="checkbox"/> Lowest <input checked="" type="checkbox"/> Highest	Compliant
§15.205	Band edge compliance radiated	GFSK Π/4DQPSK 8DPSK	<input checked="" type="checkbox"/> Lowest <input checked="" type="checkbox"/> Highest	GFSK Π/4DQPSK 8DPSK	<input checked="" type="checkbox"/> Lowest <input checked="" type="checkbox"/> Highest	Compliant
§15.247(d)	TX spurious emissions conducted	GFSK Π/4DQPSK 8DPSK	<input checked="" type="checkbox"/> Lowest <input checked="" type="checkbox"/> Middle <input checked="" type="checkbox"/> Highest	GFSK Π/4DQPSK 8DPSK	<input checked="" type="checkbox"/> Lowest <input checked="" type="checkbox"/> Middle <input checked="" type="checkbox"/> Highest	Compliant
§15.247(d)	TX spurious emissions radiated	GFSK Π/4DQPSK 8DPSK	<input checked="" type="checkbox"/> Lowest <input checked="" type="checkbox"/> Middle <input checked="" type="checkbox"/> Highest	GFSK	<input checked="" type="checkbox"/> Lowest <input checked="" type="checkbox"/> Middle <input checked="" type="checkbox"/> Highest	Compliant
§15.209(a)	TX spurious Emissions radiated Below 1GHz	GFSK Π/4DQPSK 8DPSK	<input checked="" type="checkbox"/> Lowest <input checked="" type="checkbox"/> Middle <input checked="" type="checkbox"/> Highest	GFSK	<input checked="" type="checkbox"/> Middle	Compliant
§15.107(a) §15.207	Conducted Emissions 9KHz-30 MHz	GFSK Π/4DQPSK 8DPSK	<input checked="" type="checkbox"/> Lowest <input checked="" type="checkbox"/> Middle <input checked="" type="checkbox"/> Highest	GFSK	<input checked="" type="checkbox"/> Middle	N/A

Remark:

1. The measurement uncertainty is not included in the test result.
2. We tested all test mode and recorded worst case in report

### 3.5 Statement of the measurement uncertainty

The data and results referenced in this document are true and accurate. The reader is cautioned that there may be errors within the calibration limits of the equipment and facilities. The measurement uncertainty was calculated for all measurements listed in this test report acc. to TR-100028-01 "Electromagnetic compatibility and Radio spectrum Matters (ERM); Uncertainties in the measurement of mobile radio equipment characteristics; Part 1" and TR-100028-02 "Electromagnetic compatibility and Radio spectrum Matters (ERM); Uncertainties in the measurement of mobile radio equipment characteristics; Part 2" and is documented in the BSL Testing Co., Ltd. quality system acc. to DIN EN ISO/IEC 17025. Furthermore, component and process variability of devices similar to that tested may result in additional deviation. The manufacturer has the sole responsibility of continued compliance of the device.

Hereafter the best measurement capability for BSL Testing Co., Ltd.:

Test	Range	Measurement Uncertainty	Notes
Radiated Emission	9KHz~30MHz	3.82 dB	(1)
Radiated Emission	30~1000MHz	4.06 dB	(1)
Radiated Emission	1~18GHz	5.14 dB	(1)
Radiated Emission	18~40GHz	5.38 dB	(1)
Conducted Disturbance	0.15~30MHz	2.14 dB	(1)
Transmitter power conducted	1~40GHz	0.57 dB	(1)
Conducted spurious emission	1~40GHz	1.60 dB	(1)
OBW	1~40GHz	25 Hz	(1)



(1) This uncertainty represents an expanded uncertainty expressed at approximately the 95% confidence level using a coverage factor of k=2.

### 3.6 Equipments Used during the Test

Instrument Type	Manufacturer	Model	Serial No.	Date of Cal.	Due Date
ESPI Test Receiver	ROHDE&SCHWARZ	ESPI 3	100379	2022-10-28	2023-10-27
Absorbing Clamp	ROHDE&SCHWARZ	MDS-21	100126	2022-10-28	2023-10-27
Electrostatic analog generator	LIONCEL	ESD-203B	0210502	2022-10-28	2023-10-27
Signal Generator	HP	8648A	3633A02081	2022-10-28	2023-10-27
Amplifier	A&R	500A100	17034	2022-10-28	2023-10-27
Amplifier	A&R	100W/1000M1	17028	2022-10-28	2023-10-27
Isotropic Field Monitor	A&R	FM2000	16829	2022-10-28	2023-10-27
Isotropic Field Probe	A&R	FLW220100	16755	2022-10-28	2023-10-27
Biconic Antenna	EMCO	EVOD PROTANK8	9507-2534	2022-10-28	2023-10-27
Log-periodic Antenna	A&R	AT1080	16812	2022-10-28	2023-10-27
Injection Clamp	EMTEST	F-2031-23MM	368	2022-10-28	2023-10-27
Attenuator	EMTEST	ATT6	0010222a	2022-10-28	2023-10-27
Computer	IBM	8434	1S8434KCE99BL XLO*	-	-
Oscillator	KENWOOD	AG-203D	3070002	2022-10-28	2023-10-27
Spectrum Analyzer	HAMEG	HM5012	-	-	-
Power Supply	LW	APS1502	-	-	-
5K VA AC Power Source	California Instruments	5001iX	56060	2022-10-28	2023-10-27
CDN	EM TEST	CDN M2/M3	-	2022-10-28	2023-10-27
Attenuation	EM TEST	ATT6/75	-	2022-10-28	2023-10-27
Resistance	EM TEST	R100	-	2022-10-28	2023-10-27
Electromagnetic Injection Clamp	LITTHI	EM101	35708	2022-10-28	2023-10-27
Inductive Components	EM TEST	MC2630	-	2022-10-28	2023-10-27
Antenna	EM TEST	MS100	-	2022-10-28	2023-10-27
Signal Generator	ROHDE&SCHWARZ	SMT03	100029	2022-10-28	2023-10-27
Power DJ MIXER	AR	150W1000	300999	2022-10-28	2023-10-27
Field probe	Holaday	HI-6005	105152	2022-10-28	2023-10-27
Bilog Antenna	Chase	CBL6111C	2576	2022-10-28	2023-10-27
Loop Antenna	EMCO	6502	00042960	2022-10-28	2023-10-27
ESPI Test Receiver	ROHDE&SCHWARZ	ESI7	838786/013	2022-10-28	2023-10-27
3m OATS	--	--	N/A	2022-10-28	2023-10-27
Horn Antenna	SCHWARZBECK	VULB9168	N/A	2022-10-28	2023-10-27
Horn Antenna	SCHWARZBECK	BBHA9120D	N/A	2022-10-28	2023-10-27
Power meter	Anritsu	ML2487A	6K00003613	2022-10-28	2023-10-27
Power sensor	Anritsu	MA2491A	32263	2022-10-28	2023-10-27
Bilog Antenna	Schwarzbeck	VULB9163	9163/340	2022-10-28	2023-10-27
9*6*6 Anechoic	--	--	N/A	2021-08-21	2024-8-20
Test Receiver	Rohde&Schwarz	ESC17(9kHz-7GHz)	100336	2022-10-28	2023-10-27
Broadband antenna	Schwarzbeck	VULB9168	01222	2022-10-28	2023-10-27
Horn antenna	Schwarzbeck	BBHA9120D	02476	2022-10-28	2023-10-27

Preamplifier	Schwarzbeck	BBV9745	00250	2022-10-28	2023-10-27
Preamplifier	N/A	TRLA-01018G440B	21081001	2022-10-28	2023-10-27
3M method semi anechoic chamber	SKET	9m*6m*6m	2021082304	2021-8-23	2024-8-22
Pointer hygrometer	M&G	ARC92570	N/A	2022-10-28	2023-10-27
Spectrometer	ROHDE&SCHWARZ	FSP 9kHz-40GHz	N/A	2022-10-28	2023-10-27
Synthesizer	ROHDE&SCHWARZ	CMW500	N/A	2022-10-28	2023-10-27
LISN	R&S	ENV216	308	2022-10-28	2023-10-27
LISN	R&S	ENV216	314	2022-10-28	2023-10-27

## 4 TEST CONDITIONS AND RESULTS

### 4.1 AC Power Conducted Emission

#### TEST CONFIGURATION

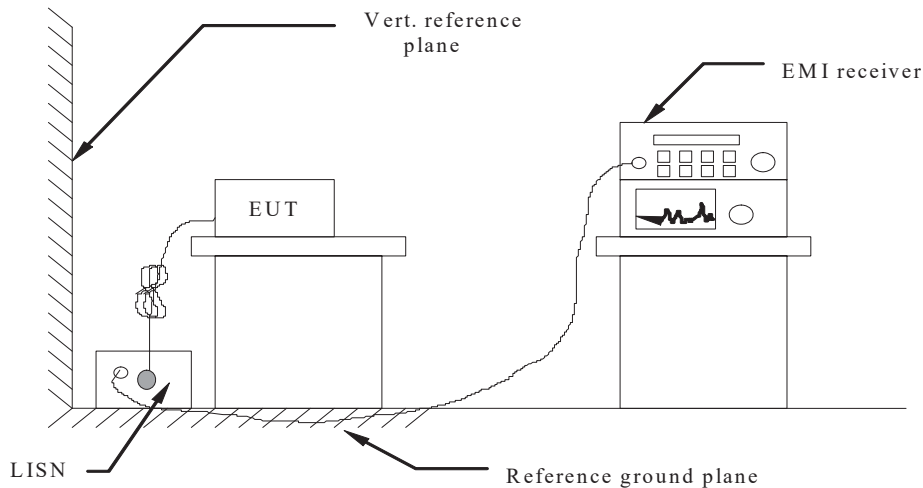

#### TEST PROCEDURE

- 1 The equipment was set up as per the test configuration to simulate typical actual usage per the user's manual. The EUT is a tabletop system, a wooden table with a height of 0.8 meters is used and is placed on the ground plane as per ANSI C63.10-2013.
- 2 Support equipment, if needed, was placed as per ANSI C63.10-2013
- 3 All I/O cables were positioned to simulate typical actual usage as per ANSI C63.10-2013
- 4 The EUT received power from adapter, the adapter received AC120V/60Hz and AC 240V/60Hz power through a Line Impedance Stabilization Network (LISN) which supplied power source and was grounded to the ground plane.
- 5 All support equipments received AC power from a second LISN, if any.
- 6 The EUT test program was started. Emissions were measured on each current carrying line of the EUT using a spectrum Analyzer / Receiver connected to the LISN powering the EUT. The LISN has two monitoring points: Line 1 (Hot Side) and Line 2 (Neutral Side). Two scans were taken: one with Line 1 connected to Analyzer / Receiver and Line 2 connected to a 50 ohm load; the second scan had Line 1 connected to a 50 ohm load and Line 2 connected to the Analyzer / Receiver.
- 7 Analyzer / Receiver scanned from 150 KHz to 30MHz for emissions in each of the test modes.
- 8 During the above scans, the emissions were maximized by cable manipulation.

#### AC Power Conducted Emission Limit

For intentional device, according to § 15.207(a) AC Power Conducted Emission Limits is as following:

Frequency range (MHz)	Limit (dBuV)	
	Quasi-peak	Average
0.15-0.5	66 to 56*	56 to 46*
0.5-5	56	46
5-30	60	50

\* Decreases with the logarithm of the frequency.

#### TEST RESULTS

The EUT is Powered by the Battery, So this test item is not applicable for the EUT.

## 4.2 Radiated Emission

### TEST CONFIGURATION

Frequency range 9KHz – 30MHz

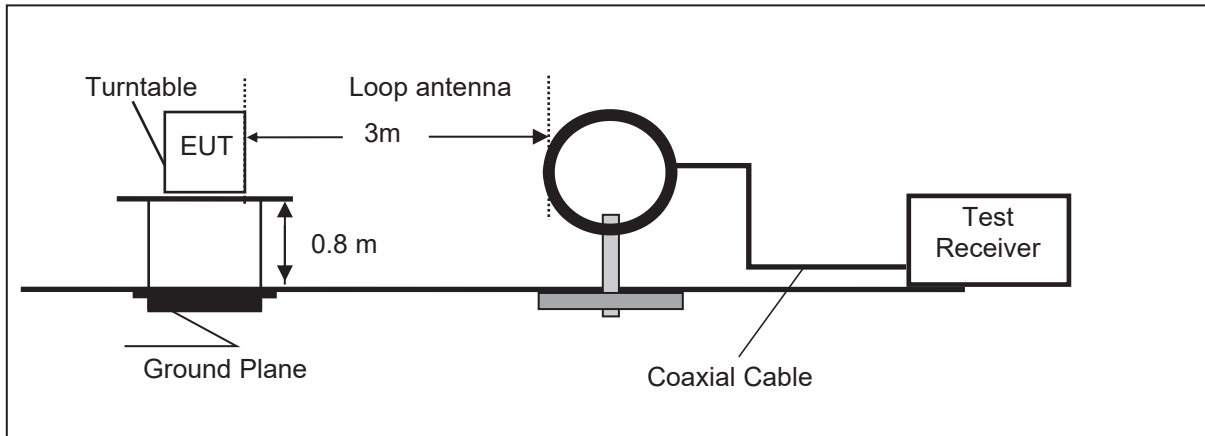

Frequency range 30MHz – 1000MHz

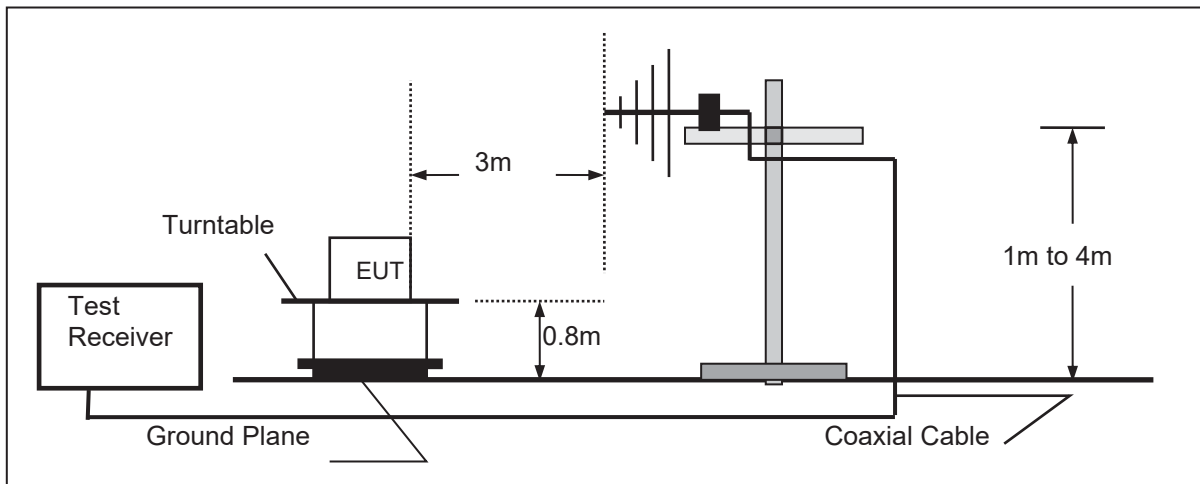

Frequency range above 1GHz-25GHz

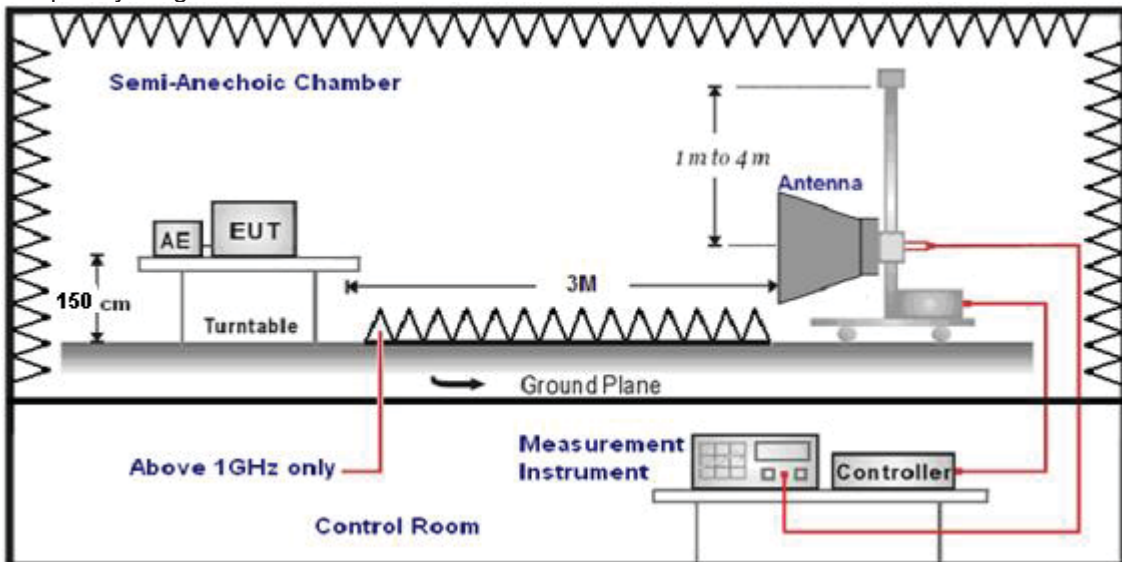

**TEST PROCEDURE**

1. The EUT was placed on a turn table which is 0.8m above ground plane when testing frequency range 9 KHz –1GHz;the EUT was placed on a turn table which is 1.5m above ground plane when testing frequency range 1GHz – 25GHz.
2. Maximum procedure was performed by raising the receiving antenna from 1m to 4m and rotating the turn table from 0° to 360° to acquire the highest emissions from EUT.
3. And also, each emission was to be maximized by changing the polarization of receiving antenna both horizontal and vertical.
4. Repeat above procedures until all frequency measurements have been completed.
5. Radiated emission test frequency band from 9KHz to 25GHz.
6. The distance between test antenna and EUT as following table states:

Test Frequency range	Test Antenna Type	Test Distance
9KHz-30MHz	Active Loop Antenna	3
30MHz-1GHz	Ultra-Broadband Antenna	3
1GHz-18GHz	Double Ridged Horn Antenna	3
18GHz-25GHz	Horn Antenna	1

7. Setting test receiver/spectrum as following table states:

Test Frequency range	Test Receiver/Spectrum Setting	Detector
9KHz-150KHz	RBW=200Hz/VBW=3KHz, Sweep time=Auto	QP
150KHz-30MHz	RBW=9KHz/VBW=100KHz, Sweep time=Auto	QP
30MHz-1GHz	RBW=120KHz/VBW=1000KHz, Sweep time=Auto	QP
1GHz-40GHz	Peak Value: RBW=1MHz/VBW=3MHz, Sweep time=Auto Average Value: RBW=1MHz/VBW=10Hz, Sweep time=Auto	Peak

**Field Strength Calculation**

The field strength is calculated by adding the Antenna Factor and Cable Factor and subtracting the Amplifier Gain and Duty Cycle Correction Factor(if any) from the measured reading. The basic equation with a sample calculation is as follows:

$$FS = RA + AF + CL - AG$$

Where FS = Field Strength	CL = Cable Attenuation Factor (Cable Loss)
RA = Reading Amplitude	AG = Amplifier Gain
AF = Antenna Factor	

$$Transd=AF +CL-AG$$

**RADIATION LIMIT**

For intentional device, according to § 15.209(a), the general requirement of field strength of radiated emission from intentional radiators at a distance of 3 meters shall not exceed the following table. According to § 15.247(d), in any 100kHz bandwidth outside the frequency band in which the EUT is operating, the radio frequency power that is produced by the intentional radiator shall be at least 20dB below that in the100kHz bandwidth within the band that contains the highest level of desired power.

The pre-test have done for the EUT in three axes and found the worst emission at position shown in test setup photos.

Frequency (MHz)	Distance (Meters)	Radiated (dBµV/m)	Radiated (µV/m)
0.009-0.49	3	20log(2400/F(KHz))+40log(300/3)	2400/F(KHz)
0.49-1.705	3	20log(24000/F(KHz))+ 40log(30/3)	24000/F(KHz)
1.705-30	3	20log(30)+ 40log(30/3)	30
30-88	3	40.0	100
88-216	3	43.5	150
216-960	3	46.0	200
Above 960	3	54.0	500

**TEST RESULTS**

Remark:

1. This test was performed with EUT in X, Y, Z position and the worse case was found when EUT in X position.
2. We measured Radiated Emission at GFSK, π/4-DQPSK and 8DPSK mode from 9 KHz to 25GHz and recorded worst case at GFSK DH5 mode.
3. For below 1GHz testing recorded worst at GFSK DH5 middle channel.
4. Radiated emission test from 9 KHz to 10th harmonic of fundamental was verified, and no emission found except system noise floor in 9 KHz to 30MHz and not recorded in this report.

**For 30MHz-1GHz**

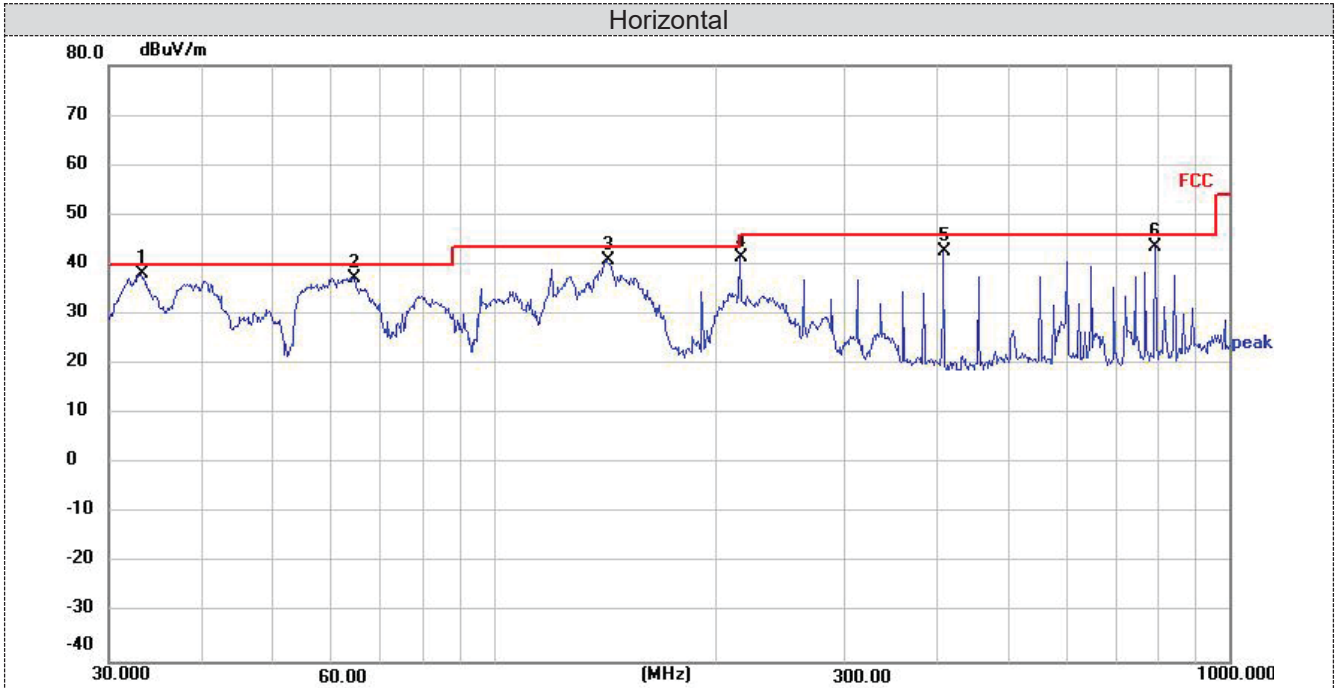

No.	Frequency (MHz)	Reading (dBuV)	Factor (dB/m)	Level (dBuV/m)	Limit (dBuV/m)	Margin (dB)	Detector
1 *	33.2112	55.29	-17.10	38.19	40.00	-1.81	peak
2	64.6594	55.13	-17.80	37.33	40.00	-2.67	peak
3	142.8243	57.32	-16.53	40.79	43.50	-2.71	peak
4	216.0239	60.81	-19.34	41.47	46.00	-4.53	peak
5	408.9459	55.62	-12.84	42.78	46.00	-3.22	peak
6	793.3958	48.13	-4.69	43.44	46.00	-2.56	peak

Note: 1). Level (dBμV/m)= Reading (dBμV/m)+ Factor (dB/m)  
 2). Factor(dB/m)=Antenna Factor (dB/m) + Cable loss (dB) - Pre Amplifier gain (dB)  
 3). Margin(dB) = Limit (dBμV/m) - Level (dBμV/m)



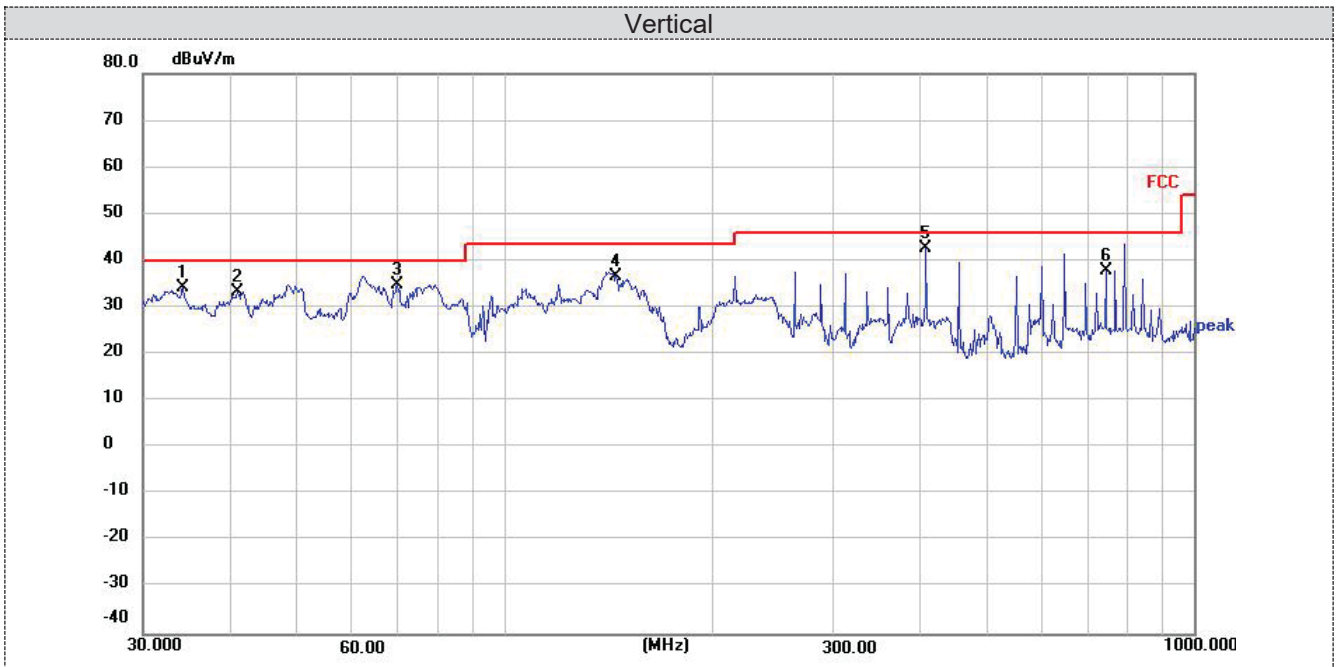

No.	Frequency (MHz)	Reading (dBuV)	Factor (dB/m)	Level (dBuV/m)	Limit (dBuV/m)	Margin (dB)	Detector
1	34.2760	51.36	-17.09	34.27	40.00	-5.73	peak
2	41.1319	49.66	-16.33	33.33	40.00	-6.67	peak
3	70.0901	53.64	-18.67	34.97	40.00	-5.03	peak
4	145.3505	53.01	-16.32	36.69	43.50	-6.81	peak
5 *	408.9458	55.60	-12.84	42.76	46.00	-3.24	peak
6	744.8659	43.33	-5.44	37.89	46.00	-8.11	peak

- Note:1).Level (dBuV/m)= Reading (dBuV/m)+ Factor (dB/m)  
 2). Factor(dB/m)=Antenna Factor (dB/m) + Cable loss (dB) - Pre Amplifier gain (dB)  
 3). Margin(dB) = Limit (dBuV/m) - Level (dBuV/m)

**For 1GHz to 25GHz**

Note: GFSK,  $\pi/4$ -DQPSK and 8-DPSK all have been tested, only worse case GFSK is reported.

**GFSK (above 1GHz)**

Frequency(MHz):			2402		Polarity:		HORIZONTAL		
Frequency (MHz)	Emission Level (dBuV/m)		Limit (dBuV/m)	Margin (dB)	Raw Value (dBuV)	Antenna Factor (dB/m)	Cable Factor (dB)	Pre-amplifier (dB)	Correction Factor (dB/m)
4804.00	56.69	PK	74	17.31	61.05	32.40	5.11	41.87	-4.36
4804.00	46.88	AV	54	7.12	51.24	32.40	5.11	41.87	-4.36
7206.00	55.65	PK	74	18.35	56.28	36.58	6.43	43.64	-0.63
7206.00	45.72	AV	54	8.28	46.35	36.58	6.43	43.64	-0.63

Frequency(MHz):			2402		Polarity:		VERTICAL		
Frequency (MHz)	Emission Level (dBuV/m)		Limit (dBuV/m)	Margin (dB)	Raw Value (dBuV)	Antenna Factor (dB/m)	Cable Factor (dB)	Pre-amplifier (dB)	Correction Factor (dB/m)
4804.00	56.89	PK	74	17.11	61.25	32.40	5.11	41.87	-4.36
4804.00	46.88	AV	54	7.12	51.24	32.40	5.11	41.87	-4.36
7206.00	55.62	PK	74	18.38	56.25	36.58	6.43	43.64	-0.63
7206.00	46.26	AV	54	7.74	46.89	36.58	6.43	43.64	-0.63

Frequency(MHz):			2441		Polarity:		HORIZONTAL		
Frequency (MHz)	Emission Level (dBuV/m)		Limit (dBuV/m)	Margin (dB)	Raw Value (dBuV)	Antenna Factor (dB/m)	Cable Factor (dB)	Pre-amplifier (dB)	Correction Factor (dB/m)
4882.00	57.33	PK	74	16.67	61.28	32.56	5.34	41.85	-3.95
4882.00	47.64	AV	54	6.36	51.59	32.56	5.34	41.85	-3.95
7323.00	55.88	PK	74	18.12	56.24	36.54	6.81	43.71	-0.36
7323.00	45.29	AV	54	8.71	45.65	36.54	6.81	43.71	-0.36

Frequency(MHz):			2441		Polarity:		VERTICAL		
Frequency (MHz)	Emission Level (dBuV/m)		Limit (dBuV/m)	Margin (dB)	Raw Value (dBuV)	Antenna Factor (dB/m)	Cable Factor (dB)	Pre-amplifier (dB)	Correction Factor (dB/m)
4882.00	57.61	PK	74	16.39	61.56	32.56	5.34	41.85	-3.95
4882.00	47.19	AV	54	6.81	51.14	32.56	5.34	41.85	-3.95
7323.00	56.49	PK	74	17.51	56.85	36.54	6.81	43.71	-0.36
7323.00	46.33	AV	54	7.67	46.69	36.54	6.81	43.71	-0.36

Frequency(MHz):			2480		Polarity:		HORIZONTAL		
Frequency (MHz)	Emission Level (dBuV/m)		Limit (dBuV/m)	Margin (dB)	Raw Value (dBuV)	Antenna Factor (dB/m)	Cable Factor (dB)	Pre-amplifier (dB)	Correction Factor (dB/m)
4960.00	57.79	PK	74	16.21	61.25	32.73	5.64	41.83	-3.46
4960.00	47.90	AV	54	6.10	51.36	32.73	5.64	41.83	-3.46
7440.00	55.42	PK	74	18.58	55.48	36.50	7.23	43.79	-0.06
7440.00	46.15	PK	54	7.85	46.21	36.50	7.23	43.79	-0.06

Frequency(MHz):			2480		Polarity:		VERTICAL		
Frequency (MHz)	Emission Level (dBuV/m)		Limit (dBuV/m)	Margin (dB)	Raw Value (dBuV)	Antenna Factor (dB/m)	Cable Factor (dB)	Pre-amplifier (dB)	Correction Factor (dB/m)
4960.00	57.92	PK	74	16.08	61.38	32.73	5.64	41.83	-3.46
4960.00	47.80	AV	54	6.20	51.26	32.73	5.64	41.83	-3.46
7440.00	56.42	PK	74	17.58	56.48	36.50	7.23	43.79	-0.06
7440.00	46.53	PK	54	7.47	46.59	36.50	7.23	43.79	-0.06



**REMARKS:**

1. Emission level (dBuV/m) =Raw Value (dBuV)+Correction Factor (dB/m)
2. Correction Factor (dB/m) = Antenna Factor (dB/m)+Cable Factor (dB)- Pre-amplifier
3. Margin value = Limit value- Emission level.
4. -- Mean the PK detector measured value is below average limit.
5. The other emission levels were very low against the limit.

**Results of Band Edges Test (Radiated)**

Note: GFSK, Pi/4 DQPSK and 8-DPSK all have been tested, only worse case GFSK is reported.

**GFSK**

Frequency(MHz):			2402		Polarity:		HORIZONTAL		
Frequency (MHz)	Emission Level (dBuV/m)		Limit (dBuV/m)	Margin (dB)	Raw Value (dBuV)	Antenna Factor (dB/m)	Cable Factor (dB)	Pre-amplifier (dB)	Correction Factor (dB/m)
2390.00	51.72	PK	74	22.28	62.14	27.42	4.31	42.15	-10.42
2390.00	49.79	AV	54	4.21	60.21	27.42	4.31	42.15	-10.42
Frequency(MHz):			2402		Polarity:		VERTICAL		
Frequency (MHz)	Emission Level (dBuV/m)		Limit (dBuV/m)	Margin (dB)	Raw Value (dBuV)	Antenna Factor (dB/m)	Cable Factor (dB)	Pre-amplifier (dB)	Correction Factor (dB/m)
2390.00	47.79	PK	74	26.21	58.21	27.42	4.31	42.15	-10.42
2390.00	45.82	AV	54	8.18	56.24	27.42	4.31	42.15	-10.42
Frequency(MHz):			2480		Polarity:		HORIZONTAL		
Frequency (MHz)	Emission Level (dBuV/m)		Limit (dBuV/m)	Margin (dB)	Raw Value (dBuV)	Antenna Factor (dB/m)	Cable Factor (dB)	Pre-amplifier (dB)	Correction Factor (dB/m)
2483.50	45.58	PK	74	28.42	55.69	27.70	4.47	42.28	-10.11
2483.50	43.30	AV	54	10.70	53.41	27.70	4.47	42.28	-10.11
Frequency(MHz):			2480		Polarity:		VERTICAL		
Frequency (MHz)	Emission Level (dBuV/m)		Limit (dBuV/m)	Margin (dB)	Raw Value (dBuV)	Antenna Factor (dB/m)	Cable Factor (dB)	Pre-amplifier (dB)	Correction Factor (dB/m)
2483.50	41.17	PK	74	32.83	51.28	27.70	4.47	42.28	-10.11
2483.50	39.57	AV	54	14.43	49.68	27.70	4.47	42.28	-10.11

**REMARKS:**

1. Emission level (dBuV/m) =Raw Value (dBuV)+Correction Factor (dB/m)
2. Correction Factor (dB/m) = Antenna Factor (dB/m)+Cable Factor (dB)- Pre-amplifier
3. Margin value = Limit value- Emission level.
4. -- Mean the PK detector measured value is below average limit.
5. The other emission levels were very low against the limit.

### 4.3 Maximum Peak Output Power

#### Limit

The Maximum Peak Output Power Measurement is 20.97dBm

#### Test Procedure

1. Remove the antenna from the EUT and then connect a low RF cable from the antenna port to the spectrum.
2. Set the spectrum analyzer: RBW = 3MHz. VBW = 8MHz. Sweep = auto; Detector Function = Peak.
3. Keep the EUT in transmitting at lowest, medium and highest channel individually. Record the max value.

#### Test Configuration



#### Test Results

Type	Channel	Output power (dBm)	Limit (dBm)	Result
GFSK	00	-2.680	20.97	Pass
	39	-2.570		
	78	-2.747		
π/4DQPSK	00	-1.071	20.97	Pass
	39	-0.690		
	78	-1.077		
8-DPSK	00	-0.754	20.97	Pass
	39	-0.638		
	78	-0.792		

Note: 1.The test results including the cable lose.

Test plots

GFSK(CH00)



$\pi/4$ DQPSK (CH00)



GFSK(CH39)



$\pi/4$ DQPSK (CH39)



GFSK(CH78)



$\pi/4$ DQPSK (CH78)



8-DPSK(CH00)



8-DPSK(CH39)



8-DPSK(CH78)



#### 4.4 20dB Bandwidth

##### Limit

For frequency hopping systems operating in the 2400MHz-2483.5MHz no limit for 20dB bandwidth.

##### Test Procedure

The transmitter output was connected to the spectrum analyzer through an attenuator. The bandwidth of the fundamental frequency was measured by spectrum analyzer with 30 KHz RBW and 100 KHz VBW.

The 20dB bandwidth is defined as the total spectrum the power of which is higher than peak power minus 20dB.

##### Test Configuration



##### Test Results

Modulation	Channel	20dB bandwidth (MHz)	Result
GFSK	CH00	0.721	Pass
	CH39	0.721	
	CH78	0.720	
$\pi/4$ DQPSK	CH00	1.220	
	CH39	1.220	
	CH78	1.217	
8-DPSK	CH00	1.209	
	CH39	1.209	
	CH78	1.210	

Test plot as follows:



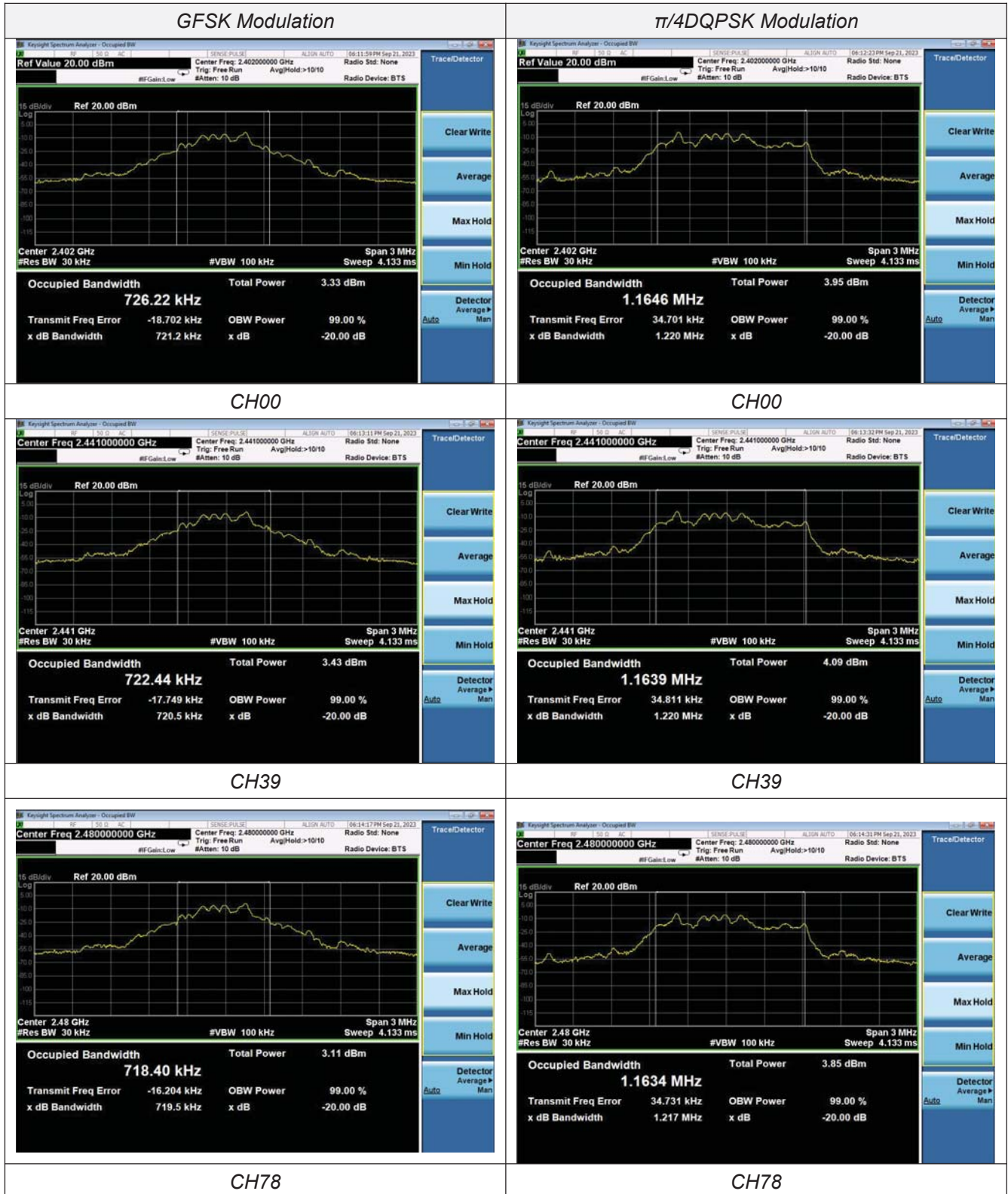

8-DPSK Modulation

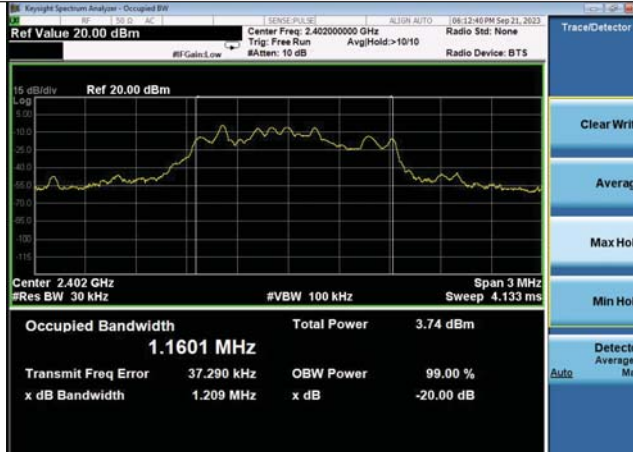

CH00



CH39

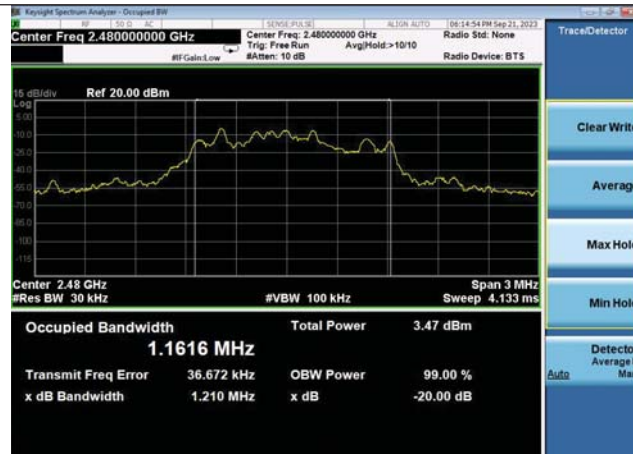

CH78

## 4.5 Frequency Separation

### LIMIT

According to 15.247(a)(1), frequency hopping systems shall have hopping channel carrier frequencies separated by minimum of 25KHz or the  $\frac{2}{3} * 20\text{dB}$  bandwidth of the hopping channel, whichever is greater.

### TEST PROCEDURE

The transmitter output was connected to the spectrum analyzer through an attenuator. The bandwidth of the fundamental frequency was measured by spectrum analyzer with 100 KHz RBW and 300 KHz VBW.

### TEST CONFIGURATION



### TEST RESULTS

Modulation	Channel	Channel Separation (MHz)	Limit(MHz)	Result
GFSK	CH38	1.004	0.481	Pass
	CH39			
$\pi/4$ DQPSK	CH38	1.002	0.813	Pass
	CH39			
8-DPSK	CH38	1.004	0.806	Pass
	CH39			

Note:

We have tested all mode at high, middle and low channel, and recorded worst case at middle

Test plot as follows:





GFSK



$\pi/4$ DQPSK



8-DPSK

#### 4.6 Number of hopping frequency

**Limit**

Frequency hopping systems in the 2400–2483.5 MHz band shall use at least 15 channels.

**Test Procedure**

The transmitter output was connected to the spectrum analyzer through an attenuator. Set spectrum analyzer start 2400MHz to 2483.5MHz with 100 KHz RBW and 300 KHz VBW.

**Test Configuration**



**Test Results**

Modulation	Number of Hopping Channel	Limit	Result
GFSK	79	≥15	Pass
$\pi/4$ DQPSK	79		
8-DPSK	79		

**Test plot as follows:**

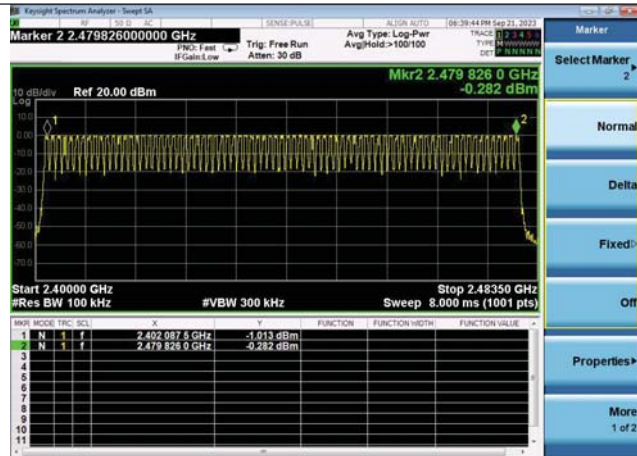

GFSK Modulation

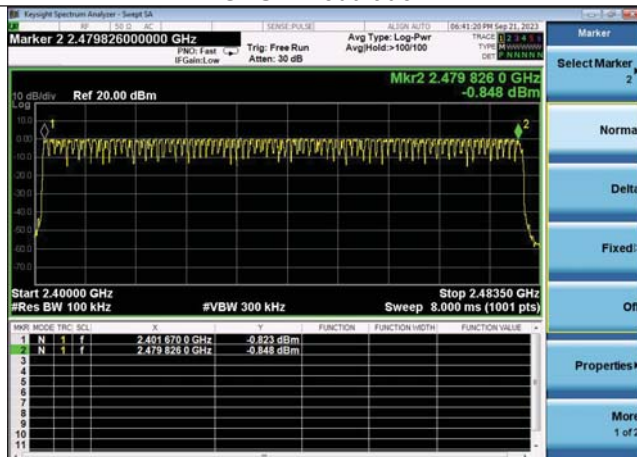

$\pi/4$ DQPSK Modulation

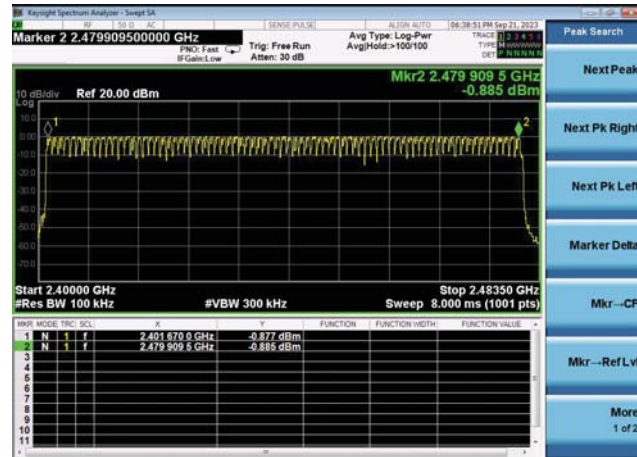

8-DPSK Modulation

### 4.7 Time of Occupancy (Dwell Time)

**Limit**

The average time of occupancy on any channel shall not be greater than 0.4 seconds within a period of 0.4 seconds multiplied by the number of hopping channels employed.

**Test Procedure**

The transmitter output was connected to the spectrum analyzer through an attenuator. Set center frequency of spectrum analyzer=operating frequency with 1MHz RBW and 3MHz VBW, Span 0Hz.

**Test Configuration**



**Test Results**

Modulation	Packet	Burst time (ms)	Dwell time (s)	Limit (s)	Result
GFSK	DH1	0.384	0.123	0.40	Pass
	DH3	1.624	0.260		
	DH5	2.824	0.301		
π/4DQPSK	2-DH1	0.400	0.128	0.40	Pass
	2-DH3	1.624	0.260		
	2-DH5	2.904	0.310		
8-DPSK	3-DH1	0.392	0.125	0.40	Pass
	3-DH3	1.632	0.261		
	3-DH5	2.720	0.290		

Note: We have tested all mode at high, middle and low channel, and recorded worst case at middle channel.

Dwell time = Pulse time (ms) × (1600 ÷ 2 ÷ 79) × 31.6 Second for DH1, 2-DH1, 3-DH1

Dwell time = Pulse time (ms) × (1600 ÷ 4 ÷ 79) × 31.6 Second for DH3, 2-DH3, 3-DH2

Dwell time = Pulse time (ms) × (1600 ÷ 6 ÷ 79) × 31.6 Second for DH5, 2-DH5, 3-DH3

Test plot as follows:

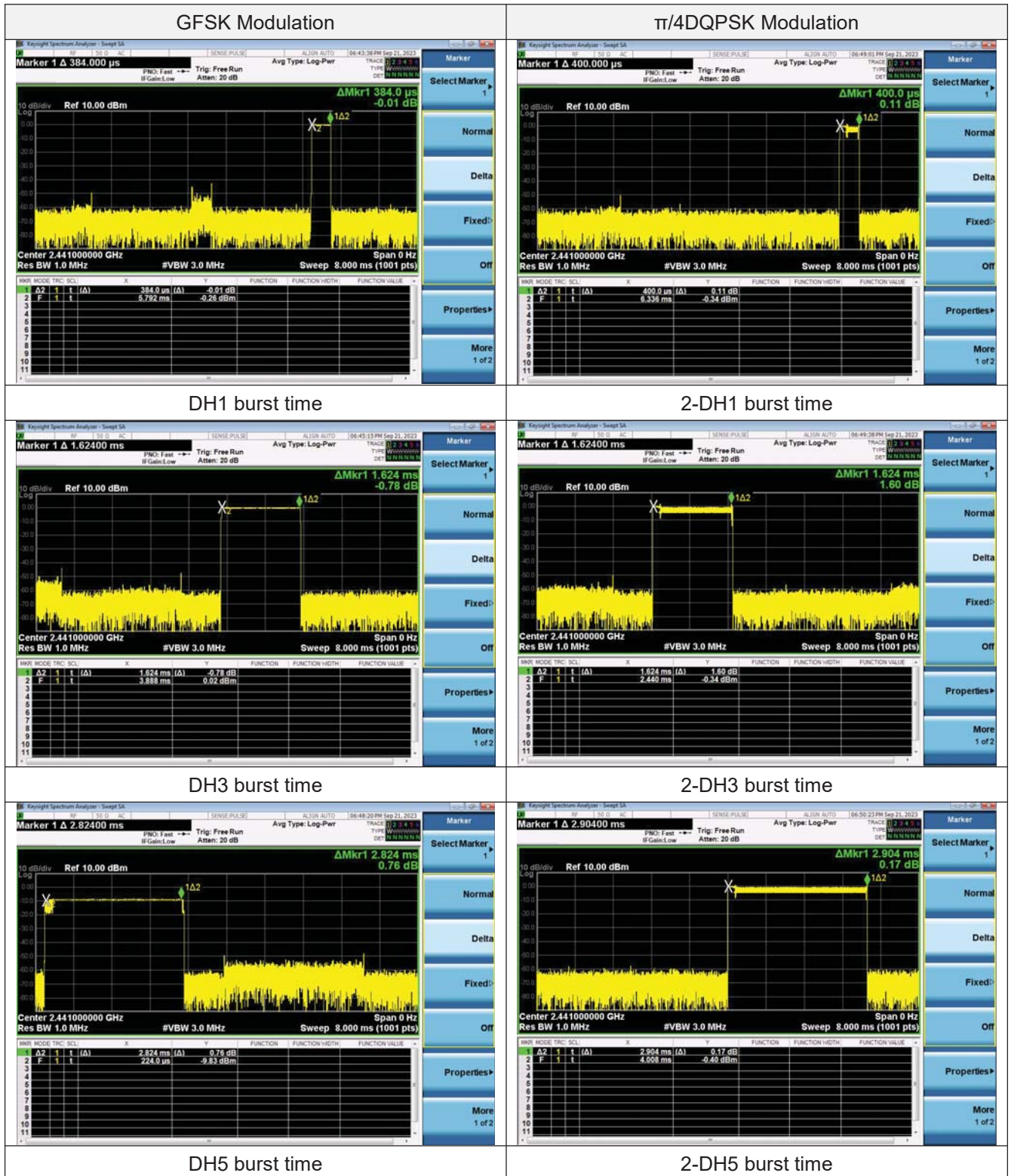



8-DPSK Modulation

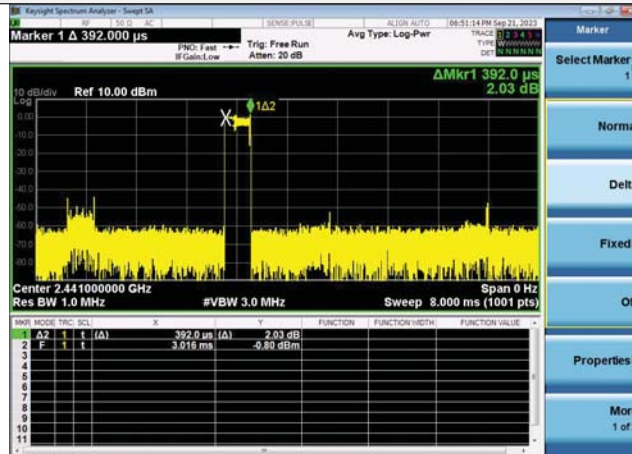

3-DH1 burst time

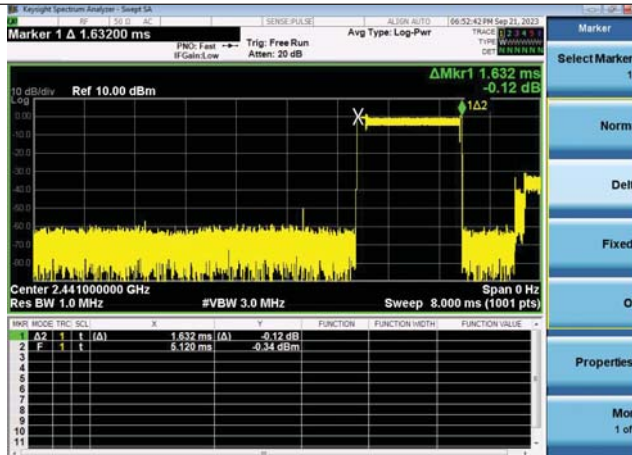

3-DH3 burst time

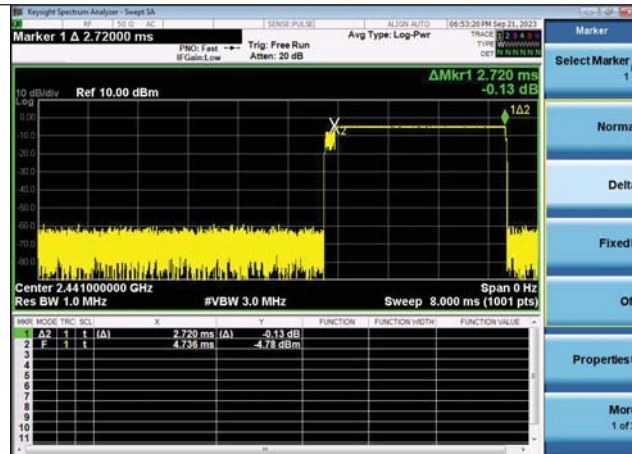

3-DH5 burst time

## 4.8 Out-of-band Emissions

### Limit

In any 100 kHz bandwidth outside the frequency band in which the spread spectrum or digitally modulated intentional radiator is operating, the radio frequency power that is produced by the intentional radiator shall be at least 20 dB below that in the 100 kHz bandwidth within the band that contains the highest level of the desired power, based on either an RF conducted or a radiated measurement, provided the transmitter demonstrates compliance with the peak conducted power limits. If the transmitter complies with the conducted power limits based on the use of RMS averaging over a time interval, as permitted under paragraph (b)(3) of this section, the attenuation required under this paragraph shall be 30 dB instead of 20 dB. Attenuation below the general limits specified in §15.209(a) is not required.

### Test Procedure

Connect the transmitter output to spectrum analyzer using a low loss RF cable, and set the spectrum analyzer to RBW=100 kHz, VBW= 300 kHz, peak detector, and max hold. Measurements utilizing these settings are made of the in-band reference level, bandedge and out-of-band emissions.

### Test Configuration



### Test Results

Remark: The measurement frequency range is from 30MHz to the 10th harmonic of the fundamental frequency. The lowest, middle and highest channels are tested to verify the spurious emissions and bandedge measurement data.

We measured all conditions (DH1, DH3, DH5) and recorded worst case at DH5

Test plot as follows:

30MHz-25G

GFSK(CH00)

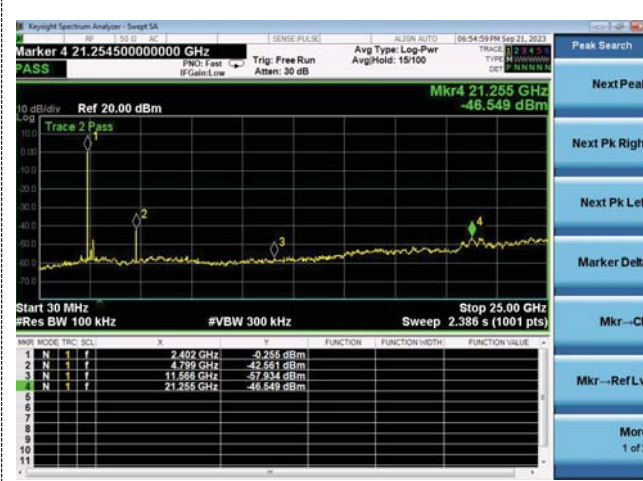

$\pi/4$ DQPSK (CH00)



GFSK(CH39)

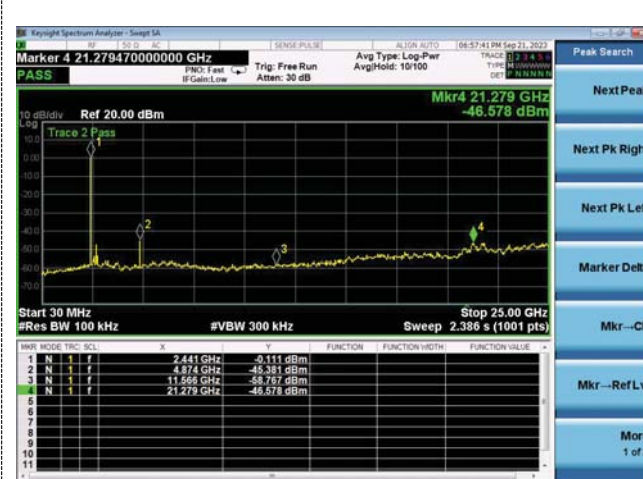

$\pi/4$ DQPSK (CH39)



GFSK(CH78)



$\pi/4$ DQPSK (CH78)





**8-DPSK(CH00)**

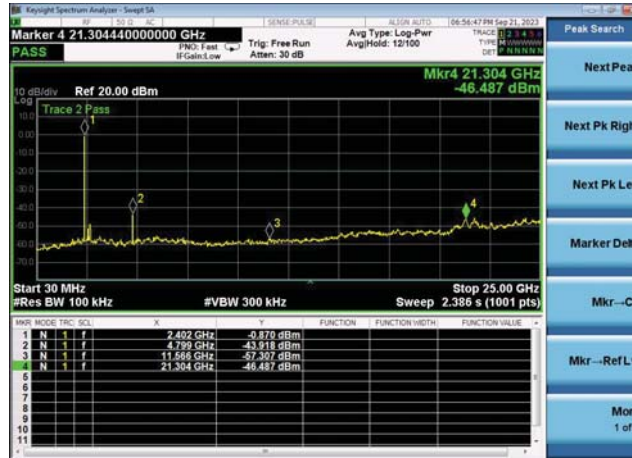

**8-DPSK(CH39)**

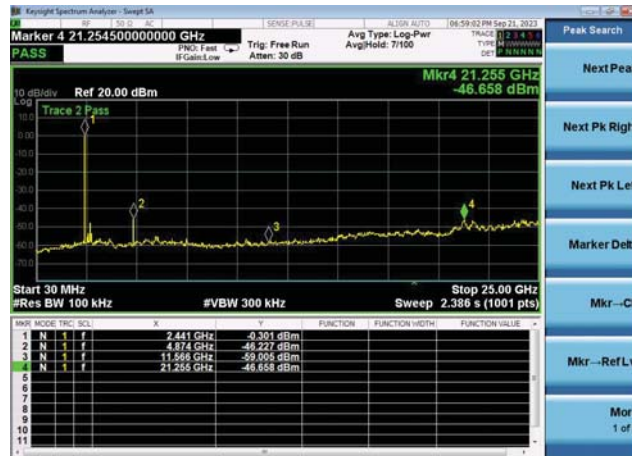

**8-DPSK(CH78)**

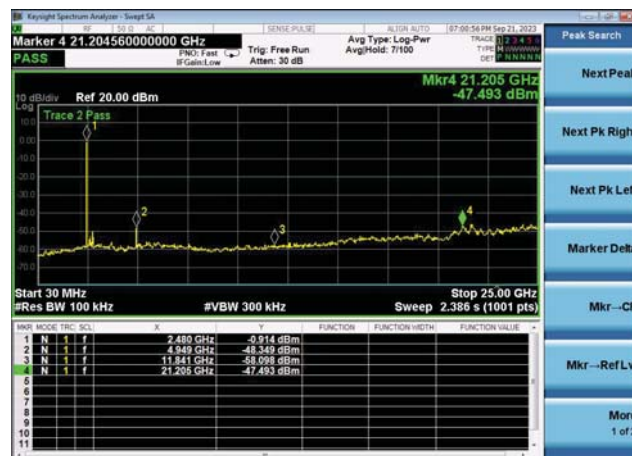

**Band-edge Measurements for RF Conducted Emissions:  
GFSK**

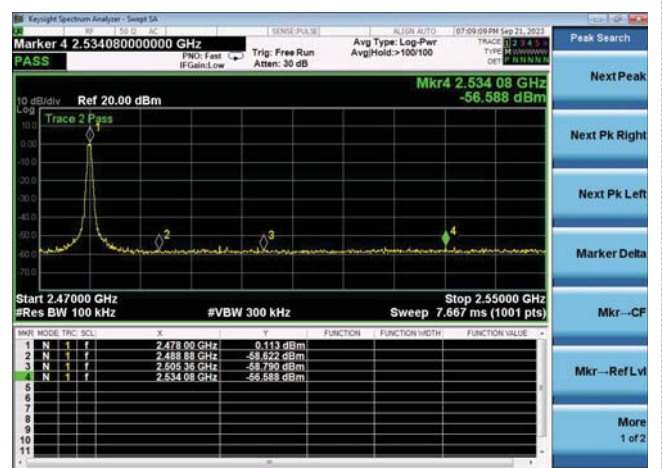
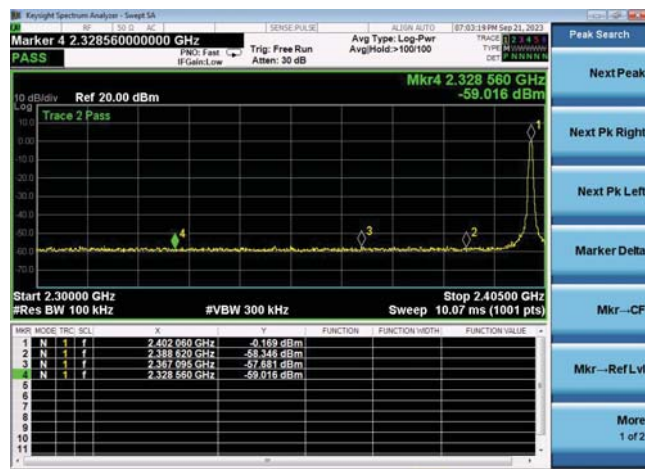

Left Band edge hopping off

Right Band edge hopping off

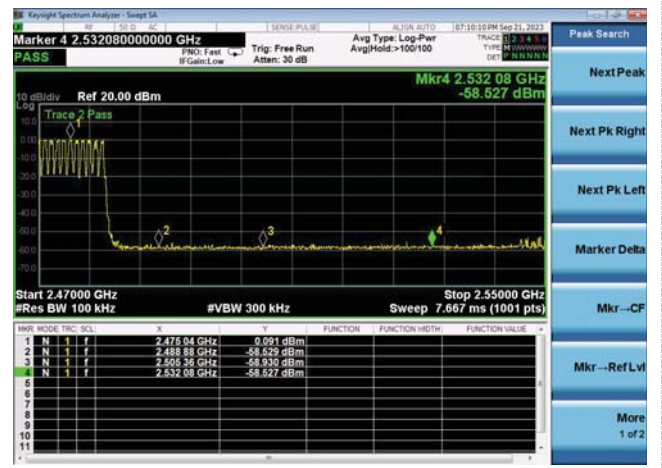
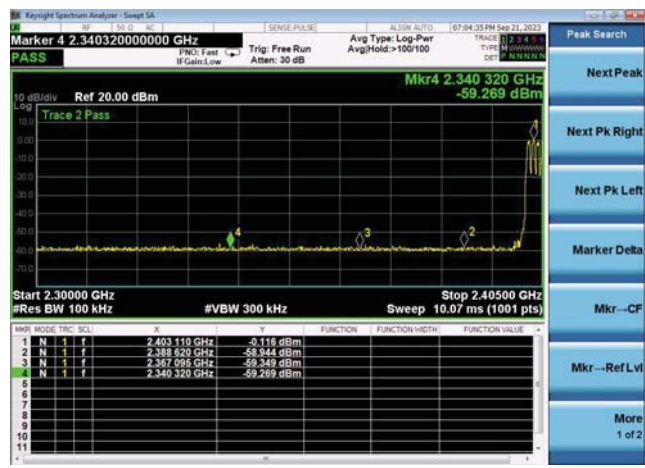

Left Band edge hopping on

Right Band edge hopping on

$\pi/4$ DQPSK

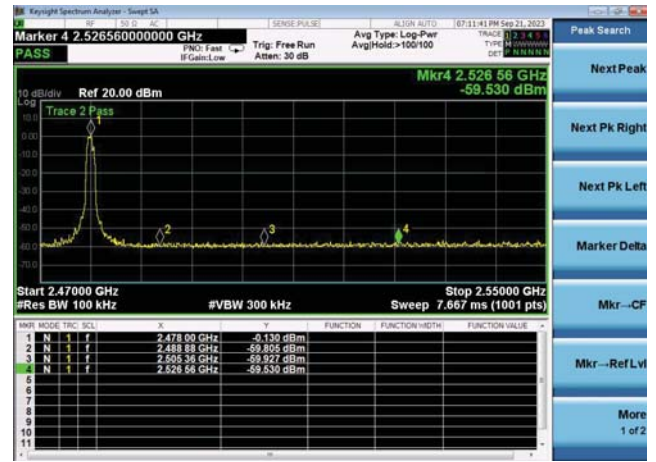
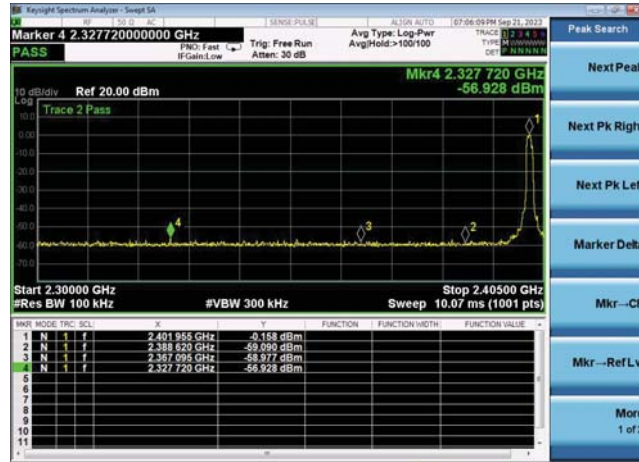

Left Band edge hopping off

Right Band edge hopping off

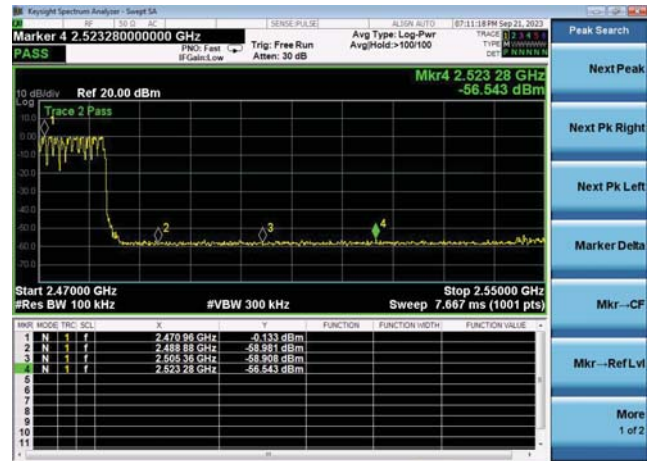
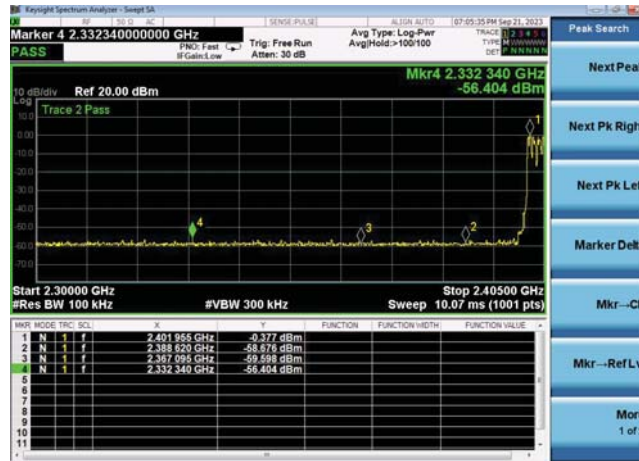

Left Band edge hopping on

Right Band edge hopping on



## 8-DPSK

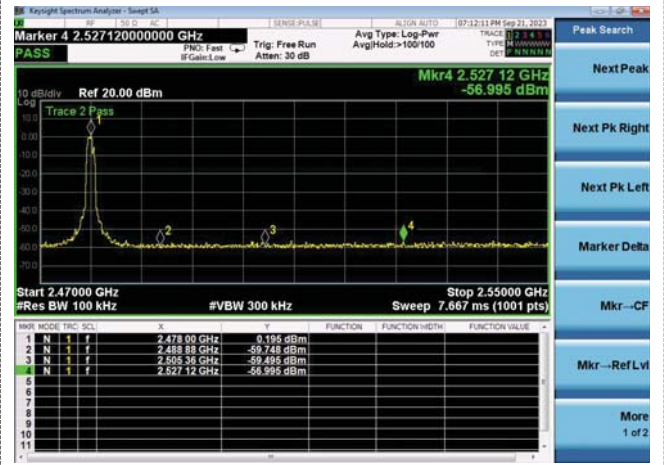
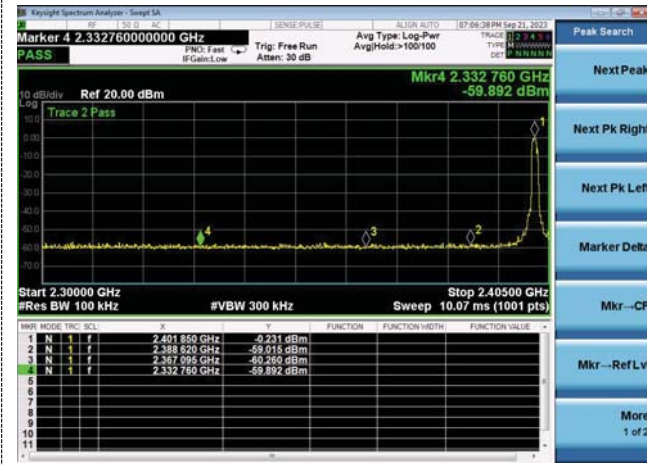

Left Band edge hopping off

Right Band edge hopping off

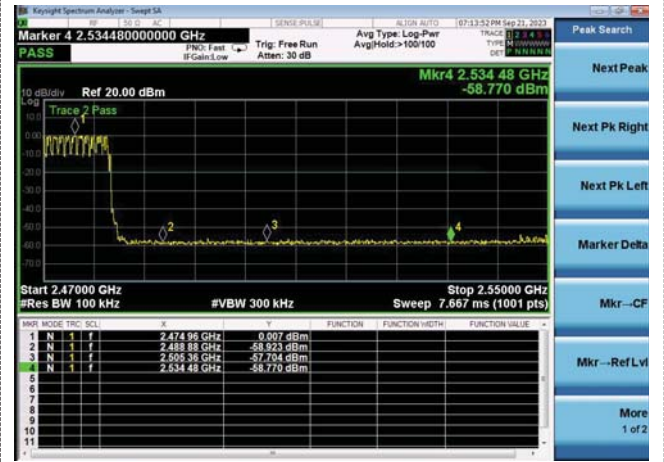
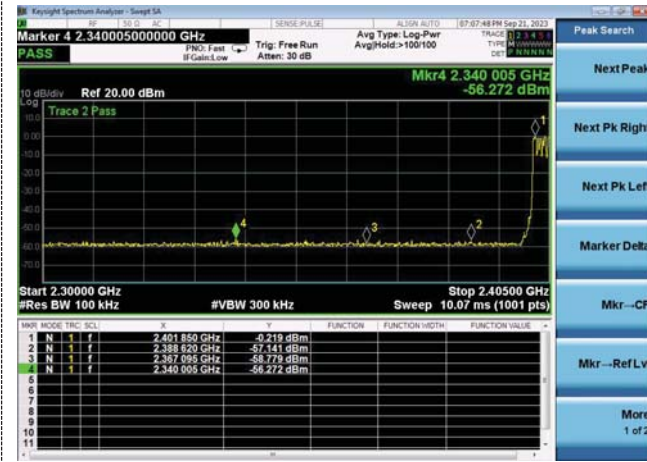

Left Band edge hopping on

Right Band edge hopping on

### 4.9 Pseudorandom Frequency Hopping Sequence

#### TEST APPLICABLE

#### **For 47 CFR Part 15C section 15.247 (a) (1) requirement:**

Frequency hopping systems shall have hopping channel carrier frequencies separated by a minimum of 25 kHz or the 20 dB bandwidth of the hop-ping channel, whichever is greater. Alternatively, frequency hopping systems operating in the 2400–2483.5 MHz band may have hopping channel carrier frequencies that are separated by 25 kHz or two-thirds of the 20 dB bandwidth of the hopping channel, whichever is greater, provided the systems operate with an output power no greater than 125 mW. The system shall hop to channel frequencies that are selected at the system hopping rate from a pseudo randomly ordered list of hopping frequencies. Each frequency must be used equally on the average by each transmitter. The system receivers shall have input bandwidths that match the hop-ping channel bandwidths of their corresponding transmitters and shall shift frequencies in synchronization with the transmitted signals.

#### **EUT Pseudorandom Frequency Hopping Sequence Requirement**

The pseudorandom frequency hopping sequence may be generated in a nine-stage shift register whose 5<sup>th</sup> and 9<sup>th</sup> stage outputs are added in a modulo-two addition stage. And the result is fed back to the input of the first stage. The sequence begins with the first one of 9 consecutive ones, for example: the shift register is initialized with nine ones.

- Number of shift register stages:9
- Length of pseudo-random sequence:29-1=511 bits
- Longest sequence of zeros:8(non-inverted signal)

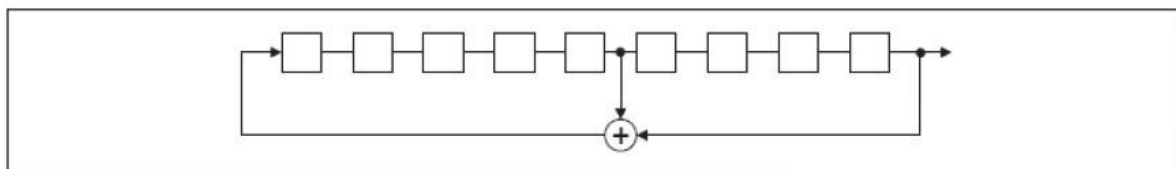

*Linear Feedback Shift Register for Generation of the PRBS sequence*

An example of pseudorandom frequency hopping sequence as follows:

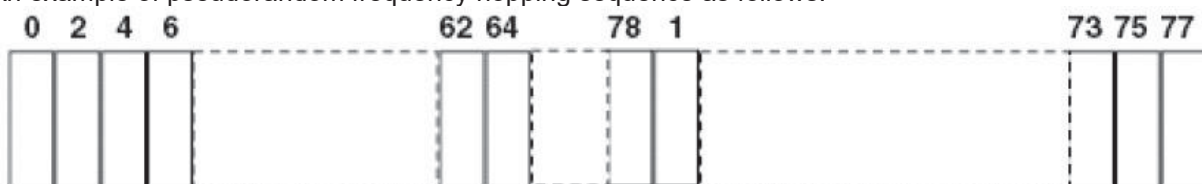

Each frequency used equally one the average by each transmitter.

The system receiver have input bandwidths that match the hopping channel bandwidths of their corresponding transmitter and shift frequencies in synchronization with the transmitted signals.

## **4.10 Antenna Requirement**

### **Standard Applicable**

For intentional device, according to FCC 47 CFR Section 15.203, an intentional radiator shall be designed to ensure that no antenna other than that furnished by the responsible party shall be used with the device. And according to FCC 47 CFR Section 15.247 (c), if transmitting antennas of directional gain greater than 6dBi are used, the power shall be reduced by the amount in dB that the directional gain of the antenna exceeds 6dBi.

### **Refer to statement below for compliance**

The manufacturer may design the unit so that the user can replace a broken antenna, but the use of a standard antenna jack or electrical connector is prohibited. Further, this requirement does not apply to intentional radiators that must be professionally installed.

### **Antenna Connected Construction**

The maximum gain of antenna is 2.5 dBi.

Remark: The antenna gain is provided by the customer, if the data provided by the customer is not accurate, BSL Testing Co., Ltd. does not assume any responsibility.

## **5 Test Setup Photos of the EUT**



## **6 Photos of the EUT**

**Reference to the report ANNEX A of external photos and ANNEX B of internal photos.**

**\*\*\*\*\* End of Report \*\*\*\*\***