

RT-8252 Antenna Report

Date	Description	Author	Note
20220718	Initial release	Tony.Zhong	None

1. Antenna Description:

Antenna type	Monopole antenna
Model name	RT-8252
Antenna gain	4dBi(Typical)
Frequency range	2.4GHz~2.5GHz
Connector type	PCB
Location of measurement	SHENZHEN RTI-TEK CO.,LTD

2. Antenna Model

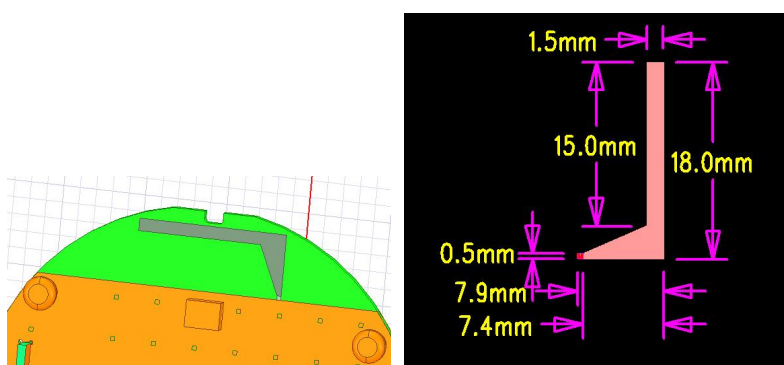

3. Antenna Specification

3.1 VSWR

Frequency	S11
2.4GHz~2.5GHz	<-10dB

S11:

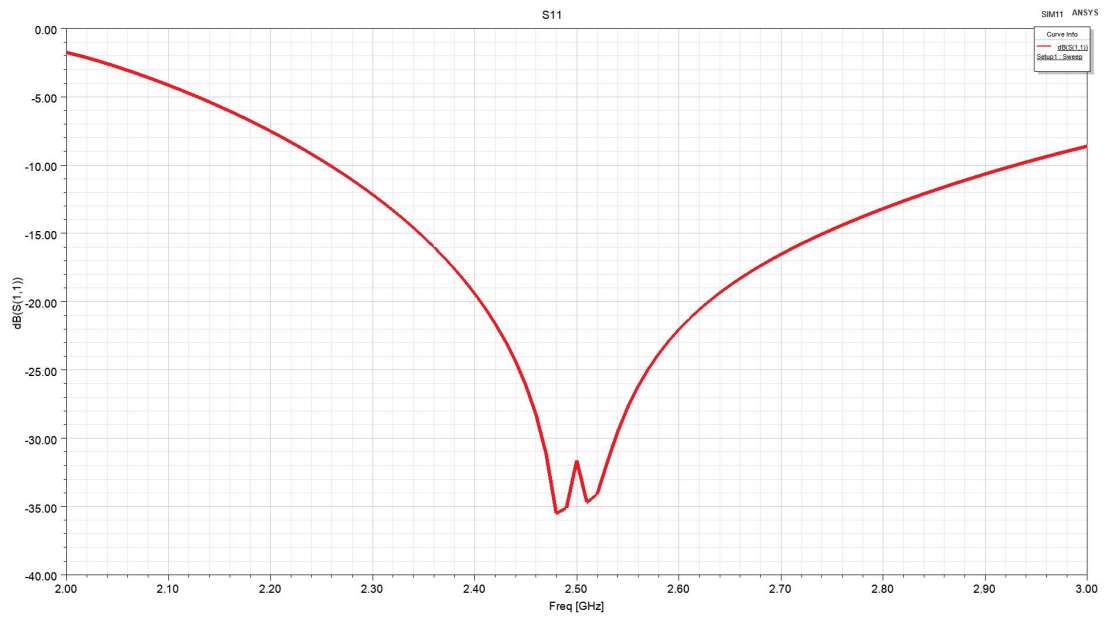

3.2 Gain

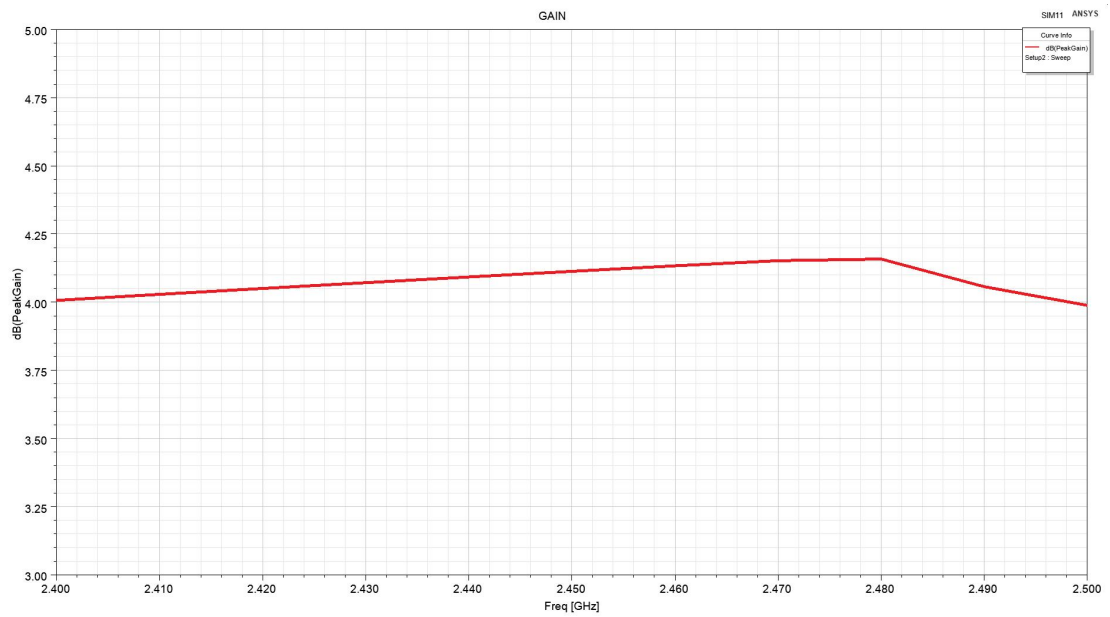

3.3 Efficiency

Radiation efficiency is more than 75%.

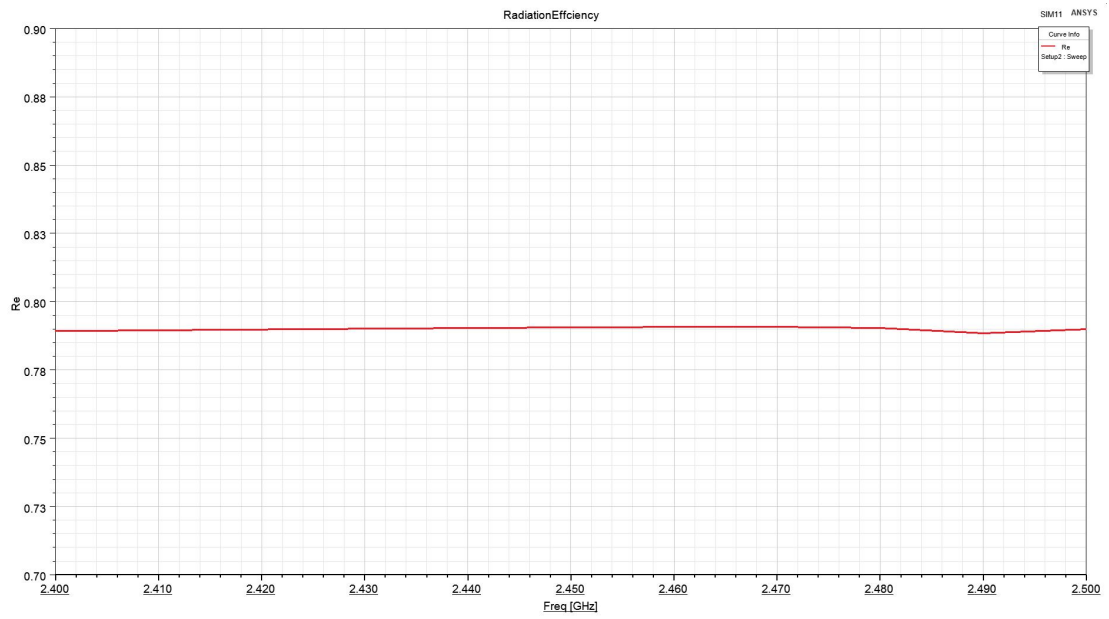

3.4 Antenna Radiation Pattern

3.4.1 3D Pattern

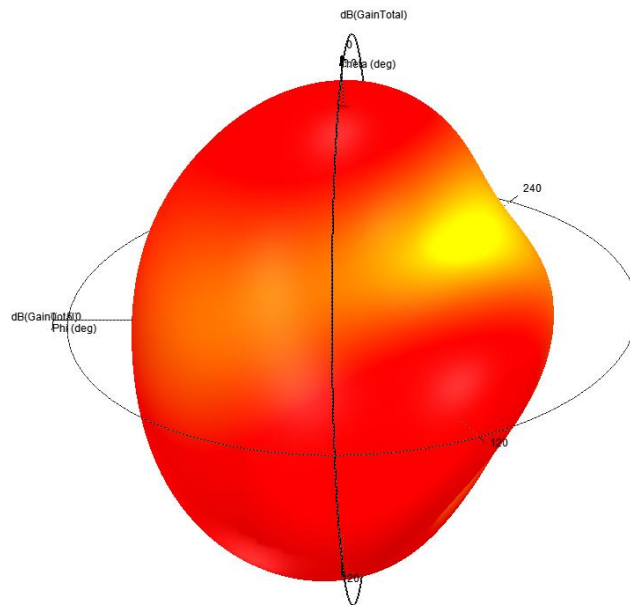

3.4.2 2D Pattern

Theta=90°

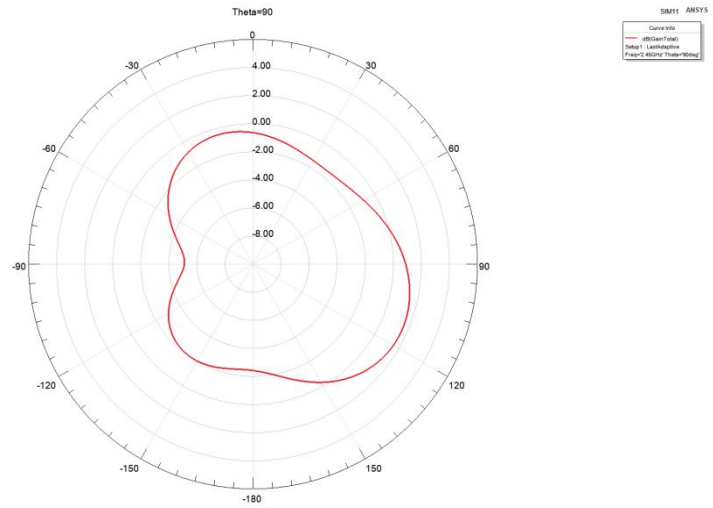

Phi=0°

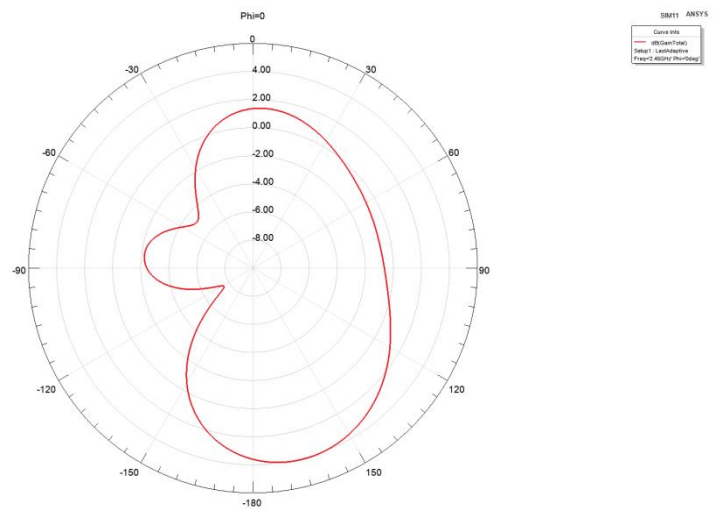

Phi=90°

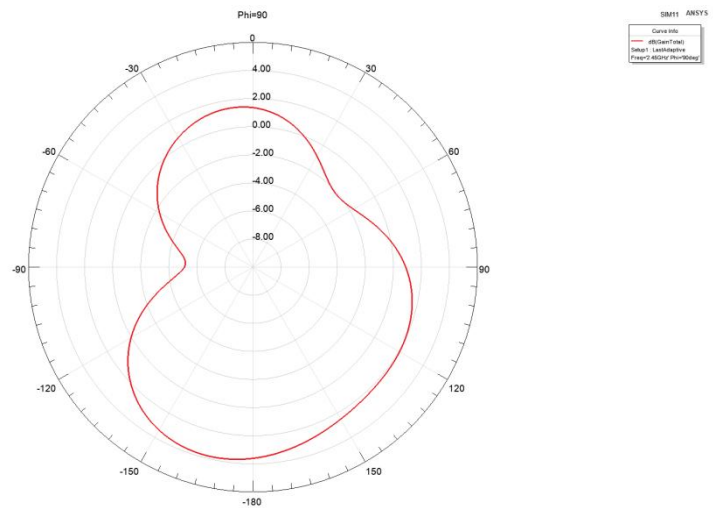

4. Summary

All indexes of the antenna meet the requirements.