

材质:80g书写纸, 胶装双面印刷
单页尺寸: 140 *140mm (共112页)

PETKIT

USER MANUAL

PETKIT YUMSHARE SOLO WITH CAMERA
SMART PET FEEDER

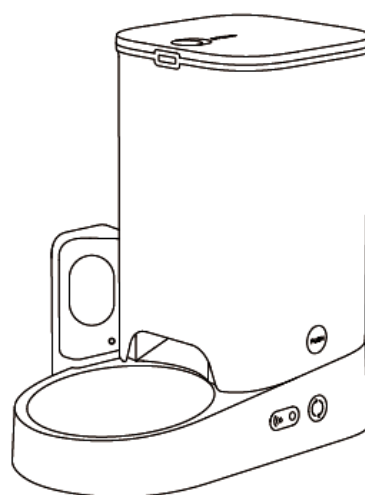

Please read the User Manual carefully before using
the product and keep it properly.

TABLE OF CONTENTS

Product List	3
Product Description	4
Product Installation	5,6
How to Use	7,8
Cleaning and Maintenance	9,10
Video Guide	10
Basic Specifications	11
A Message to Our Valued Customers	12
User Safety Guide	12

01 PRODUCT LIST

***Please confirm the accessories before installation and use.
(Batteries or screwdrivers are not equipped and need to be purchased separately)**

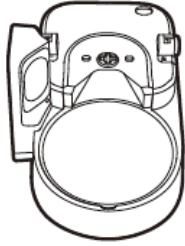

Main Unit

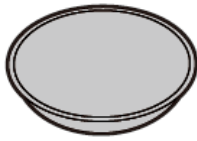

Food Bowl

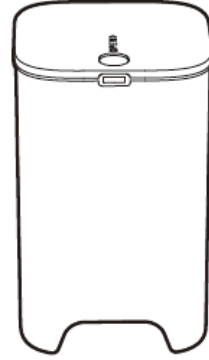

Food Storage Container

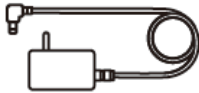

Adapter

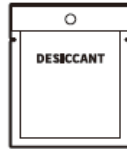

Desiccant



User Manual

*Note: in order to provide a better user experience, we will be implementing periodic product enhancements. Product images shown for illustration purpose only. Actual product may vary from the image shown on the box. For any discrepancies, please refer to the actual product.

02 PRODUCT DESCRIPTION

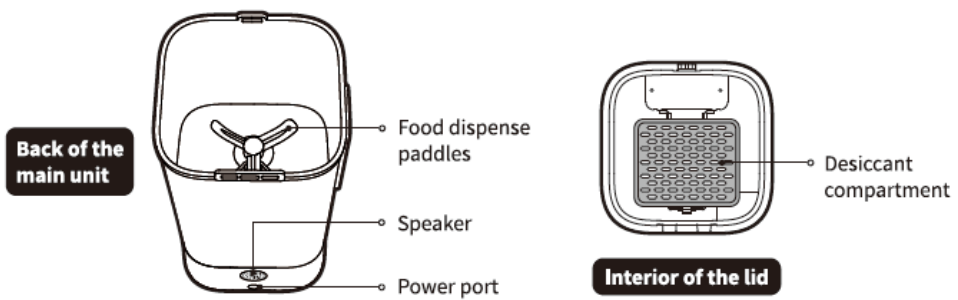
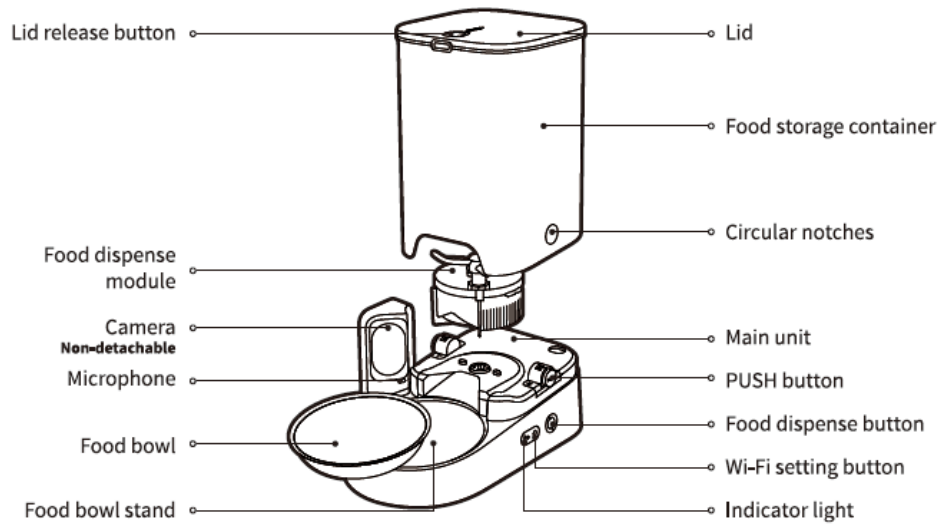

03 PRODUCT INSTALLATION

3.1 Install the main unit

- ① Place the main unit on the level ground or desk.
- ② Lift the food storage container, align the circular notches on both sides of the container with the PUSH button on the main unit, and place it vertically downwards.
- ③ Press and hold the PUSH buttons until they are fully stuck into the circular notches.
- ④ Place the food bowl in the food bowl stand.

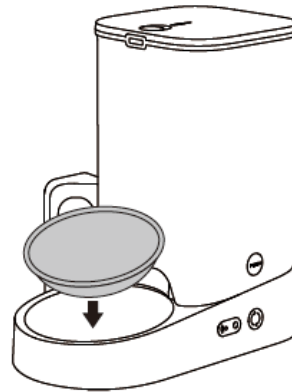
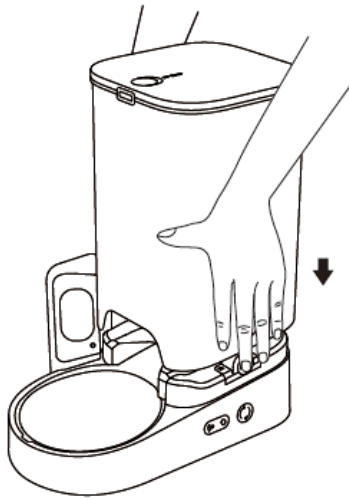

3.2 Connect the power supply

Take out the power adapter cord and attach it to the power adapter port on the back.

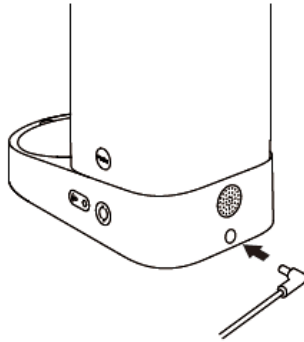

3.4 Install the desiccant

① Press and hold the lid release button and slide to the right as shown in the picture, and lift it up to remove the lid.

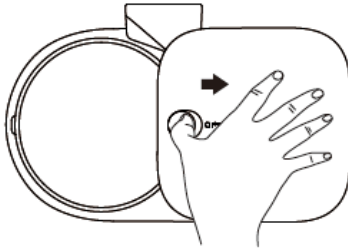

3.3 Install the backup batteries

- ① Take out the screw and remove the battery cover.
- ② Take 5 AAA batteries and place them in the battery compartment. (Pay attention to the orientation of the positive and negative ends)
- ③ Put the battery cover back on and tighten down the screw.

Choose whether to install batteries based on personal actual usage needs. (Batteries need to be purchased separately, and only alkaline batteries can be used)

*** Note: When the battery is low, please replace the batteries in time. Check and replace the batteries before leaving the device unattended for an extended period of time.**

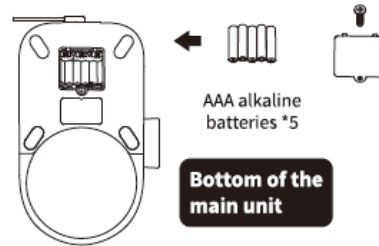

② Open the desiccant compartment, take the desiccant packet, and lay it down evenly in the compartment, Then close the desiccant compartment.

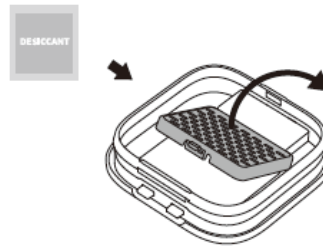

04 HOW TO USE

4.1 Add pet food

① Open the lid to add pet food, do not exceed the MAX line.

* Suggest to use dry food dimensions ≤ 12mm/0.47in
Suggest to use freeze-dried food diameters ≤ 9mm/0.35in

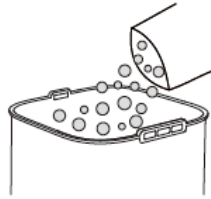

② Cover the lid: Insert the rear side of the lid into the two holes above the food storage container.

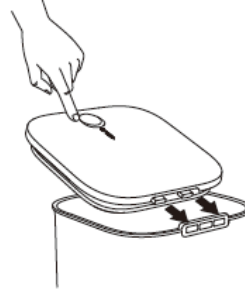

4.2 Indicator light

The indicator light can be turned on/off in the app.
When using the batteries, the indicator light will be turned off.

Indicator light	Status
White light is flashing slowly	Device is offline, there is no internet connection
White light is flashing quickly	Device is connecting to the Wi-Fi
White light is constantly on	Device is connected to Wi-Fi (Camera is not working)
Green light is constantly on	Device is connected to Wi-Fi (Camera is working)

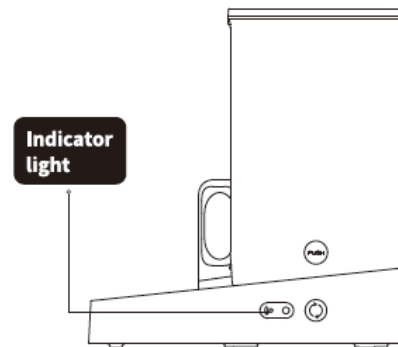

4.3 Manual feeding

Hold the manual food dispense button to dispense food. Release the button to stop dispensing food.

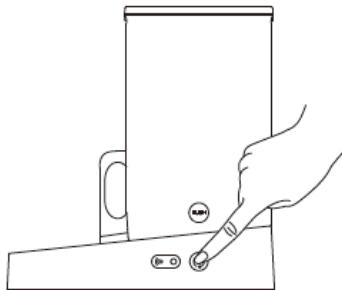

4.4 App smart control

App Download and installation: Download PETKIT App from the App Store or Google Play. Enter the homepage, click "+" to add the corresponding device, and bind the device according to the guides.



Scan the QR code to download PETKIT App

- ① Feeding plans can be set in the app, and the feeder will automatically dispense food at set time every day according to the plan. You will receive prompt messages and timely notice the food dispense and feeding status.
- ② The app support real-time viewing of monitor and voice interaction. At the same time, you can also share and review the monitor images. (More exciting features can be experienced in the app)

05 CLEANING AND MAINTENANCE

① Open the lid to remove the desiccant, and then remove the food bowl.

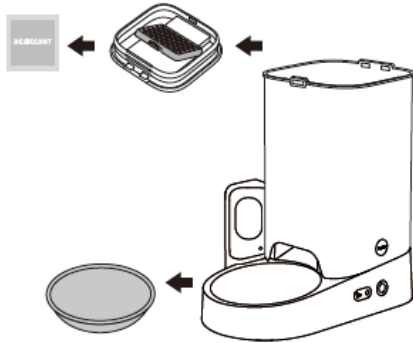

② Hold the PUSH buttons on both sides of the main unit with middle fingers, and lift it up at the same time to remove the food storage container.

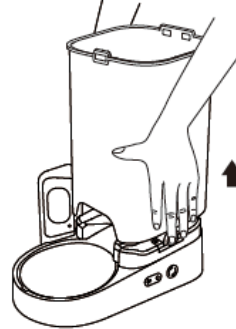

③ Pull out the food dispense paddles in the food storage container. Rotate clockwise to remove the Impeller cover and take out the impeller.

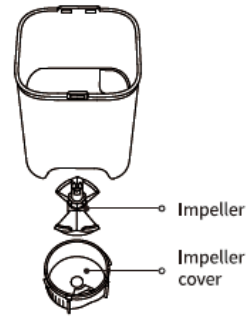
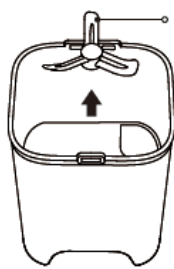

④ Clean the food storage container, paddles, impeller cover, impeller, upper lid and food bowl in turn. It is recommended to add appropriate amount of detergent and rinse well.

⑤ After cleaning, wait for each part to dry completely and install them back in turn.

*Please refer to the maintenance & cleaning video for detailed steps (see the QR code below)



Please be sure to use a sponge or soft cloth to clean the inside of the food storage container, do not use hard-material cleaning tools to avoid scratching the plastic parts and affecting the normal operation of the sensor. Main unit cannot be immersed or soaked in water, it can be wiped with a damp tissue.

06 VIDEO GUIDE

6.1 Installation & Usage Video



Scan QR code to watch

6.2 Maintenance & Cleaning Video



Scan QR code to watch

| BASIC SPECIFICATIONS

Product Name	PETKIT YUMSHARE SOLO WITH CAMERA SMART PET FEEDER
Product Code	P571
Product Dimensions	316*186*296mm (12.4*7.3*11.7in)
Container Capacity	3L
Overall Weight	about 1.7kg (3.7lb)
Rated Input	6V \blacksquare 2A
Rated Power	4W
Wireless Connection	Wi-Fi
Scope of Application	cats and small breed dogs

| A MESSAGE TO OUR VALUED CUSTOMERS

- Thank you for choosing to purchase PETKIT YUMSHARE SOLO WITH CAMERA SMART PET FEEDER
- Please carefully read the User Manual before using the product. By setting up and using this product, you are acknowledged that you have already read and accepted the safety guidelines listed below.
- We are not liable and will not accept responsibility for any accidents or injuries that result from improper use of this product.
- PETKIT reserves the rights of interpretation and revision.

| USER SAFETY GUIDE

*** Failure to follow the safety guides outlined below can result in product malfunction or other unforeseen mishaps.**

- Please install and use the product as instructed in the User Manual.
- Do not try to disassemble the camera with force.
- Do not scratch or polish the camera with sharp objects.
- For indoor use only. Do not expose the product directly to sunlight for extended periods of time. Do not place it near an open flame.
- The device is using low voltages. However, pets can still cause electrical leakage if they chew on power cord. Please guide your pets use the product properly.
- Please use the original adapter, otherwise it may damage the device or cause safety hazards.
- Make sure the device is placed on a level surface. Do not overturn the device, or it may not function properly.
- Do not drop all items expect dry pet food into the food storage container, or the device will not function properly, and it may even endanger the safety of the pet.
- In order to prevent your pet from overturning this device, we recommend placing it in a corner or against a wall.
- To prevent the device from falling down and injuring your pet or damaging property, please do not place this device in an elevated location.
- The main unit of the product is prohibited from soaking or submerging in water, and the machine should not be used in damp environments.
- If you want to stop using the device, make sure to remove the battery and unplug the power adapter, and please clean and dry the device before storing.
- Please unplug the power cord before moving the device.
- Children should use this product under the guidance of adults.
- Repairs should be done under the guidance of a professional to avoid safety hazards.
- If you need to go out, please check the battery in the battery compartment to make sure the battery has sufficient charge (this device can only use alkaline batteries).

Disposal

The European directive 2012 / 19 / CE on Waste Electrical and Electronic Equipment(WEEE), requires that old household electrical appliances must not be disposed in the normal unsorted municipal waste stream. Old appliances must be collected separately in order to optimize the recovery and recycling of the materials they contain and reduce the impact on human health and the environment. The crossed out "wheeled bin" symbol on the product reminds you of your obligation, that when you dispose of the appliance it must be separately collected. Consumers should contact their local authority or retailer for information concerning the correct disposal of their old appliance.

This device complies with part 15 of the FCC Rules. Operation is subject to the following two conditions:

- (1) This device may not cause harmful interference, and
- (2) this device must accept any interference received, including interference that may cause undesired operation.

FCC warning:

Any changes or modifications not expressly approved by the party responsible for compliance could void the user's authority to operate the equipment. Note: This equipment has been tested and found to comply with the limits for a Class B digital device, pursuant to part 15 of the FCC Rules. These limits are designed to provide reasonable protection against harmful interference in a residential installation. This equipment generates uses and can radiate radio frequency energy and, if not installed and used in accordance with the instructions, may cause harmful interference to radio communications. However, there is no guarantee that interference will not occur in a particular installation. If this equipment does cause harmful interference to radio or television reception, which can be determined by turning the equipment off and on, the user is encouraged to try to correct the interference by one or more of the following measures:

- Reorient or relocate the receiving antenna.
- Increase the separation between the equipment and receiver.
- Connect the equipment into an outlet on a circuit different from that to which the receiver is connected.
- Consult the dealer or an experienced radio/TV technician for help.

The device has been evaluated to meet general RF exposure requirement.

This equipment complies with FCC radiation exposure limits set forth for an uncontrolled environment. The antenna(s) used for this equipment must be installed and used in a separation distance of at least 20 cm from all persons.

IC warning

- English:

This device complies with Industry Canada licence-exempt RSS standard(s). Operation is subject to the following two conditions:

- (1) This device may not cause interference, and
- (2) this device must accept any interference, including interference that may cause undesired operation of the device.

- French:

Le présent appareil est conforme aux CNR d'Industrie Canada applicables aux appareils radio exempts de licence. L'exploitation est autorisée aux deux conditions suivantes:

- (1) l'appareil ne doit pas produire de brouillage, et
- (2) l'utilisateur de l'appareil doit accepter tout brouillage radioélectrique subi, même si le brouillage est susceptible d'en compromettre le fonctionnement.