

PETKIT™

USER MANUAL

PETKIT EVERSWEET MAX (CORDLESS)

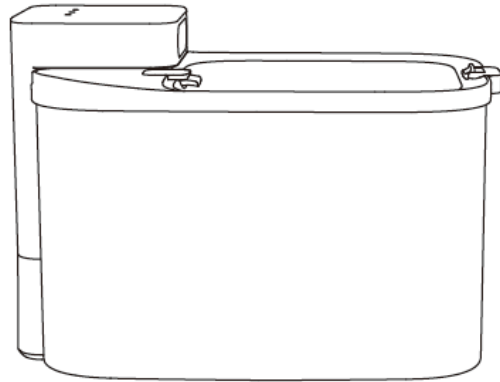

Please read the User Manual carefully before using the product and keep it properly.

TABLE OF CONTENTS

PRODUCT LIST -----	3
PRODUCT DESCRIPTION -----	4,5
PRODUCT INSTALLATION -----	6,7,8
HOW TO USE -----	8,9,10
CLEANING AND MAINTENANCE -----	11
VIDEO GUIDE -----	12
BASIC SPECIFICATIONS -----	10
A MESSAGE TO OUR VALUED CUSTOMERS -----	13
USER SAFETY GUIDE -----	13

01 PRODUCT LIST

* Before use, please take out all accessories from the water tank, and check whether the accessories are complete according to the following list, then rinse the water tank, lid, outlet pipe, stainless steel water tray, wireless pump, and filter holder.

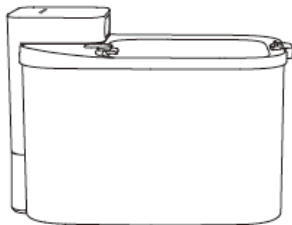

Main Unit



Outlet Pipe



Filter

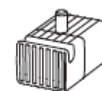

Wireless Water Pump^①



2 in 1
Cleaning Brush



Power Cord



User Manual

Note:

① The water pump works continuously in normal mode. The service life of the water pump may vary depending on different usage and maintenance. Replace the water pump with a new one if necessary.

* Note: In order to enhance the user experience, periodic product improvements may be implemented. The product images shown are for illustrative purposes only. The actual product may vary from the image displayed on the packaging. For any inconsistencies, please refer to the actual product.

02 PRODUCT DESCRIPTION

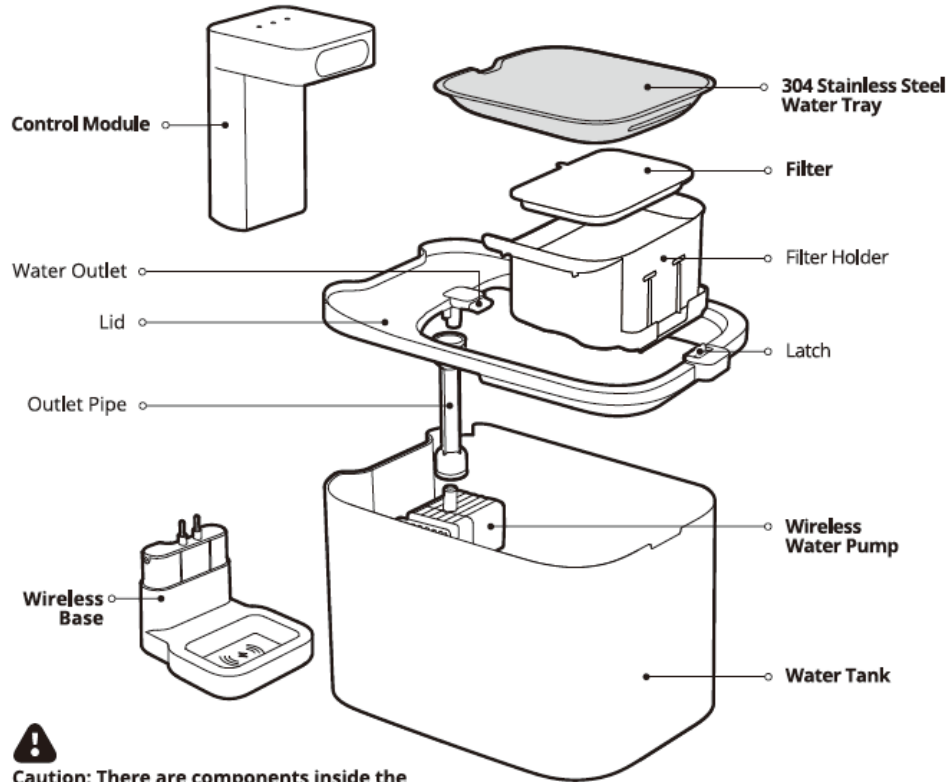

Caution: There are components inside the wireless base and control module. Do not rinse or soak them.

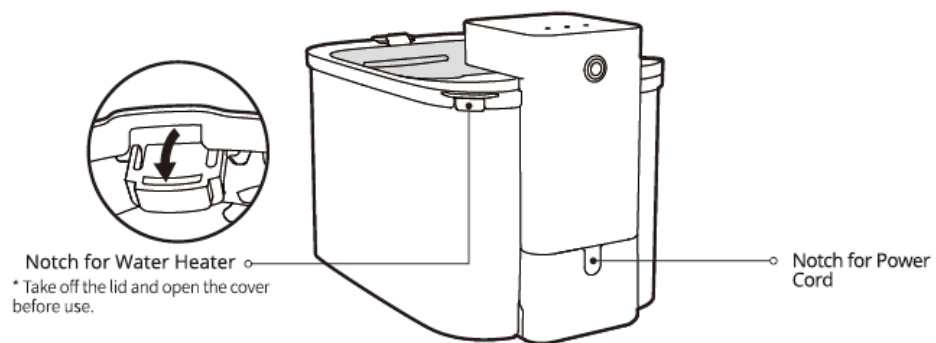
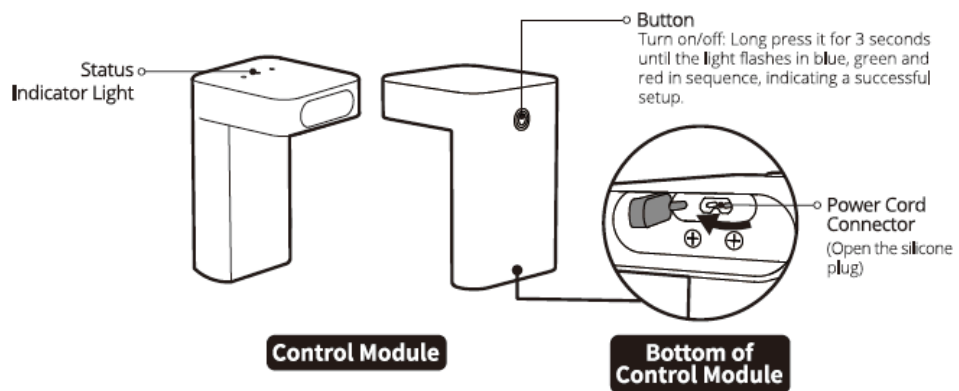

03 PRODUCT INSTALLATION

① Take out the control module vertically upwards.



② Unlock the latch and take out the stainless steel water tray.

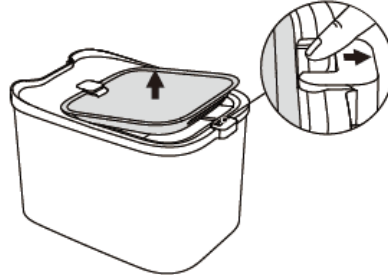

③ Take out the lid and filter holder.



④ Put the water pump into the groove in the water tank, and then insert the outlet pipe into the water outlet above the wireless water pump.

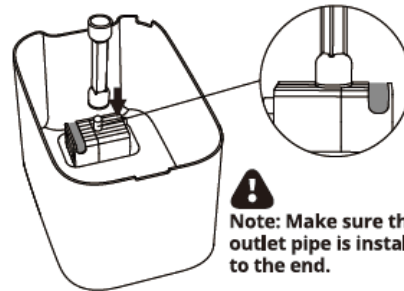

Note: Make sure the outlet pipe is installed to the end.

⑤ Put the lid, place filter holder as shown in the picture, and put the filter in its holder.
(* Before using the filter, please read the instructions on the filter package carefully.)

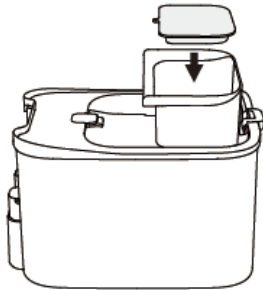

⑥ Add water to the water tank up to the position of the MAX line.



⑦ Insert point A of the water tray under the outlet, and pull the latch outward to secure the other side of the water tray.

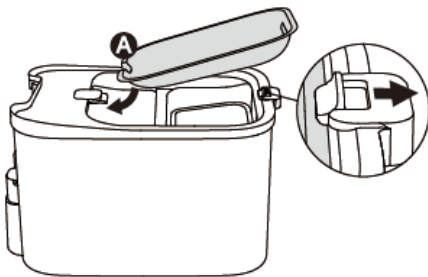

⑧ Insert the control module vertically into the base, and the installation is complete.



04 HOW TO USE

4.1 Usage Modes

* This product offers two power supply options, and you can choose according to your needs.

4.1.1 Plug it in

① Remove the control module, open the silicone plug, and insert the power cord into the power input at the bottom of the control module.

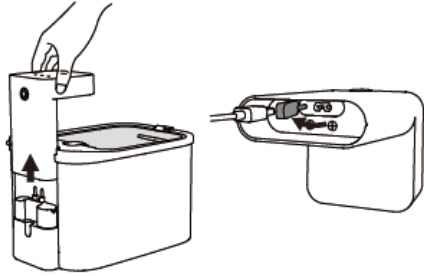

② Vertically insert the control module back to its base and plug in.

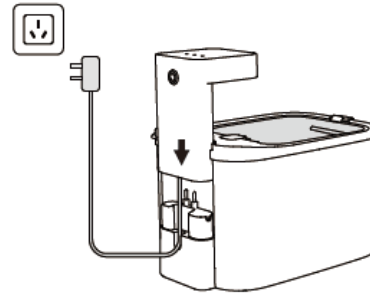

③ Press the button to switch water dispensing modes.

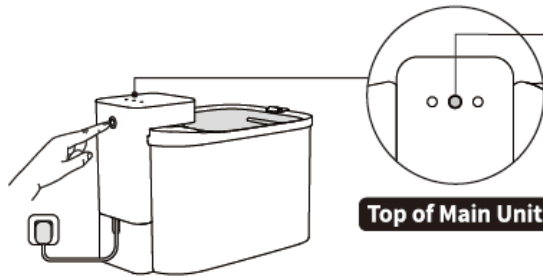

Status indicator light

① Normal Mode

Solid blue: Continuous flow

② Intermittent Mode

Solid green: Intermittent flow
(Customize water dispensing frequency in the App. The default setting is to dispense water for 3 minutes and stop for 3 minutes.)

4.1.2 Unplug (powered by built-in battery)

① Remove the control module, and plug the power cord into its connector to charge the control module.

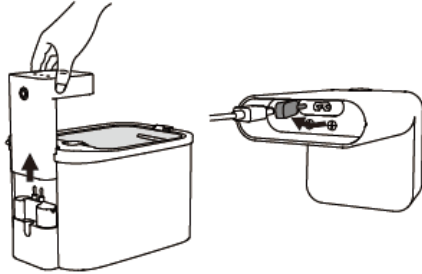

② The solid blue or green light indicates full charging. Unplug it, cover the silicone plug, and insert the control module into the base vertically.

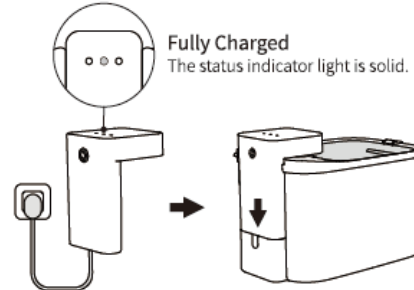

③ Switching water dispensing mode is not available in battery mode.

(To preserve the battery's service life, the water is pumped for 25 seconds per hour by default.)

* Water dispense frequency can be set by clicking "Energy management" in the PETKIT App. Please note that high frequency of pumping water will shorten the battery life. To provide you with the best possible user experience, unscheduled optimization will be performed on software and its functions. Please refer to the real features in the App.

④ The case that the status indicator light flashes in red shows low battery power. Please plug in to charge the control module.

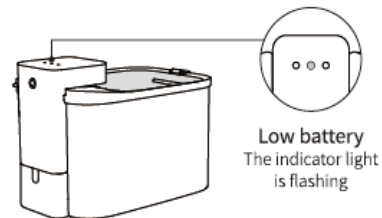

4.2 Indicator Description

Filter Indicator^① Water Shortage Indicator^②

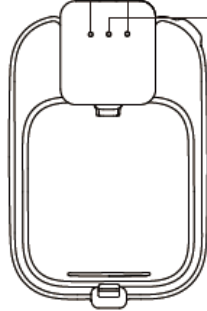

Top view of the device

Plug in

Fully charged: Solid blue or green

Charging: Flashing blue or green

* The light color depends on the water dispensing mode.

Unplug

The green light is on for 15 seconds and then goes off. (In this way, the working time is extended.)

Low battery: Flashing red

Main Unit Failure

The light flashes blue and green alternately.

① Flashing red means that the filter needs to be replaced. Please reset in the App after replacement, then the indicator will go off. (Water fountain in normal operation)

② Flashing red means water shortage. The indicator will go off after refilling water. (Water fountain in normal operation)

*** When the control module is removed, indicator lights of filter and water shortage are solid red. When the control module is reassembled, the two lights will go off.**

4.3 App Control

Download and install the App: Download "PETKIT" from App Store or Android Stores.

Enter the App "Home Page", click "+" to add the device, and bind the device according to the prompts.



Scan the QR code to download PETKIT App to experience more functions.

In the App, you can set different water flow modes and track your pet's water intake. (More functions can be viewed in the App.)

05 CLEANING AND MAINTENANCE

The cleaning frequency is based on pet's habits and water quality. To ensure healthy drinking water for pets, it is recommended to clean the water tank at least once a week and clean thoroughly once a month. (View 06 for the video about cleaning and maintenance)

① Remove the control module and the wireless base, and wipe them with a dry cloth or slightly damp cloth. Please do not immerse them in water.

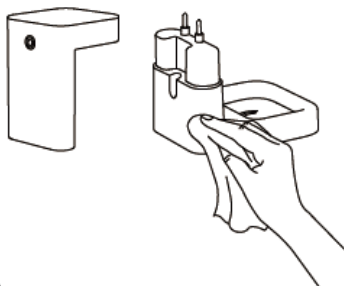

Caution: There are components inside the wireless base and control module. Do not rinse or soak them.

② Clean the lid, water tray, filter holder, water tank, outlet pipe, and wireless water pump.



06 VIDEO GUIDE

6.1 Installation & Usage Video



Scan QR code to watch

6.2 Maintenance & Cleaning Video



Scan QR code to watch

| BASIC SPECIFICATIONS

Name	PETKIT EVERSWEET MAX (CORDLESS)	Weight	About 1.2kg (2.6lb)
Model	P4115	Rated Input	5V = 1A
Material	ABS, 304 Stainless Steel	Rated Power	2W
Dimensions	265*171*191mm (10.4*6.7*7.5in)	Connection	Bluetooth
Capacity	3L (101oz)	Scope of Application	Cats and small-breed dogs

| A MESSAGE TO OUR VALUED CUSTOMERS

- Thank you for choosing the PETKIT EVERSWEET MAX (CORDLESS).
- It is important to read and follow the User Manual before using the product. Once installed or used, it means that you have carefully read and accepted the following safety instructions.
- PETKIT is not liable for any accidents or injuries resulting from improper use of the product.
- PETKIT reserves the rights of interpretation and revision.

| USER SAFETY GUIDE

* Failure to follow the safety guides outlined below can result in product malfunction or other unforeseen mishaps.

- Please install and use the product as instructed in the User Manual.
- Pets under three months of age are not recommended to use this product.
- The product is for indoor use only. Avoid direct sunlight exposure and keep it away from open flames.
- Use only the original adapter to avoid device damage or safety hazards.
- Place the device on a level surface. Do not knock over the device, otherwise it will not work properly or spill water.
- Do not rinse or soak the base and the control module.
- Avoid damage to the pump during daily cleaning and maintenance. The case that you drop it accidentally may cause the internal ceramic shaft to break, resulting in product damage.
- Please note that this product operates on safe low voltage, but pets chewing on the wires may still pose a risk of electrical leakage. We recommend taking measures to prevent this, such as securing and hiding the power cord when using the product. If you find your pets chewing the cord, please stop them promptly.
- Please handle it with care, otherwise it may cause damage to the product.
- If you are not using or moving the product for an extended period, it is recommended to unplug the power cord.
- Children should use this product under the supervision and guidance of adults.
- Repairs should only be performed by professionals to avoid safety hazards.
- Before leaving for an extended period, ensure that there is sufficient water in the water tank.
- If you encounter any issues with the product, please contact our customer service for assistance.

This device complies with part 15 of the FCC Rules. Operation is subject to the following two conditions:

(1) This device may not cause harmful interference, and ; (2) this device must accept any interference received, including interference that may cause undesired operation.

FCC warning:

Any Changes or modifications not expressly approved by the party responsible for compliance could void the user's authority to operate the equipment.

Note: This equipment has been tested and found to comply with the limits for a Class B digital device, pursuant to part 15 of the FCC Rules.

These limits are designed to provide reasonable protection against harmful interference in a residential installation. This equipment generates uses and can radiate radio frequency energy and, if not installed and used in accordance with the instructions, may cause harmful interference to radio communications. However, there is no guarantee that interference will not occur in a particular installation. If this equipment does cause harmful interference to radio or television reception, which can be determined by turning the equipment off and on, the user is encouraged to try to correct the interference by one or more of the following measures:

-Reorient or relocate the receiving antenna.

-Increase the separation between the equipment and receiver.

-Connect the equipment into an outlet on a circuit different from that to which the receiver is connected.

-Consult the dealer or an experienced radio/TV technician for help.

The device has been evaluated to meet general RF exposure requirement.

This equipment complies with FCC radiation exposure limits set forth for an uncontrolled environment. This equipment should be installed and operated with minimum distance 20cm between the radiator & your body.

IC warning

- English:

This device complies with Industry Canada licence-exempt RSS standard(s). Operation is subject to the following two conditions:

(1) This device may not cause interference, and

(2) This device must accept any interference, including interference that may cause undesired operation of the device.

- French:

Le présent appareil est conforme aux CNR d'Industrie Canada applicables aux appareils radio exempts de licence.

L'exploitation est autorisée aux deux conditions suivantes:

(1) l'appareil ne doit pas produire de brouillage, et

(2) l'utilisateur de l'appareil doit accepter tout brouillage radioélectrique subi, même si le brouillage est susceptible d' compromettre le fonctionnement.

Disposal

The European directive 2012 / 19 / CE on Waste Electrical and Electronic Equipment(WEEE), requires that old household electrical appliances must not be disposed in the normal unsorted municipal waste stream. Old appliances must be collected separately in order to optimize the recovery and recycling of the materials they contain and reduce the impact on human health and the environment. The crossed out "wheeled bin" symbol on the product reminds you of your obligation, that when you dispose of the appliance it must be separately collected. Consumers should contact their local authority or retailer for information concerning the correct disposal of their old appliance.