

Test Report

Product: Anti-Lost Wireless Powerbank

Trade Mark: Wisdene

Model Number: PB002M

FCC ID: 2A6W7-PB002M

Prepared for

Shenzhen XinNengDa Technology Co., Ltd
301, Building A4, No. 11, Tianyang 4th Road, Dongfang Community,
Songgang Street, Bao'an District, Shenzhen, Guangdong, China

Prepared by

Shenzhen HongBiao Certification& Testing Co., Ltd
Room 102, 201, Building 2, Yuanwanggu RFID Industrial Park, Tongguan
Road, Tianliao Community, Yutang Street, Guangming District, Shenzhen,
China

Tel.: +86-755-2998 9321 Fax.: +86-755-2998 5110

Website: <http://www.sz-hongbiao.com>

Table of Contents

| | | |
|----------|--|-----------|
| 1 | GENERAL DESCRIPTION | 6 |
| 1.1 | DESCRIPTION OF EUT | 6 |
| 1.2 | TEST MODE..... | 6 |
| 1.3 | OPERATION CHANNEL LIST..... | 6 |
| 1.4 | TEST SETUP | 7 |
| 1.5 | ANCILLARY EQUIPMENT | 7 |
| 2 | SUMMARY OF TEST RESULT | 8 |
| 3 | TEST FACILITIES AND ACCREDITATIONS | 9 |
| 3.1 | TEST LABORATORY | 9 |
| 3.2 | ENVIRONMENTAL CONDITIONS..... | 9 |
| 3.3 | MEASUREMENT UNCERTAINTY | 9 |
| 3.4 | TEST SOFTWARE..... | 9 |
| 4 | LIST OF TEST EQUIPMENT | 10 |
| 5 | TEST ITEM AND RESULTS..... | 12 |
| 5.1 | ANTENNA REQUIREMENT..... | 12 |
| 5.1.1 | <i>Standard Requirement</i> | 12 |
| 5.1.2 | <i>Test Result</i> | 12 |
| 5.2 | CONDUCTED EMISSION..... | 13 |
| 5.2.1 | <i>Limits</i> | 13 |
| 5.2.2 | <i>Test Procedures</i> | 13 |
| 5.2.3 | <i>Test Setup</i> | 14 |
| 5.2.4 | <i>Test Result</i> | 14 |
| 5.3 | RADIATED EMISSION | 17 |
| 5.3.1 | <i>Limits</i> | 17 |
| 5.3.2 | <i>Test Procedures</i> | 17 |
| 5.3.3 | <i>Test Setup</i> | 17 |
| 5.3.4 | <i>Test Result</i> | 18 |
| 5.3.5 | <i>Band Edge - Radiated</i> | 22 |
| 5.3.6 | <i>Spurious emission in restricted band 1GHz-25GHz</i> | 23 |
| 5.4 | PEAK OUTPUT POWER | 24 |
| 5.4.1 | <i>Limit</i> | 24 |
| 5.4.2 | <i>Test Procedure</i> | 24 |
| 5.4.3 | <i>Test Setup</i> | 24 |
| 5.4.4 | <i>Test Results</i> | 24 |
| 5.5 | POWER SPECTRAL DENSITY..... | 27 |
| 5.5.1 | <i>Limit</i> | 27 |
| 5.5.2 | <i>Test Procedure</i> | 27 |
| 5.5.3 | <i>Test Setup</i> | 27 |
| 5.5.4 | <i>Test Results</i> | 27 |
| 5.6 | 6dB BANDWIDTH..... | 30 |
| 5.6.1 | <i>Limit</i> | 30 |
| 5.6.2 | <i>Test Procedure</i> | 30 |
| 5.6.3 | <i>Test Setup</i> | 30 |
| 5.6.4 | <i>Test Results</i> | 30 |
| 5.7 | DUTY CYCLE | 33 |
| 5.7.1 | <i>Limit</i> | 33 |
| 5.7.2 | <i>Test Procedure</i> | 33 |
| 5.7.3 | <i>Test Setup</i> | 33 |
| 5.7.4 | <i>Test Results</i> | 33 |
| 5.8 | CONDUCTED BAND EDGE..... | 37 |
| 5.8.1 | <i>Limit</i> | 37 |

| | | |
|-------|---------------------------------------|----|
| 5.8.2 | <i>Test Procedure</i> | 37 |
| 5.8.3 | <i>Test Setup</i> | 37 |
| 5.8.4 | <i>Test Results</i> | 37 |
| 5.9 | SPURIOUS RF CONDUCTED EMISSIONS | 40 |
| 5.9.1 | <i>Limit</i> | 40 |
| 5.9.2 | <i>Measuring Instruments</i> | 40 |
| 5.9.3 | <i>Test Procedure</i> | 40 |
| 5.9.4 | <i>Test Setup</i> | 40 |
| 5.9.5 | <i>Test Results</i> | 40 |
| 6 | PHOTOGRAPHS OF THE TEST SETUP..... | 43 |
| 7 | PHOTOGRAPHS OF THE EUT..... | 45 |

TEST RESULT CERTIFICATION

Applicant's Name..... : Shenzhen XinNengDa Technology Co.,Ltd
301, Building A4, No. 11, Tianyang 4th Road, Dongfang
Address : Community, Songgang Street, Bao'an District, Shenzhen,
Guangdong, China
Manufacturer's Name : Shenzhen XinNengDa Technology Co.,Ltd
301, Building A4, No. 11, Tianyang 4th Road, Dongfang
Address : Community, Songgang Street, Bao'an District, Shenzhen,
Guangdong, China

Product description

Product name : Anti-Lost Wireless Powerbank
Model Number : PB002M
Standards : FCC Part 15.247
IEEE/ANSI C63.10-2020
Test procedure..... : KDB558074 D01 15.247 Meas Guidance v05r02

This device described above has been tested by Shenzhen HongBiao Certification& Testing Co., Ltd and the test results show that the equipment under test (EUT) is in compliance with the EMC requirements. And it is applicable only to the tested sample identified in the report.

Date of Test

Date (s) of performance of tests..... : Apr. 17, 2024~Apr. 30, 2024
Test Result..... : **Pass**

Testing Engineer : Zoe Su
(Z o e S u)

Technical Manager : Gary Lu
(G a r y L u)

Authorized Signatory : Leo Su
(L e o S u)

1 General Description

1.1 Description of EUT

| | |
|----------------------------|--|
| Product name: | Anti-Lost Wireless Powerbank |
| Model name: | PB002M |
| Series Model: | AVNU-AT08 |
| Different of series model: | All the models are the same circuit and module, except the model No.. |
| Operation frequency: | 2402-2480MHz |
| Modulation type: | GFSK |
| Bit Rate of transmitter: | 1 Mbps, 2 Mbps |
| Antenna type: | FPCB Antenna |
| Antenna gain: | 1.08dBi |
| Max. output power: | 0.3dBm |
| Hardware version: | V1.0 |
| Software version: | V1.0 |
| Battery: | DC 3.87V, 4400mAh, 17.415Wh |
| Power supply: | USB-C Input/Output: DC 5V/3A, 9V/2.4A, 12V/1.75A Wireless Output: 5W/7.5W/10W/15W |
| Adapter information: | N/A |

1.2 Test Mode

| Test Mode | Channel | Frequency (MHz) |
|-----------|---------|-----------------|
| BLE 1M | 00 | 2402 |
| BLE 1M | 19 | 2440 |
| BLE 1M | 39 | 2480 |
| BLE 2M | 00 | 2402 |
| BLE 2M | 19 | 2440 |
| BLE 2M | 39 | 2480 |

1.3 Operation Channel list

| Channel No. | Frequency (MHz) | Channel No. | Frequency (MHz) | Channel No. | Frequency (MHz) | Channel No. | Frequency (MHz) |
|-------------|-----------------|-------------|-----------------|-------------|-----------------|-------------|-----------------|
| 0 | 2402 | 10 | 2422 | 20 | 2442 | 30 | 2462 |

| | | | | | | | |
|---|------|----|------|----|------|----|------|
| 1 | 2404 | 11 | 2424 | 21 | 2444 | 31 | 2464 |
| 2 | 2406 | 12 | 2426 | 22 | 2446 | 32 | 2466 |
| 3 | 2408 | 13 | 2428 | 23 | 2448 | 33 | 2468 |
| 4 | 2410 | 14 | 2430 | 24 | 2450 | 34 | 2470 |
| 5 | 2412 | 15 | 2432 | 25 | 2452 | 35 | 2472 |
| 6 | 2414 | 16 | 2434 | 26 | 2454 | 36 | 2474 |
| 7 | 2416 | 17 | 2436 | 27 | 2456 | 37 | 2476 |
| 8 | 2418 | 18 | 2438 | 28 | 2458 | 38 | 2478 |
| 9 | 2420 | 19 | 2440 | 29 | 2460 | 39 | 2480 |

1.4 Test Setup

See photographs of the test setup in the report for the actual setup and connections between EUT and support equipment.

1.5 Ancillary Equipment

| Equipment | Model | S/N | Manufacturer |
|-----------|--------------|--------------------|-----------------------|
| Adapter | HN-200325CP0 | JG06LEN2T0 4802 | Huawei Honor Co., LTD |
| Laptop | / | / | Lenovo |
| | | | |
| | | | |
| | | | |

2 Summary of Test Result

| No. | Standard Section | Test Item | Result | Remark |
|-----|--|------------------------------------|--------|--------|
| 1 | 15.203 | Antenna Requirement | Pass | |
| 2 | 15.247 (b) | Peak Output Power | Pass | |
| 3 | 15.207 | Conducted Emission | Pass | |
| 4 | 15.247 (d) & 15.209 | Radiated Spurious Emission | Pass | |
| 5 | 15.247 (e) | Power Spectral Density | Pass | |
| 6 | 15.247 (a)(2) | 6dB Bandwidth | Pass | |
| 7 | 558074 D01 15.247 Meas Guidance v05r02 Chapter 6 | Duty Cycle | Pass | |
| 8 | 15.205 | Band Edge Emission | Pass | |
| 9 | 15.247(d) | Spurious RF Conducted Emissions | Pass | |

3 Test Facilities and Accreditations

3.1 Test Laboratory

| | |
|-----------------------|---|
| Test Site | Shenzhen HongBiao Certification & Testing Co., Ltd |
| Test Site Location | Room 102, 201, Building 2, Yuanwanggu RFID Industrial Park, Tongguan Road, Tianliao Community, Yutang Street, Guangming District, Shenzhen, China |
| Telephone: | (86-755) 2998 9321 |
| Fax: | (86-755) 2998 5110 |
| FCC Registration No.: | CN1341 |
| A2LA Certificate No.: | 6765.01 |

3.2 Environmental Conditions

During the measurement the environmental conditions were within the listed ranges:

| | |
|--------------------|--------------|
| Temperature: | 15°C~35°C |
| Relative Humidity: | 20%~75% |
| Air Pressure: | 98kPa~101kPa |

3.3 Measurement Uncertainty

The reported uncertainty of measurement $y \pm U$, where expanded uncertainty U is based on a standard uncertainty multiplied by a coverage factor of $k=2$, providing a level of confidence of approximately 95 %.

| Measurement Frequency Range | U, (dB) | Note |
|----------------------------------|--------------------|------|
| RF frequency | 2×10^{-5} | |
| RF power, conducted | ± 0.57 dB | |
| Conducted emission(150kHz~30MHz) | ± 2.5 dB | |
| Radiated emission(9kHz-30MHz) | ± 2.5 dB | |
| Radiated emission(30MHz~1GHz) | ± 4.2 dB | |
| Radiated emission (above 1GHz) | ± 4.7 dB | |
| Occupied Bandwidth | $\pm 3\%$ | |
| Temperature | ± 1 degree | |
| Humidity | $\pm 5 \%$ | |

3.4 Test Software

| Software name | Manufacturer | Model | Version |
|-----------------------|--------------|----------|----------|
| EMI Measurement | Farad | EZ-EMC | V1.1.4.2 |
| Conducted test system | MWRF-test | MTS 8310 | V2.0.0 |

4 List of Test Equipment

| Radiation emission | | | | | | | |
|---------------------|---------------|--|--------------|-------------|--------------|------------------|------------|
| Item | Equipment No. | Equipment name | Manufacturer | Model | Serial No. | Calibration date | Due date |
| 1 | HB-E001 | Horn Antenna | Schwarzbeck | BBHA 9120D | 02592 | 2024-04-02 | 2026-04-01 |
| 2 | HB-E002 | Biconical log-periodic composite antenna | Schwarzbeck | VULB 9168 | 01340 | 2024-04-06 | 2026-04-05 |
| 3 | HB-E003 | SHF-EHF Horn | Schwarzbeck | BBHA 91270 | 01193 | 2022-04-02 | 2024-04-01 |
| 4 | HB-E004 | Preamplifier | Noyetec | LAN-0910 | NYCM1420101 | 2023-05-11 | 2024-05-10 |
| 5 | HB-E005 | Preamplifier | Noyetec | LAN-0118 | NYCM1420102 | 2023-05-12 | 2024-05-11 |
| 6 | HB-E006 | Preamplifier | Noyetec | LAN-1840 | NYCM1420103 | 2023-06-11 | 2024-06-10 |
| 7 | HB-E007 | EMI TEST RECEIVER | R&S | ESR7 | 102520 | 2023-05-12 | 2024-05-11 |
| 8 | HB-E009 | POSITINAL COTROLLER | Noyetec | N/A | N/A | / | / |
| 9 | HB-E013 | RF switch | Noyetec | NY-RF4 | NY0CM1420204 | / | / |
| 10 | HB-E066 | Illuminance Tester | TASI | TA8121 | N/A | 2023-05-11 | 2024-05-10 |
| 11 | HB-E075 | Active loop antenna | Schwarzbeck | FMZB 1519B | 1519B-245 | 2022-07-24 | 2024-07-23 |
| Conduction emission | | | | | | | |
| Item | Equipment No. | Equipment name | Manufacturer | Model | Serial No. | Calibration date | Due date |
| 1 | HB-E014 | 4 Path V-LISN | Schwarzbeck | NNLK 8121 | 00770 | 2023-05-12 | 2024-05-11 |
| 2 | HB-E015 | Pulse Limiter | Schwarzbeck | VTSD 9561-F | 00949 | 2023-05-12 | 2024-05-11 |
| 3 | HB-E016 | ZN23201 | Noyetec | ZN23201 | N/A | 2023-05-11 | 2024-05-10 |
| 4 | HB-E059 | Attenuator | Xianghua | TS2-6-1 | 220215166 | 2023-05-12 | 2024-05-11 |
| 5 | HB-E069 | EMI TEST RECEIVER | R&S | ESCI | N/A | 2023-05-12 | 2024-05-11 |
| RF | | | | | | | |
| Item | Equipment No. | Equipment name | Manufacturer | Model | Serial No. | Calibration date | Due date |
| 1 | HB-E041 | MXG Anaio Signal Generator | Agilent | N5181A | MY47070421 | 2023-05-11 | 2024-05-10 |
| 2 | HB-E042 | WIDEBAND RADIO COMMUNICA | R&S | CMW500 | 132108 | 2023-05-11 | 2024-05-10 |

| | | TION TESTER | | | | | |
|---|---------|--|---------|----------------|------------|------------|------------|
| 3 | HB-E043 | MXG Anaio Signal Generator | Agilent | N5182A | US46240335 | 2023-05-11 | 2024-05-10 |
| 4 | HB-E044 | Signal& spectrum Analyzer | R&S | FSV3044 | 101264 | 2023-05-11 | 2024-05-10 |
| 5 | HB-E045 | RF Control Box | Noyetec | NY100-R FCB | N/A | / | / |
| 6 | HB-E058 | Thermometer Clock Humidity Monitor | N/A | HTC-1 | N/A | / | / |

Note: the calibration interval of the above test instruments is 12&24 months and the calibrations are traceable to international system unit (SI).

5 Test Item And Results

5.1 Antenna Requirement

5.1.1 Standard Requirement

15.203 requirement: For intentional device, according to 15.203: an intentional radiator shall be designed to ensure that no antenna other than that furnished by the responsible party shall be used with the device

5.1.2 Test Result

The EUT antenna is FPCB Antenna. It comply with the standard requirement. In case of replacement of broken antenna the same antenna type must be used.

5.2 Conducted Emission

5.2.1 Limits

| Limits – Class B | | |
|------------------|--------------------|-----------|
| Frequency (MHz) | Limit (dB μ V) | |
| | Quasi-Peak | Average |
| 0.15 to 0.5 | 66 to 56* | 56 to 46* |
| 0.5 to 5 | 56 | 46 |
| 5 to 30 | 60 | 50 |

Note:

- the tighter limit applies at the band edges.
- the limit of "*" marked band means the limitation decreases linearly with the logarithm of the frequency in the range.

5.2.2 Test Procedures

a) EUT Operating Conditions

The EUT was configured for testing in a typical fashion (as a customer would normally use it). The EUT has been programmed to continuously transmit during test. This operating condition was tested and used to collect the included data.

b) The following table is the setting of the receiver

| Receiver Parameters | Setting |
|---------------------|----------|
| Attenuation | 10 dB |
| Start Frequency | 0.15 MHz |
| Stop Frequency | 30 MHz |
| IF Bandwidth | 9 kHz |

- The EUT was placed 0.8 meters from the horizontal ground plane with EUT being connected to the power mains through a line impedance stabilization network (LISN). All other support equipment powered from additional LISN(s). The LISN provide 50 Ohm/ 50uH of coupling impedance for the measuring instrument.
- Interconnecting cables that hang closer than 40 cm to the ground plane shall be folded back and forth in the center forming a bundle 30 to 40 cm long.
- I/O cables that are not connected to a peripheral shall be bundled in the center. The end of the cable may be terminated, if required, using the correct terminating impedance. The overall length shall not exceed 1 m.
- LISN is at least 80 cm from nearest part of EUT chassis.
- For the actual test configuration, please refer to the related Item – photographs of the test setup.

5.2.3 Test Setup

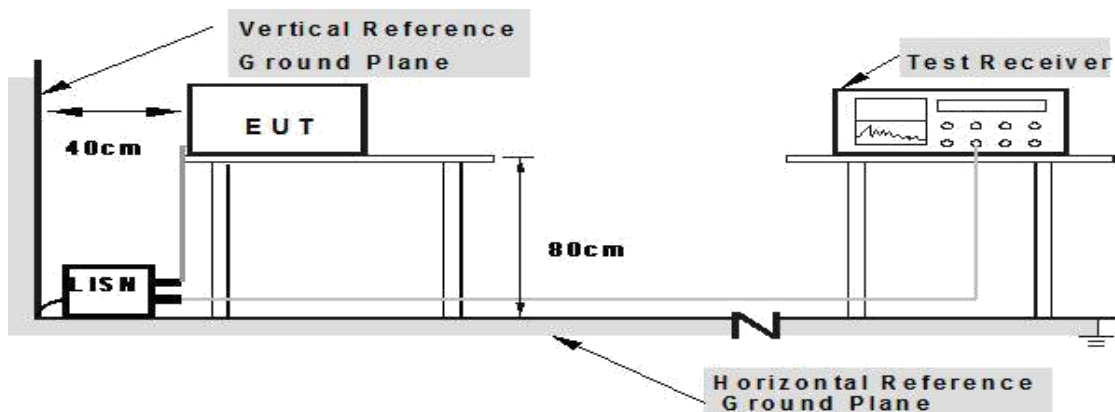

5.2.4 Test Result

| | | | |
|---------------|---------------------------------|-------------|--------|
| EUT: | Anti-Lost Wireless Powerbank | Model Name: | PB002M |
| Test Mode: | Charging+TX | Phase: | L |
| Test Voltage: | DC 5V from adapter AC 120V/60Hz | | |

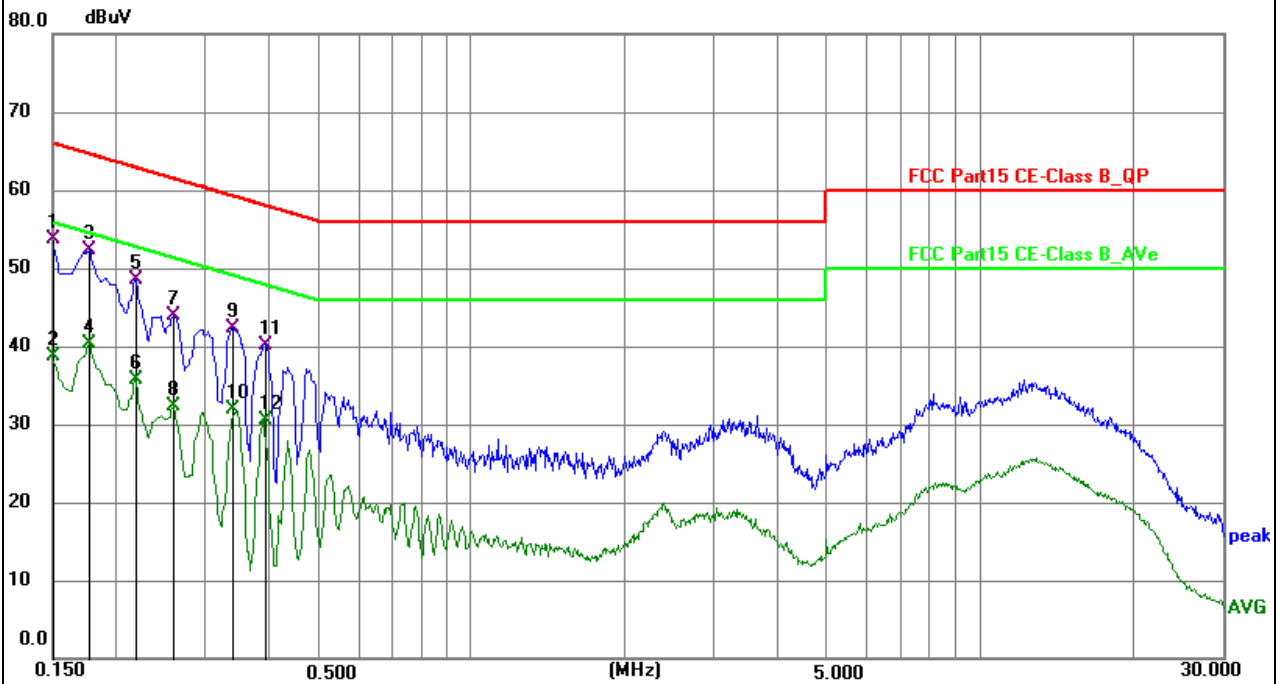

| No. | Frequency (MHz) | Reading (dBuV) | Factor (dB) | Level (dBuV) | Limit (dBuV) | Margin (dB) | Detector |
|-----|-----------------|----------------|-------------|--------------|--------------|-------------|----------|
| 1 * | 0.150000 | 43.62 | 10.15 | 53.77 | 66.00 | -12.23 | QP |
| 2 | 0.150000 | 28.55 | 10.15 | 38.70 | 56.00 | -17.30 | AVG |
| 3 | 0.176800 | 42.13 | 10.10 | 52.23 | 64.63 | -12.40 | QP |
| 4 | 0.176800 | 30.21 | 10.10 | 40.31 | 54.63 | -14.32 | AVG |
| 5 | 0.217400 | 38.47 | 10.07 | 48.54 | 62.92 | -14.38 | QP |
| 6 | 0.217400 | 25.64 | 10.07 | 35.71 | 52.92 | -17.21 | AVG |
| 7 | 0.258000 | 33.78 | 10.06 | 43.84 | 61.50 | -17.66 | QP |
| 8 | 0.258000 | 22.16 | 10.06 | 32.22 | 51.50 | -19.28 | AVG |
| 9 | 0.339000 | 32.23 | 10.09 | 42.32 | 59.23 | -16.91 | QP |
| 10 | 0.339000 | 21.86 | 10.09 | 31.95 | 49.23 | -17.28 | AVG |
| 11 | 0.393000 | 30.10 | 10.10 | 40.20 | 58.00 | -17.80 | QP |
| 12 | 0.393000 | 20.40 | 10.10 | 30.50 | 48.00 | -17.50 | AVG |

| | | | |
|---------------|---------------------------------|-------------|--------|
| EUT: | Anti-Lost Wireless Powerbank | Model Name: | PB002M |
| Test Mode: | Charging+TX | Phase: | N |
| Test Voltage: | DC 5V from adapter AC 120V/60Hz | | |

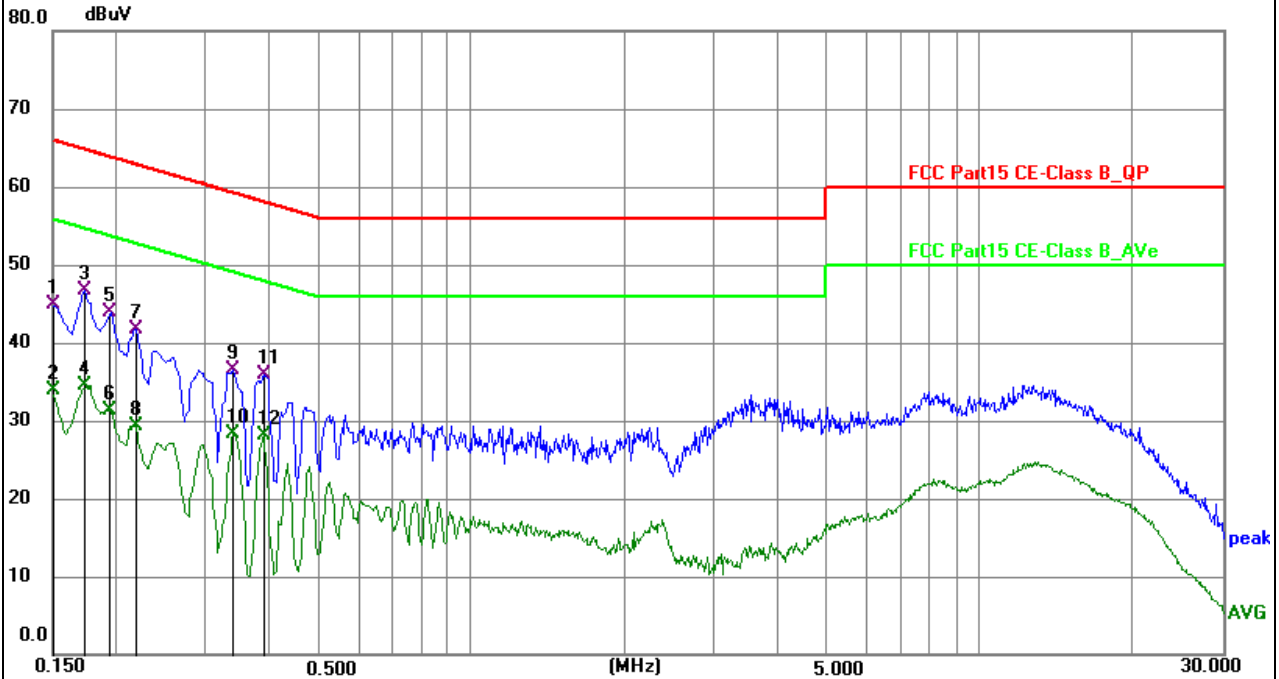

| No. | Frequency (MHz) | Reading (dBuV) | Factor (dB) | Level (dBuV) | Limit (dBuV) | Margin (dB) | Detector |
|-----|-----------------|----------------|-------------|--------------|--------------|-------------|----------|
| 1 | 0.150000 | 34.85 | 10.15 | 45.00 | 66.00 | -21.00 | QP |
| 2 | 0.150000 | 23.69 | 10.15 | 33.84 | 56.00 | -22.16 | AVG |
| 3 * | 0.172400 | 36.50 | 10.11 | 46.61 | 64.84 | -18.23 | QP |
| 4 | 0.172400 | 24.38 | 10.11 | 34.49 | 54.84 | -20.35 | AVG |
| 5 | 0.194900 | 33.77 | 10.08 | 43.85 | 63.83 | -19.98 | QP |
| 6 | 0.194900 | 21.22 | 10.08 | 31.30 | 53.83 | -22.53 | AVG |
| 7 | 0.217400 | 31.66 | 10.07 | 41.73 | 62.92 | -21.19 | QP |
| 8 | 0.217400 | 19.31 | 10.07 | 29.38 | 52.92 | -23.54 | AVG |
| 9 | 0.339000 | 26.39 | 10.09 | 36.48 | 59.23 | -22.75 | QP |
| 10 | 0.339000 | 18.24 | 10.09 | 28.33 | 49.23 | -20.90 | AVG |
| 11 | 0.388500 | 25.75 | 10.10 | 35.85 | 58.10 | -22.25 | QP |
| 12 | 0.388500 | 18.08 | 10.10 | 28.18 | 48.10 | -19.92 | AVG |

5.3 Radiated Emission

5.3.1 Limits

| Frequencies (MHz) | Field Strength (micovolts/meter) | Measurement Distance (meters) |
|-------------------|----------------------------------|-------------------------------|
| 0.009~0.490 | 2400/F(KHz) | 300 |
| 0.490~1.705 | 24000/F(KHz) | 30 |
| 1.705~30.0 | 30 | 30 |
| 30~88 | 100 | 3 |
| 88~216 | 150 | 3 |
| 216~960 | 200 | 3 |
| Above 960 | 500 | 3 |

| Receiver Parameter | Setting |
|------------------------|----------------------------------|
| Attenuation | Auto |
| Start ~ Stop Frequency | 9kHz~150kHz / RB 200Hz for QP |
| Start ~ Stop Frequency | 150kHz~30MHz / RB 9kHz for QP |
| Start ~ Stop Frequency | 30MHz~1000MHz / RB 120kHz for QP |

5.3.2 Test Procedures

- a) The radiated emission tests were performed in the 3 meters.
- b) The EUT was placed on the top of a rotating table 0.8 meters above the ground. The table was rotated 360 degrees to determine the position of the highest radiation.
- c) The height of the test antenna shall vary between 1m to 4m. Both horizontal and vertical polarizations of the antenna are set to make the measurement.
- d) If the peak mode measured value compliance with and lower than quasi peak mode limit, the EUT shall be deemed to meet QP limits and then no additional QP mode measurement performed.
- e) If the peak mode measured value compliance with and lower than average mode limit, the EUT shall be deemed to meet average limits and then no additional average mode measurement performed.
- f) For the actual test configuration, please refer to the related item – EUT test photos.

5.3.3 Test Setup

Radiated Emission Test-Up Frequency Below 30MHz

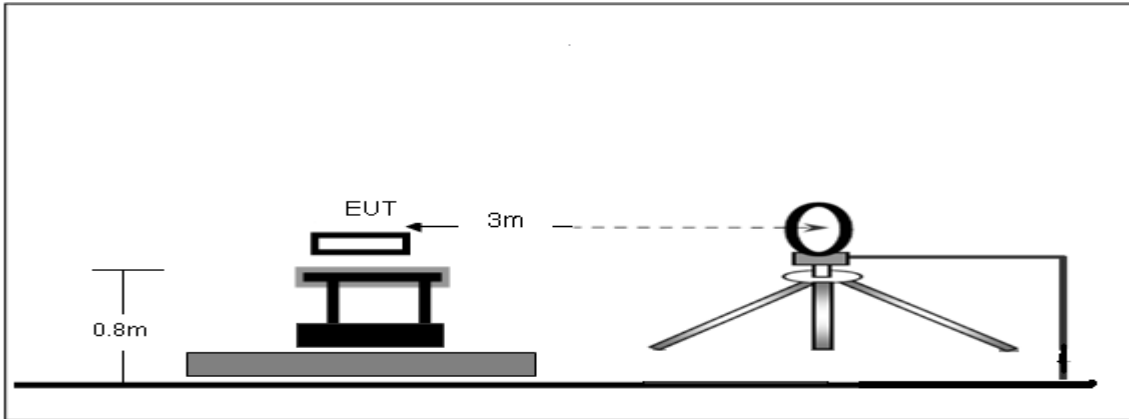

Radiated Emission Test-Up Frequency 30MHz~1GHz

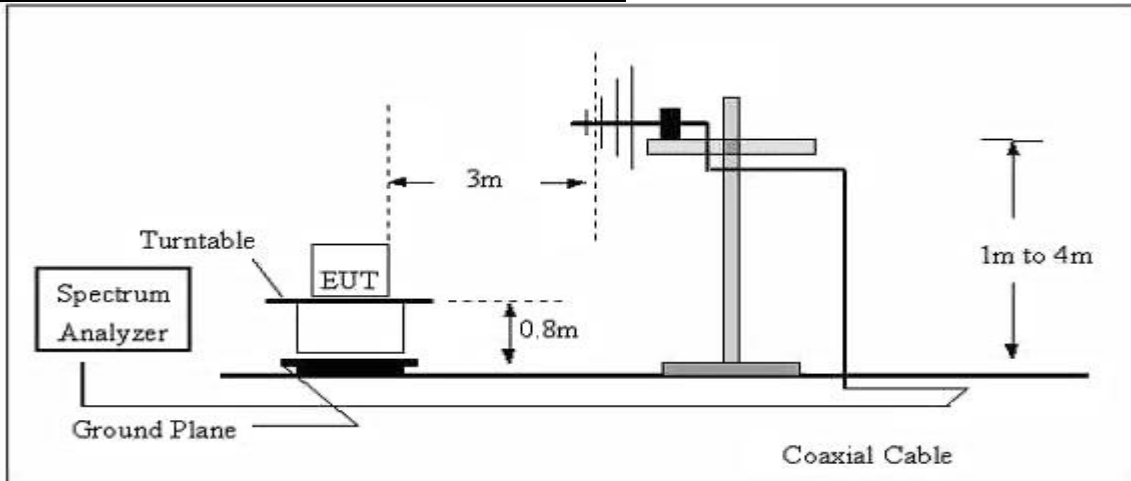

Radiated emission test-up frequency above 1GHz

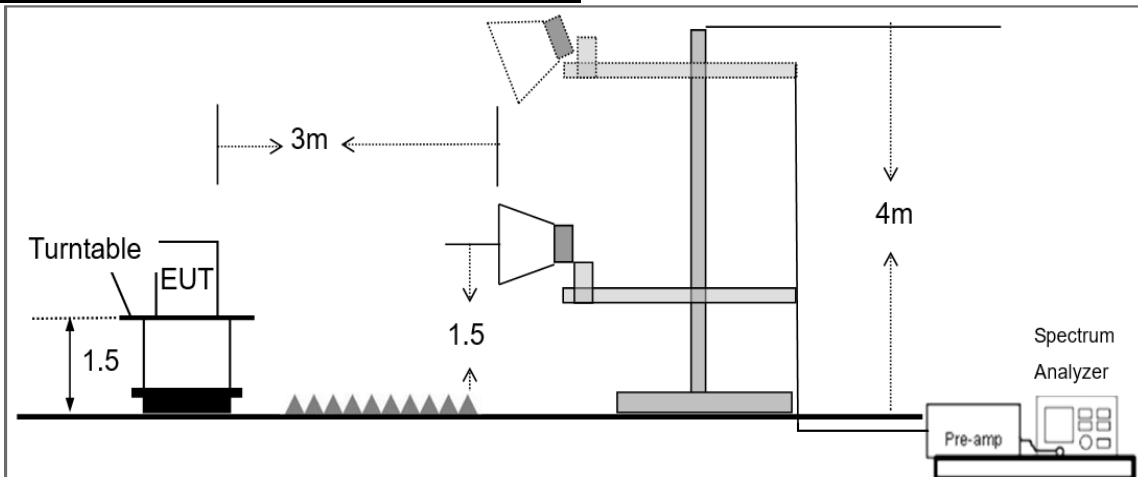

5.3.4 Test Result

Below 30MHz

| | | | |
|------------|------------------------------|----------------|------------------------------------|
| EUT: | Anti-Lost Wireless Powerbank | Model Name: | PB002M |
| Pressure: | 1010 hPa | Test Voltage: | DC 5V from adapter AC 120V/60Hz |
| Test Mode: | Charging+TX | Polarization:: | -- |

| Freq. | Reading | Limit | Margin | State |
|-------|----------|----------|--------|-------|
| (MHz) | (dBuV/m) | (dBuV/m) | (dB) | P/F |
| -- | -- | -- | -- | Pass |
| -- | -- | -- | -- | Pass |

Note:

1. For 9kHz-30MHz, the amplitude of spurious emissions which are attenuated by more than 20dB below the permissible value has no need to be reported.
2. Distance extrapolation factor = $40 \log (\text{specific distance}/\text{test distance})$ (dB);
3. Limit line = specific limits (dBuV) + distance extrapolation factor.

Frequency range (30MHz – 1GHz)

| | | | |
|---------------|---------------------------------|-------------|----------|
| EUT: | Anti-Lost Wireless Powerbank | Model Name: | PB002M |
| Test Mode: | Charging+TX | Phase: | Vertical |
| Test Voltage: | DC 5V from adapter AC 120V/60Hz | | |

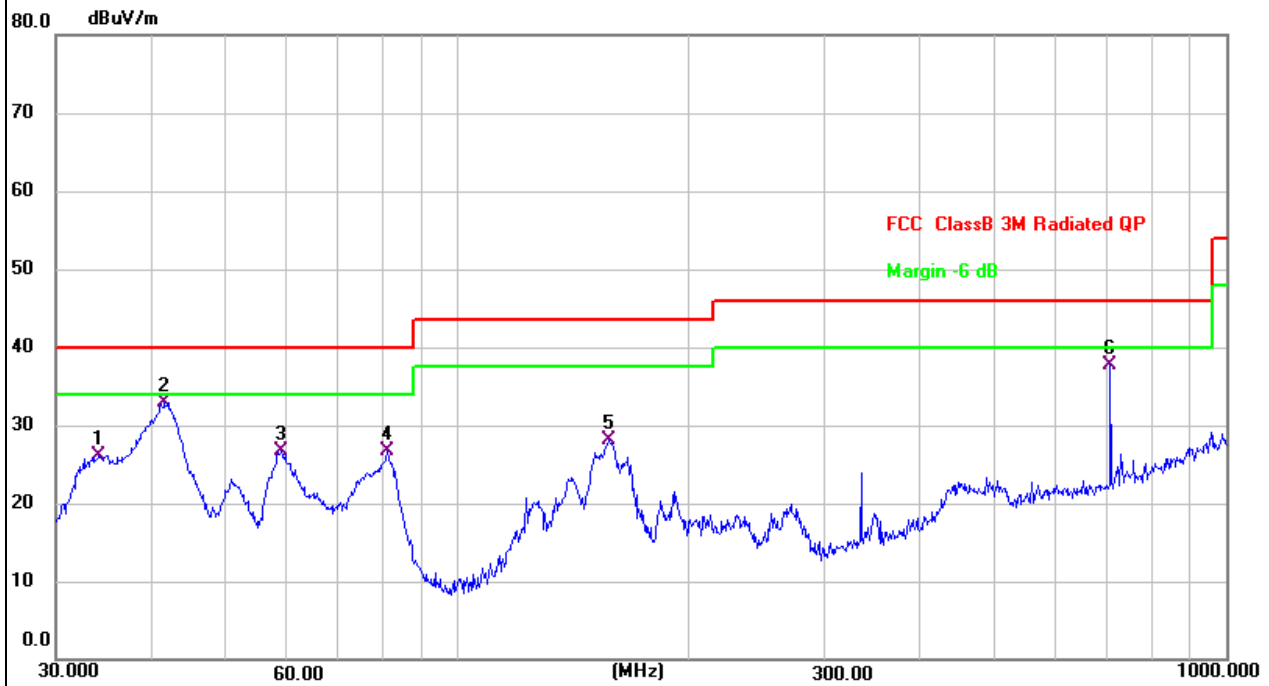

| No. | Frequency (MHz) | Reading (dBuV) | Factor (dB/m) | Level (dBuV/m) | Limit (dBuV/m) | Margin (dB) | Detector |
|-----|-----------------|----------------|---------------|----------------|----------------|-------------|----------|
| 1 | 34.1560 | 41.20 | -15.12 | 26.08 | 40.00 | -13.92 | QP |
| 2 * | 41.5670 | 47.05 | -14.08 | 32.97 | 40.00 | -7.03 | QP |
| 3 | 59.0251 | 41.81 | -15.14 | 26.67 | 40.00 | -13.33 | QP |
| 4 | 80.9274 | 45.61 | -18.89 | 26.72 | 40.00 | -13.28 | QP |
| 5 | 157.5588 | 41.83 | -13.70 | 28.13 | 43.50 | -15.37 | QP |
| 6 | 706.6998 | 40.69 | -3.02 | 37.67 | 46.00 | -8.33 | QP |

| | | | |
|---------------|---------------------------------|-------------|------------|
| EUT: | Anti-Lost Wireless Powerbank | Model Name: | PB002M |
| Test Mode: | Charging+TX | Phase: | Horizontal |
| Test Voltage: | DC 5V from adapter AC 120V/60Hz | | |

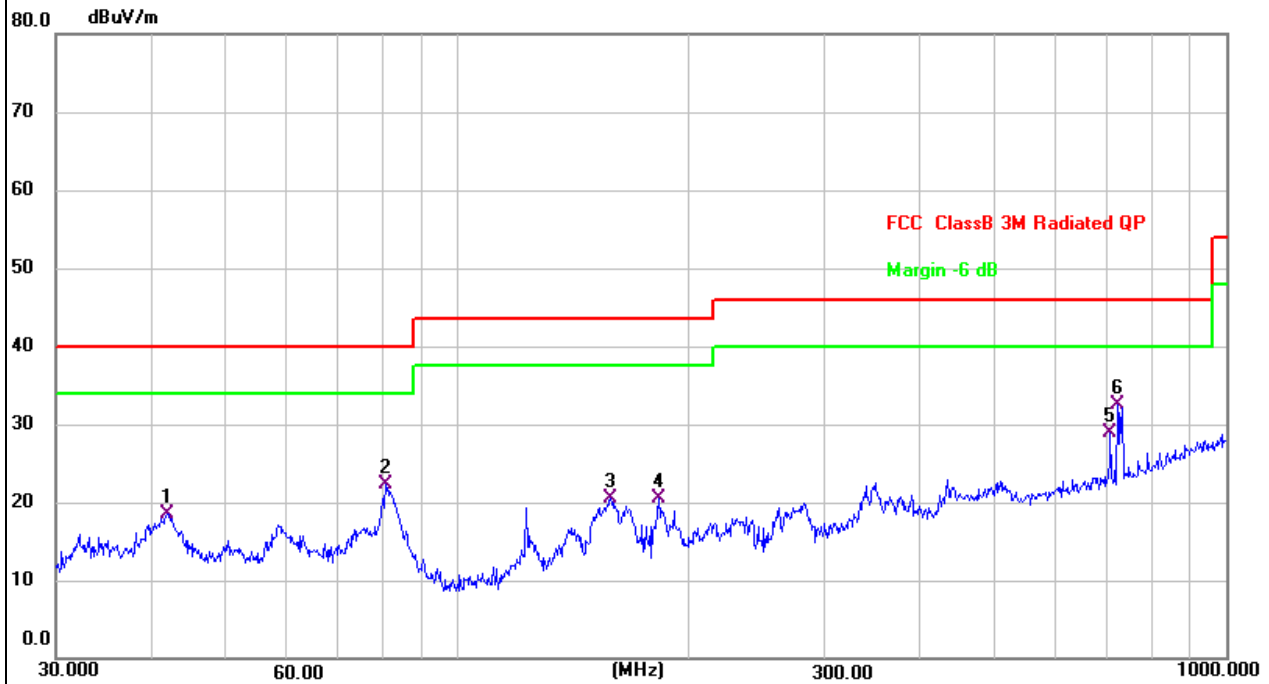

| No. | Frequency (MHz) | Reading (dBuV) | Factor (dB/m) | Level (dBuV/m) | Limit (dBuV/m) | Margin (dB) | Detector |
|-----|-----------------|----------------|---------------|----------------|----------------|-------------|----------|
| 1 | 41.8595 | 32.64 | -14.10 | 18.54 | 40.00 | -21.46 | QP |
| 2 | 80.6441 | 41.13 | -18.88 | 22.25 | 40.00 | -17.75 | QP |
| 3 | 158.1123 | 34.26 | -13.69 | 20.57 | 43.50 | -22.93 | QP |
| 4 | 182.5592 | 35.91 | -15.40 | 20.51 | 43.50 | -22.99 | QP |
| 5 | 706.6998 | 31.97 | -3.02 | 28.95 | 46.00 | -17.05 | QP |
| 6 * | 721.7258 | 35.16 | -2.72 | 32.44 | 46.00 | -13.56 | QP |

5.3.5 Band Edge - Radiated

| Frequency | Meter Reading | Cable Loss | Antenna Factor | Preamp Factor | Emission Level | Limits | Margin | Detector | Comment |
|-------------|---------------|------------|----------------|---------------|----------------|----------|--------|----------|------------|
| (MHz) | (dBμV) | (dB) | dB/m | (dB) | (dBμV/m) | (dBμV/m) | (dB) | Type | |
| GFSK | | | | | | | | | |
| 2310.00 | 63.67 | 2.40 | 27.70 | 40.40 | 53.37 | 74 | -20.63 | Pk | Horizontal |
| 2310.00 | 42.50 | 2.40 | 27.70 | 40.40 | 32.20 | 54 | -21.80 | AV | Horizontal |
| 2310.00 | 61.19 | 2.40 | 27.70 | 40.40 | 50.89 | 74 | -23.11 | Pk | Vertical |
| 2310.00 | 42.46 | 2.40 | 27.70 | 40.40 | 32.16 | 54 | -21.84 | AV | Vertical |
| 2390.00 | 64.26 | 2.44 | 28.30 | 40.10 | 54.90 | 74 | -19.10 | Pk | Vertical |
| 2390.00 | 43.22 | 2.44 | 28.30 | 40.10 | 33.86 | 54 | -20.14 | AV | Vertical |
| 2390.00 | 63.76 | 2.44 | 28.30 | 40.10 | 54.40 | 74 | -19.60 | Pk | Horizontal |
| 2390.00 | 41.83 | 2.44 | 28.30 | 40.10 | 32.47 | 54 | -21.53 | AV | Horizontal |
| 2483.50 | 62.32 | 2.48 | 28.70 | 39.80 | 53.70 | 74 | -20.30 | Pk | Vertical |
| 2483.50 | 42.72 | 2.48 | 28.70 | 39.80 | 34.10 | 54 | -19.90 | AV | Vertical |
| 2483.50 | 65.71 | 2.48 | 28.70 | 39.80 | 57.09 | 74 | -16.91 | Pk | Horizontal |
| 2483.50 | 43.78 | 2.48 | 28.70 | 39.80 | 35.16 | 54 | -18.84 | AV | Horizontal |

Remark:

1. Emission Level = Meter Reading + Antenna Factor + Cable Loss – Pre-amplifier, Margin= Emission Level - Limit

5.3.6 Spurious emission in restricted band 1GHz-25GHz

All the modulation modes have been tested, and the worst result was report as below:

| Frequency | Reading Level | Cable Loss | Antenna Factor | Preamp Factor | Emission Level | Limits | Margin | Detector | Comment |
|--|---------------|------------|----------------|---------------|----------------|----------|--------|----------|------------|
| (MHz) | (dBμV) | (dB) | dB/m | (dB) | (dBμV/m) | (dBμV/m) | (dB) | Type | |
| Low Channel (2402 MHz)(GFSK)--Above 1G | | | | | | | | | |
| 4804.338 | 62.27 | 4.36 | 32.92 | 45.53 | 54.02 | 74.00 | -19.98 | Pk | Vertical |
| 4804.338 | 42.72 | 4.36 | 32.92 | 45.53 | 34.47 | 54.00 | -19.53 | AV | Vertical |
| 7206.107 | 60.98 | 5.02 | 37.63 | 45.56 | 58.07 | 74.00 | -15.93 | Pk | Horizontal |
| 7206.107 | 42.39 | 5.02 | 37.63 | 45.56 | 39.48 | 54.00 | -14.52 | AV | Horizontal |
| 4804.169 | 62.87 | 4.36 | 32.92 | 45.53 | 54.62 | 74.00 | -19.38 | Pk | Vertical |
| 4804.169 | 42.70 | 4.36 | 32.92 | 45.53 | 34.45 | 54.00 | -19.55 | AV | Vertical |
| 7206.214 | 62.18 | 5.02 | 37.63 | 45.56 | 59.27 | 74.00 | -14.73 | Pk | Horizontal |
| 7206.214 | 42.39 | 5.02 | 37.63 | 45.56 | 39.48 | 54.00 | -14.52 | AV | Horizontal |
| Mid Channel (2440 MHz)(GFSK)--Above 1G | | | | | | | | | |
| 4880.473 | 63.52 | 4.41 | 33.01 | 45.76 | 55.18 | 74.00 | -18.82 | Pk | Vertical |
| 4880.473 | 44.07 | 4.41 | 33.01 | 45.76 | 35.73 | 54.00 | -18.27 | AV | Vertical |
| 7320.265 | 64.38 | 5.02 | 37.68 | 45.59 | 61.49 | 74.00 | -12.51 | Pk | Horizontal |
| 7320.265 | 41.41 | 5.02 | 37.68 | 45.59 | 38.52 | 54.00 | -15.48 | AV | Horizontal |
| 4880.366 | 62.21 | 4.41 | 33.01 | 45.76 | 53.87 | 74.00 | -20.13 | Pk | Vertical |
| 4880.366 | 41.94 | 4.41 | 33.01 | 45.76 | 33.60 | 54.00 | -20.40 | AV | Vertical |
| 7320.234 | 60.16 | 5.02 | 37.68 | 45.59 | 57.27 | 74.00 | -16.73 | Pk | Horizontal |
| 7320.234 | 44.63 | 5.02 | 37.68 | 45.59 | 41.74 | 54.00 | -12.26 | AV | Horizontal |
| High Channel (2480 MHz)(GFSK)-- Above 1G | | | | | | | | | |
| 4960.482 | 62.99 | 4.50 | 33.26 | 46.07 | 54.68 | 74.00 | -19.32 | Pk | Vertical |
| 4960.482 | 42.95 | 4.50 | 33.26 | 46.07 | 34.64 | 54.00 | -19.36 | AV | Vertical |
| 7440.131 | 63.98 | 5.02 | 37.78 | 45.77 | 61.01 | 74.00 | -12.99 | Pk | Horizontal |
| 7440.131 | 48.28 | 5.02 | 37.78 | 45.77 | 45.31 | 54.00 | -8.69 | AV | Horizontal |
| 4960.326 | 62.79 | 4.50 | 33.26 | 46.07 | 54.48 | 74.00 | -19.52 | Pk | Vertical |
| 4960.326 | 45.33 | 4.50 | 33.26 | 46.07 | 37.02 | 54.00 | -16.98 | AV | Vertical |
| 7440.199 | 64.54 | 5.02 | 37.78 | 45.77 | 61.57 | 74.00 | -12.43 | Pk | Horizontal |
| 7440.199 | 45.98 | 5.02 | 37.78 | 45.77 | 43.01 | 54.00 | -10.99 | AV | Horizontal |

Remark:

1. Emission Level = Meter Reading + Antenna Factor + Cable Loss – Pre-amplifier, Margin= Emission Level - Limit
2. If peak below the average limit, the average emission was no test.
3. The amplitude of spurious emissions which are attenuated by more than 20dB below the permissible value has no need to be reported.
4. All the modulation modes have been tested, and the worst result was report as below.

5.4 Peak Output Power

5.4.1 Limit

| FCC Part15 Subpart C | | | |
|----------------------|-------------------|-----------------|-----------------------|
| Section | Test Item | Limit | Frequency Range (MHz) |
| 15.247(b)(3) | Peak output power | 1 watt or 30dBm | 2400-2483.5 |

5.4.2 Test Procedure

- (1) The EUT was directly connected to the spectrum analyzer and antenna output port as show in the block diagram above.
- (2) Spectrum Setting:
RBW=2MHz, VBW=10MHz, Detector=Peak
- (3) The EUT was set to continuously transmitting in the max power during the test.

5.4.3 Test Setup

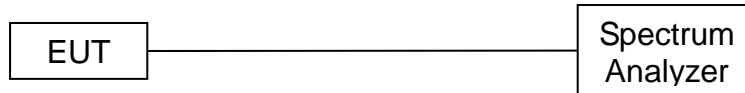

5.4.4 Test Results

| | | | |
|------------|------------------------------|---------------|-----------------------|
| EUT: | Anti-Lost Wireless Powerbank | Model Name: | PB002M |
| Test Mode: | TX | Test Voltage: | DC 3.87V from battery |

| BLE 1M | | | |
|--------------|-----------------|--------------------------------|-------------|
| Test Channel | Frequency (MHz) | Maximum Peak Output Power(dBm) | Limit (dBm) |
| CH00 | 2402 | 0.26 | 30 |
| CH19 | 2440 | 0.11 | 30 |
| CH39 | 2480 | -0.34 | 30 |

| BLE 2M | | | |
|--------------|-----------------|--------------------------------|-------------|
| Test Channel | Frequency (MHz) | Maximum Peak Output Power(dBm) | Limit (dBm) |
| CH00 | 2402 | 0.3 | 30 |
| CH19 | 2440 | 0.12 | 30 |
| CH39 | 2480 | -0.31 | 30 |

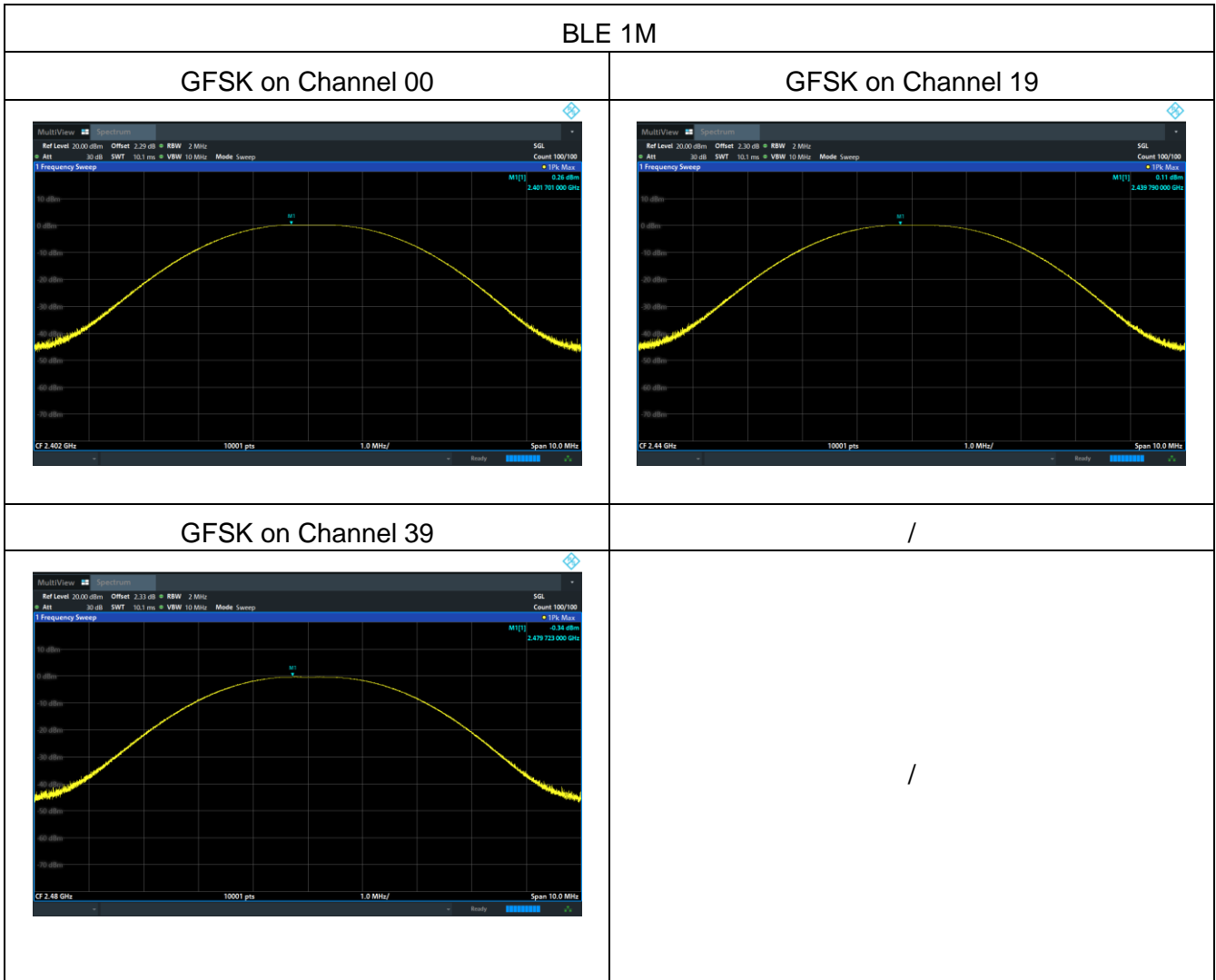

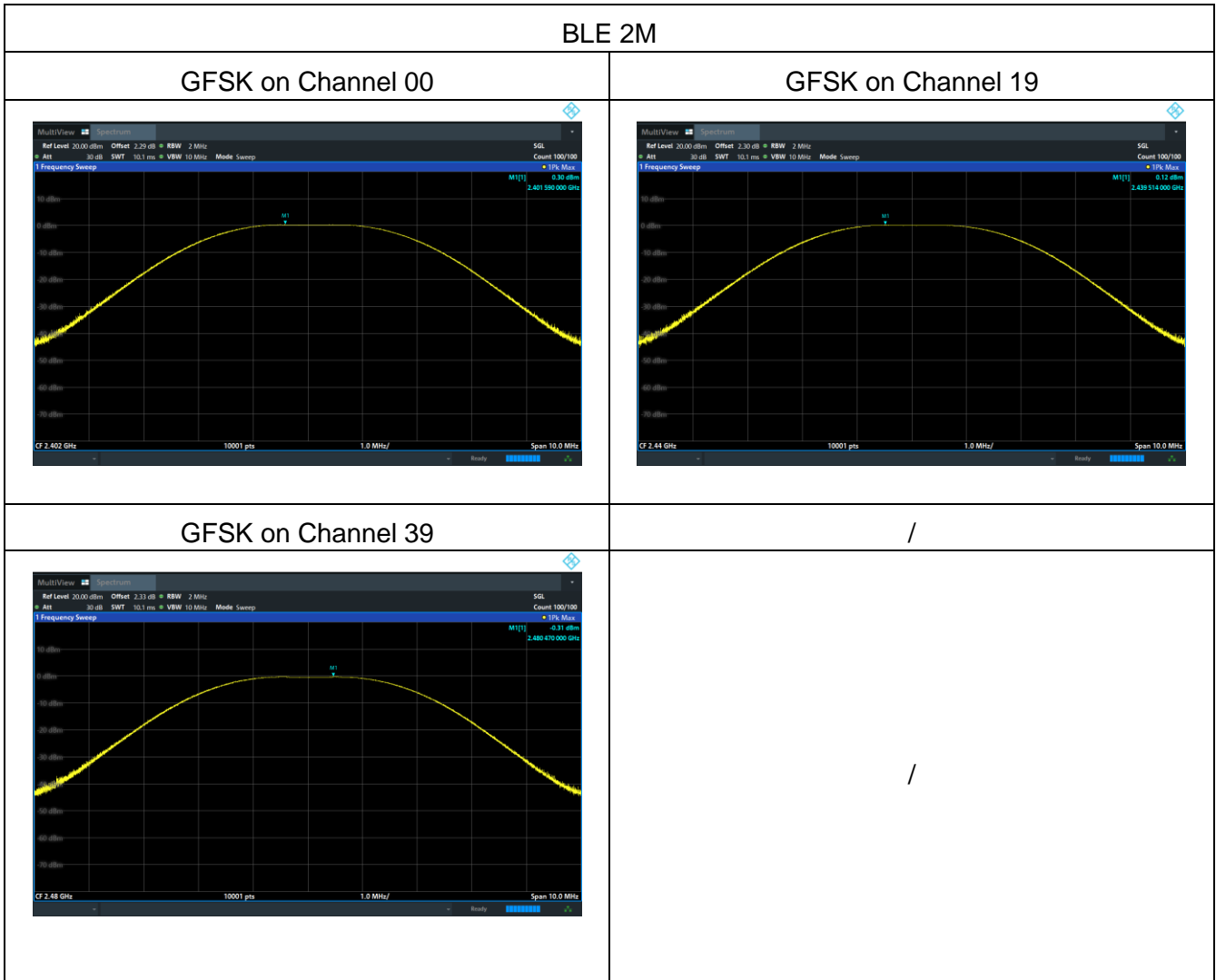

5.5 Power Spectral Density

5.5.1 Limit

| FCC Part15 (15.247) , Subpart C | | | |
|---------------------------------|------------------------|------------------------|-----------------------|
| Section | Test Item | Limit | Frequency Range (MHz) |
| 15.247 | Power Spectral Density | 8 dBm (in any 3kHz) | 2400-2483.5 |

5.5.2 Test Procedure

1. Set analyzer center frequency to DTS channel center frequency.
2. Set the span to 1.5 times the DTS channel bandwidth.
3. Set the RBW \geq 3 kHz.
4. Set the VBW \geq 3 x RBW.
5. Detector = peak.
6. Sweep time = auto couple.
7. Trace mode = max hold.
8. Allow trace to fully stabilize.
9. Use the peak marker function to determine the maximum amplitude level.
10. If measured value exceeds limit, reduce RBW (no less than 3 kHz) and repeat.

5.5.3 Test Setup

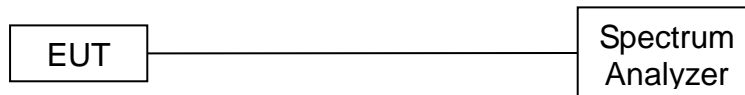

5.5.4 Test Results

| | | | |
|------------|------------------------------|---------------|-----------------------|
| EUT: | Anti-Lost Wireless Powerbank | Model Name: | PB002M |
| Pressure: | 1015 hPa | Test Voltage: | DC 3.87V from battery |
| Test Mode: | TX Mode /CH00, CH19, CH39 | | |

| BLE 1M | | | |
|-----------|--------------------------|------------------|--------|
| Frequency | Power Density (dBm/3kHz) | Limit (dBm/3kHz) | Result |
| 2402 MHz | -14.82 | 8 | Pass |
| 2440 MHz | -17.14 | 8 | Pass |
| 2480 MHz | -15.22 | 8 | Pass |

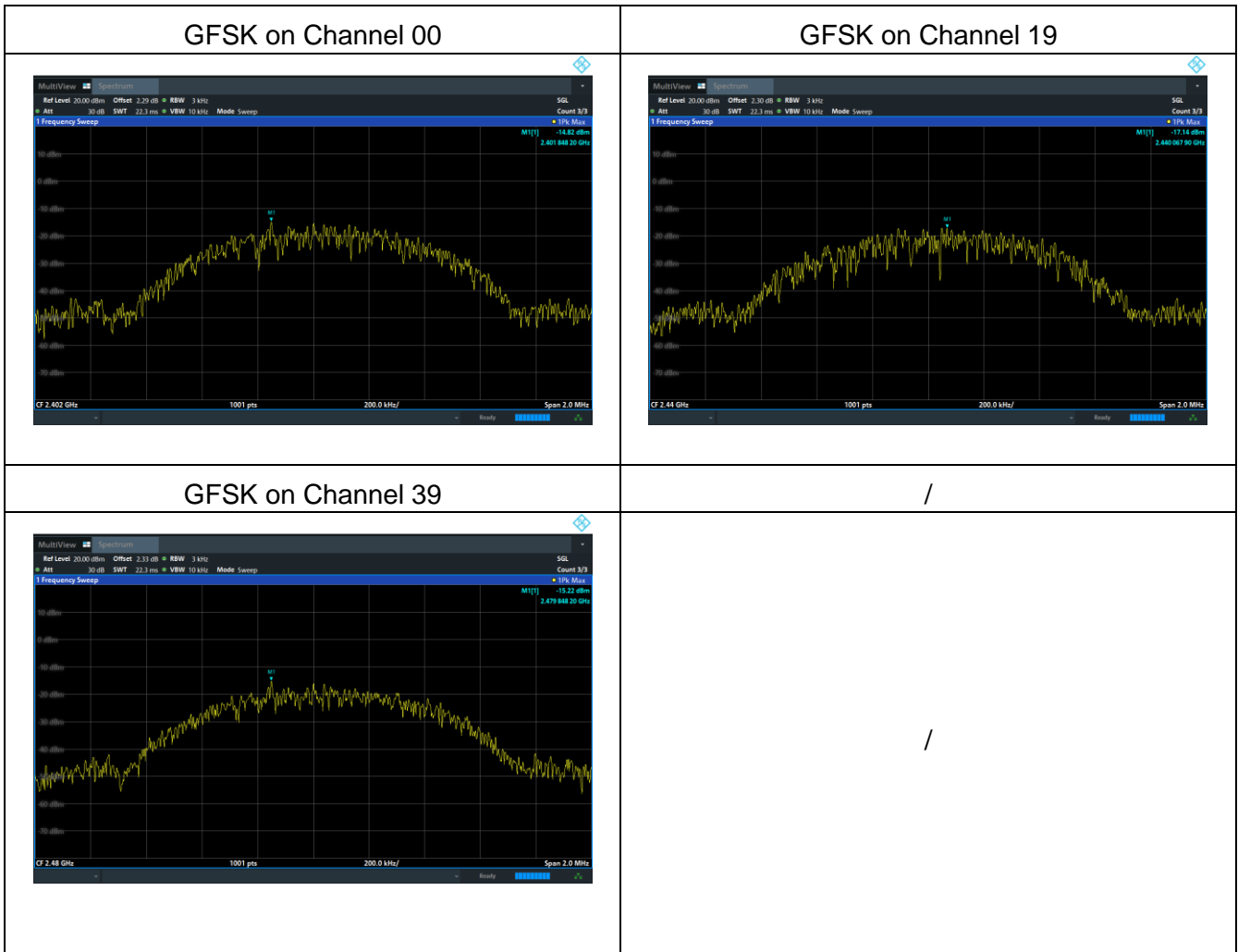

| BLE 2M | | | |
|-----------|--------------------------|------------------|--------|
| Frequency | Power Density (dBm/3kHz) | Limit (dBm/3kHz) | Result |
| 2402 MHz | -18.14 | 8 | Pass |
| 2440 MHz | -17.88 | 8 | Pass |
| 2480 MHz | -18.95 | 8 | Pass |

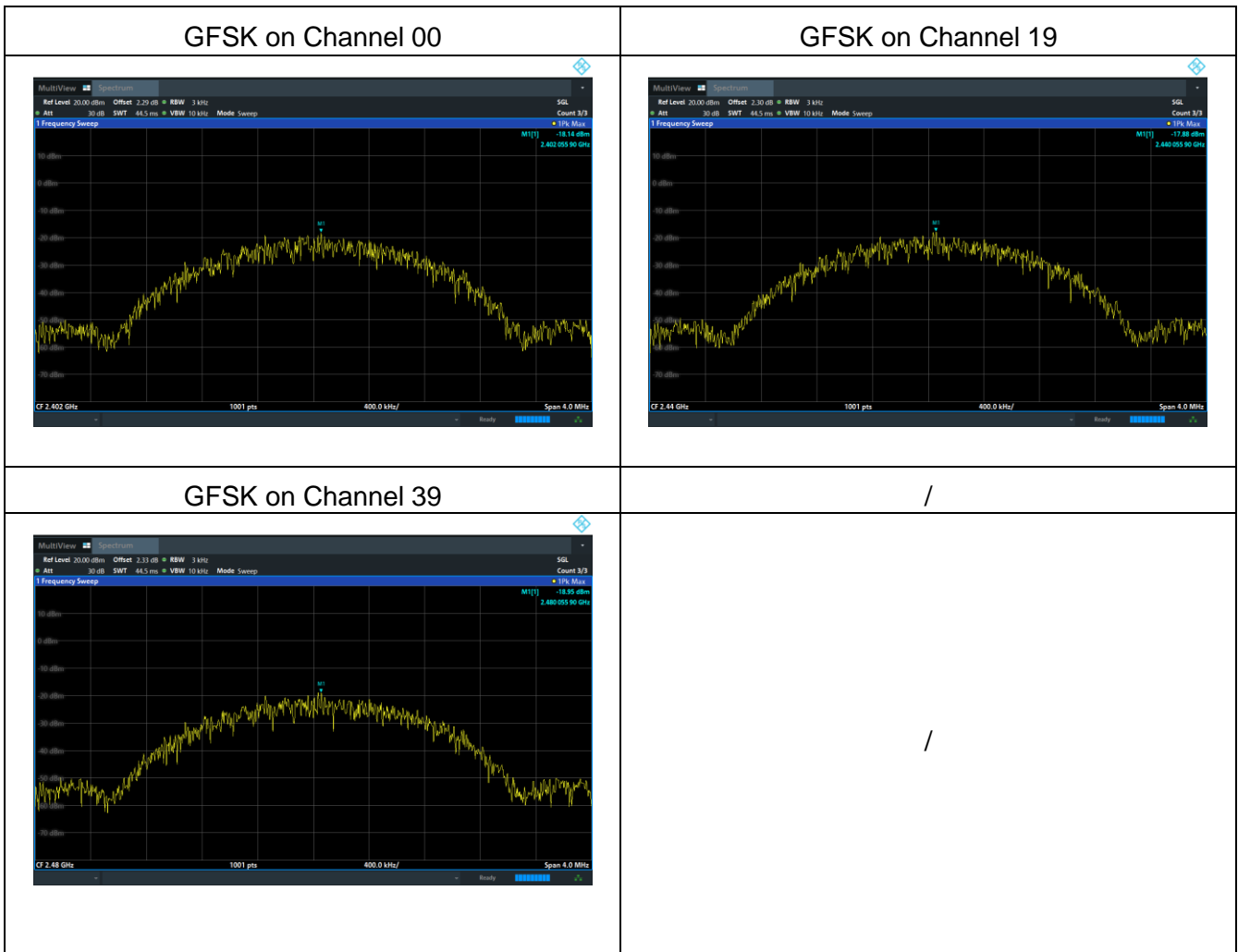

5.6 6dB Bandwidth

5.6.1 Limit

| FCC Part15 (15.247) , Subpart C | | | |
|---------------------------------|-----------|---|-----------------------|
| Section | Test Item | Limit | Frequency Range (MHz) |
| 15.247(a)(2) | Bandwidth | $\geq 500\text{kHz}$ (6dB bandwidth) | 2400-2483.5 |

5.6.2 Test Procedure

1. Set RBW= 100 kHz.
2. Set the video bandwidth (VBW) $\geq 3 \times$ RBW.
3. Detector = Peak.
4. Trace mode = max hold.
5. Sweep = auto couple.
6. Allow the trace to stabilize.
7. Measure the maximum width of the emission that is constrained by the frequencies associated with the two outermost amplitude points (upper and lower) that are attenuated by 6 dB relative to the maximum level measured in the fundamental emission.

5.6.3 Test Setup

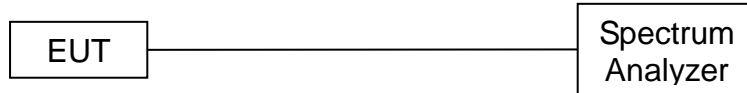

5.6.4 Test Results

| | | | |
|------------|------------------------------|---------------|-----------------------|
| EUT: | Anti-Lost Wireless Powerbank | Model Name: | PB002M |
| Pressure: | 1012 hPa | Test Voltage: | DC 3.87V from battery |
| Test Mode: | GFSK/CH00, CH19, CH39 | | |

| BLE 1M | | | | |
|---------|-----------------|---------------------|-------------|--------|
| Channel | Frequency (MHz) | 6dB bandwidth (MHz) | Limit (kHz) | Result |
| Low | 2402 | 0.757 | 500 | Pass |
| Middle | 2440 | 0.763 | 500 | Pass |
| High | 2480 | 0.774 | 500 | Pass |

Test plots

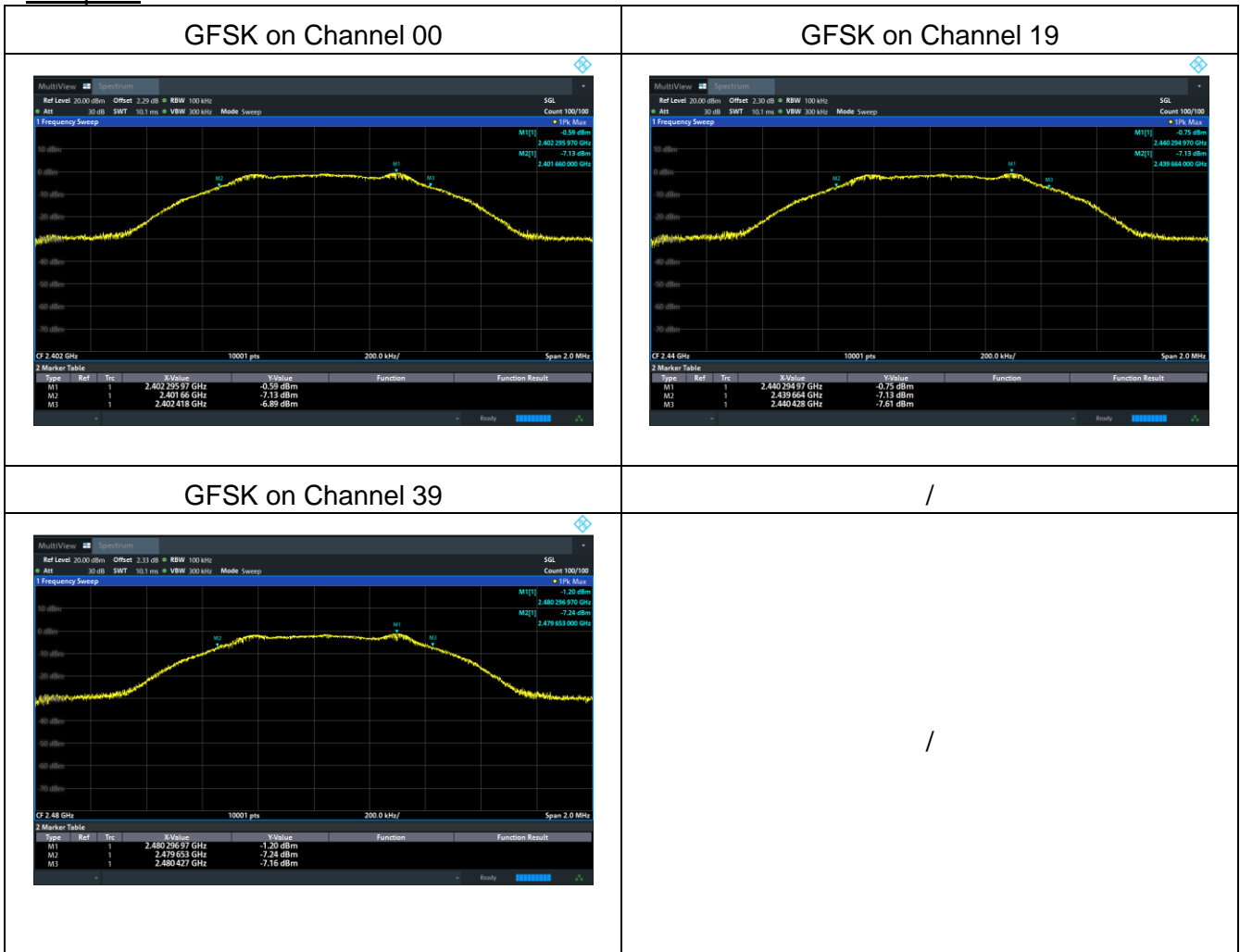

Note: 6dB Bandwidth=M3-M2

| BLE 2M | | | | |
|---------|-----------------|---------------------|-------------|--------|
| Channel | Frequency (MHz) | 6dB bandwidth (MHz) | Limit (kHz) | Result |
| Low | 2402 | 1.407 | 500 | Pass |
| Middle | 2440 | 1.402 | 500 | Pass |
| High | 2480 | 1.408 | 500 | Pass |

Test plots:

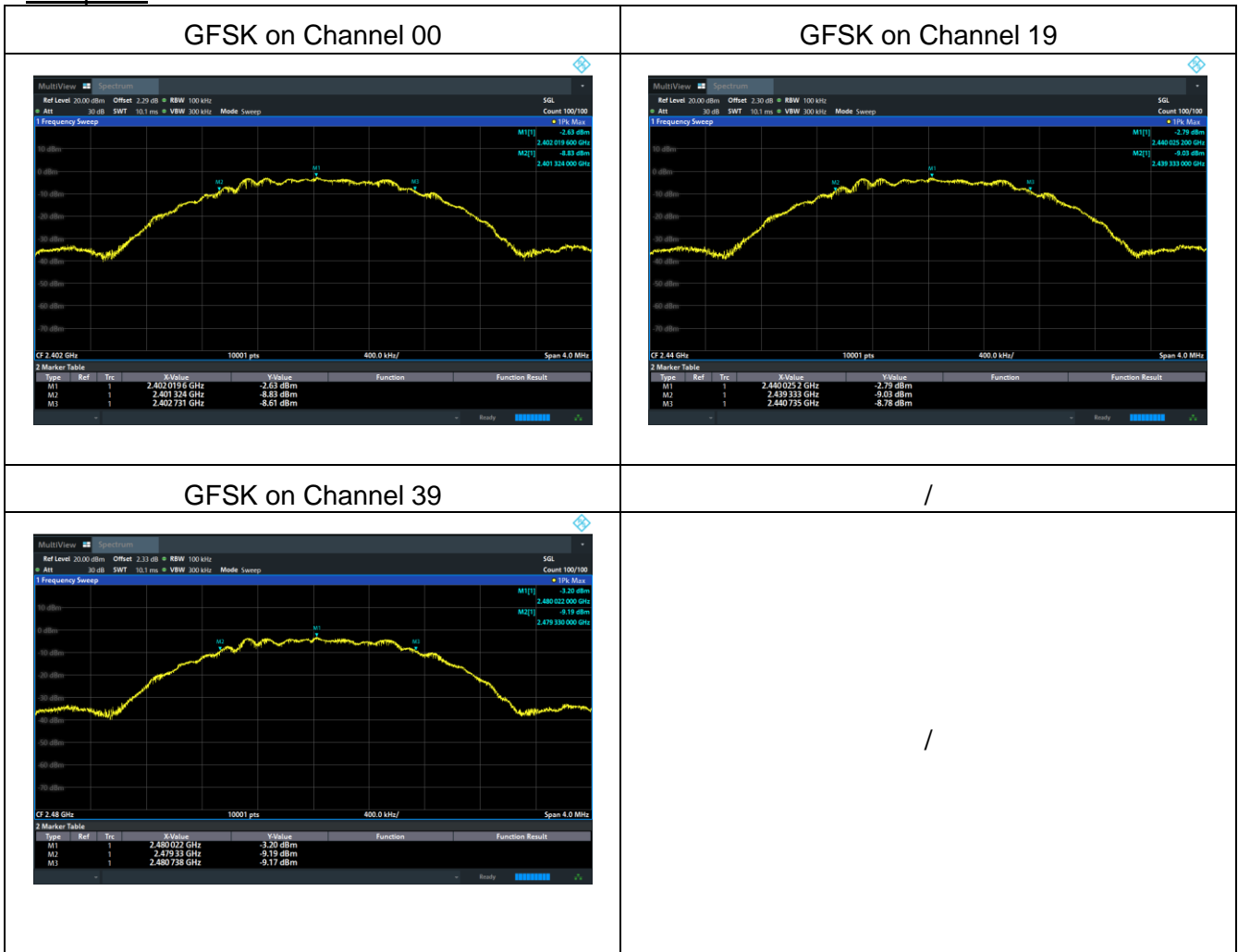

Note: 6dB Bandwidth=M3-M2

5.7 Duty Cycle

5.7.1 Limit

No limit requirement.

5.7.2 Test Procedure

The zero-span mode on a spectrum analyzer or EMI receiver if the response time and spacing between bins on the sweep are sufficient to permit accurate measurements of the on and off times of the transmitted signal. Set the center frequency of the instrument to the center frequency of the transmission. Set $RBW \geq OBW$ if possible; otherwise, set RBW to the largest available value. Set $VBW \geq RBW$. Set detector = peak or average. The zero-span measurement method shall not be used unless both RBW and VBW are $> 50/T$ and the number of sweep points across duration T exceeds 100. (For example, if VBW and/or RBW are limited to 3 MHz, then the zero-span method of measuring duty cycle shall not be used if $T \leq 16.7$ microseconds.)

The transmitter output is connected to the Spectrum Analyzer. We tested according to the zero-span measurement method, 6.0(b) in KDB 558074 D01 DTS Meas Guidance v05r02.

The largest available value of RBW is 8 MHz and VBW is 50 MHz. The zero-span method of measuring duty cycle shall not be used if $T \leq 6.25$ microseconds. ($50/6.25 = 8$)

The zero-span method was used because all measured T data are > 6.25 microseconds and both RBW and VBW are $> 50/T$.

The RF output of EUT was connected to the spectrum analyzer by RF cable and attenuator.

The path loss was compensated to the results for each measurement.

Set to the maximum power setting and enable the EUT transmit continuously.

The EUT was operating in controlled its channel.

Use the following spectrum analyzer settings:

Span = Zero Span

RBW = 1MHz (the largest available value)

VBW = 3MHz (\geq RBW)

Number of points in Sweep >100

Detector function = peak

Trace = Clear write

Measure Total and Ton

Calculate Duty Cycle = $Ton / Total$

5.7.3 Test Setup

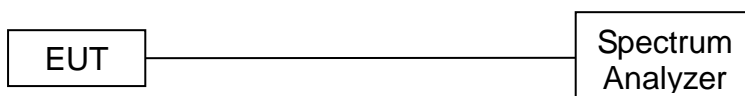

5.7.4 Test Results

| BLE 1M | | | |
|------------|------------------------------|---------------|-----------------------|
| EUT: | Anti-Lost Wireless Powerbank | Model Name: | PB002M |
| Pressure: | 1015 hPa | Test Voltage: | DC 3.87V from battery |
| Test Mode: | TX Mode /CH00, CH19, CH39 | | |

Test plots:



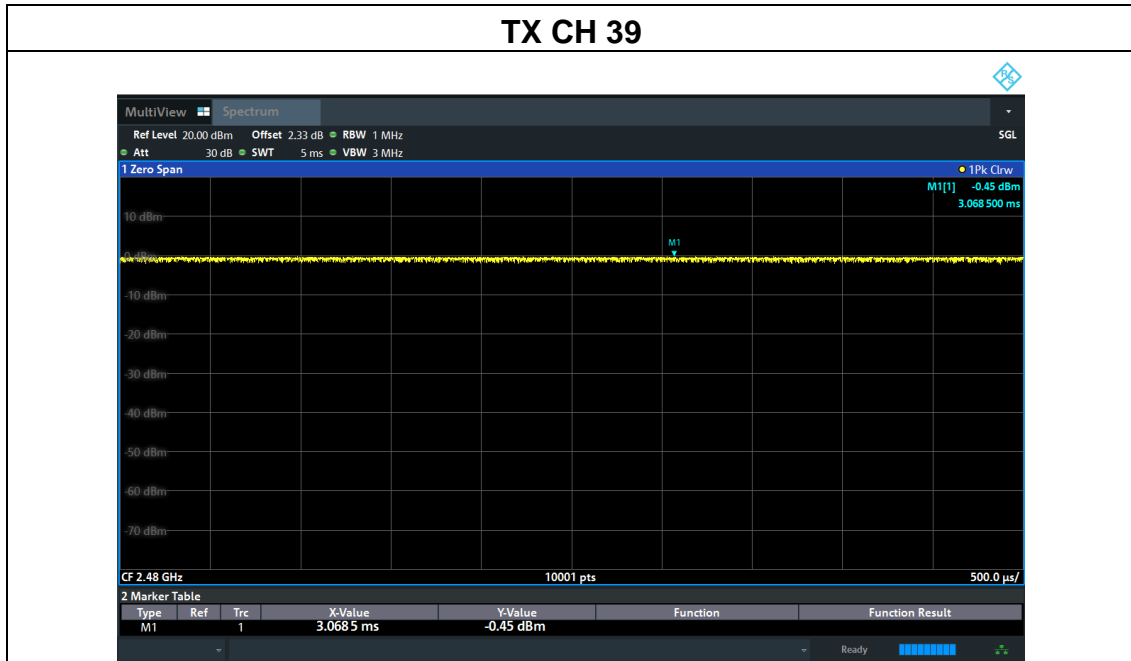

| BLE 2M | | | |
|------------|------------------------------|---------------|-----------------------|
| EUT: | Anti-Lost Wireless Powerbank | Model Name: | PB002M |
| Pressure: | 1015 hPa | Test Voltage: | DC 3.87V from battery |
| Test Mode: | TX Mode /CH00, CH19, CH39 | | |

Test plots

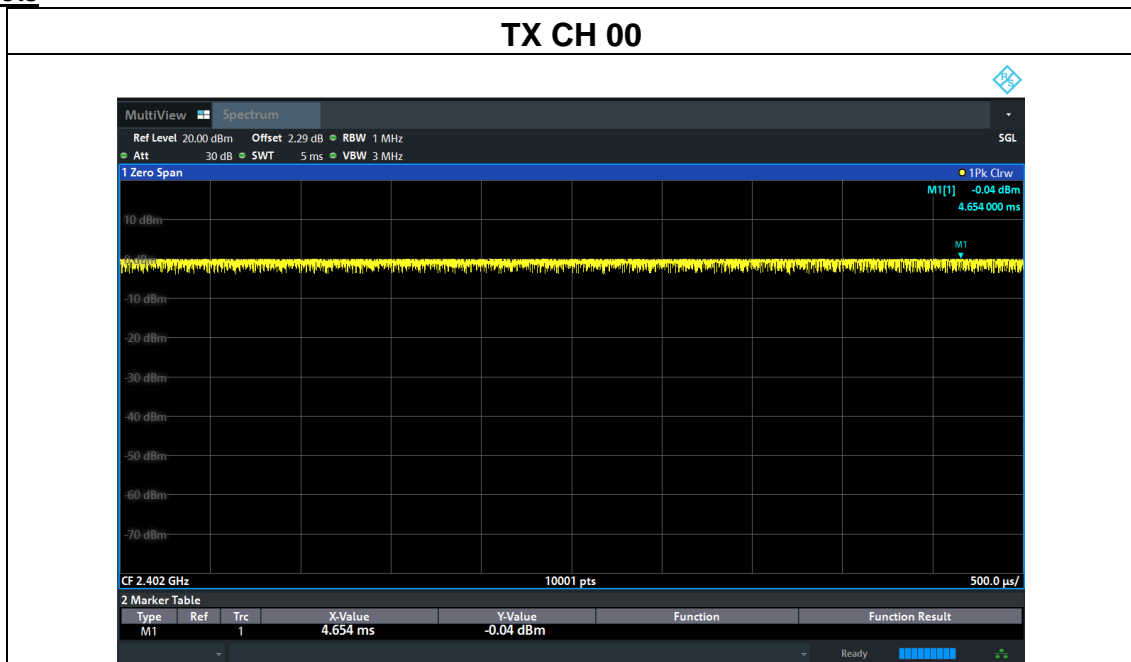

TX CH 19

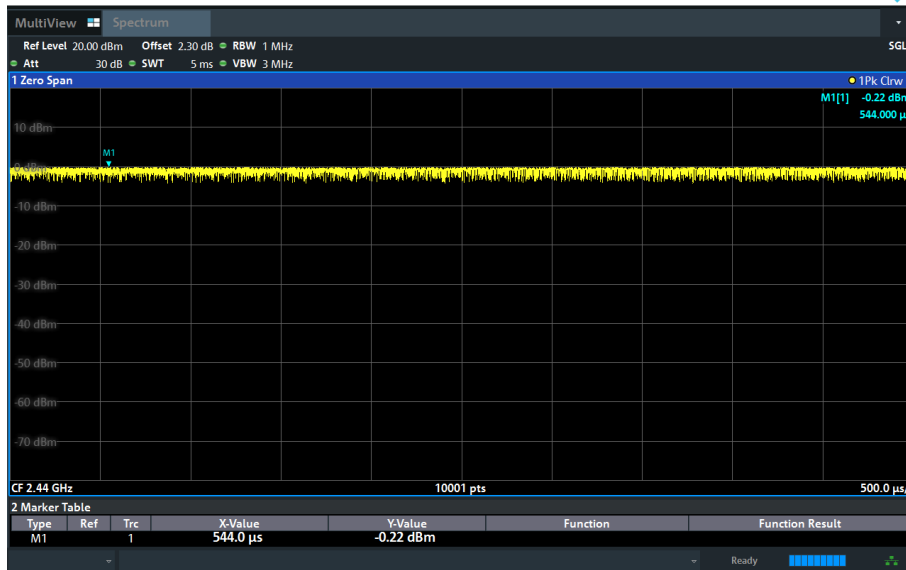

TX CH 39

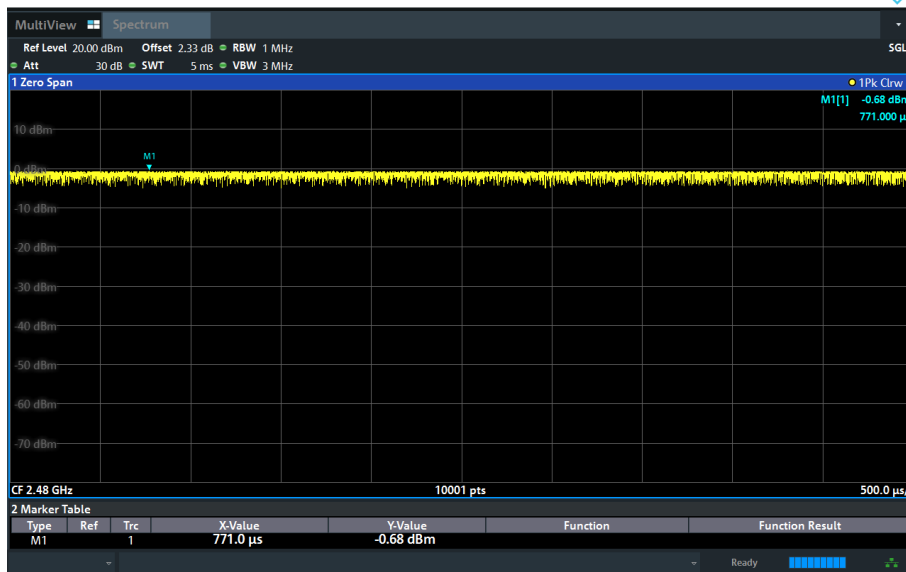

5.8 Conducted Band Edge

5.8.1 Limit

In any 100 kHz bandwidth outside the frequency band in which the spread spectrum or digitally modulated intentional radiator is operating, the radio frequency power that is produced by the intentional radiator shall be at least 20 dB below that in the 100 kHz bandwidth within the band that contains the highest level of the desired power, based on either an RF conducted or a radiated measurement, provided the transmitter demonstrates compliance with the peak conducted power limits. If the transmitter complies with the conducted power limits based on the use of RMS averaging over a time interval, as permitted under paragraph (b)(3) of this section, the attenuation required under this paragraph shall be 30 dB instead of 20 dB. Attenuation below the general limits specified in §15.209(a) is not required. In addition, radiated emissions which fall in the restricted bands, as defined in §15.205(a), must also comply with the radiated emission limits specified in §15.209(a) (see §15.205(c)).

5.8.2 Test Procedure

- a) Check the calibration of the measuring instrument using either an internal calibrator or a known signal from an external generator.
- b) Position the EUT without connection to measurement instrument. Turn on the EUT and connect its antenna terminal to measurement instrument via a low loss cable. Then set it to any one measured frequency within its operating range, and make sure the instrument is operated in its linear range.
- c) Set RBW to 100 kHz and VBW of spectrum analyzer to 300 kHz with a convenient frequency span including 100 kHz bandwidth from band edge.
- d) Measure the highest amplitude appearing on spectral display and set it as a reference level. Plot the graph with marking the highest point and edge frequency.
- e) Repeat above procedures until all measured frequencies were complete.

5.8.3 Test Setup

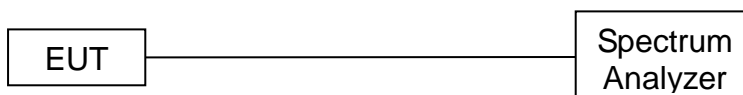

5.8.4 Test Results

| | | | |
|------------|------------------------------|---------------|-----------------------|
| EUT: | Anti-Lost Wireless Powerbank | Model Name: | PB002M |
| Pressure: | 1015 hPa | Test Voltage: | DC 3.87V from battery |
| Test Mode: | TX Mode /CH00, CH39 | | |

BLE 1M: Band Edge, Left Side

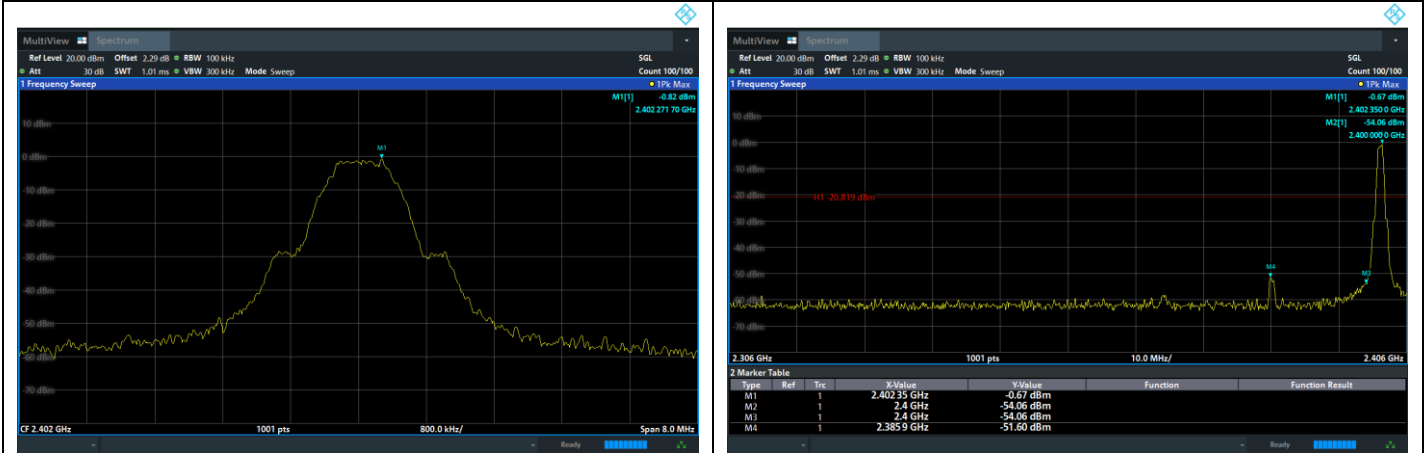

BLE 1M: Band Edge, Right Side



BLE 2M: Band Edge, Left Side

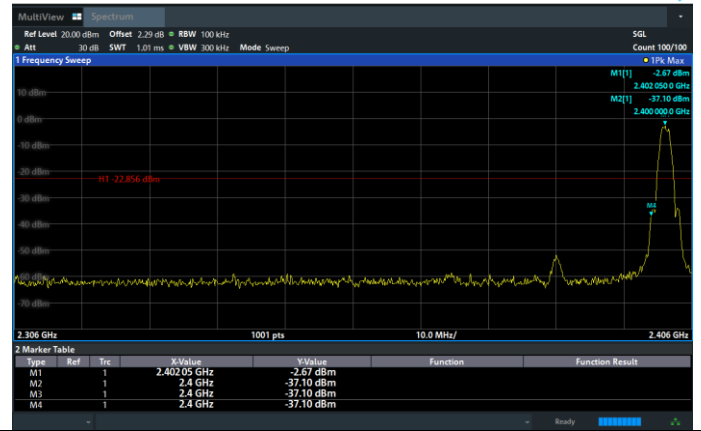
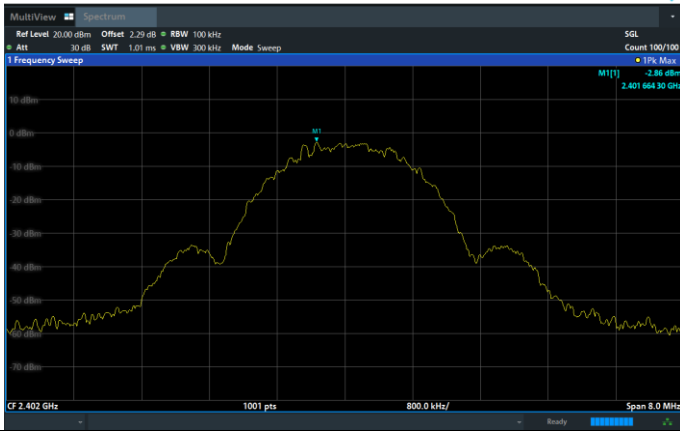

BLE 2M: Band Edge, Right Side

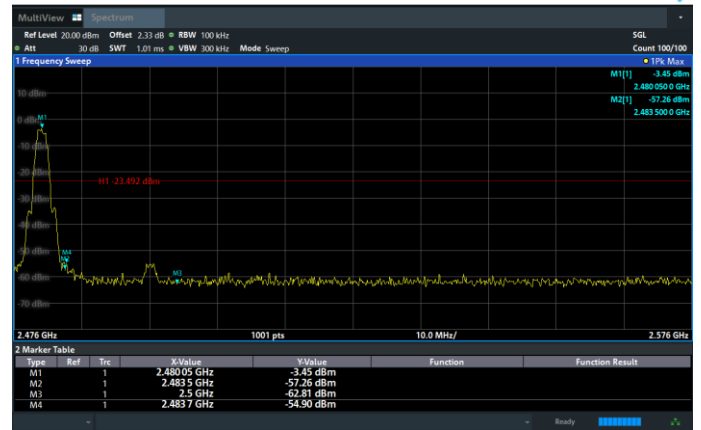
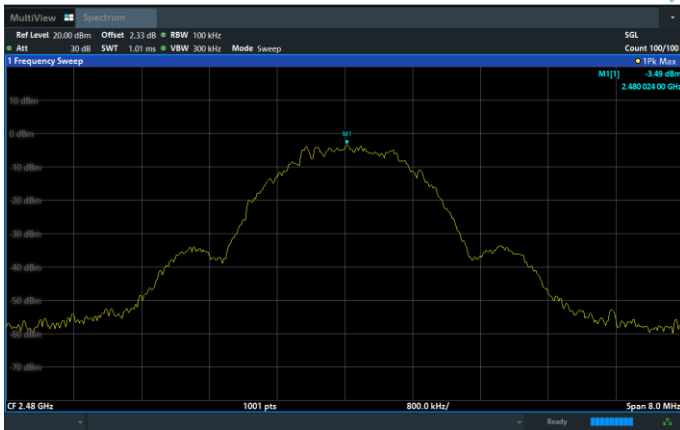

5.9 Spurious RF Conducted Emissions

5.9.1 Limit

Below -20dB of the highest emission level in operating band.

5.9.2 Measuring Instruments

The Measuring equipment is listed in the section 4 of this test report.

5.9.3 Test Procedure

The Spurious RF conducted emissions compliance of RF radiated emission should be measured by following the guidance in ANSI C63.10-2020 with respect to maximizing the emission by rotating the EUT, measuring the emission while the EUT is situated in three orthogonal planes (if appropriate), adjusting the measurement antenna height and polarization etc. Set RBW=100kHz and VBW=300kHz to measure the peak field strength, and measure frequency range from 9kHz to 26.5GHz.

5.9.4 Test Setup

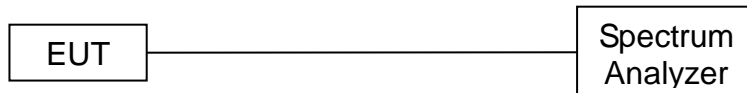

5.9.5 Test Results

Note:

1: The measurement frequency range is from 9kHz to the 10th harmonic of the fundamental frequency. The lowest, middle and highest channels are tested to verify the spurious emissions and band edge measurement data.

2: The worst mode is GFSK mode, and the report only show the worst mode data.

BLE 1M

GFSK on Channel 00

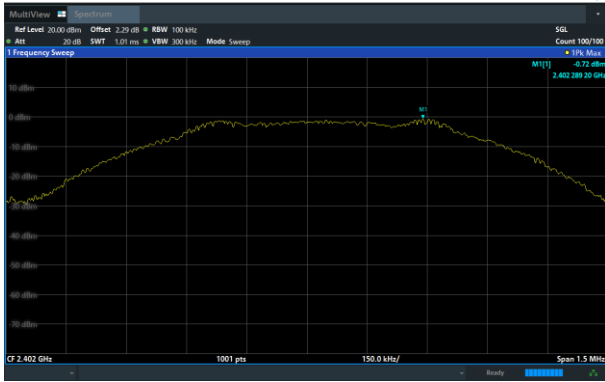

GFSK on Channel 00

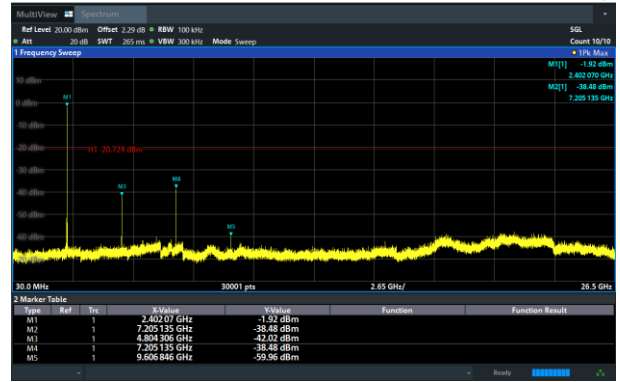

GFSK on Channel 19

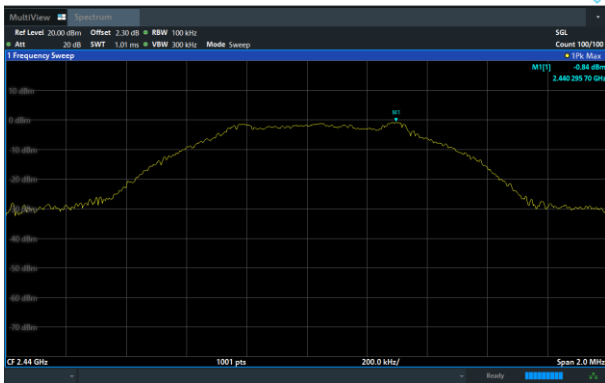

GFSK on Channel 19

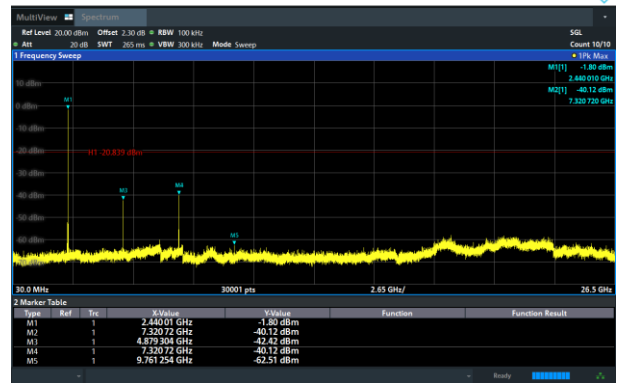

GFSK on Channel 39

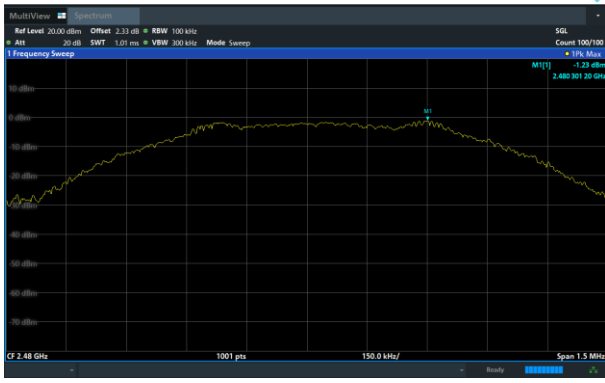

GFSK on Channel 39

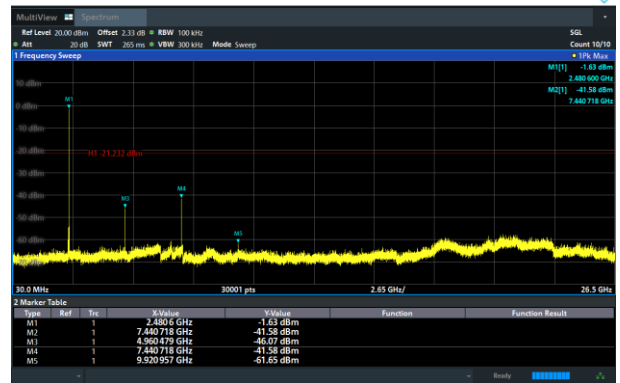

BLE 2M

GFSK on Channel 00



GFSK on Channel 00

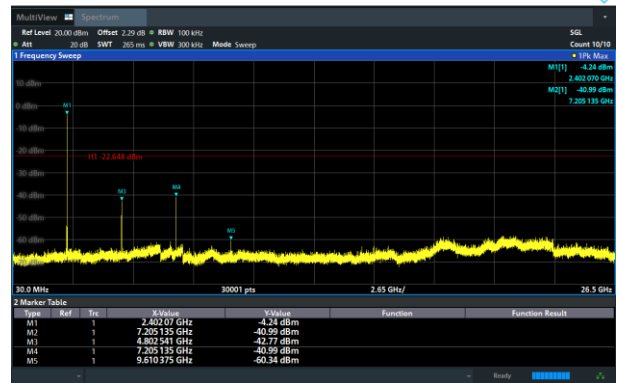

GFSK on Channel 19

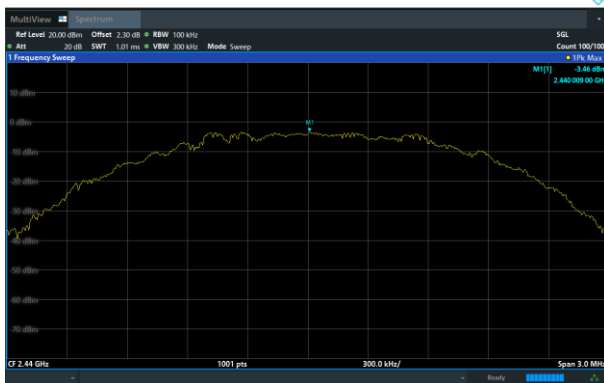

GFSK on Channel 19

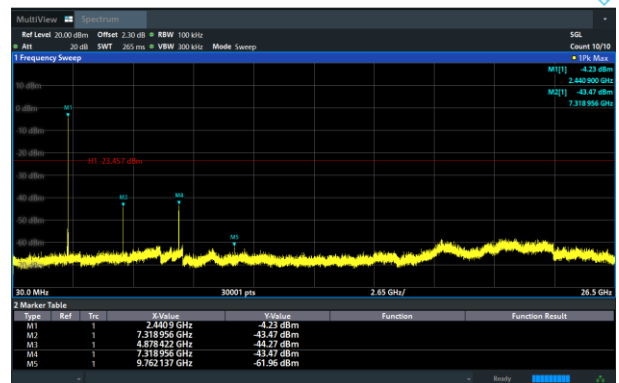

GFSK on Channel 39

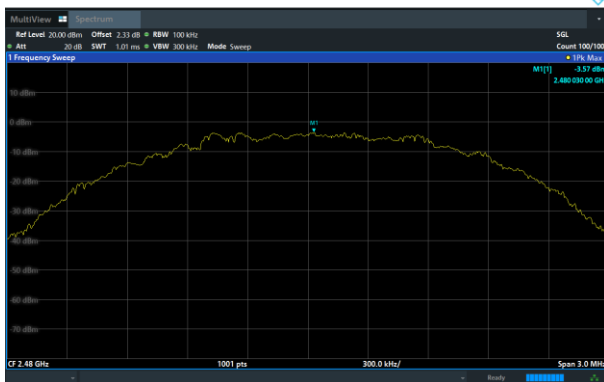

GFSK on Channel 39

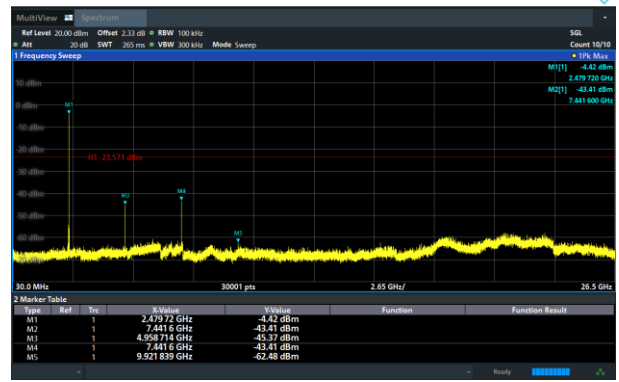

6 Photographs of the Test Setup

Radiated Emission Below 1GHz

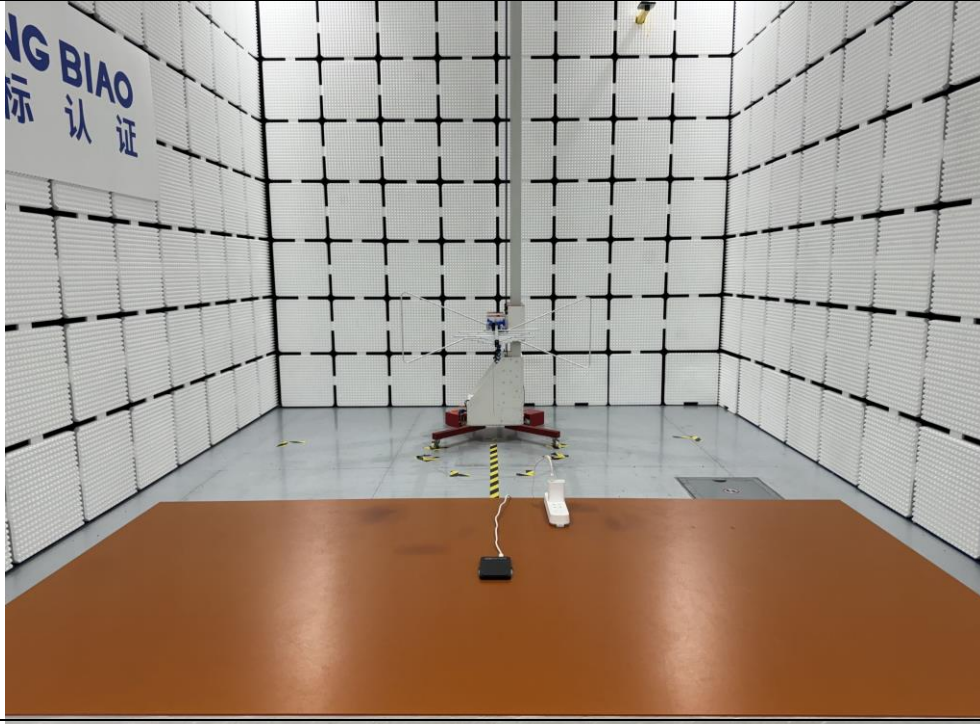

Radiated Emission Above 1GHz



Conducted Emission



7 Photographs of the EUT

Photo 1



Photo 2

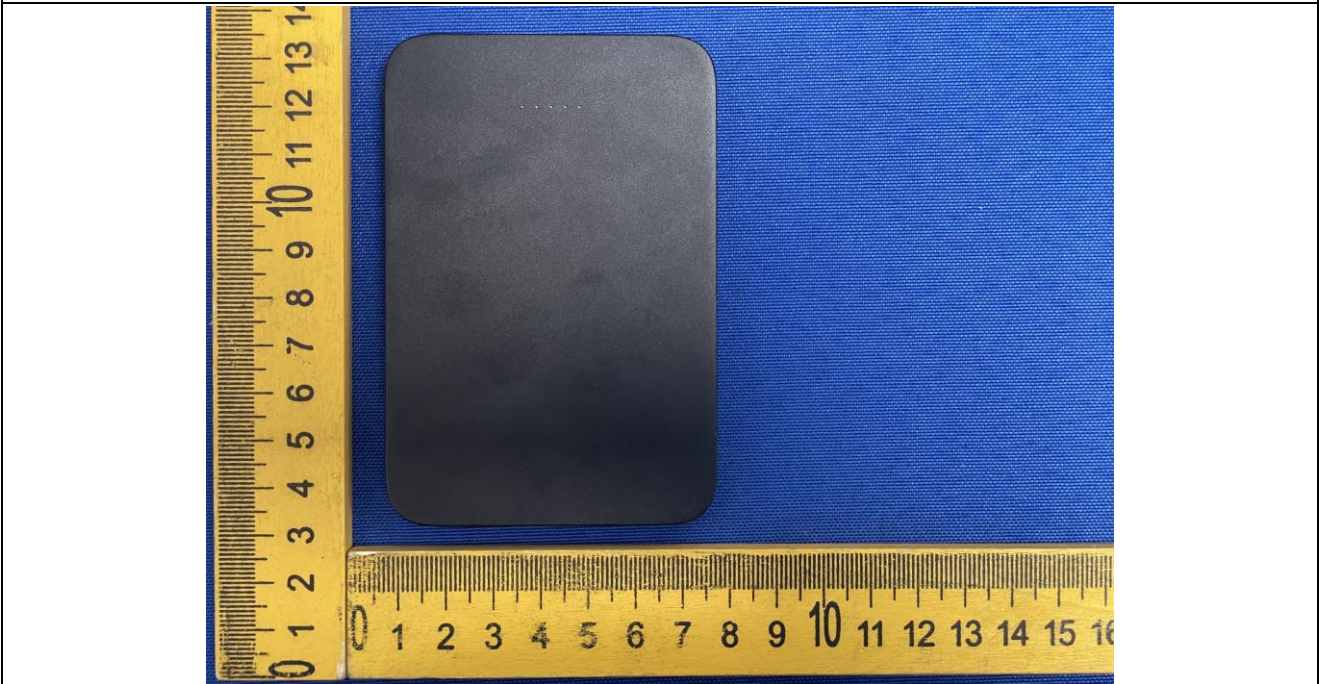

Photo 3



Photo 4



Photo 5



Photo 6



Photo 7

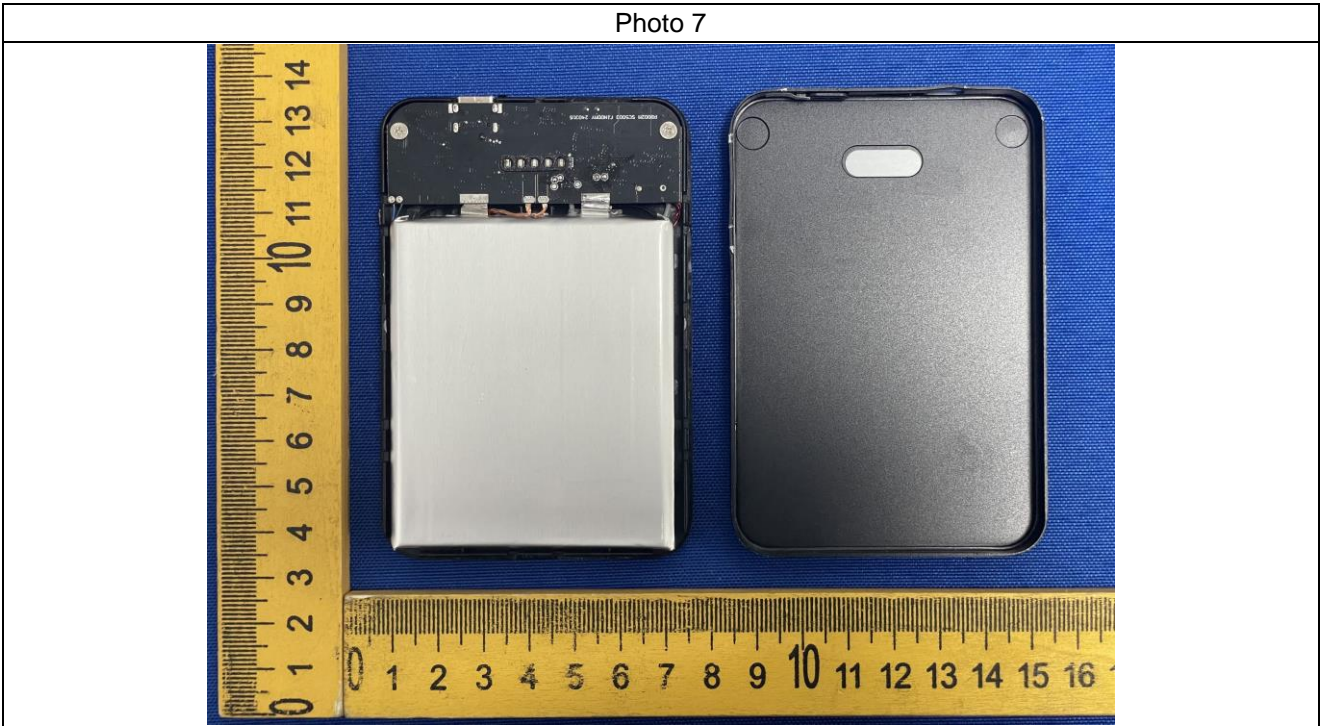

Photo 8

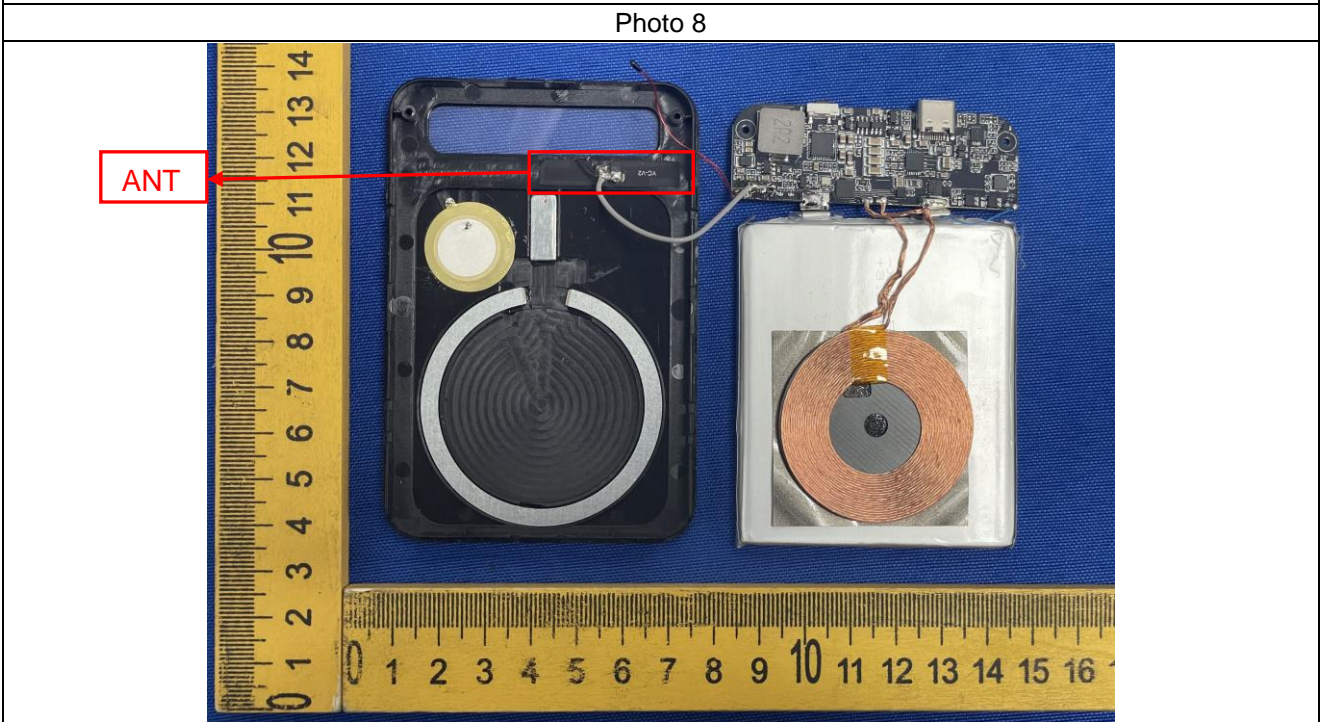

Photo 9



Photo 10

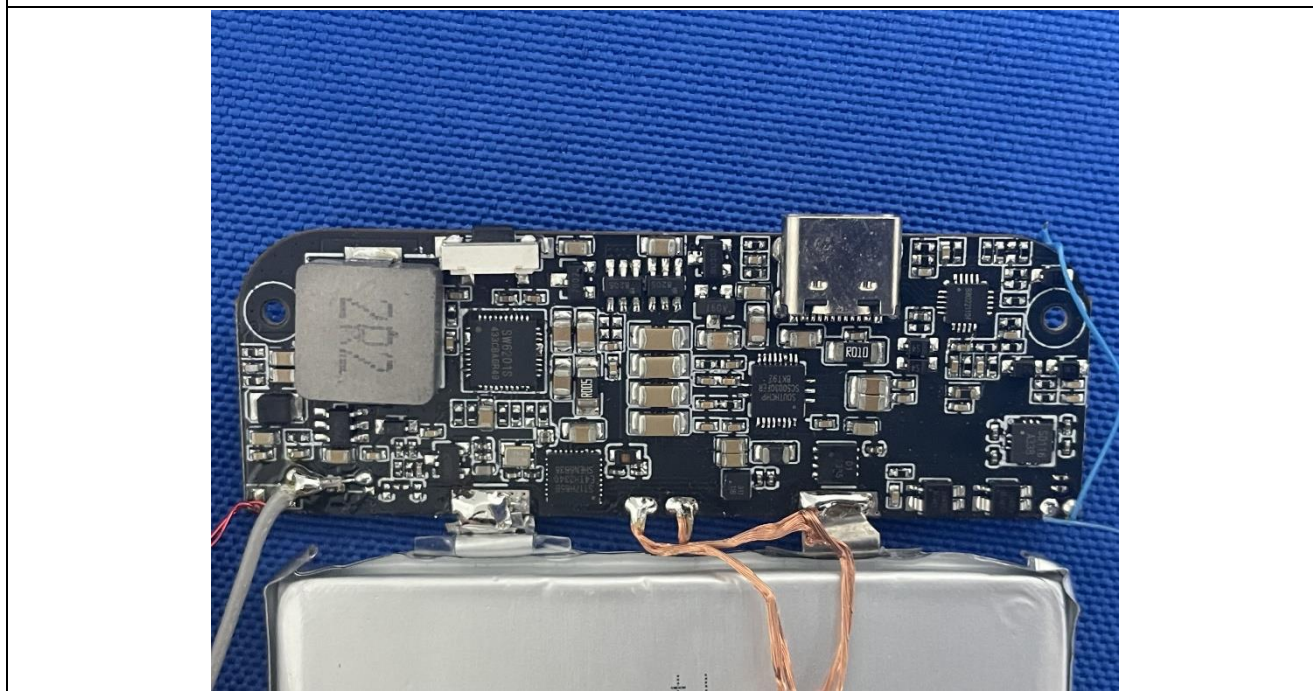

Photo 11

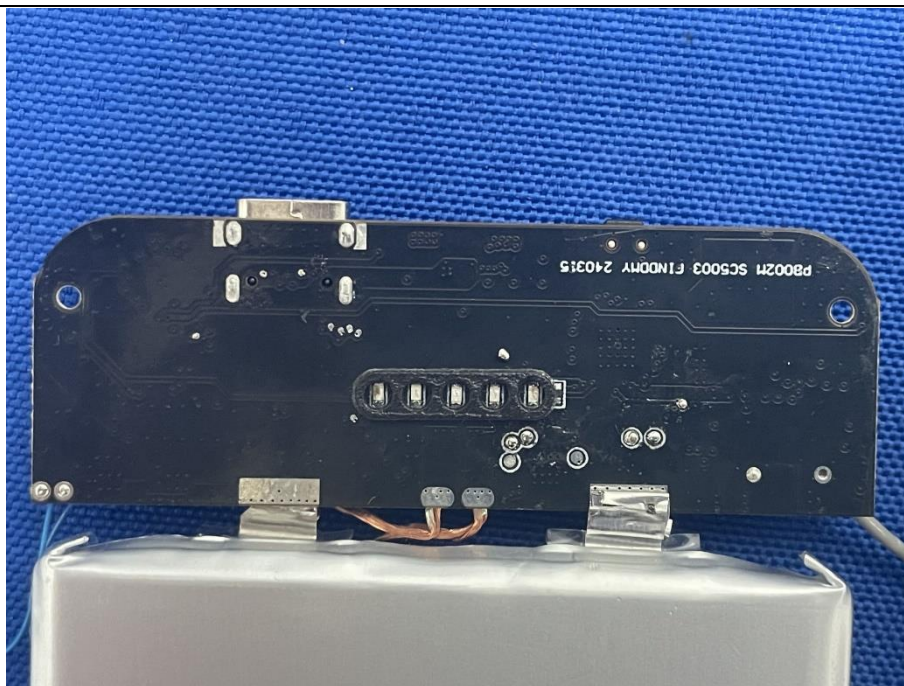
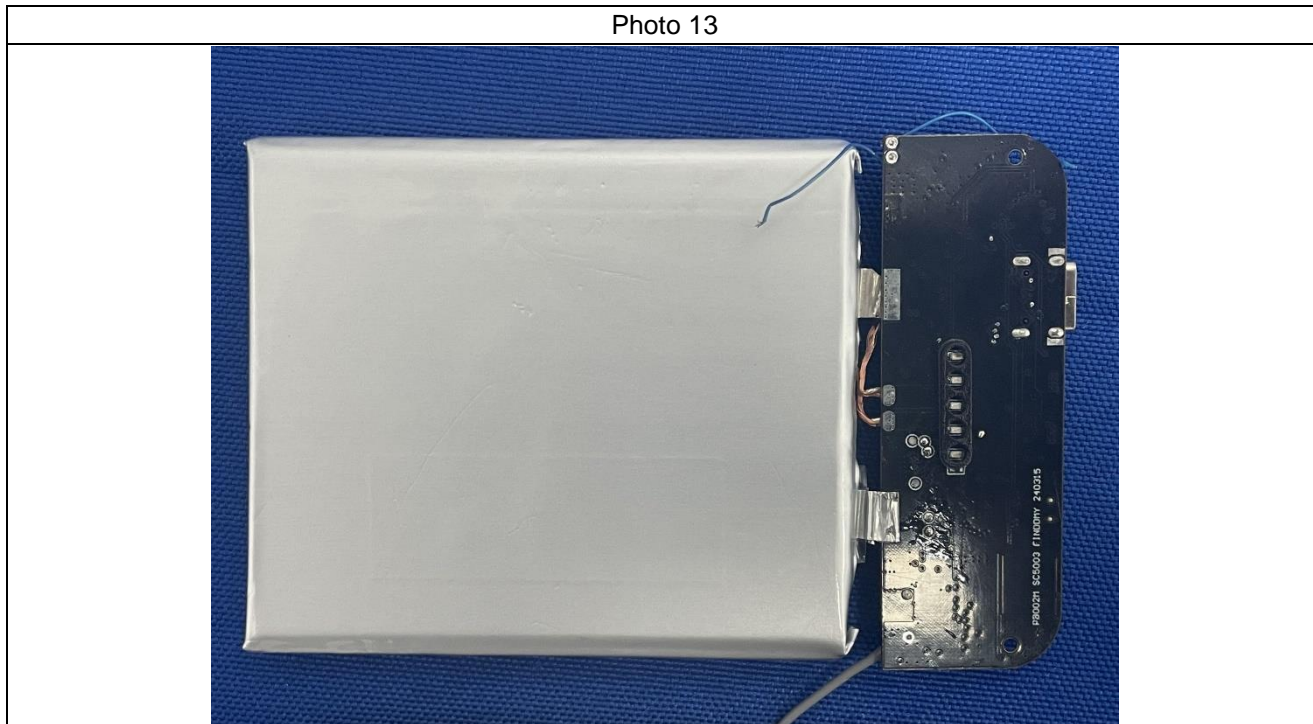

Photo 12



Photo 13



***** END OF REPORT *****