

# momcozy

## VIDEO BABY MONITOR

BM02



## USER GUIDE

4.3" COLOR LCD





**ENGLISH**

# CONTENTS

<b>SAFETY INSTRUCTIONS .....</b>	<b>03</b>
<b>CAUTION .....</b>	<b>03</b>
<b>PACKAGE CONTENTS.....</b>	<b>04</b>
<b>PRODUCT OVERVIEW .....</b>	<b>05</b>
<b>GETTING STARTED .....</b>	<b>08</b>
1. Charging & Powering the Baby Monitor .....	08
2. Powering the Camera .....	08
3. Pairing the Baby Monitor with the Camera.....	08
4. Placing the Camera.....	09
5. Wall Mounting the Camera.....	10
<b>FUNCTIONS &amp; OPERATIONS .....</b>	<b>11</b>
Status Icons.....	11
1. Volume Adjustment.....	12
2. Digital Zoom .....	12
3. Talk Back.....	12
4. Brightness .....	13
5. Screen Sleep.....	13
6. Add a New Camera.....	14
7. Selecting a Camera & Scanning Cameras .....	15
8. Deleting a Camera.....	15
9. Speaker Volume .....	16
10. Alarm Volume .....	16
11. VOX .....	17
12. Alarm Clock .....	17
13. Time .....	18
14. Date .....	18
15. Temperature.....	19
16. Language .....	19
17. Lullabies .....	20
18. Refresh Rate.....	20

19. Factory Settings.....	21
20. Contact Us.....	21
<b>SPECIFICATIONS.....</b>	<b>22</b>
<b>TROUBLESHOOTING.....</b>	<b>24</b>
<b>WARRANTY &amp; CUSTOMER SERVICE.....</b>	<b>25</b>
<b>FCC COMPLIANCE (Camera).....</b>	<b>26</b>
<b>FCC COMPLIANCE (Monitor) .....</b>	<b>27</b>
<b>WEEE COMPLIANCE.....</b>	<b>29</b>

## SAFETY INSTRUCTIONS

- Strangulation Hazard—Children may be STRANGLED by cords. Keep this cord out of the reach of children (more than 3 ft (0.9 m) away). Do not remove this tag.

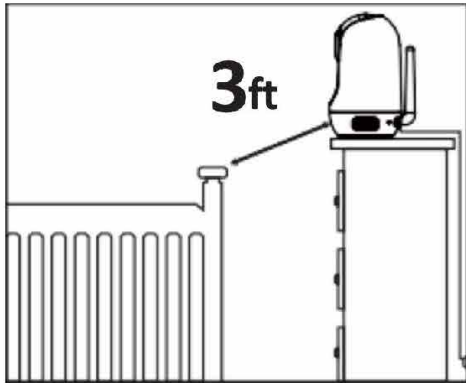

- NEVER place the camera or cord in or near the crib or playpen.
- NEVER mount the camera directly above the crib or playpen to avoid the risk of injury.
- Only use the AC adapters provided.
- Never use the unit near water, including bathtubs, sinks, washing machine hoses, damp basements, etc.
- Do not install near any heat sources such as radiators, heat registers, stoves, or other devices that produce heat.
- Only use attachments and accessories specified by the manufacturer.
- Unplug this device when unused for long periods of time.
- other devices that produce heat.

## CAUTION

- NOT a toy. Do not allow children to play with it.
- This product is NOT intended to replace the proper supervision of children. You MUST regularly check on your child's activities.
- This product is not intended for use as a medical camera and its use should not replace adult supervision.
- Unplug the product during lightning storms.

- Please check the operating range and condition of the camera carefully at the initial installation, and on a regular basis after that.
- Check the status of the interface regularly. Test the camera before use and after changing its location.
- For indoor use only.
- Clean the camera with a dry cloth only.
- Do not block any ventilation openings.
- Microphone feedback might occur when the monitor is too close to the camera. Please keep them at least 1.5 m / 4.9 ft apart.

## PACKAGE CONTENTS



Camera

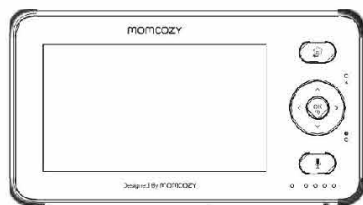

Baby Monitor

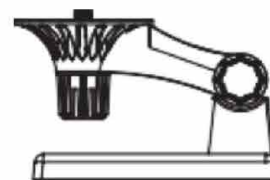

Wall Mount Bracket

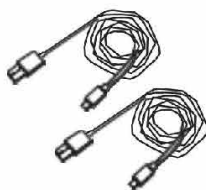

Power Cable \* 2

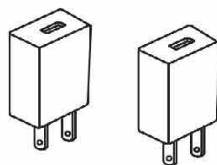

Adapter \* 2

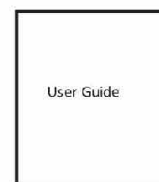

User Guide



Screw \* 2







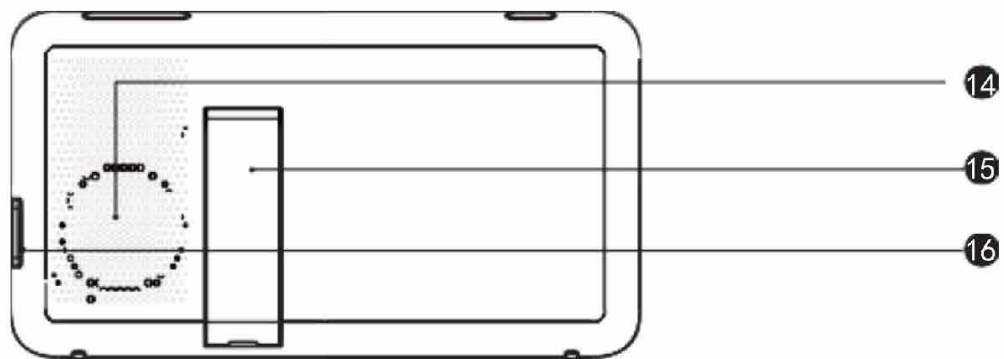
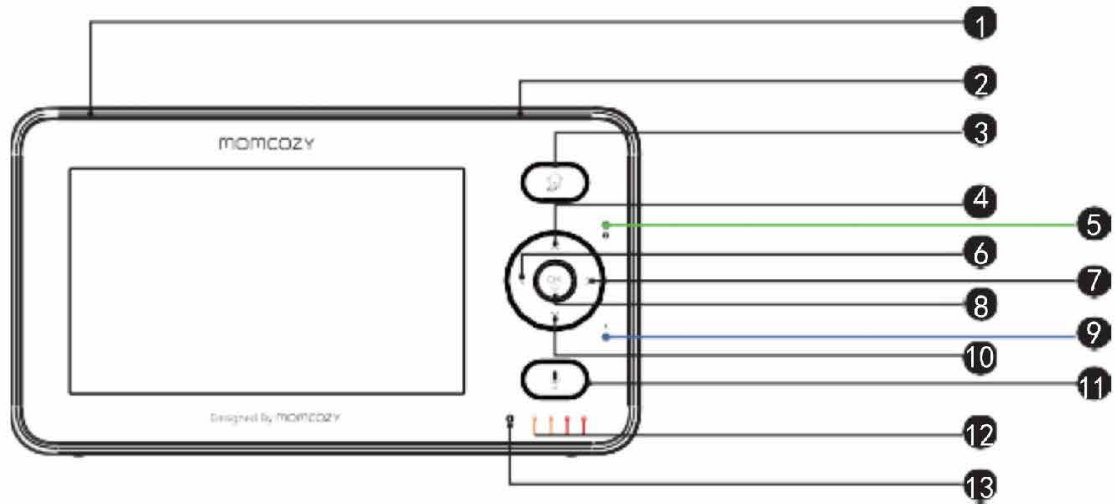

Wall Anchor \* 2

# PRODUCT OVERVIEW

## Monitor





- ① Power On/Off & LCD On/Off: Press and hold for 3 seconds to turn on/off the monitor. Short press to turn on/off the LCD screen.
- ② Volume adjustment: Press the left button to reduce the speaker volume, and press the right button to increase the speaker volume. Menu: Press 
- ③ to enter/exit the menu.
- ④ Up Button: Press  to move the camera upward or to change your selection upward.
- ⑤ Monitoring Status Indicator: Green. When the camera is disconnected, it flashes slowly; when the camera enters pairing mode, it flashes quickly; when the camera is turned on, it remains steady.
- ⑥ Left Button: Press  to move the camera leftward or to change your selection leftward.
- ⑦ Right Button: Press  to move the camera rightward or change your selection rightward.
- ⑧ Confirm/Zoom Button: Press  to zoom in/out to confirm your selection. Charging
- ⑨ Indicator: Solid blue during charging, and goes out when fully charged; Blinking red when the monitor is in a low power state.
- ⑩ Down Button: Press  to move the camera downward or change your selection downward.
- ⑪ Talk: Press  to talk to your baby.
- ⑫ Indicators: 1. The louder the sound received by the monitor, the more indicators will be illuminated. 2. Signal indicator (temperature alarm / off-connection alarm / feeding alarm).
- ⑬ Microphone.
- ⑭ Speaker.
- ⑮ Stand.
- ⑯ Charging Port.

## Camera

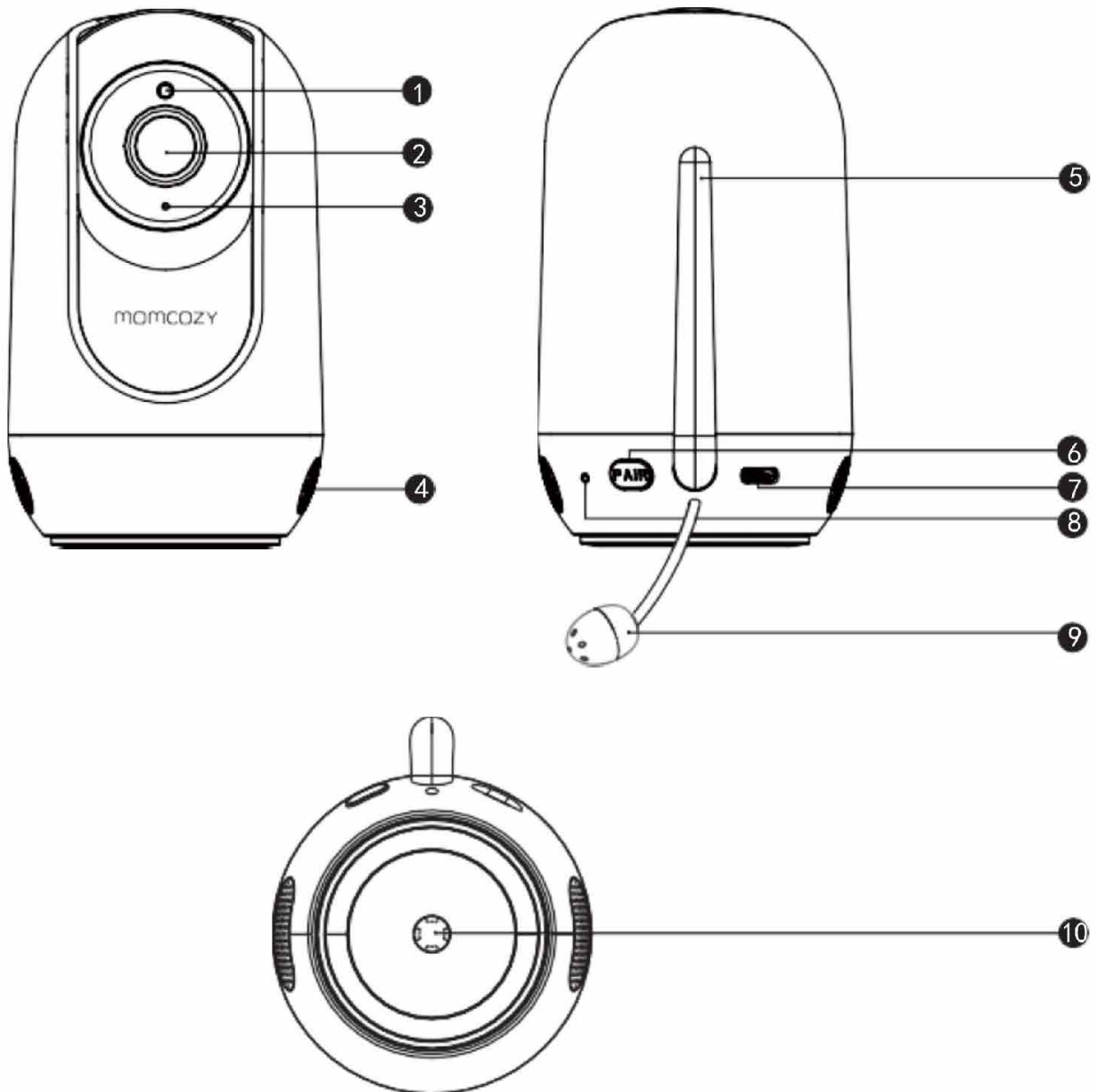

- ① Night Vision Sensor
- ② Camera Lens
- ③ Microphone Speaker
- ④ Antenna

- ⑥ Pair Button Charging
- ⑦ Port Infrared LEDs
- ⑧ Temperature Sensor
- ⑨ Threaded Socket

# GETTING STARTED

## 1. Charging & Powering the Baby Monitor

- 1) Connect the monitor adapter to the monitor and a power outlet.
- 2) Unplug the unit when its power indicator turns off, indicating a full charge.  
Unplug the unit after fully charging the monitor, which can prolong the lifespan of the device.

## 2. Powering the Camera

- 1) Connect the camera to the power source via the USB Type-C cable and camera adapter.



- Only use the power adapters provided.
- Do not place the camera and power cord within the reach of your baby.

## 3. Pairing the Baby Monitor with the Camera

Based on default setting, one camera is paired with the monitor. When you power on the monitor and the camera, the two will automatically pair.

### Adding a new camera to the baby monitor

Step 1:

1. Press to enter menu page.
2. Choose -> button.

Step 2:

1. Select -> -> button.

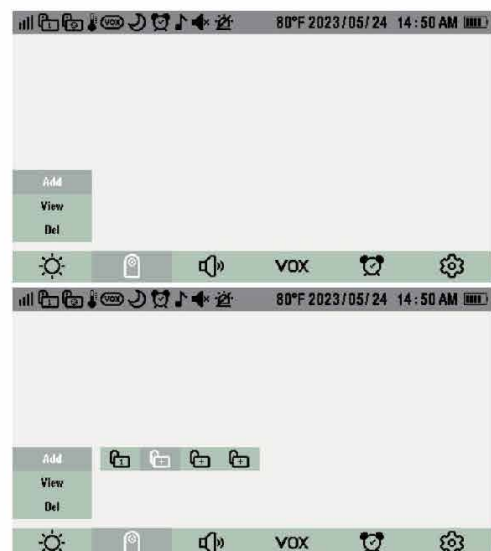

Step 3:

1. Press the PAIR button  on the rear of the camera.
2. Then the monitor will auto-pair with the camera.



- Once they're paired successfully, The camera list  will appear on the screen.
- It is recommended to pair the camera in the baby's room, or wherever you intend to place the camera.
- High-pitched noises might occur when the monitor is too close to the camera. Please keep them at least 1.5 m / 4.9 ft apart.
- The monitor can connect up to 4 cameras at once.

#### 4. Placing the Camera

For safety reasons and better vision in night vision mode, if the camera is placed on a 0.75 m / 2.5 ft table top, the distance from the baby should be at least 1.5 m / 4.9 ft. ( The baby monitor has an infrared night vision capacity up to 6 m / 19.7 ft ). Most importantly, make sure that the camera's power cord is out of your baby's reach.

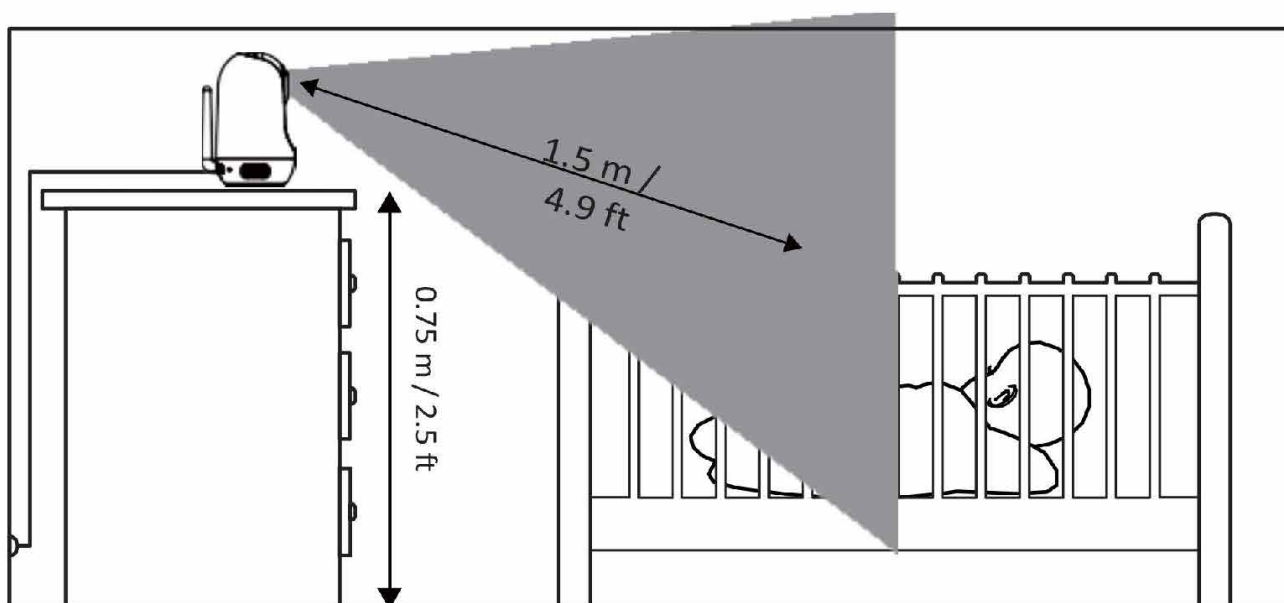

## 5. Wall Mounting the Camera

- 1) Rotate the knob anticlockwise to adjust the wall mount bracket, then fasten the joint and secure the angle.
- 2) Mark the upper and lower holes with a pencil.
- 3) Drill holes in the wall (using a 17 / 64 inch drill bit) and insert wall anchors into holes with a hammer.
- 4) Fasten the wall mount bracket using screws.
- 5) Place the camera on the wall mount bracket. Tighten the screw into the threaded socket at the bottom to secure the camera.
- 6) You can maximize your camera unit's viewing angles by tilting the wall mount bracket. Tilt your camera up or down to adjust to your preferred angle.

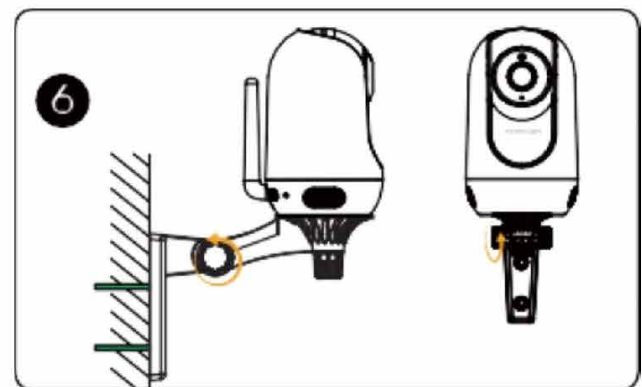
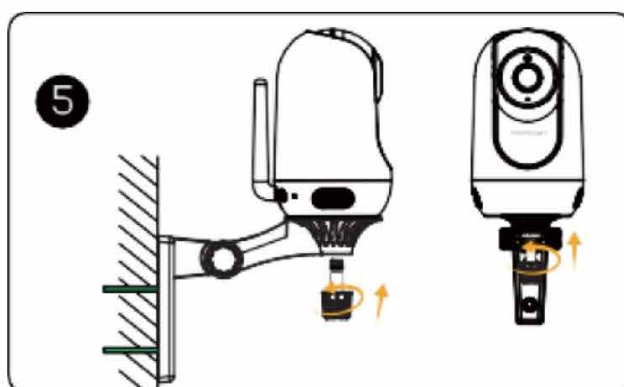
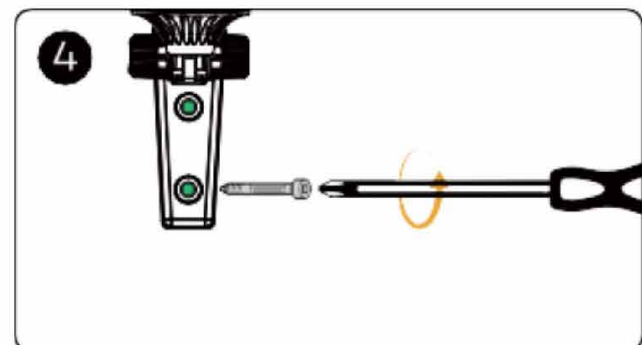
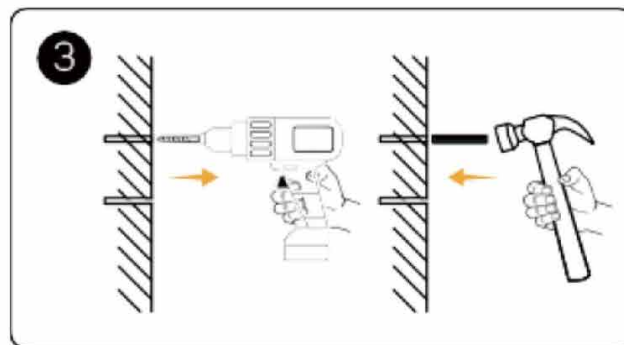
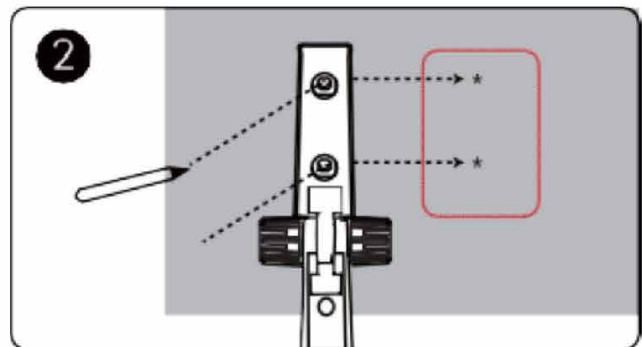
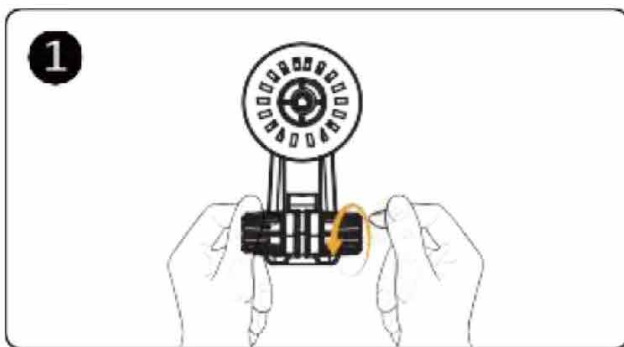















• Don't release the camera until it is firmly mounted.



# FUNCTIONS & OPERATIONS

## Status Icons

	No Signal
	Signal Strength
	Cycle Cameras Enabled (switches every 10 seconds)
	The First Connected Camera
	The Second Connected Camera
	The Third Connected Camera
	The Fourth Connected Camera
12:08	Current Time
	Lullabies Enabled
	VOX Function On
	Temperature Alarm
	Feeding Reminder
	Volume Mute
	Night Vision Mode
°C / °F	Current Room Temperature
	Battery Level
	Alarm Mute

# 1. Volume Adjustment

## Using the Shortcut Button :

Press  Button ->Left/Right button to quickly adjust the volume.

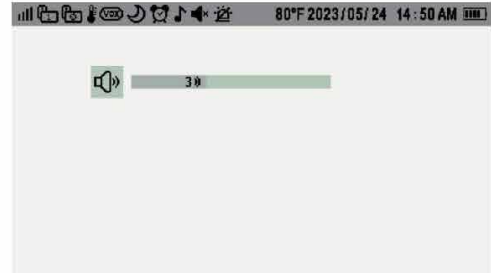



• To adjust system sound, navigate to Monitor volume.



-> Alarm



# 2. Digital Zoom

Press the  button to zoom in the screen to 2X and 4X respectively in camera viewing mode. Press the  button for the third time to adjust the zoom setting back to default.

# 3. Talk Back

Press and hold the  Button to talk to your baby, release it to exit the talking mode.





- When you are in the monitoring mode, press and hold the  button to enter the intercom mode, and the  icon will be displayed on the monitor. When you enter the menu, the intercom function can still be used.
- When it's muted or the speaker volume is too low, you may not be able to hear the baby.
- When you're pressing the  Button, the camera will not transfer the sound to the monitor. Please release the button to listen to your baby.

## 4. Brightness

### Explanation:

This function is used to adjust the screen brightness of the monitor.

#### Step 1:

1. Press  to enter menu page.
2. Choose  ->  button.

#### Step 2:

1. Select the **Brightness** Setting to change the monitor screen brightness.

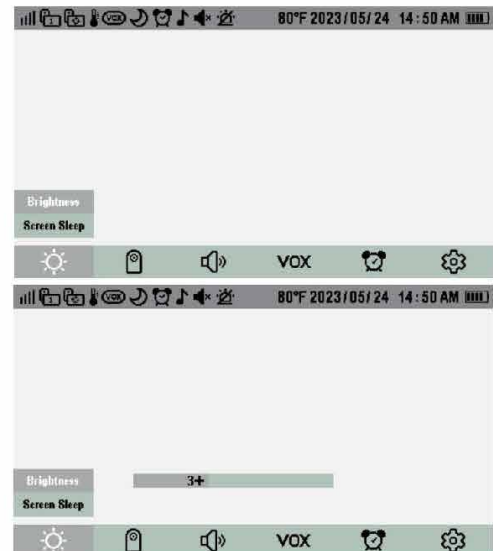



## 5. Screen Sleep

### Explanation:

This function puts the monitor screen to sleep without powering off the monitor.

#### Step 1:

1. Press  to enter menu page.
2. Choose  ->  button.

#### Step 2:

1. Select **Screen Sleep** and select the time you want.

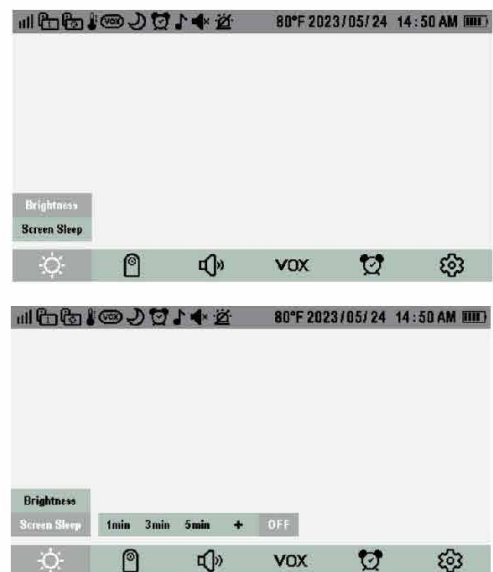









- Click **+** to enter the page for custom sleep time. The resting time ranges from 1 to 60 minutes.
- The screen will automatically light up if there is a VOX or a temperature alert.
- When VOX is turned off, the screen will not automatically wake up and light up.
- When the sleep time is set to " **OFF** ", the monitor will not turn off.

## 6. Add a New Camera

Step 1:

1. Press  to enter menu page.
2. Choose  ->  button.

Step 2:

1. Select **Add** ->  ->  button.

Step 3:

1. Press the PAIR button  on the rear of the camera.
2. Then the monitor will show the camera is paired successfully.

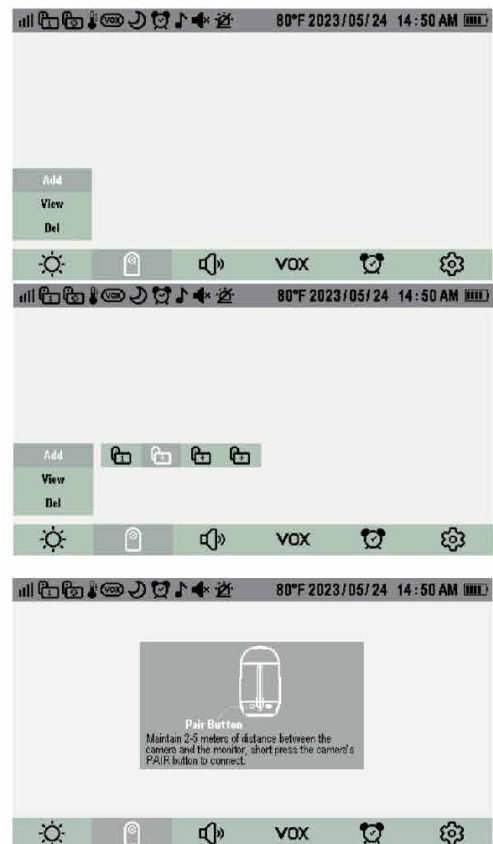

- The monitor can connect up to 4 cameras at once.

## 7. Selecting a Camera & Scanning Cameras

### Note:

This function requires more than two cameras to be turned on.

Multiple cameras should be powered on and within the monitor connection range.



### Step 1:

1. Press  to enter menu page.
2. Select  -> **View**  
->  button.

### Step 2:

1. Select the camera you want to switch and press the  button.

### Step 3:

1. If you need to cycle through multiple camera views.  
Select  ->  button.



## 8. Deleting a Camera

### Step 1:

1. Press  to enter menu page.
2. Select  -> **Del**  
->  button.

### Step 2:

1. Select the camera you want to delete and press the  button.

### Step 3:

1. Select **YES**. The camera is deleted successfully.

