



Shenzhen Jiashengjia Technology Co., LTD

Add: Room 101, Building B, Nanhu Industrial Zone, No.58 Dongchang Road,
Dongxiao Community, Dongxiao Street, Luohu District, Shenzhen



Date : 2023.9.2

Antenna matching

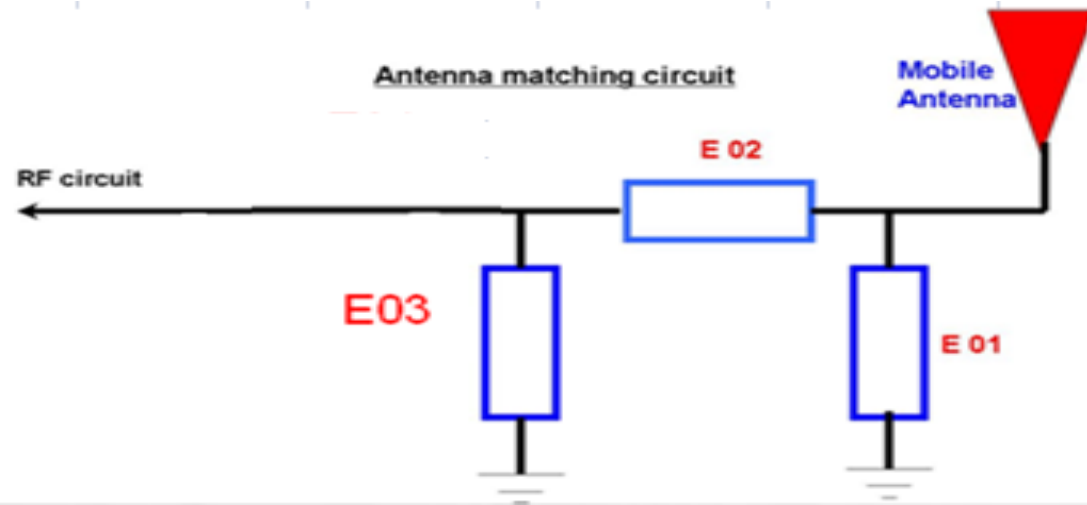

E01	
E02	
E03	

Passive efficiency diagram

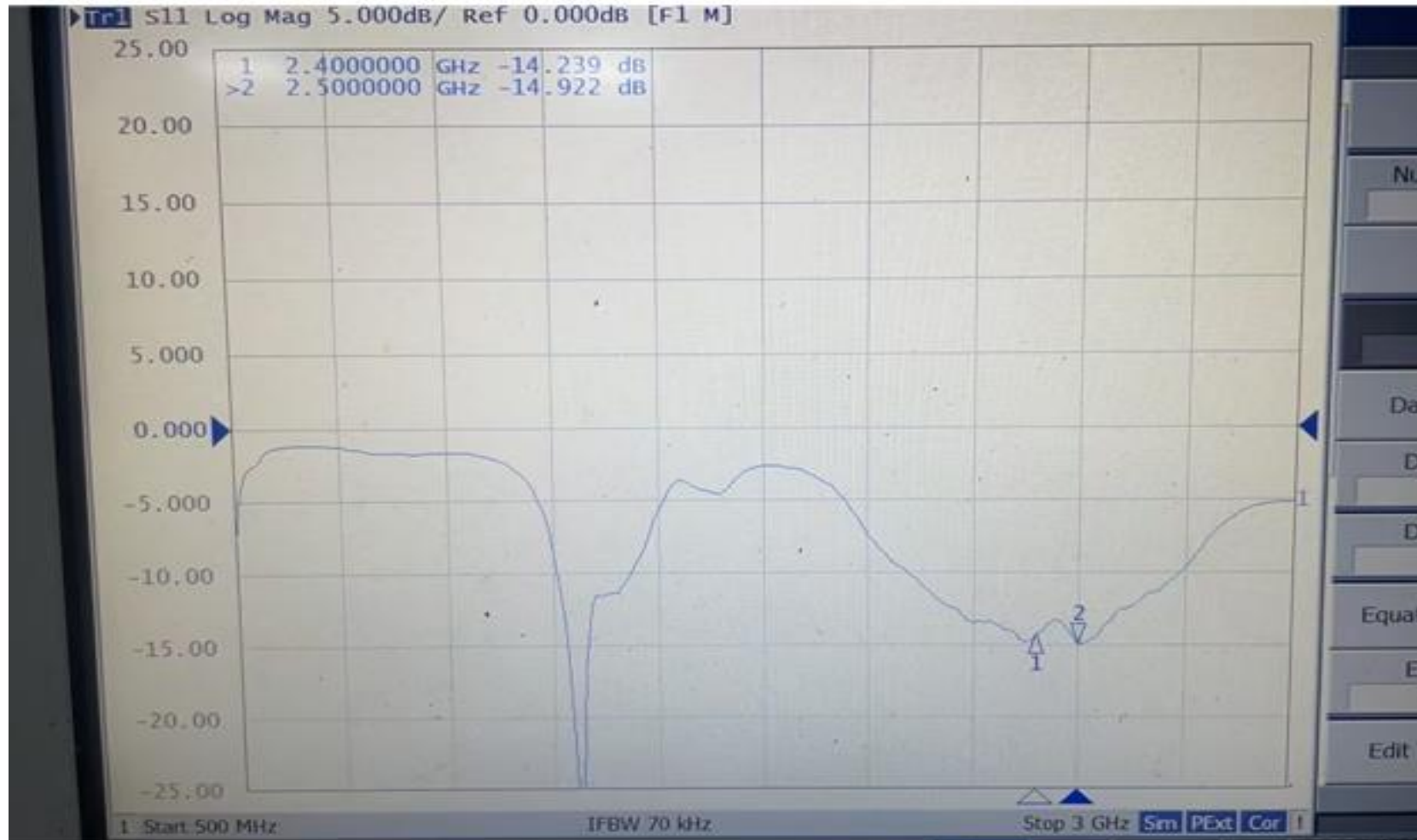

Passive efficiency diagram

频点	效率 (db)	效率 (%)	Gain
2400	-2.86	45.93	0.95
2410	-2.53	46.98	1.49
2420	-2.21	47.79	1.83
2430	-1.97	48.15	2.13
2440	-1.61	49.89	2.45
2450	-1.26	50.39	2.68
2460	-1.56	49.05	2.27
2470	-1.77	48.29	1.99
2480	-1.85	47.13	1.48
2490	-2.01	46.4	1.24
2500	-2.61	45.93	1.01

2D.3D

Data3D | Data List | Analysis | Template

Frequency: 2400

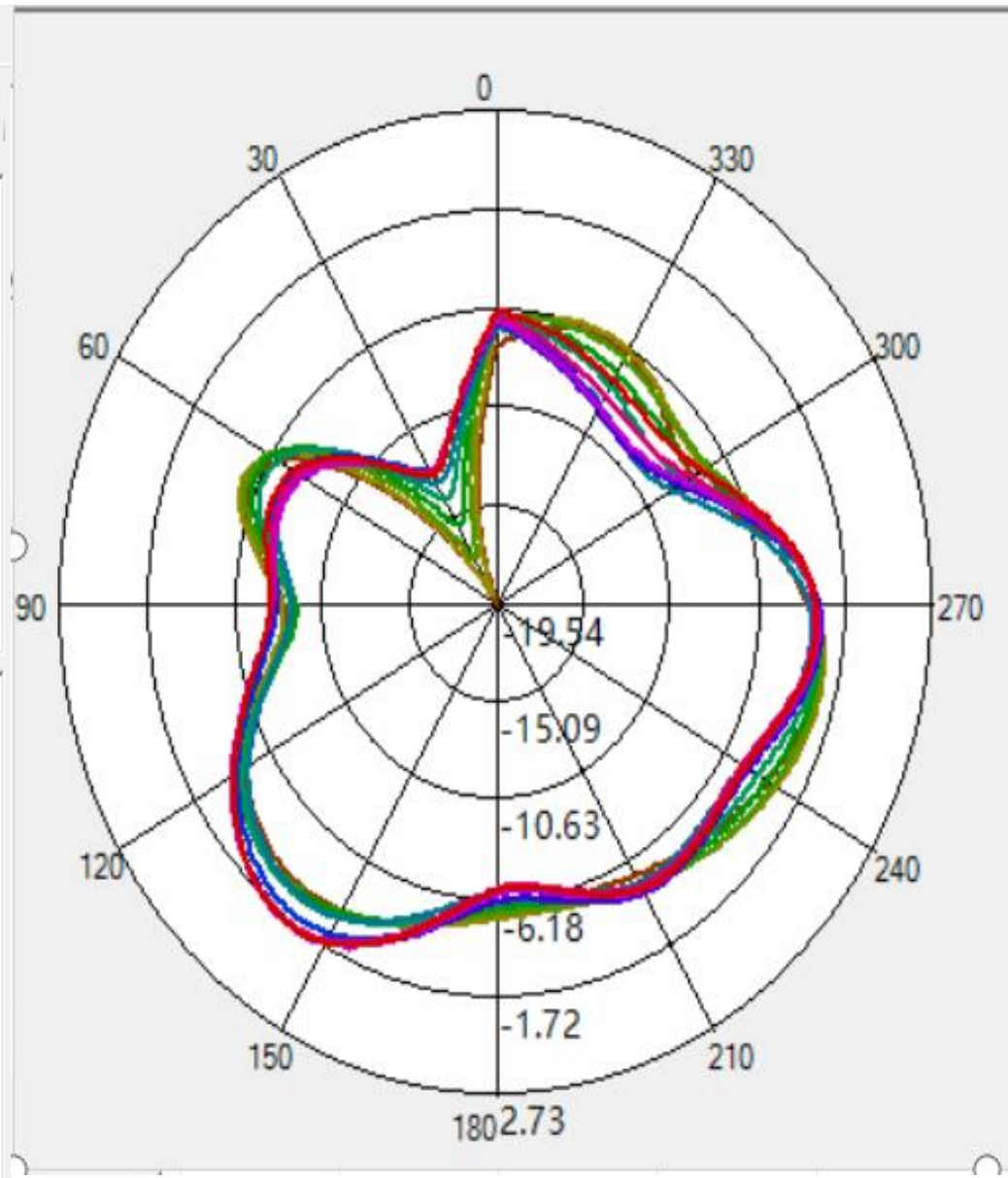
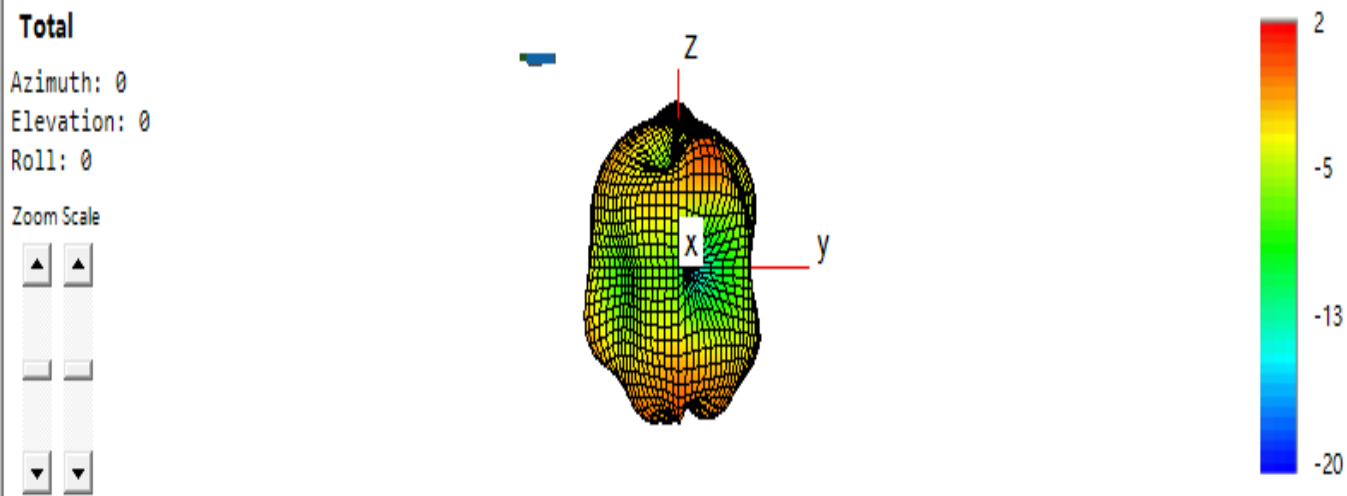
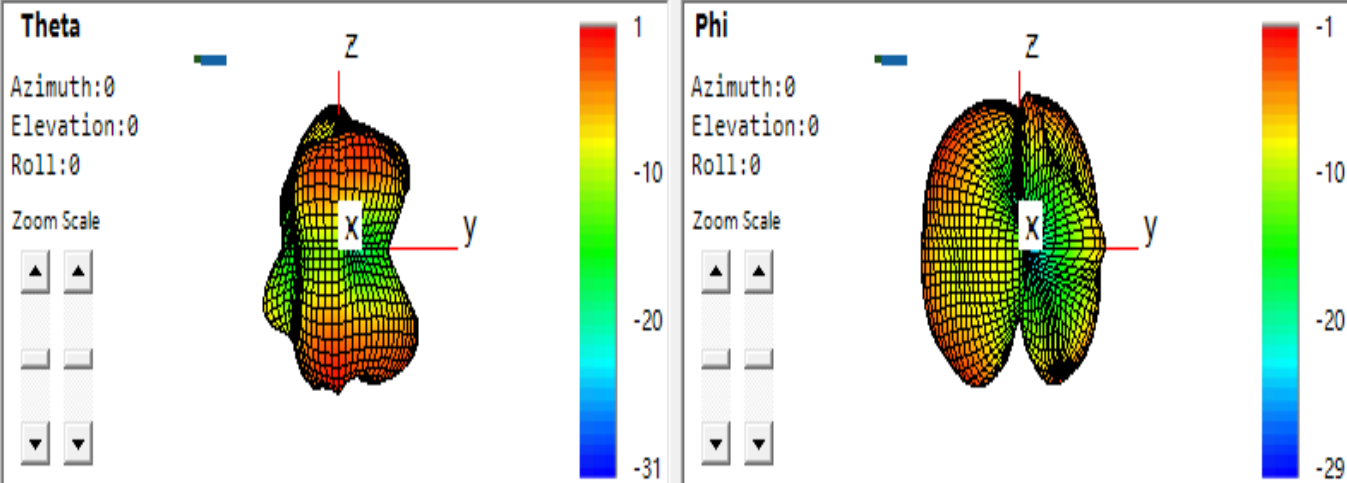

Frequency: 2440

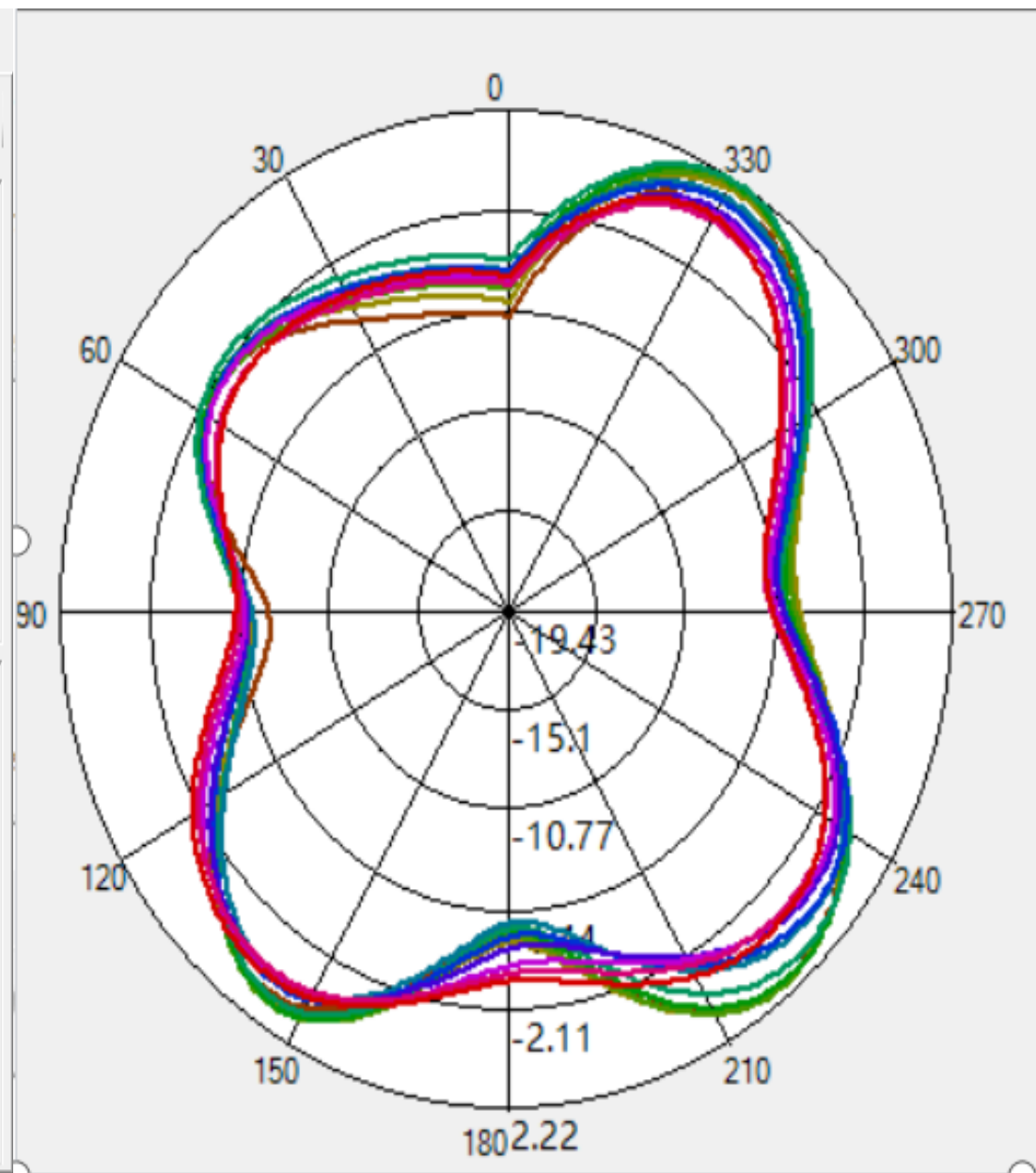
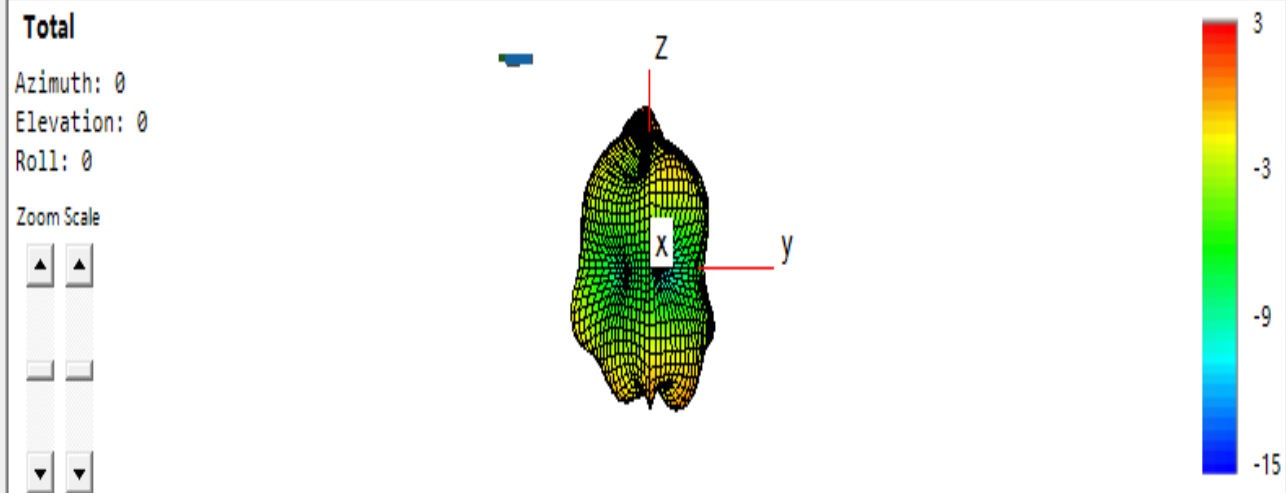
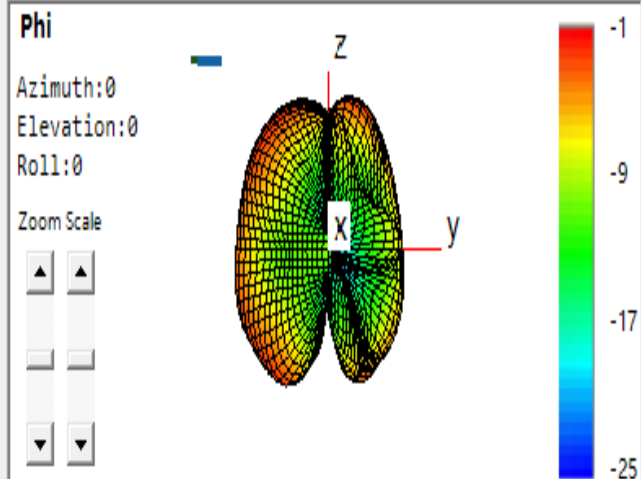
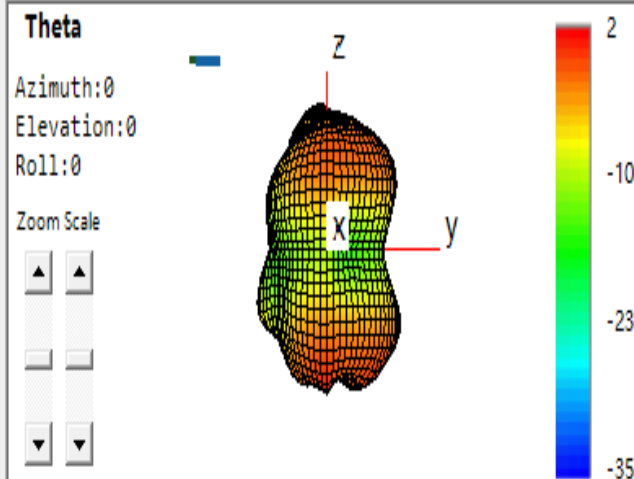

Frequency: 2480

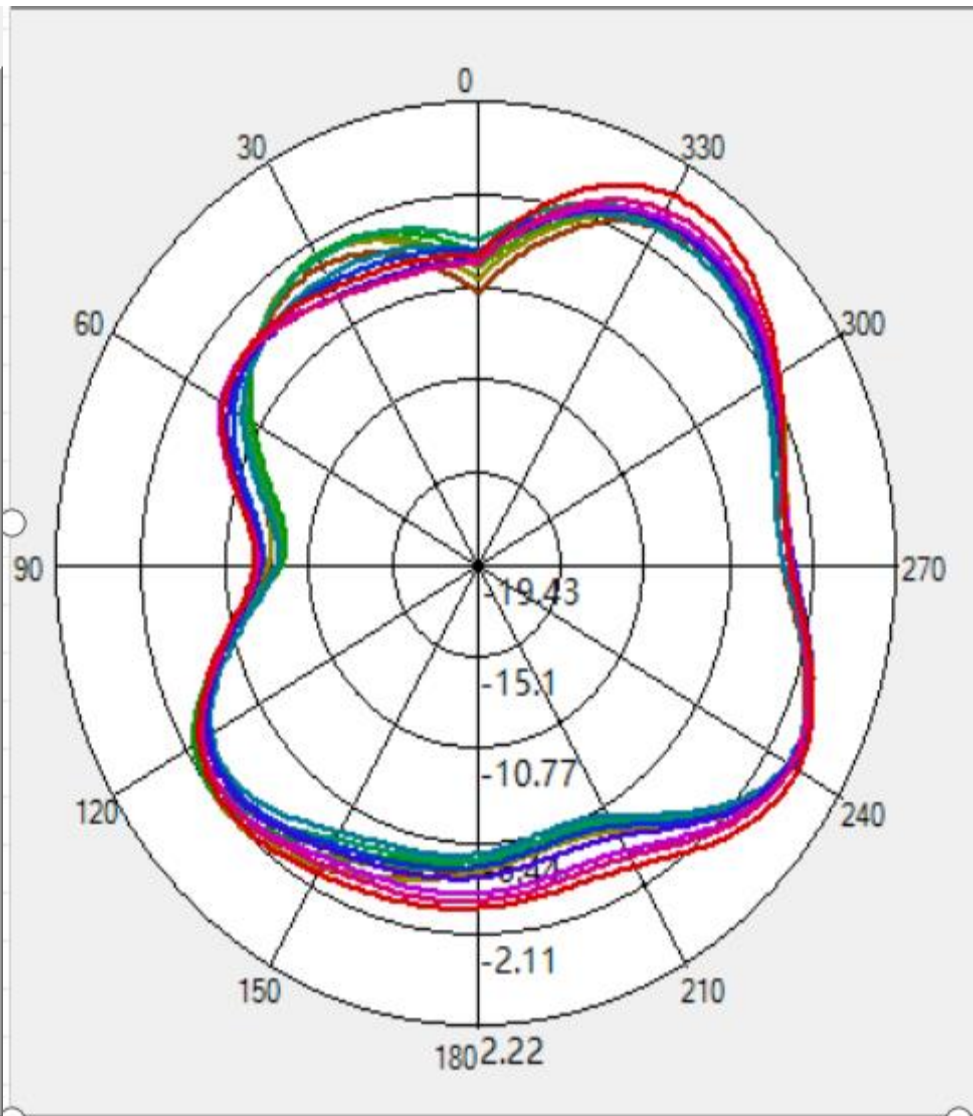
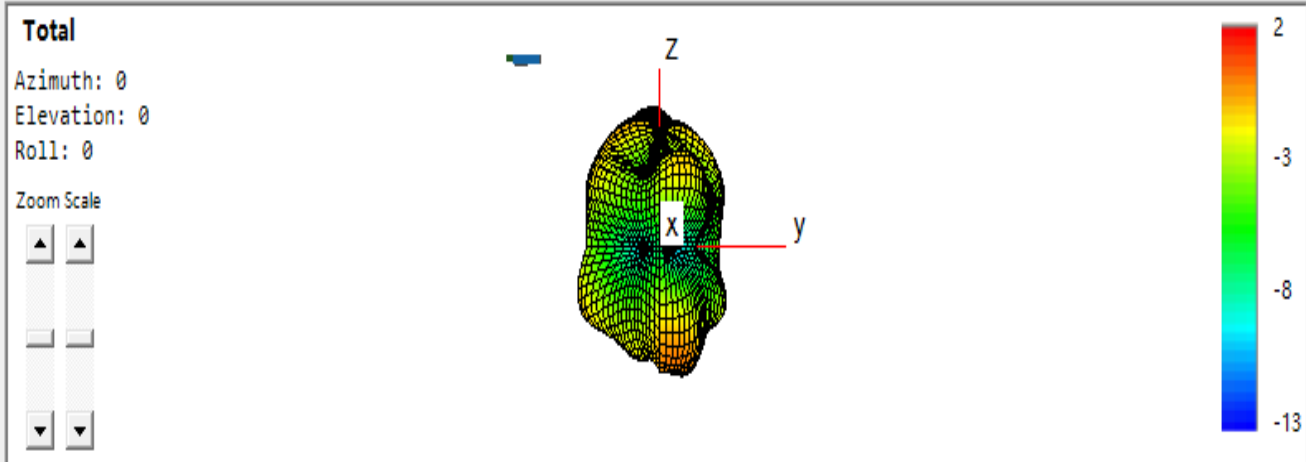
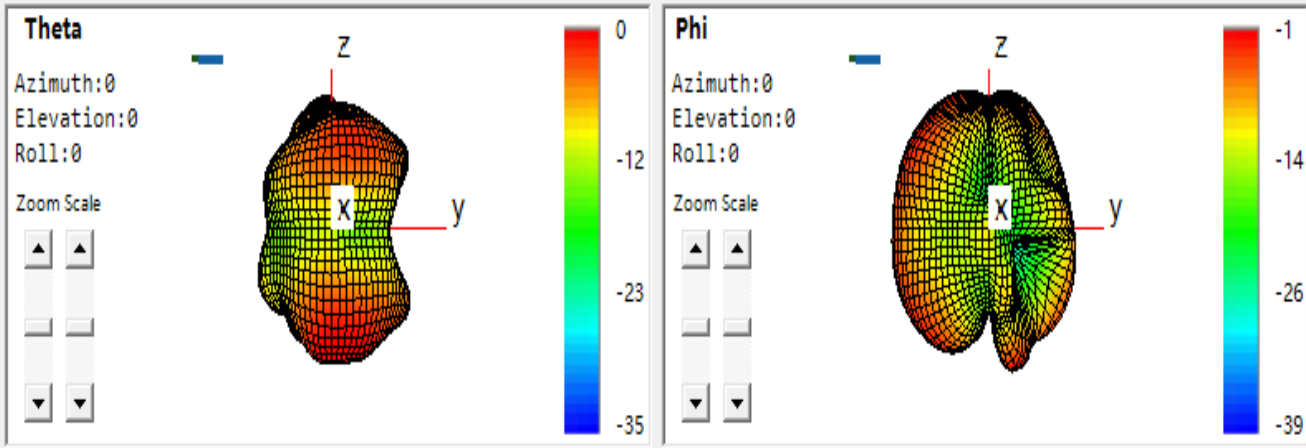

Assembly drawing



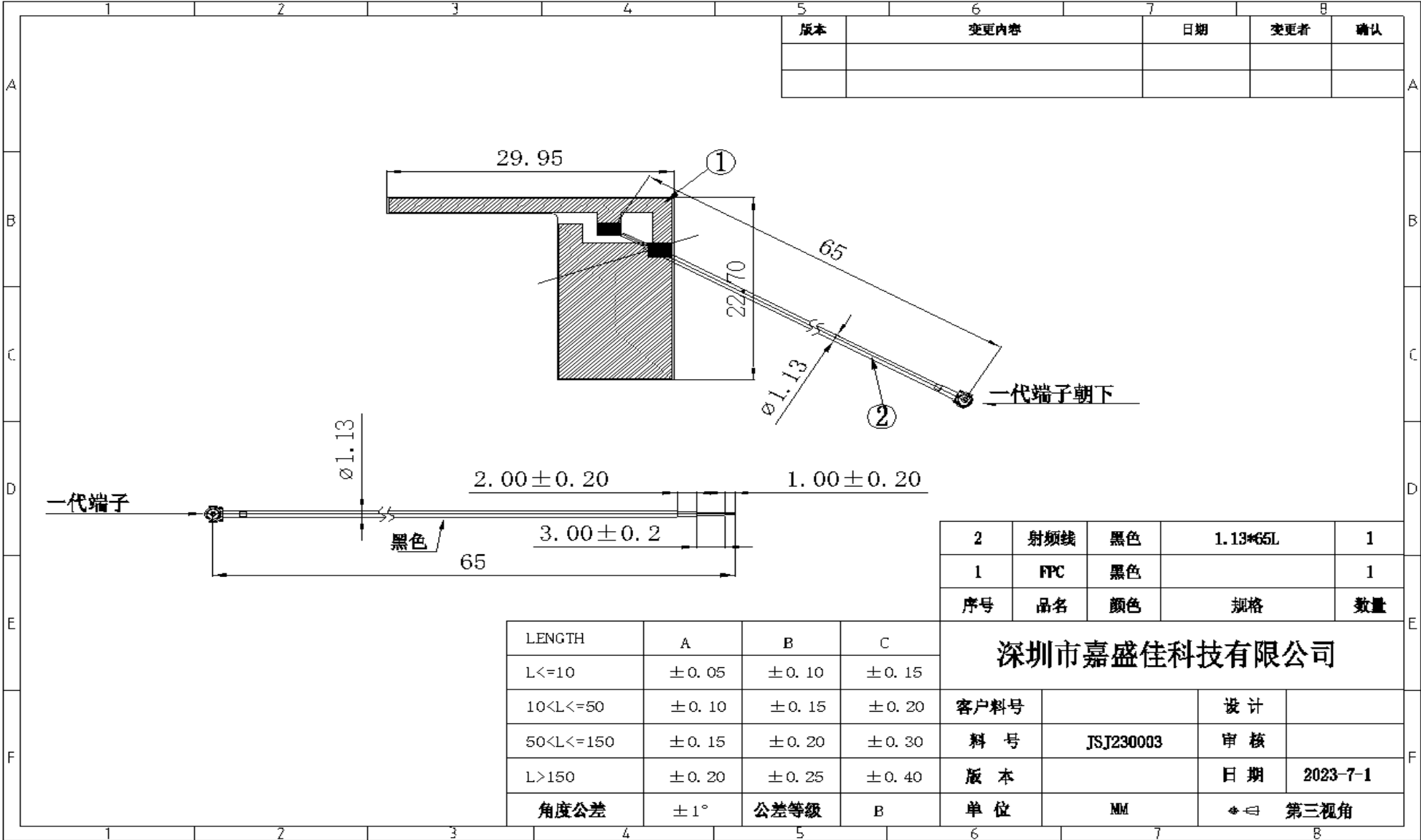

版本	变更内容	日期	变更者	确认

序号	品名	颜色	规格	数量
2	射频线	黑色	1.13*65L	1
1	FPC	黑色		1

LENGTH	A	B	C	深圳市嘉盛佳科技有限公司			
L ≤ 10	± 0.05	± 0.10	± 0.15	客户料号		设计	
10 < L ≤ 50	± 0.10	± 0.15	± 0.20	料号	JSJ230003	审核	
50 < L ≤ 150	± 0.15	± 0.20	± 0.30	版本		日期	2023-7-1
L > 150	± 0.20	± 0.25	± 0.40	单位	MM	第三视角	
角度公差	± 1°	公差等级	B				

THANK YOU

