



# Shenzhen Jiashengjia Technology Co., LTD

Add: Room 101, Building B, Nanhu Industrial Zone, No.58 Dongchang Road,  
Dongxiao Community, Dongxiao Street, Luohu District, Shenzhen



Date : 2023.10.27

# Antenna matching

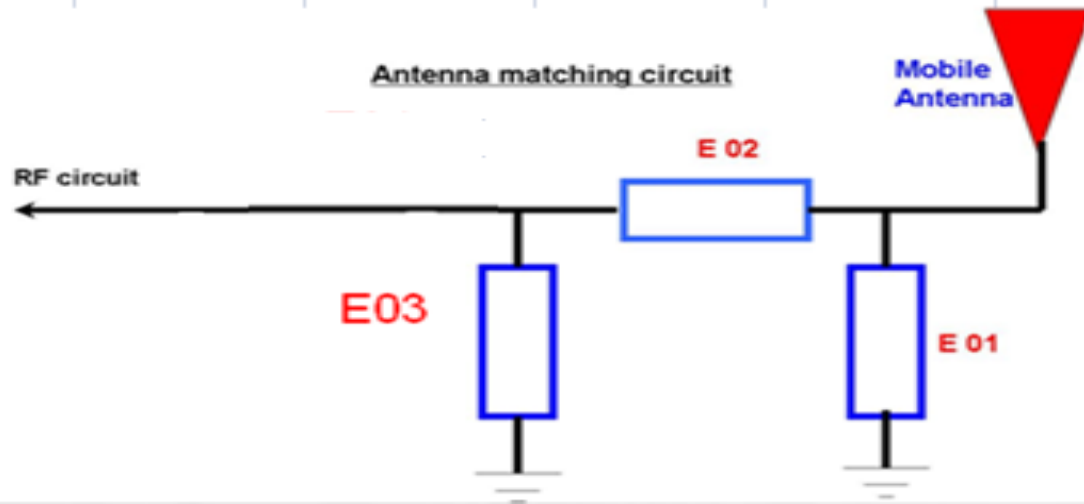

E01	
E02	
E03	

# Passive efficiency diagram

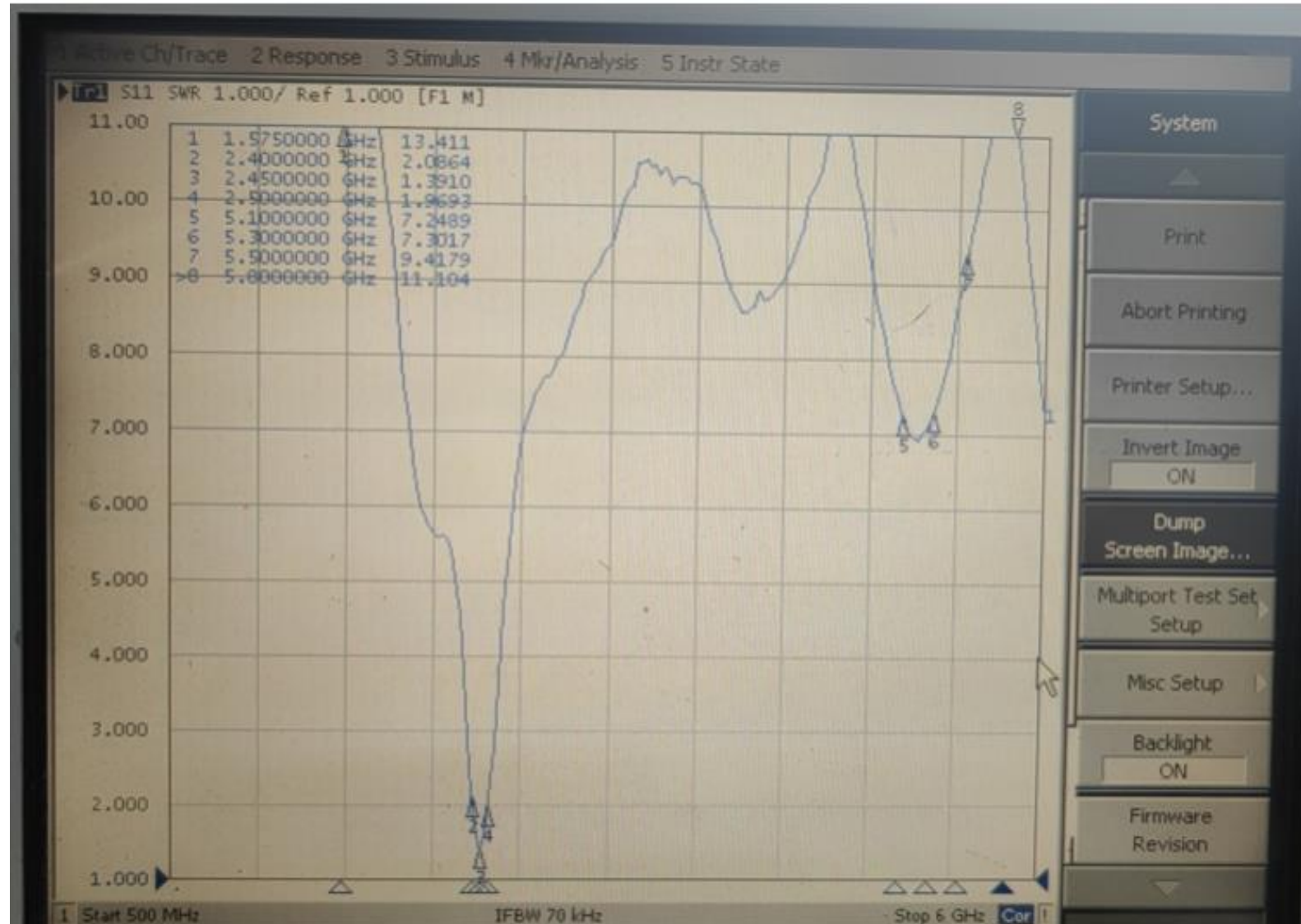

# Passive efficiency diagram

频点	效率 (db)	效率 (%)	Gain
2400	-2.47	56.66	1.76
2410	-2.07	62.15	2.06
2420	-2.04	62.48	2.01
2430	-2.01	62.88	2.25
2440	-2	63.16	2.41
2450	-2.57	55.38	1.86
2460	-2.52	55.96	2.12
2470	-2.87	51.62	1.92
2480	-3.01	50.04	2.02
2490	-3.26	47.26	2.14
2500	-3.12	48.74	2.74

# 2D.3D

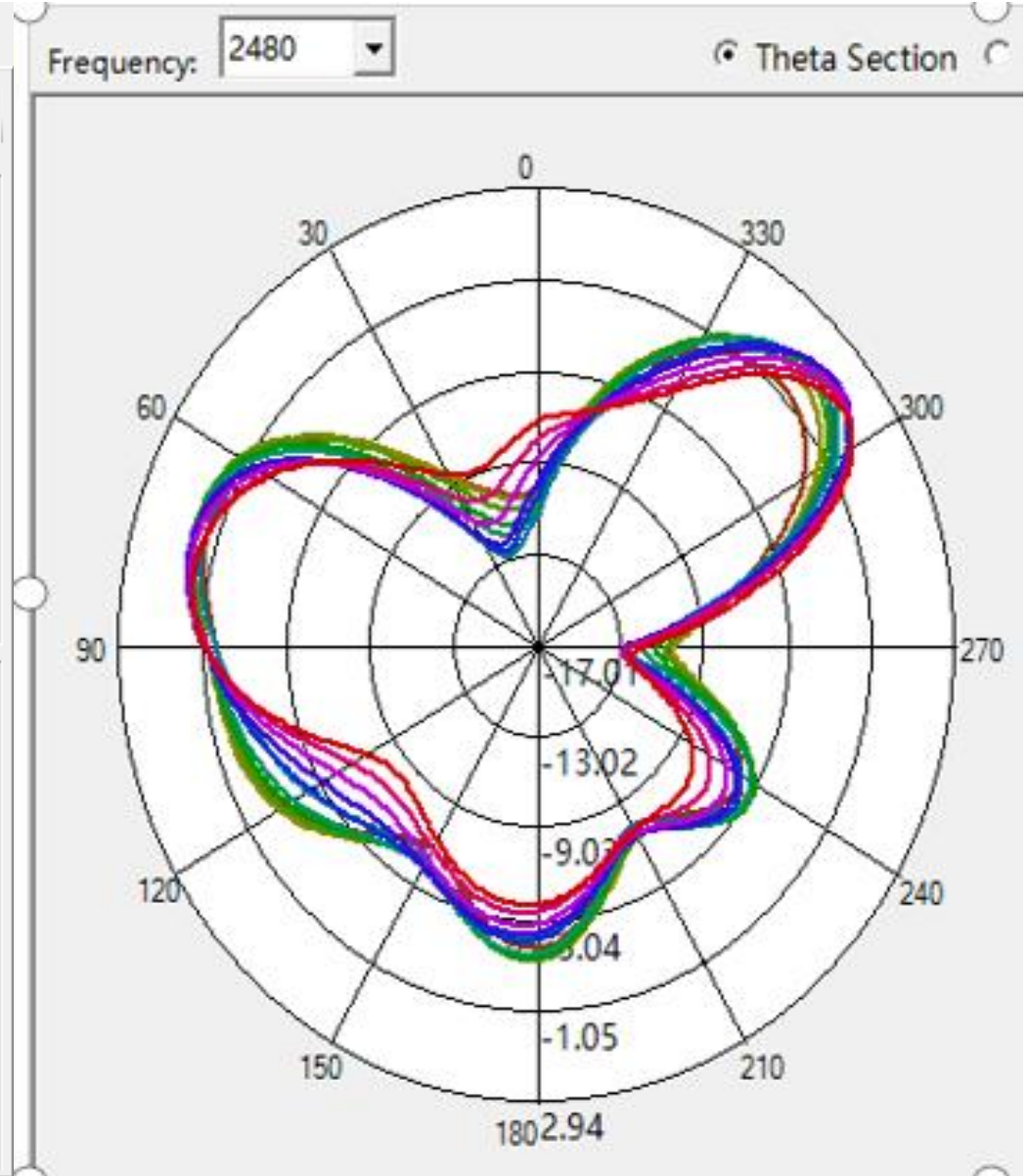
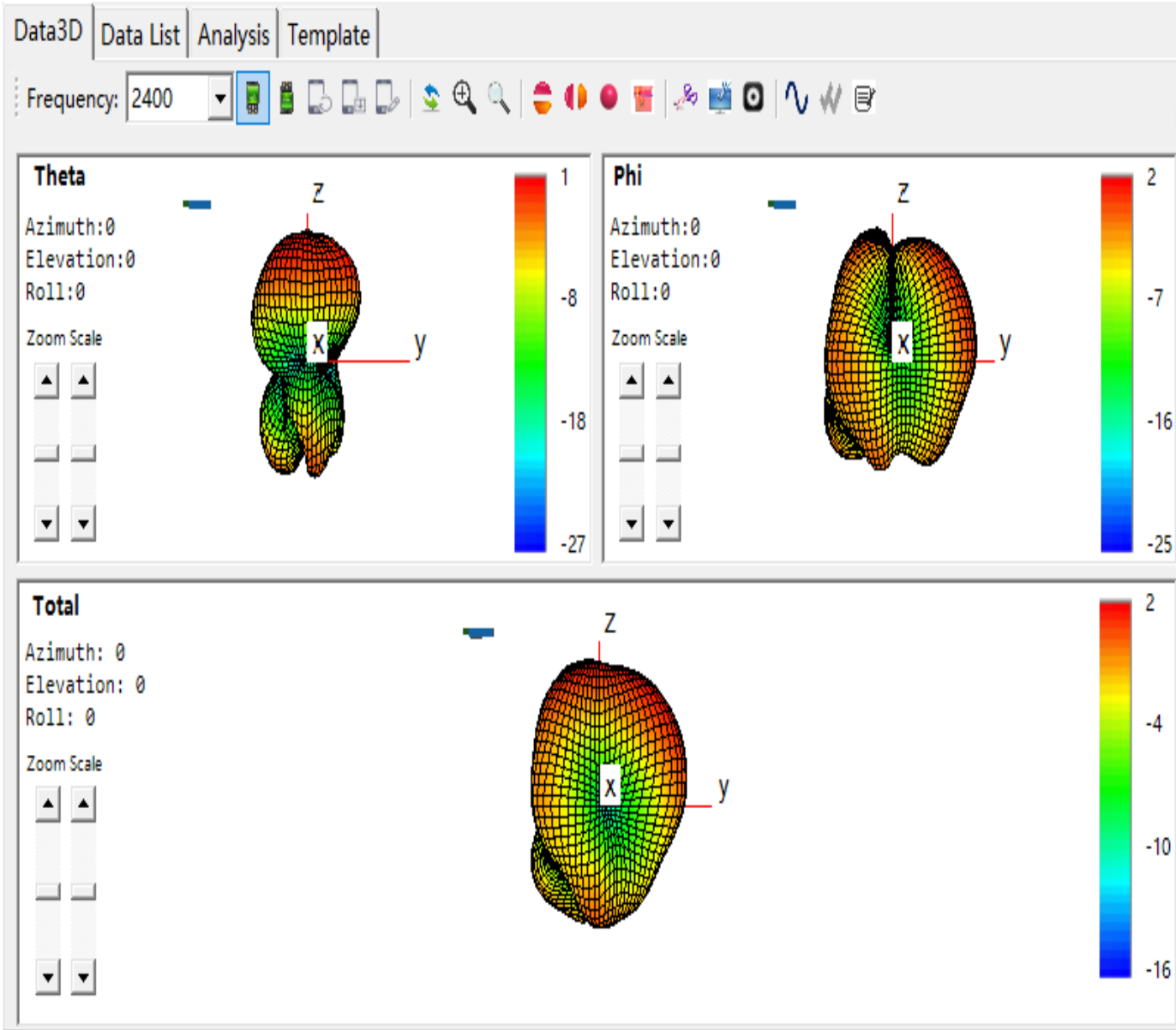

Frequency: 2440

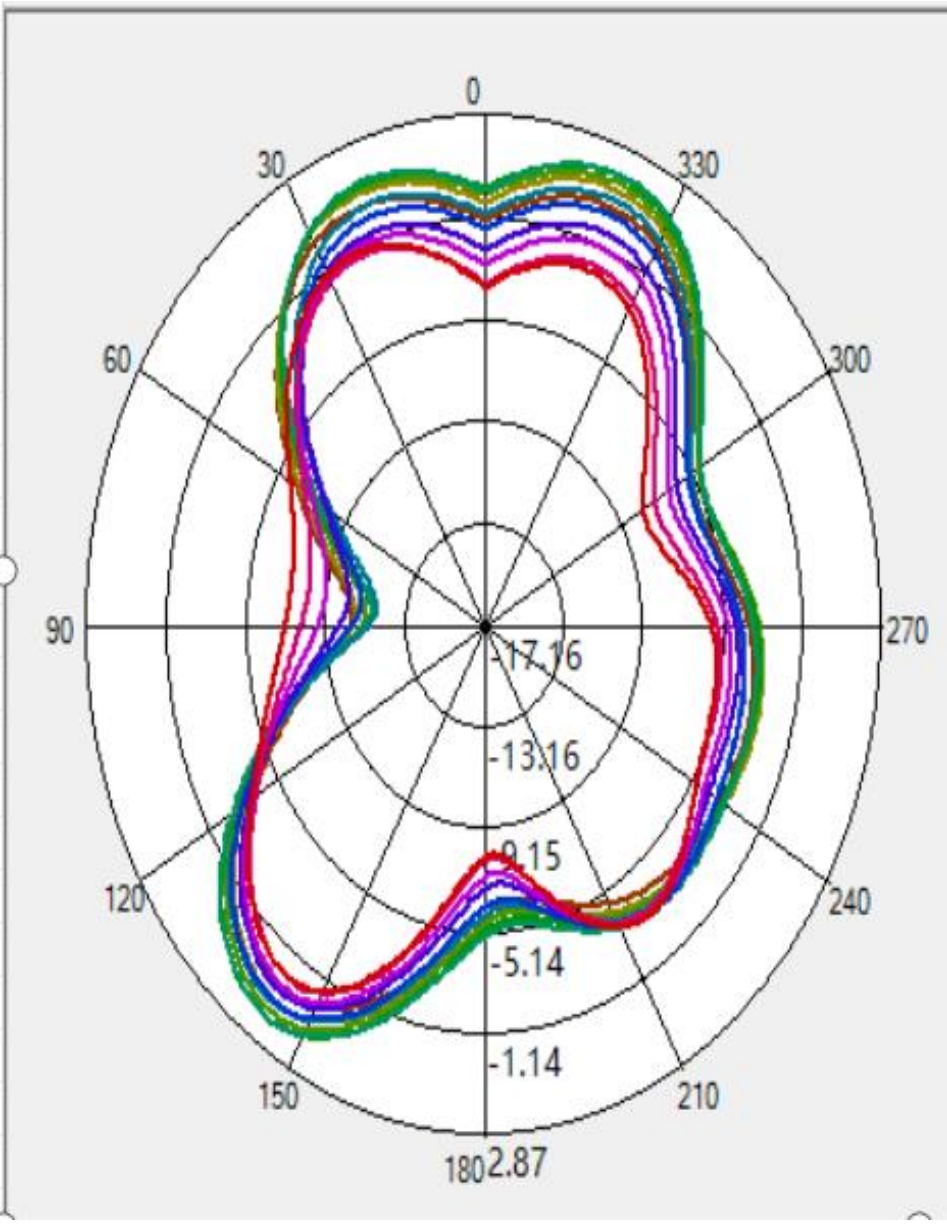
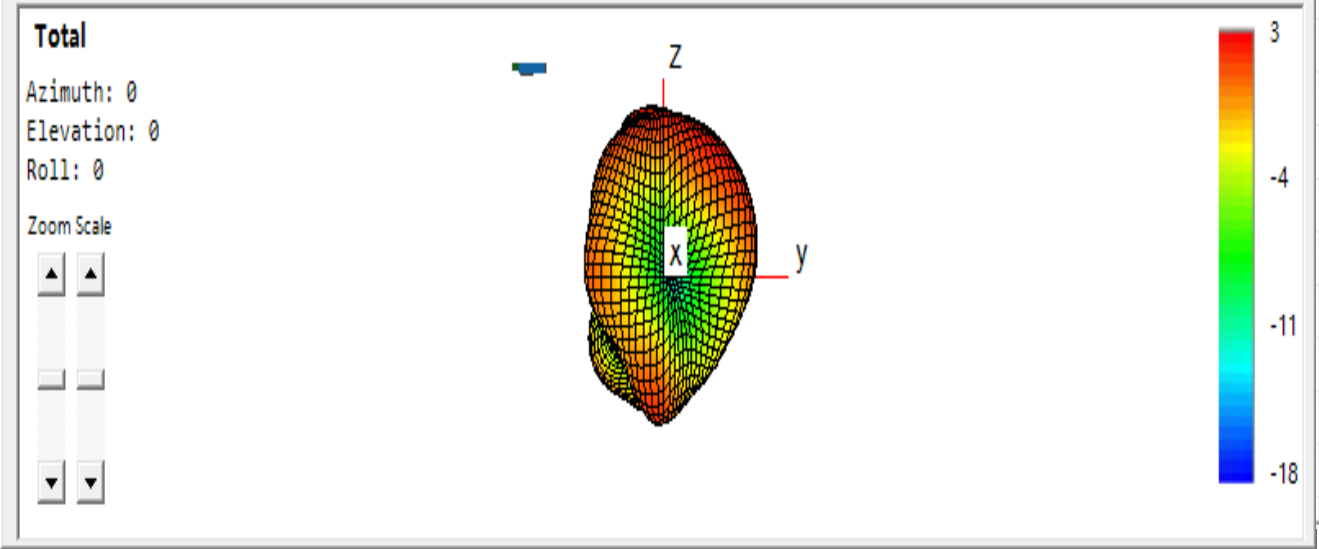
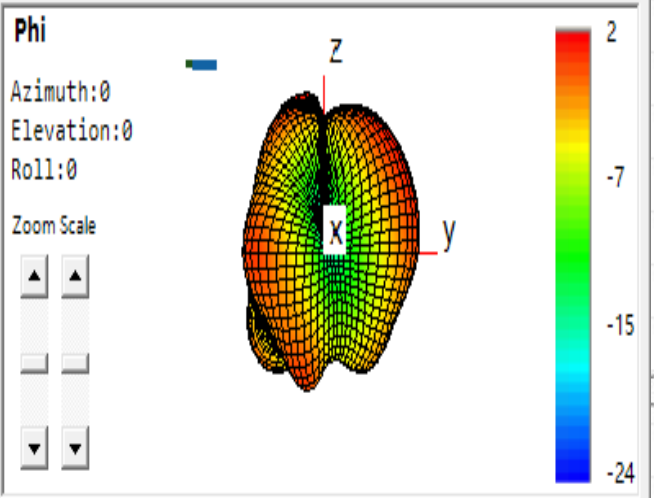
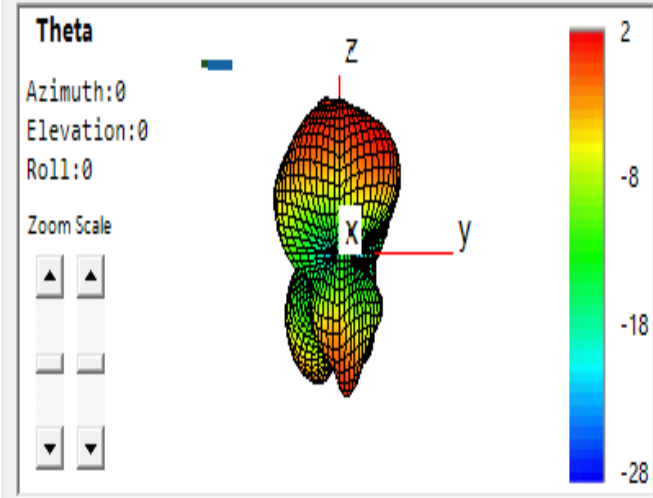

Frequency: 2480

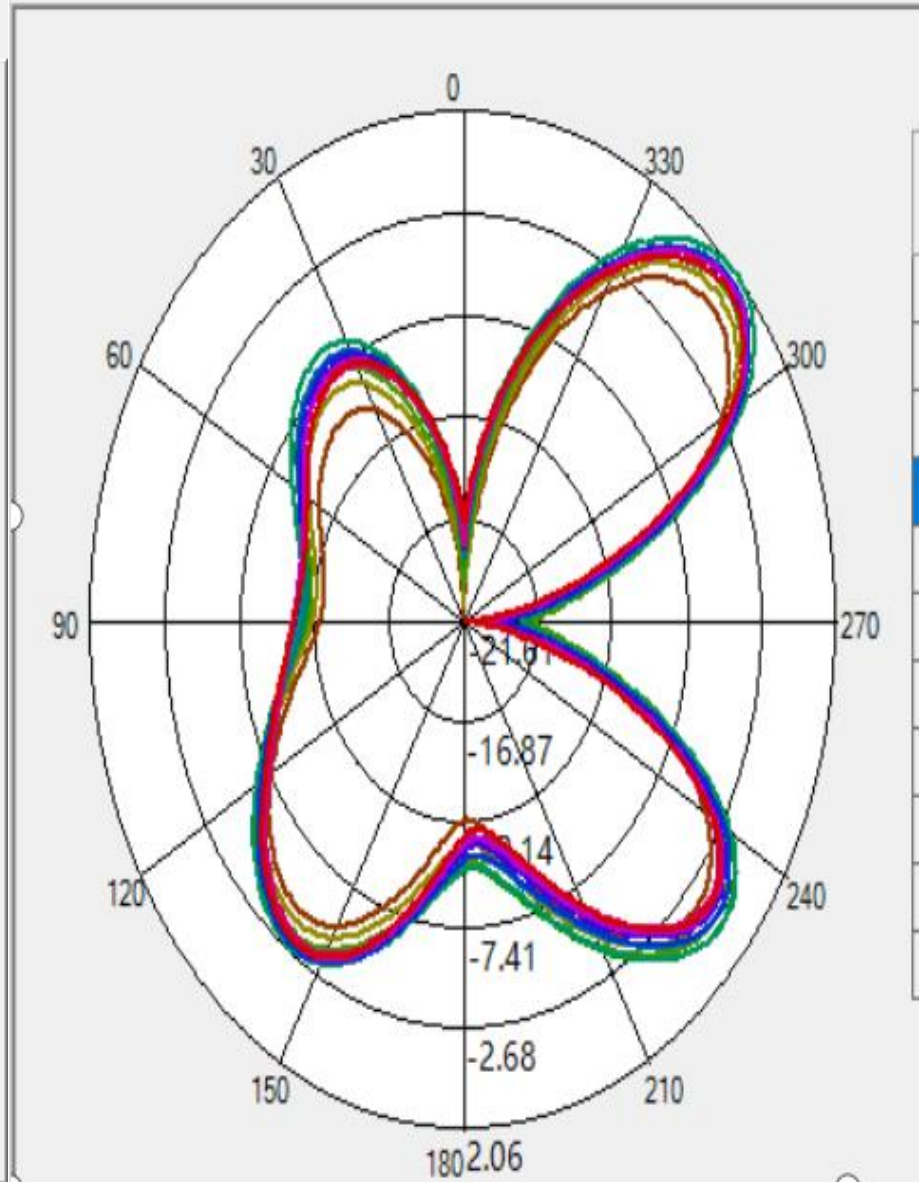
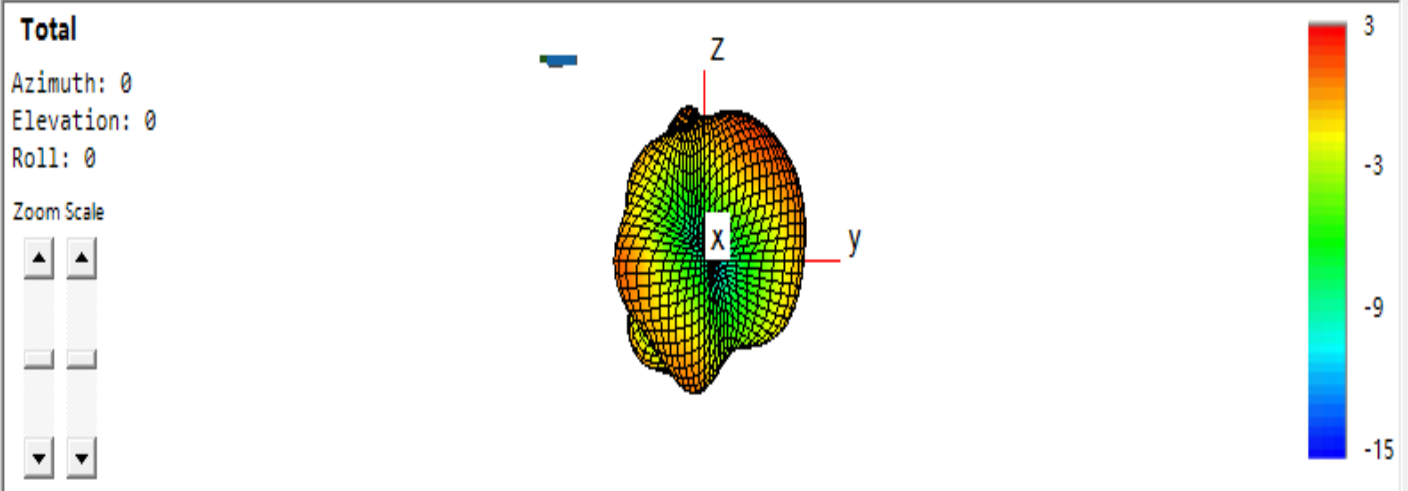
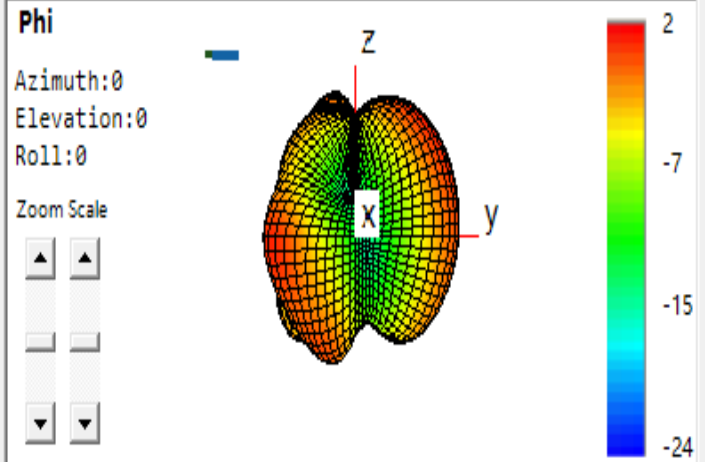
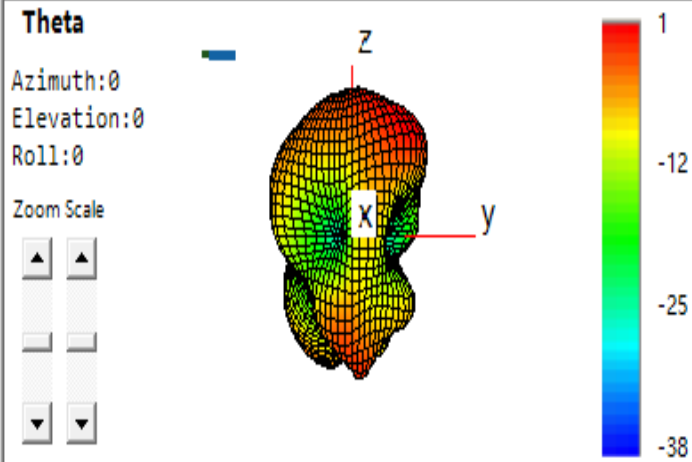

# Assembly drawing

1. 天线装配位置

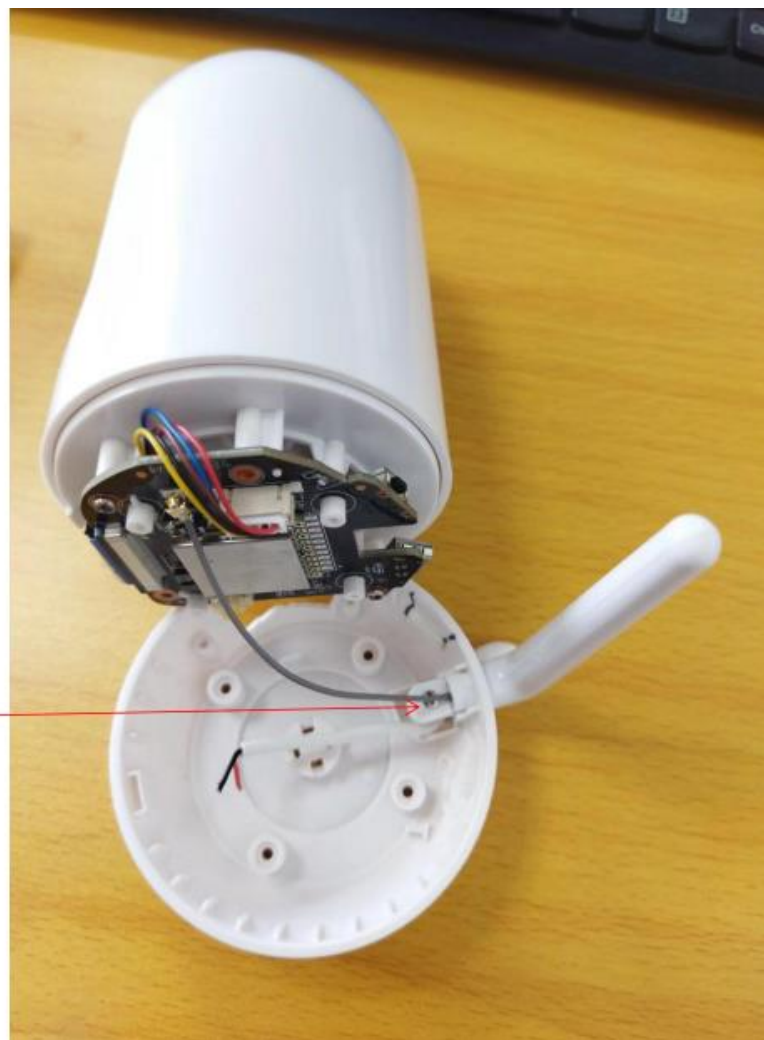



# Antenna size diagram

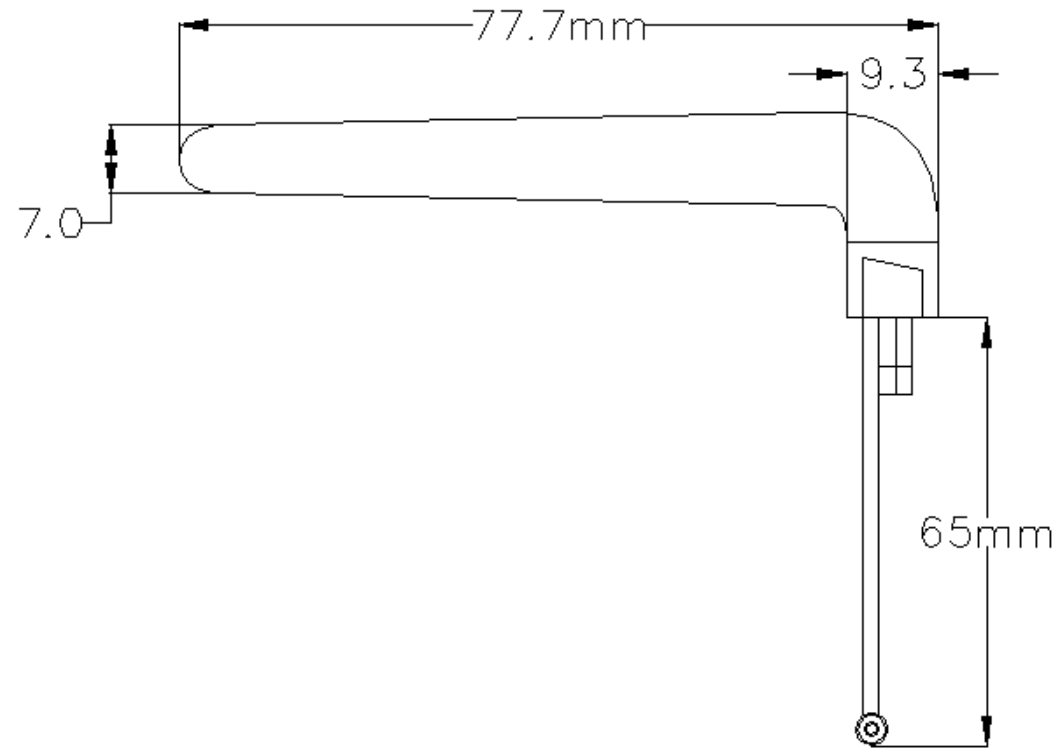

THANK YOU

