



**FCC TEST REPORT**  
**FCC ID: 2A6QM-WMS10-121**

On Behalf of

**Shenzhen Romoss Technology Co.,Ltd**

**Wireless Power Bank**

**Model No.: WMS10-121**

Prepared for : Shenzhen Romoss Technology Co.,Ltd  
Room1601, BLOCK B, Building 7,Shenzhen International Innovation  
Address : Valley, Dashi 1st Road Xili community, Xili Street, Nanshan , Shenzhen ,  
Guangdong, P.R.China

Prepared By : Shenzhen Alpha Product Testing Co., Ltd.  
Address : Building i, No.2, Lixin Road, Fuyong Street, Bao'an District,  
518103, Shenzhen, Guangdong, China

Report Number : A2308317-C01-R01  
Date of Receipt : September 6, 2023  
Date of Test : September 6, 2023–October 8, 2023  
Date of Report : October 8, 2023  
Version Number : V0

## TABLE OF CONTENTS

<b>Description</b>	<b>Page</b>
<b>1. Test Result Summary</b> .....	<b>5</b>
<b>2. EUT Description</b> .....	<b>6</b>
2.1. Description of Device (EUT).....	6
2.2. Accessories of Device (EUT) .....	8
2.3. Tested Supporting System Details.....	8
2.4. Block Diagram of Connection between EUT and Simulators.....	8
2.5. Description of Test Modes.....	8
2.6. Test Conditions .....	8
2.7. Test Facility .....	9
2.8. Measurement Uncertainty .....	9
<b>3. Test Results and Measurement Data</b> .....	<b>10</b>
3.1. RF Exposure Test .....	10
<b>3.1.1. Test Specification</b> .....	<b>10</b>
<b>3.1.2. Test Instruments</b> .....	<b>11</b>
<b>3.1.3. Test data</b> .....	<b>11</b>
<b>4. Photos of test setup</b> .....	<b>19</b>
<b>5. Photographs of EUT</b> .....	<b>37</b>



**Revision History**

Revision	Issue Date	Revisions	Revised By
V0	October 8, 2023	Initial released Issue	Yannis Wen

## 1. Test Result Summary

Requirement	CFR 47 Section	Result
RF EXPOSURE	§1.1307(b)(1) & KDB680106	PASS

**Note:**

1. *PASS: Test item meets the requirement.*
2. *Fail: Test item does not meet the requirement.*
3. *N/A: Test case does not apply to the test object.*
4. *The test result judgment is decided by the limit of test standard.*

## 2. EUT Description

### 2.1. Description of Device (EUT)

EUT Name	:	Wireless Power Bank
Model No.	:	WMS10-121
DIFF.	:	N/A
Power supply	:	Power from adapter DC 3.7V from battery
EUT information	:	Input : 5V = 3A or 9V = 2A (Lightning) Input : 5V = 2A or 9V = 2A (Lightning 1) Input : 5V = 3A or 9V = 2A (Type-C) Output : 5V = 3A or 9V = 2.22A, 12V = 1.67A(Lightning) Output : 5V = 3A or 9V = 2.22A, 12V = 1.67A(Type-C) Wireless Output :15W(Max) Total Output: 15W(Max)
Operation frequency	:	110~205KHz
Modulation	:	MSK
Antenna Type	:	Coil Antenna, Maximum Gain is 0dBi (This value is supplied by applicant).
Software version	:	MCU/FT61E14F/CS=0X9B1A/MSOP10/WMS10/ruizhen
Hardware version	:	WMS10-A V1.1-20230423
Intend use environment	:	Residential, commercial and light industrial environment

The EUT does comply with section 5 b) of KDB 680106 D01 RF Exposure Wireless charging App V03r01.

<b>Conditions requirement</b>	<b>Answers</b>
Power transfer frequency is less than 1 MHz.	After measuring the product the transfer frequency is 0.110-0.205MHz
Output power from each primary coil is less than or equal to 15 watts.	After measuring the product the each primary coil power is 15 watts
The system may consist of more than one source primary coils, charging one or more clients. If more than one primary coil is present, the coil pairs may be powered on at the same time.	The transfer system only include one primary.
Client device is placed directly in contact with the transmitter.	Client device is placed directly in contact with the transmitter.
Mobile exposure conditions only (portable exposure conditions are not covered by this exclusion).	Portable exposure conditions
The aggregate H-field strengths at 15 cm surrounding the device and 20 cm above the top surface from all simultaneous transmitting coils are demonstrated to be less than 50% of the MPE limit.	After measuring the product the Max H-field Strength is 0.806A/m Far less than 50% of the MPE limit.

## 2.2. Accessories of Device (EUT)

Accessories1 : Cable  
 Manufacturer : Shenzhen Romoss Technology Co.,Ltd  
 Model : /  
 Ratings : /

## 2.3. Tested Supporting System Details

No.	Description	Manufacturer	Model	Serial Number	Certification
1	Wireless load	--	--	--	--

## 2.4. Block Diagram of Connection between EUT and Simulators

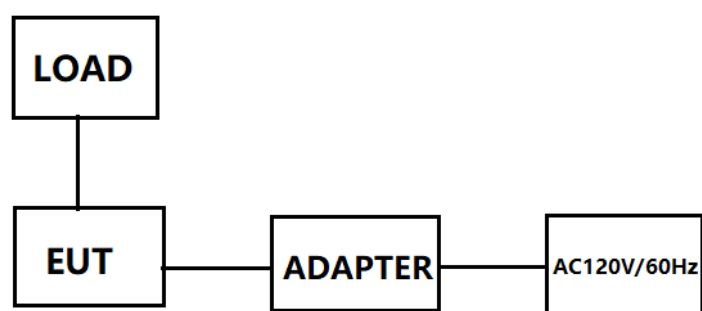

## 2.5. Description of Test Modes

Channel	Frequency (KHz)
1	128

## 2.6. Test Conditions

Items	Required	Actual
Temperature range:	15-35°C	24°C
Humidity range:	25-75%	56%
Pressure range:	86-106kPa	98kPa



## 2.7. Test Facility

Shenzhen Alpha Product Testing Co., Ltd

Building i, No.2, Lixin Road, Fuyong Street, Bao'an District, 518103, Shenzhen, Guangdong, China

June 21, 2018 File on Federal Communication Commission

Registration Number: 293961

July 15, 2019 Certificated by IC

Registration Number: CN0085

## 2.8. Measurement Uncertainty

(95% confidence levels, k=2)

Item	Uncertainty
Uncertainty for H-Field	2.39dB
Uncertainty for E-Field	2.45dB
Uncertainty for conducted RF Power	0.65dB
Uncertainty for temperature	0.2°C
Uncertainty for humidity	1%
Uncertainty for DC and low frequency voltages	0.06%

### 3. Test Results and Measurement Data

#### 3.1. RF Exposure Test

##### 3.1.1. Test Specification

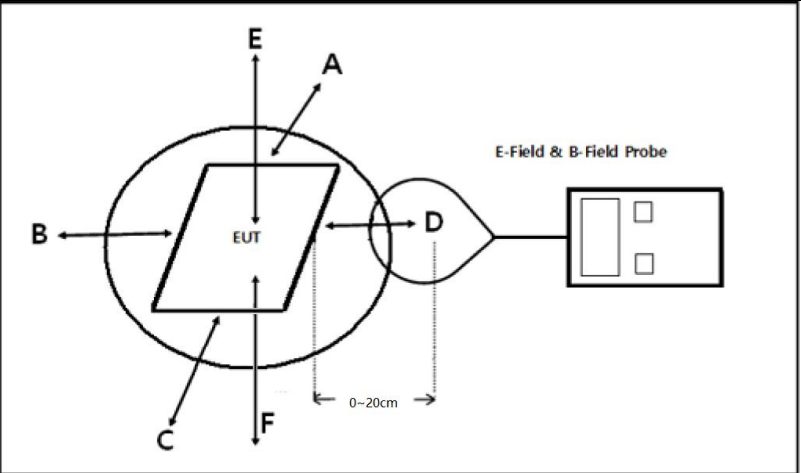
<b>Test Requirement:</b>	<b>FCC Rules and Regulations KDB680106</b>
<b>Test Method:</b>	§1.1307(b)(1) & KDB680106
<b>Limits:</b>	According to §1.1307(b)(1), systems operating under the provisions of this section shall be operated in a manner that ensures that the public is not exposed to radio frequency energy level in excess of the Commission's guidelines. According to §1.1310 and §2.1093 RF exposure is calculated. According KDB680106 D01v03r01: RF Exposure Wireless Charging.
<b>Test Setup:</b>	
<b>Test Mode:</b>	Wireless charging load has been charge at no load, middle load and full load. All test modes were pre-tested, but we only recorded the worse case in this report.
<b>Test Procedure:</b>	<ol style="list-style-type: none"> <li>1. The RF exposure test was performed in shielded chamber</li> <li>2. The measurement probe was placed at test distance(0~20cm) , step by 2cm, which is between the edge of the charger and the geometric centre of probe.</li> <li>3. The measurement probe used to search of highest strength.</li> <li>4. The highest emission level was recorded and compared with limit as soon as measurement of each points (A,B,C,D,E,F) were completed.</li> <li>5. The EUT were measured according to the dictates of KDB 680106 DR03-44118.</li> </ol>
<b>Test Result:</b>	PASS

## 3.1.2. Test Instruments

Item	Equipment	Manufacturer	Model No.	Firmware version	Serial No.	Last Cal.	Cal Interval
1	Exposure Level Tester	narda	ELT-400	/	N-0231	2023.08.22	1Year
2	Magnetic field probe 100cm2	narda	ELT probe 100cm2	/	M0675	2023.08.22	1Year
3	Isotropic Electric Field Probe	narda	EP-601	/	511WX60706	2023.08.16	1Year

## 3.1.3. Test data

For Wireless output (15W) mode:

For Full Load mode

H-Filed Strength

Operation frequency	Test Distance (cm)	Test Position	Probe Measure Result (A/m)	50% Limit (A/m)
110K-205K	0	A	0.794	0.815
		B	0.808	0.815
		C	0.799	0.815
		D	0.648	0.815
		E	0.804	0.815
		F	0.792	0.815

Operation frequency	Test Distance (cm)	Test Position	Probe Measure Result (A/m)	50% Limit (A/m)
110K-205K	2	A	0.793	0.815
		B	0.795	0.815
		C	0.807	0.815
		D	0.650	0.815
		E	0.806	0.815
		F	0.773	0.815

Operation frequency	Test Distance (cm)	Test Position	Probe Measure Result (A/m)	50% Limit (A/m)
110K-205K	4	A	0.795	0.815
		B	0.797	0.815
		C	0.809	0.815
		D	0.646	0.815
		E	0.804	0.815
		F	0.782	0.815

Operation frequency	Test Distance (cm)	Test Position	Probe Measure Result (A/m)	50% Limit (A/m)
110K-205K	6	A	0.801	0.815
		B	0.804	0.815
		C	0.793	0.815
		D	0.641	0.815
		E	0.792	0.815
		F	0.785	0.815

Operation frequency	Test Distance (cm)	Test Position	Probe Measure Result (A/m)	50% Limit (A/m)
110K-205K	8	A	0.799	0.815
		B	0.791	0.815
		C	0.803	0.815
		D	0.649	0.815
		E	0.808	0.815
		F	0.787	0.815

Operation frequency	Test Distance (cm)	Test Position	Probe Measure Result (A/m)	50% Limit (A/m)
110K-205K	10	A	0.805	0.815
		B	0.795	0.815
		C	0.805	0.815
		D	0.636	0.815
		E	0.792	0.815
		F	0.789	0.815

Operation frequency	Test Distance (cm)	Test Position	Probe Measure Result (A/m)	50% Limit (A/m)
110K-205K	12	A	0.775	0.815
		B	0.766	0.815
		C	0.761	0.815
		D	0.635	0.815
		E	0.755	0.815
		F	0.756	0.815

Operation frequency	Test Distance (cm)	Test Position	Probe Measure Result (A/m)	50% Limit (A/m)
110K-205K	14	A	0.654	0.815
		B	0.698	0.815
		C	0.617	0.815
		D	0.615	0.815
		E	0.577	0.815
		F	0.622	0.815

Operation frequency	Test Distance (cm)	Test Position	Probe Measure Result (A/m)	50% Limit (A/m)
110K-205K	16	A	0.652	0.815
		B	0.711	0.815
		C	0.602	0.815
		D	0.608	0.815
		E	0.582	0.815
		F	0.615	0.815

Operation frequency	Test Distance (cm)	Test Position	Probe Measure Result (A/m)	50% Limit (A/m)
110K-205K	18	A	0.653	0.815
		B	0.708	0.815
		C	0.603	0.815
		D	0.615	0.815
		E	0.585	0.815
		F	0.617	0.815

Operation frequency	Test Distance (cm)	Test Position	Probe Measure Result (A/m)	50% Limit (A/m)
110K-205K	20	A	0.649	0.815
		B	0.703	0.815
		C	0.608	0.815
		D	0.615	0.815
		E	0.577	0.815
		F	0.611	0.815

For No load mode:  
H-Filed Strength

Operation frequency	Test Distance (cm)	Test Position	Probe Measure Result (A/m)	50% Limit (A/m)
110K-205K	0	A	0.651	0.815
		B	0.657	0.815
		C	0.601	0.815
		D	0.614	0.815
		E	0.584	0.815
		F	0.618	0.815

Operation frequency	Test Distance (cm)	Test Position	Probe Measure Result (A/m)	50% Limit (A/m)
110K-205K	2	A	0.645	0.815
		B	0.656	0.815
		C	0.609	0.815
		D	0.616	0.815
		E	0.576	0.815
		F	0.612	0.815

Operation frequency	Test Distance (cm)	Test Position	Probe Measure Result (A/m)	50% Limit (A/m)
110K-205K	4	A	0.653	0.815
		B	0.654	0.815
		C	0.602	0.815
		D	0.613	0.815
		E	0.575	0.815
		F	0.619	0.815

Operation frequency	Test Distance (cm)	Test Position	Probe Measure Result (A/m)	50% Limit (A/m)
110K-205K	6	A	0.650	0.815
		B	0.655	0.815
		C	0.605	0.815
		D	0.614	0.815
		E	0.582	0.815
		F	0.612	0.815

Operation frequency	Test Distance (cm)	Test Position	Probe Measure Result (A/m)	50% Limit (A/m)
110K-205K	8	A	0.647	0.815
		B	0.652	0.815
		C	0.602	0.815
		D	0.606	0.815
		E	0.577	0.815
		F	0.616	0.815

Operation frequency	Test Distance (cm)	Test Position	Probe Measure Result (A/m)	50% Limit (A/m)
110K-205K	10	A	0.650	0.815
		B	0.662	0.815
		C	0.609	0.815
		D	0.606	0.815
		E	0.583	0.815
		F	0.608	0.815

Operation frequency	Test Distance (cm)	Test Position	Probe Measure Result (A/m)	50% Limit (A/m)
110K-205K	12	A	0.650	0.815
		B	0.662	0.815
		C	0.607	0.815
		D	0.617	0.815
		E	0.580	0.815
		F	0.609	0.815

Operation frequency	Test Distance (cm)	Test Position	Probe Measure Result (A/m)	50% Limit (A/m)
110K-205K	14	A	0.653	0.815
		B	0.661	0.815
		C	0.610	0.815
		D	0.612	0.815
		E	0.579	0.815
		F	0.608	0.815

Operation frequency	Test Distance (cm)	Test Position	Probe Measure Result (A/m)	50% Limit (A/m)
110K-205K	16	A	0.652	0.815
		B	0.661	0.815
		C	0.604	0.815
		D	0.617	0.815
		E	0.580	0.815
		F	0.612	0.815

Operation frequency	Test Distance (cm)	Test Position	Probe Measure Result (A/m)	50% Limit (A/m)
110K-205K	18	A	0.644	0.815
		B	0.659	0.815
		C	0.606	0.815
		D	0.606	0.815
		E	0.577	0.815
		F	0.608	0.815

Operation frequency	Test Distance (cm)	Test Position	Probe Measure Result (A/m)	50% Limit (A/m)
110K-205K	20	A	0.650	0.815
		B	0.657	0.815
		C	0.606	0.815
		D	0.607	0.815
		E	0.580	0.815
		F	0.618	0.815

For Wireless output (5W)+Lighting output+Type-C output mode:

For Full load mode:

H-Filed Strength

Operation frequency	Test Distance (cm)	Test Position	Probe Measure Result (A/m)	50% Limit (A/m)
110K-205K	0	A	0.799	0.815
		B	0.814	0.815
		C	0.806	0.815
		D	0.656	0.815
		E	0.811	0.815
		F	0.795	0.815

Operation frequency	Test Distance (cm)	Test Position	Probe Measure Result (A/m)	50% Limit (A/m)
110K-205K	2	A	0.801	0.815
		B	0.809	0.815
		C	0.809	0.815
		D	0.648	0.815
		E	0.813	0.815
		F	0.794	0.815

Operation frequency	Test Distance (cm)	Test Position	Probe Measure Result (A/m)	50% Limit (A/m)
110K-205K	4	A	0.801	0.815
		B	0.813	0.815
		C	0.809	0.815
		D	0.653	0.815
		E	0.808	0.815
		F	0.797	0.815



Operation frequency	Test Distance (cm)	Test Position	Probe Measure Result (A/m)	50% Limit (A/m)
110K-205K	6	A	0.800	0.815
		B	0.809	0.815
		C	0.807	0.815
		D	0.657	0.815
		E	0.804	0.815
		F	0.793	0.815

Operation frequency	Test Distance (cm)	Test Position	Probe Measure Result (A/m)	50% Limit (A/m)
110K-205K	8	A	0.803	0.815
		B	0.813	0.815
		C	0.803	0.815
		D	0.652	0.815
		E	0.804	0.815
		F	0.801	0.815

Operation frequency	Test Distance (cm)	Test Position	Probe Measure Result (A/m)	50% Limit (A/m)
110K-205K	10	A	0.797	0.815
		B	0.803	0.815
		C	0.788	0.815
		D	0.657	0.815
		E	0.797	0.815
		F	0.784	0.815

Operation frequency	Test Distance (cm)	Test Position	Probe Measure Result (A/m)	50% Limit (A/m)
110K-205K	12	A	0.791	0.815
		B	0.802	0.815
		C	0.795	0.815
		D	0.649	0.815
		E	0.792	0.815
		F	0.782	0.815

Operation frequency	Test Distance (cm)	Test Position	Probe Measure Result (A/m)	50% Limit (A/m)
110K-205K	14	A	0.797	0.815
		B	0.806	0.815
		C	0.792	0.815
		D	0.657	0.815
		E	0.796	0.815
		F	0.785	0.815

Operation frequency	Test Distance (cm)	Test Position	Probe Measure Result (A/m)	50% Limit (A/m)
110K-205K	16	A	0.792	0.815
		B	0.810	0.815
		C	0.797	0.815
		D	0.649	0.815
		E	0.798	0.815
		F	0.785	0.815

Operation frequency	Test Distance (cm)	Test Position	Probe Measure Result (A/m)	50% Limit (A/m)
110K-205K	18	A	0.790	0.815
		B	0.803	0.815
		C	0.798	0.815
		D	0.653	0.815
		E	0.800	0.815
		F	0.789	0.815

Operation frequency	Test Distance (cm)	Test Position	Probe Measure Result (A/m)	50% Limit (A/m)
110K-205K	20	A	0.789	0.815
		B	0.806	0.815
		C	0.791	0.815
		D	0.655	0.815
		E	0.800	0.815
		F	0.782	0.815

### Photos of test setup

Wireless output (15W)

For Full load mode



0cm A Position

For No load mode



0cm A Position

For Full load mode

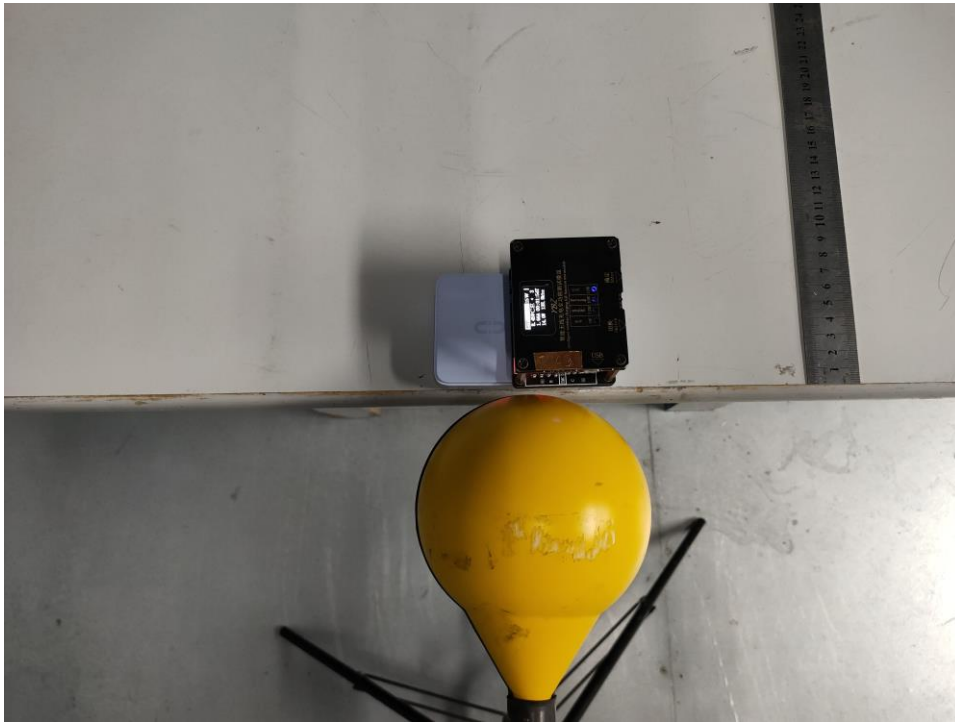

0cm B Position

For No load mode



0cm B Position

For Full load mode



0cm C Position

For No load mode



0cm C Position

For Full load mode



0cm D Position

For No load mode



0cm D Position

For Full load mode



0cm E Position

For No load mode



0cm E Position



For Full load mode



0cm F Position

For No load mode



0cm F Position



For Full load mode



20cm A Position

For No load mode



20cm A Position

For Full load mode

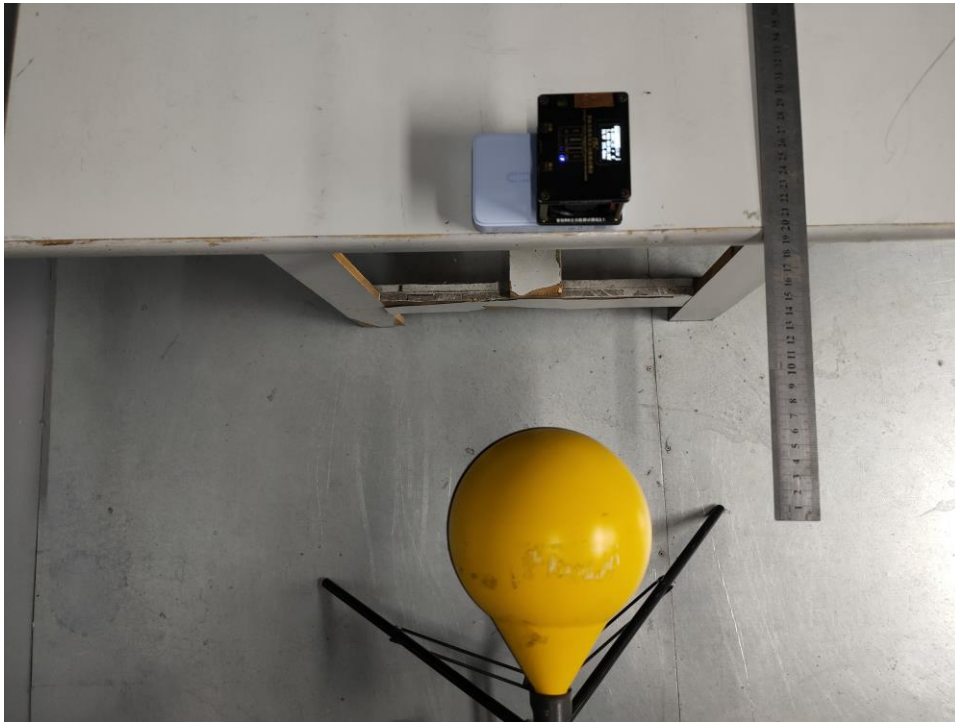

20cm B Position

For No load mode

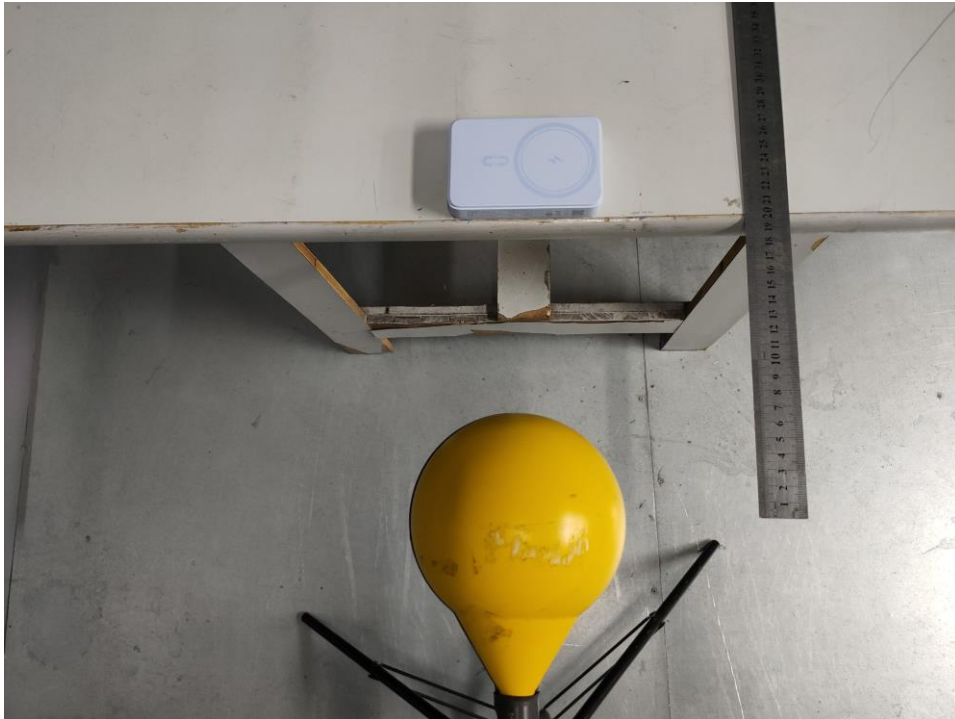

20cm B Position

For Full load mode

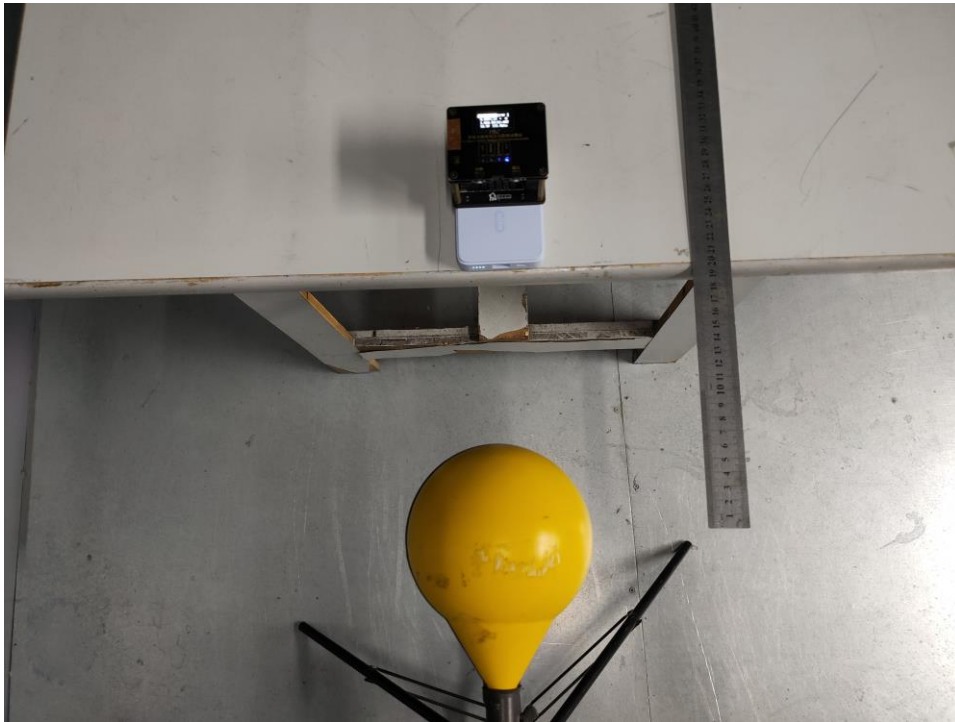

20cm C Position

For No load mode

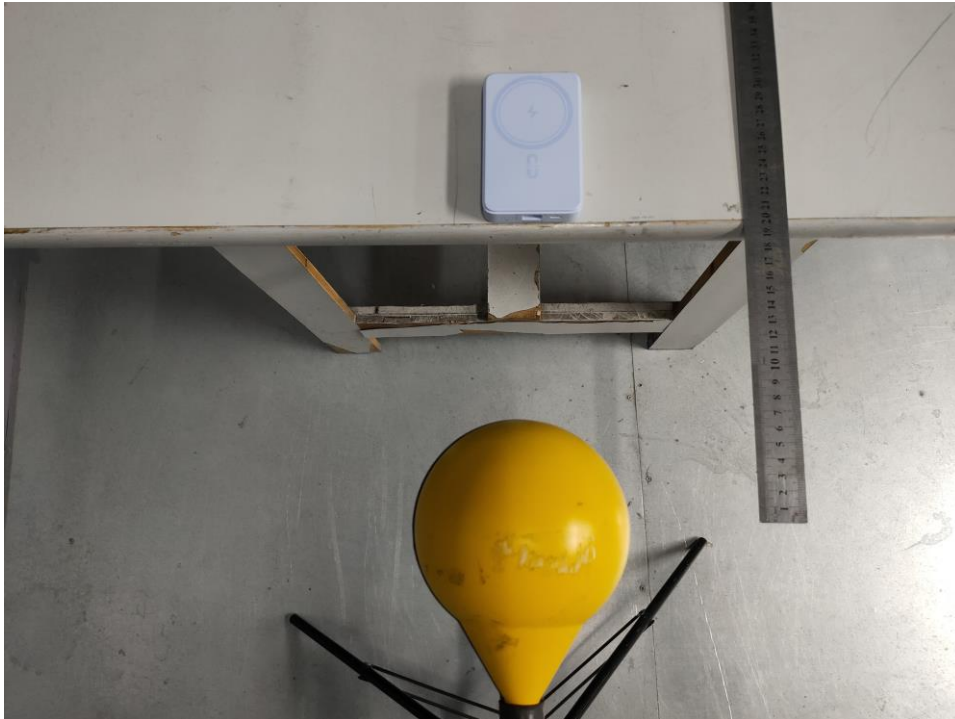

20cm C Position

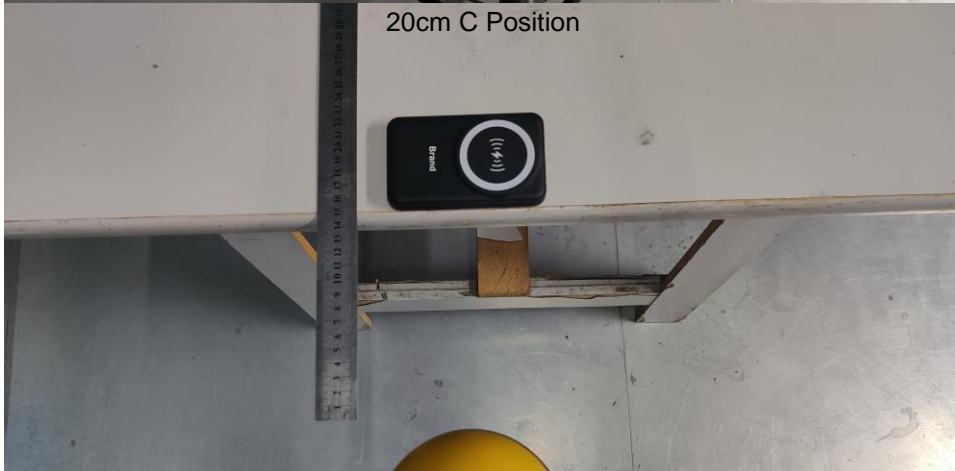

For Full load mode

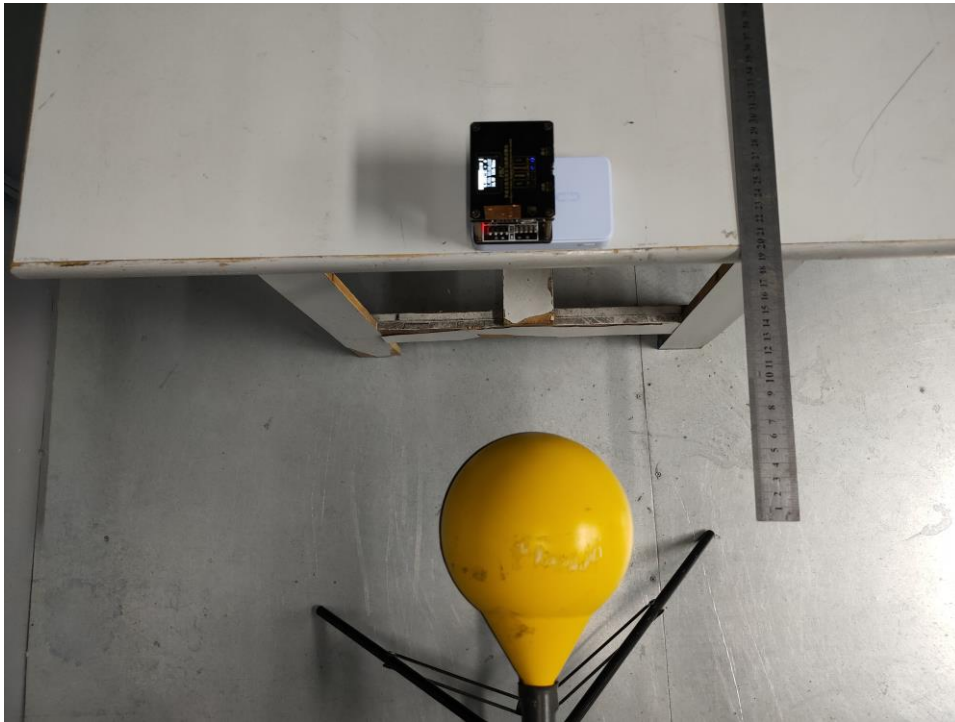

20cm D Position

For No load mode



20cm D Position



For Full load mode

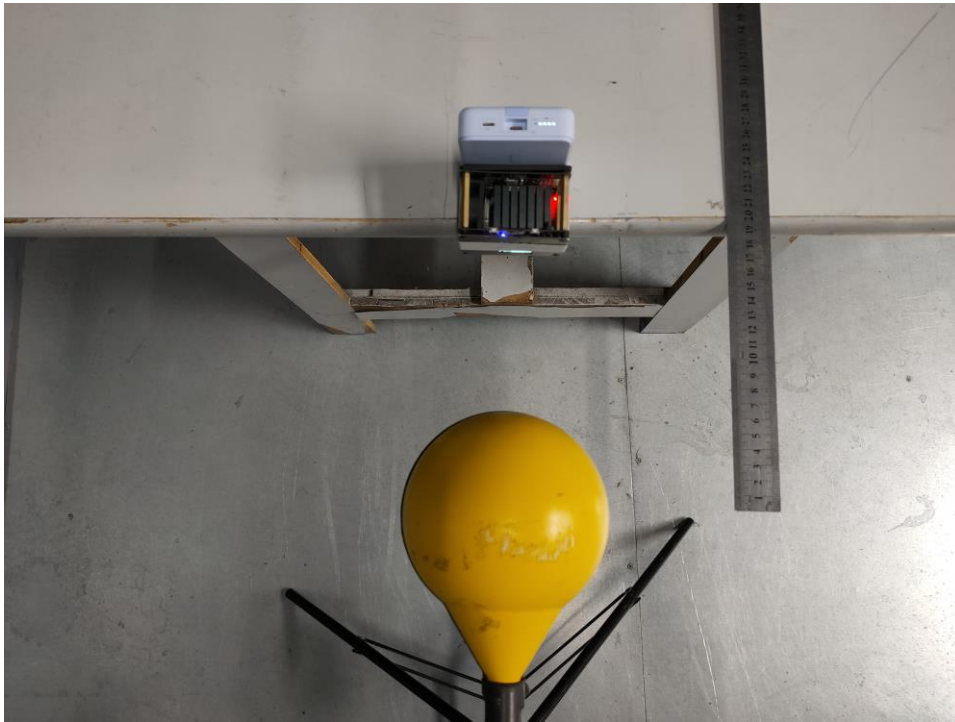

20cm E Position

For No load mode



20cm E Position

For Full load mode



20cm F Position

For No load mode



20cm F Position

Wireless output (5W)+Lighting output+Type-C output

For Full load mode

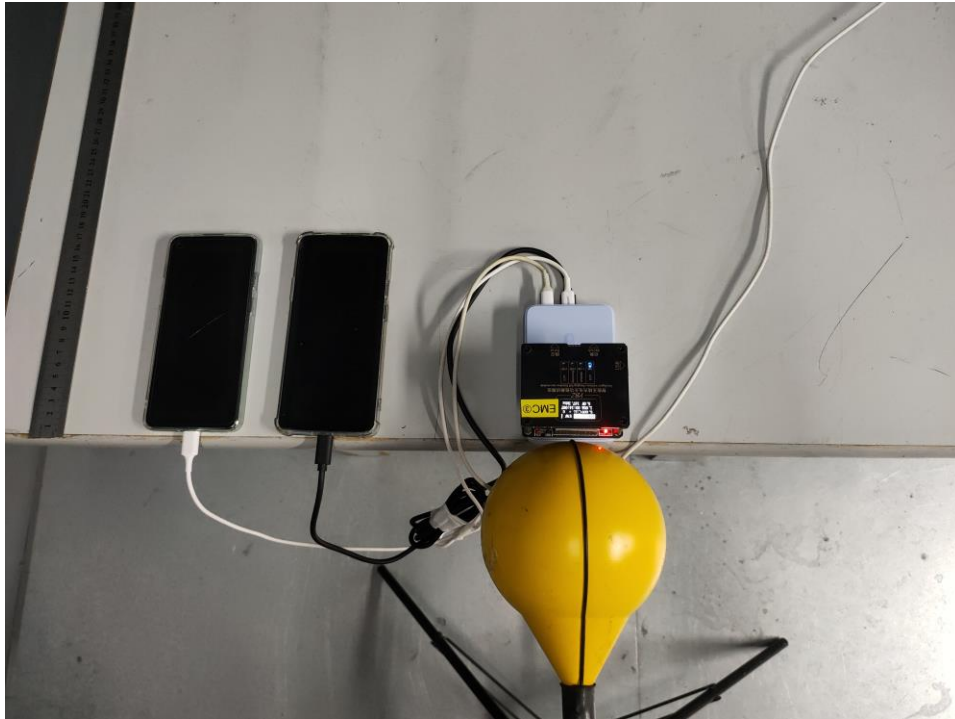

0cm A Position

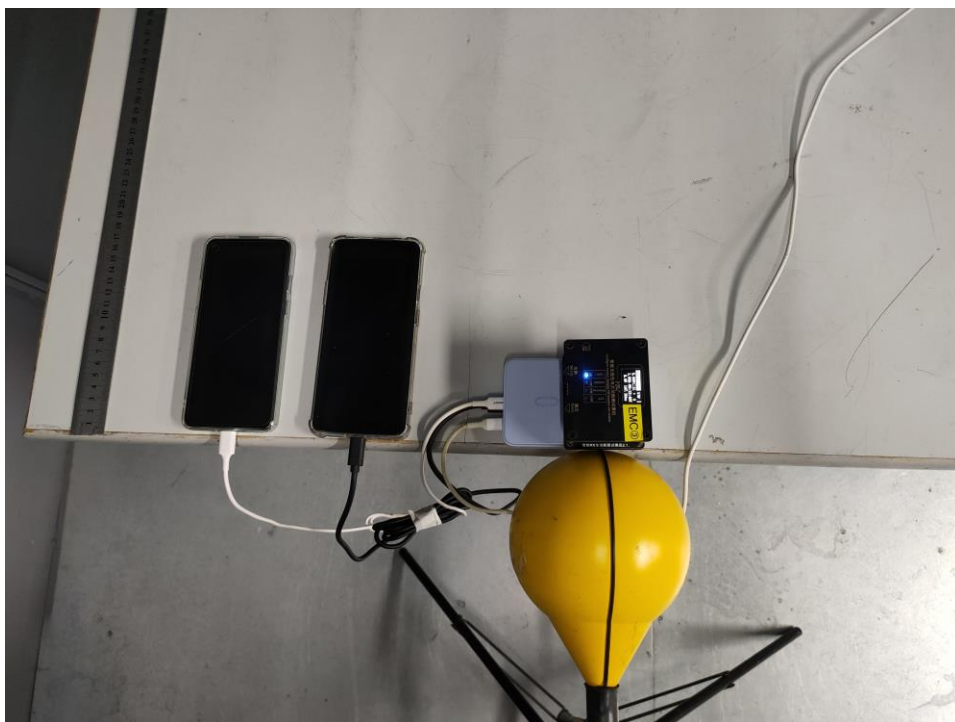

0cm B Position



For Full load mode

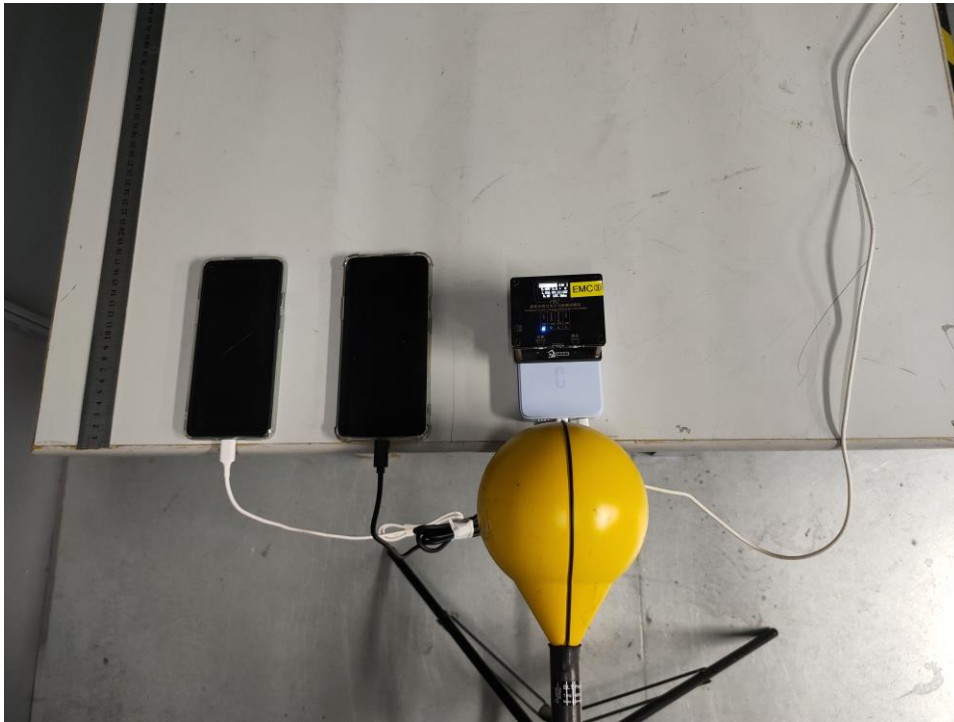

0cm C Position

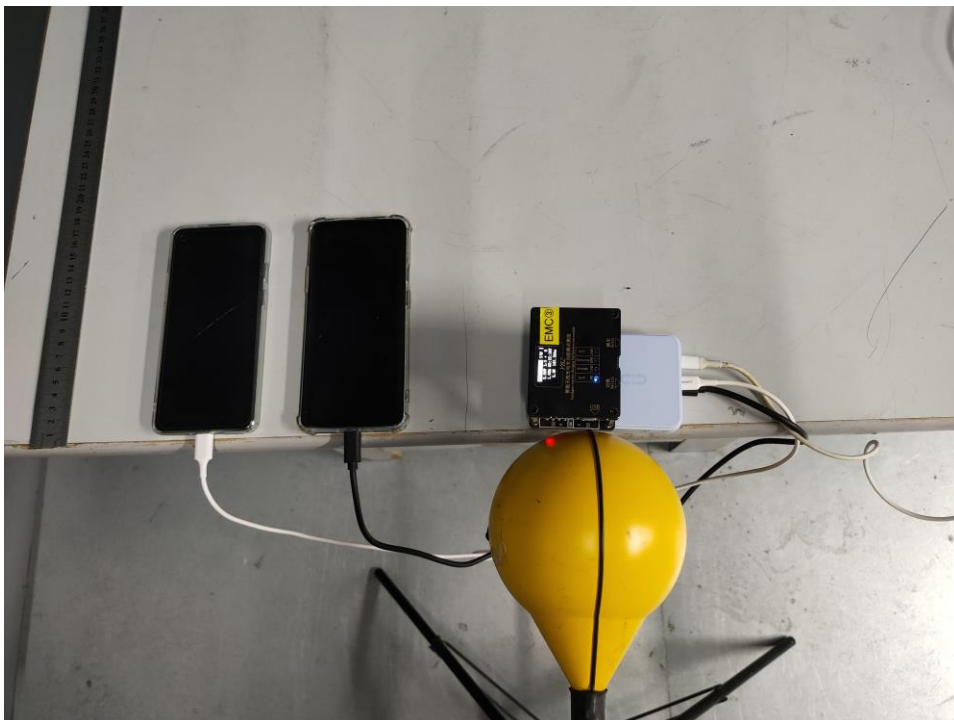

0cm D Position



For Full load mode

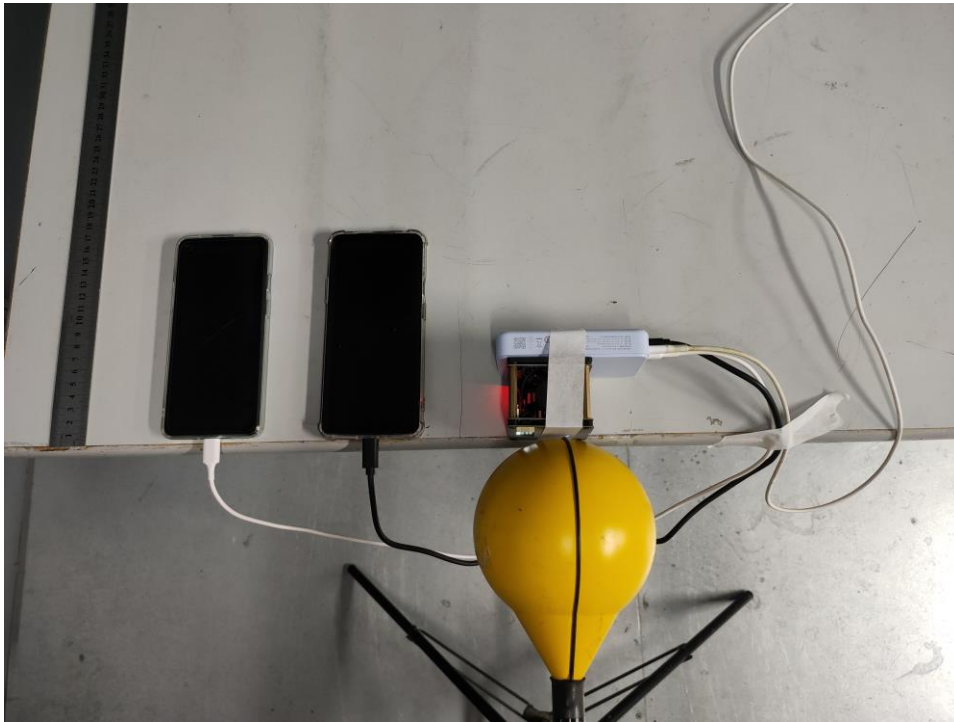

0cm E Position

For No load mode

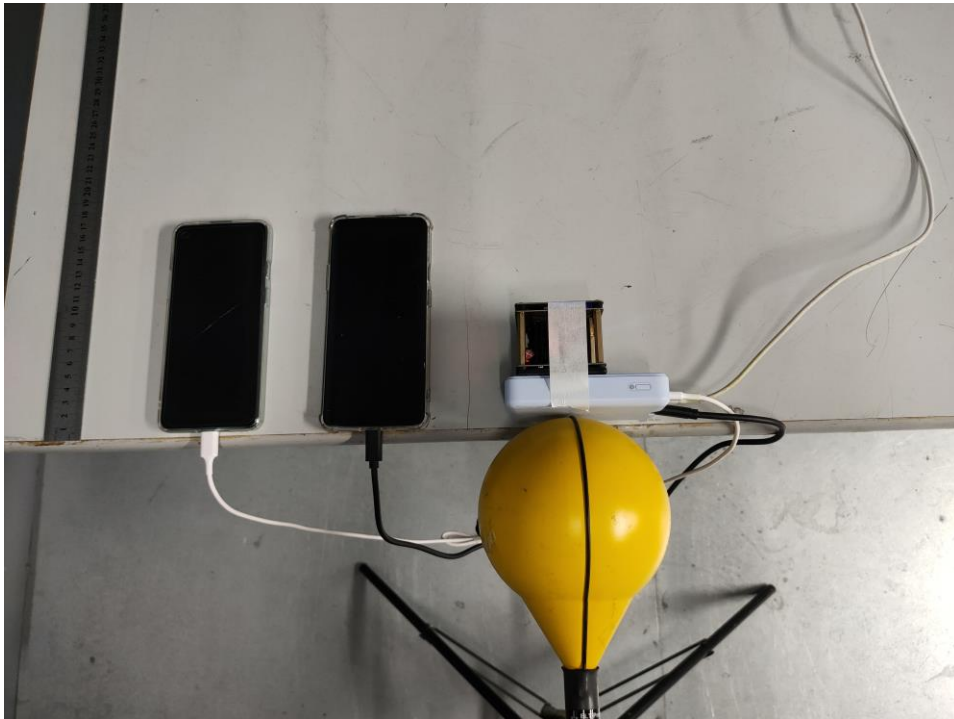

0cm F Position

For Full load mode



20cm A Position

For No load mode



20cm B Position

For Full load mode



20cm C Position

For No load mode

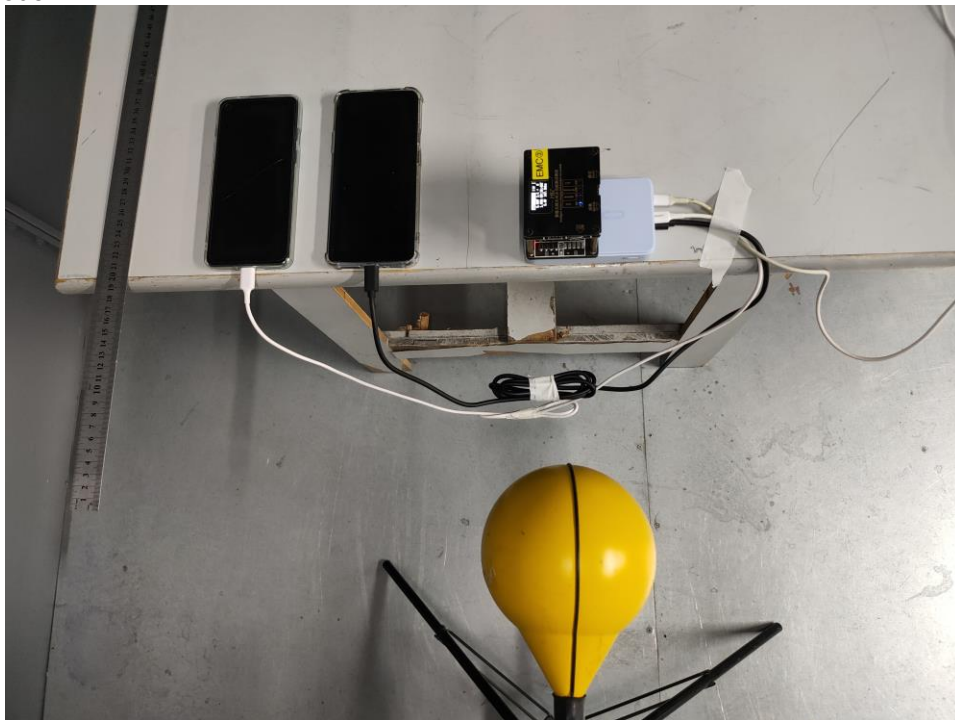

20cm D Position

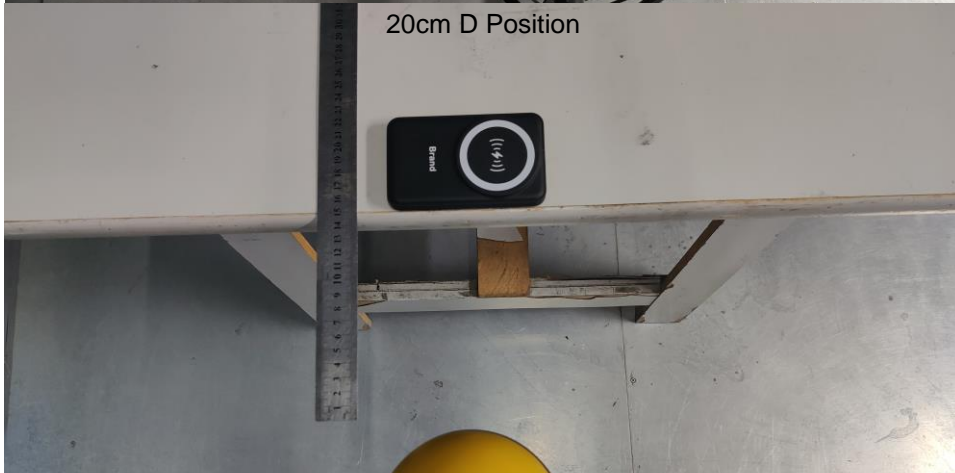



For Full load mode

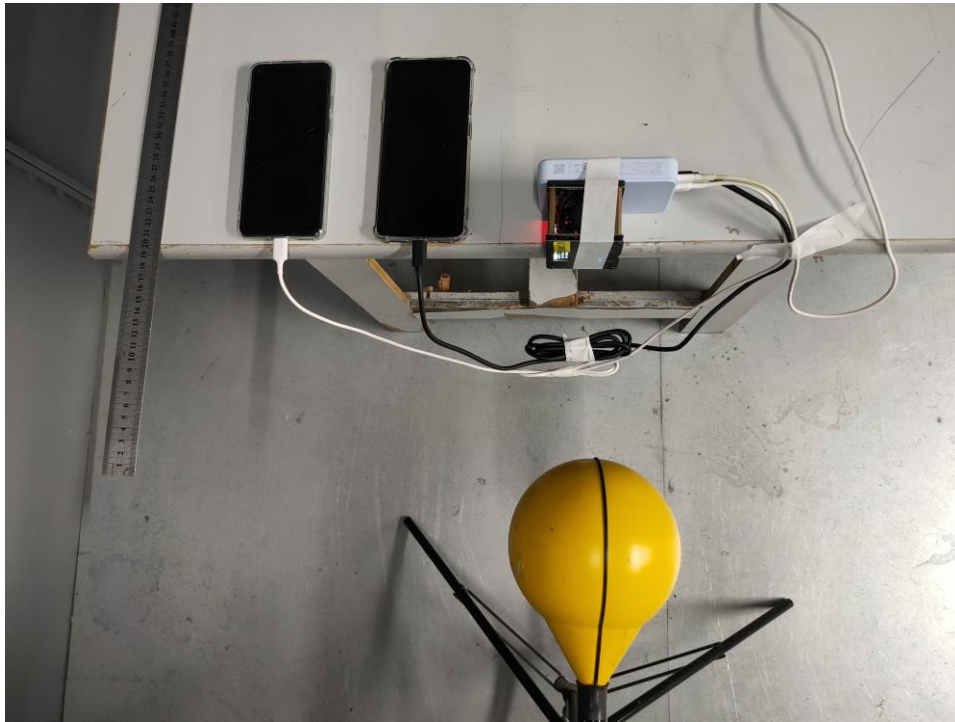

20cm E Position

For No load mode

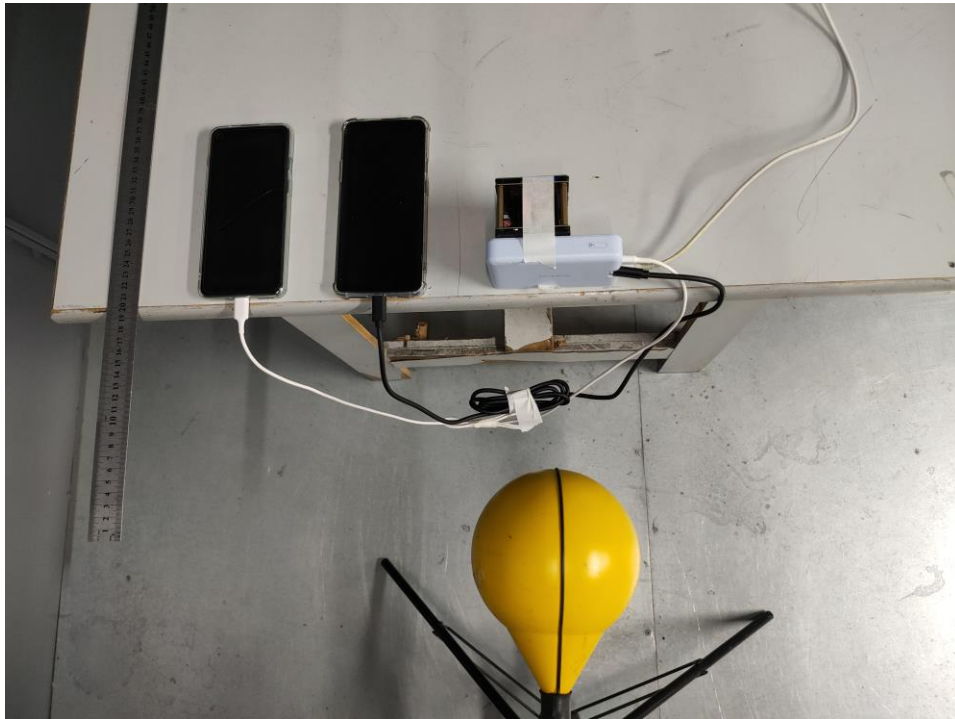

20cm F Position

#### 4. Photographs of EUT











-----End of Report-----