

# Digital Camera Easy Guide

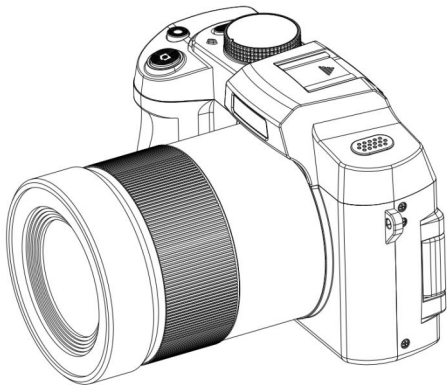

# Contents

<b>WARNING</b> .....	1
<b>CAUTION</b> .....	1
<b>About the camera</b> .....	2
System requirement .....	2
Parts and controls.....	2
Charging the battery.....	5
Touch function.....	6
<b>Power on/off the camera</b> .....	7
<b>Set the camera</b> .....	7
<b>Insert and format the memory card</b> .....	9
Format the memory card.....	9
<b>Using the camera</b> .....	10
Focus function.....	12
Fully automatic focus.....	12
Manual focus.....	12
Macro focus .....	12
Fill light.....	12
<b>Playback</b> .....	13
<b>Connect to computer</b> .....	14
Charging Mode .....	14
Mass Storage Mode.....	14
PC Camera .....	15
Connect to the Zero Cam app.....	15
Download the app and connect the camera's Wi-Fi network .....	15
System requirement (of smartphone).....	16
Camera cleaning and maintenance.....	17
Troubleshooting .....	17
Additional notes .....	18

## WARNING

To reduce the risk of fire or electric shock,

1. Do not expose the unit to rain or moisture.
2. Do not place objects filled with liquids, such as vases, on the apparatus.
3. Do not expose the batteries to excessive heat such as sunshine, fire or the like.
4. Do not ingest battery, chemical burn hazard.
5. Keep new and used batteries away from children. If the battery compartment does not close securely, stop using the product and keep it away from children.
6. If you think batteries might have been swallowed or placed inside any part of body, seek immediate medical attention.

## CAUTION

If the battery is mishandled, the battery pack can burst, cause a fire or even chemical burns. Observe the following cautions.

Do not disassemble.

Do not crush and do not expose the battery pack to any shock or force such as hammering, dropping or stepping on it.

Do not short circuit and do not allow metal objects to come into contact with the battery terminals.

Do not expose to high temperature above 60°C (140°F) such as in direct sunlight or in a car parked in the sun.

Do not incinerate or dispose of in fire.

Do not handle damaged or leaking lithium ion batteries.

Keep the battery pack out of the reach of small children.

Keep the battery pack dry.

Replace the battery with the specified type only. Otherwise, burst, fire or injury may result.

Dispose of used batteries according to the instruction.

Use a nearby wall outlet (wall socket) when using the AC Adapter/Battery charger.

If any malfunction occurs, disconnect the plug from the wall outlet immediately to disconnect from the power source. If you use the product with a charge lamp, note that the product is not disconnected from the power source even when the lamp turns off.

Do not use the AC adapter/Battery charger placed in a narrow space, such as between a wall and furniture.

If static electricity or electromagnetism cause data transfer to discontinue midway (fail), restart the application or disconnect and connect the communication cable (USB, etc.) again.

# About the camera

---

## System requirement

Users can transfer videos and photos to computers with the following configurations:

Intel Pentium 2.0GHz or higher/ Microsoft Windows XP or higher operating system 2GB RAM 40GB above available disk memory/ Standard USB interface / 1GB GPU or higher 1920x1080 pixel or higher resolution.

## Parts and controls

**Rear view**

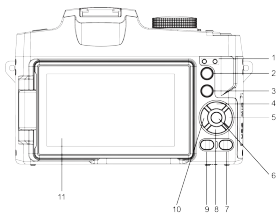

- 1: Charging/working indicator light
- 2: Digital zoom in
- 3: Digital zoom out
- 4: Up Button/shortcut button for fill light
- 5: Right Button/Long press to turn on WiFi
- 6: OK Button
- 7: Menu Button

**Front view**

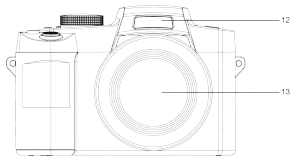

- 8: Down Button/Delete Button
- 9: Playback Button
- 10: Left Button
- 11: Display Screen
- 12: Fill light
- 13: Lens

### Top side view

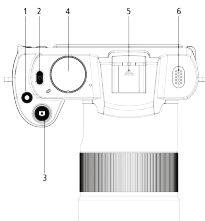

- 1: Video Button
- 2: Power Button
- 3: Photo Button
- 4: Mode Dial

### Bottom side view

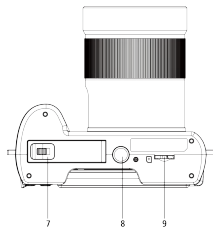

- 5: Cold Shoe Mount
- 6: Loudspeaker
- 7: Battery Compartment
- 8: Tripod Interface
- 9: Memory Card Slot

### Left side view

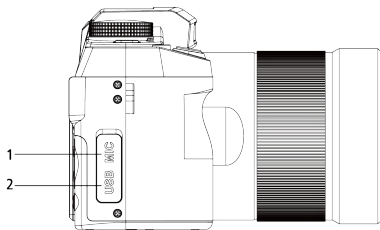

- 1: Microphone Interface
- 2: Type-C USB Interface

<b>Buttons/ Indicators</b>	<b>Functions</b>
POWER	Power on / off / Short press to pause video while recording
PHOTO	Take photo/Half-press to focus
VIDEO	Start recording/end recording
Mode dial	Switch shooting mode
T	digital zoom in
W	Digital zoom out
Indicator light	Working / Charging indicator light
Up	Upward
	Turn on/off the fill light/Exit WiFi
Right	Rightward
	Switching Filters
Down	Downward
	Delete photo/video
	Short press to turn the display on or off
Left	Leftward
OK	Confirm
Playback	Open/Exit Media Playback
MENU	Open / Close menu settings
USB	USB cable charging
	Connect the computer with USB cable

## Charging the battery

1. Power off your camera, open the battery cover and insert the battery in the direction as the shown of following picture, then close the battery cover.



2. You can use supplied USB cable to charge your camera via a adapter (5V/1A~5V/2A).

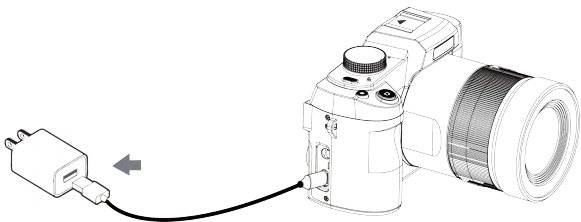

















- \* The charging indicator will be turned on in red when the battery is in charging.
- \* The charging indicator will be turned off automatically when the battery is fully charged.

Normally it takes around 2 hours to full charging of the battery.

When the battery is fully charged, the battery life is around 60 minutes for recording.

## Touch function

The display screen can touch the operation icon, and the corresponding functions are as follows.

Icon	illustrate
	Switching White Balance (Auto/Sunny/Sloudy/Fluorescent /Tungsten lamp)
	Switch Filter (None/Gray/Negative/Antique/Red/Green/Blue)
	Switch Metering Mode(Average Metering/Center Metering /Spot Metering/Matrix Metering)
	Switching ISO(Auto/100/200/400/800/1600/3200/6400)
	Enter menu settings
	Enter Media Library
	Enter system menu setting
	Return/Exit
	Open video file
	Open photo file
	Open Slide
	View the previous photo/video/page
	View next photo/video/page
	Delete photos/videos
	Start/pause playing video
	Start Slide Show
	Exit Slide

Touch the blank area of the display screen to hide all icons, and touch again to display all icons. All “sub menus” in menu settings can be operated by touch.



## Power on/off the camera

---

Press the power button, the camera will turn on automatically.

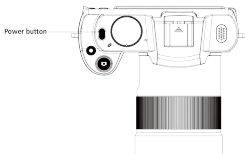

To turn off the camera, press and hold the power button for 3 seconds.

Note: When you turn on the camera for the first time, you need to press and hold the power button to turn it on.

When there is no battery in the battery compartment, you need to press and hold the power button to turn on the camera after you put the battery in.

## Set the camera

---

You can make custom settings of the camera.

After the camera is turned on, press the menu button to open the menu settings.

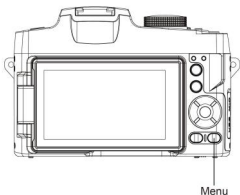

### Menu Settings

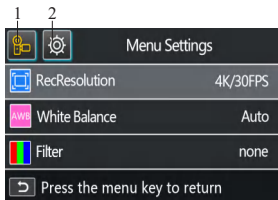

- 1 :Sub-menu for current mode
- 2 :System settings

<b>Sub-menu</b>	<b>Menu content</b>
Image Rotation	Turn On/Turn Off
Icon Display	Turn On/Turn Off
Video Focus Mode	Auto focus/Manual focus/Fixed focus
Wi-Fi	Turn On/Turn Off
Light Source Frequency	Auto/50Hz/60Hz
LED Indicator	Turn On/Turn Off
Auto Screen Saver	Turn Off/30s/1Minute/2Minute
Auto Power Off	Turn Off/3Minute /5Minute /10Minute
Display Brightness	High/Middle/Low
Button Prompt	High/Middle/Low/Turn Off
Startup Music	Turn On/Turn Off
Language	Simplified Chinese/traditional Chinese/English/ Japanese/Korean/ Russian/German/French/Italian/ Spanish/Portuguese/Thai
Time Format	YYYY/MM/DD MM/DD/YYYY DD/MM/YYYY
Time Set	hour minute second
Date Set	year month day
Format	(Micro SD Card)Format/Cancel
Device Info	Product model and version number
Factory Reset	Confirm/Cancel

# Insert and format the memory card

---

A class 10 or higher speed memory card is recommended to normal use.

1.Insert the memory card into the memory card slot until you hear a "click".



Insert the memory card in the direction shown in the diagram, paying attention to the edges and corners.

2.To remove the memory card:Push the memory card in and it will automatically pop out.

## Format the memory card

---

It is recommended to format the memory card before the first use.

To format the memory card, press the menu button to open the menu system.Then press the left or right button to switch to system settings. Press Up or Down to find "Format" and press OK to get the sub-menu. Select Format to format the memory card.

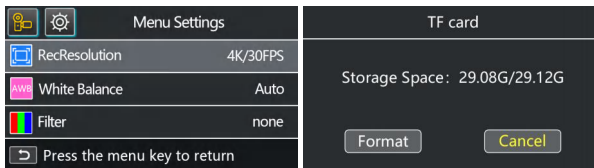

Note:If the memory card is not native format, the screen will pop-up a prompt:

“Unsupported file system,do you want to format?” please format the memory card as above operation.

Formatting the memory card will erase all the data stored on it and the data will be irrecoverable. Save your important data on PC before formatting.









# Using the camera

---

After the camera is turned on, it defaults to video shooting mode.



Rotate the mode dial to select the desired mode

icon	Mode	illustrate
	Photo	Take a single photo normally
	Auto	Automatically cycle take photos after a specified number of seconds
	Timed	Take a single photo after a specified number of seconds
	Burst	Take a specified number of photos in succession
	Video	Normal recording mode
	Slowly	Slow motion shooting
	lapse	Compress time to record video
	Loop	Recording infinite loop
	Video+Photo	During the recording video, you can capture according to the set capture interval single photo

Note: The camera supports setting the corresponding mode menu in different modes. After selecting the desired mode, press the menu button to open the menu and select the desired setting if desired.

Press the photo button to take a photo, and the photo will be automatically saved to the memory card.

Press the Record button to start shooting video, then press the Record button to end shooting video, you can press Power to pause or continue video shooting while shooting video.



1: Photo button (Taking pictures/focusing)

2: Video button (Start recording/End recording)

3: Indicator light

The working indicator light flashes when recording

4: Digital zoom button

T button digital zoom zoom in/W button digital zoom zoom out

(Double-finger zooming in and out on the camera screen allows the camera to digitally zoom in and out.)

## Focus function

This function includes 3 focus modes: Auto focus/Manual focus /Fixed focus. Press menu button Open the menu, then press the left/right button to switch to system settings, press the up/down button to find "Video Focus Mode", press OK button to enter focus mode. Select the mode you need.

### Auto focus

In this mode, you only need to keep the camera steady when taking pictures or videos, and the camera will automatically focus. Once done, press the capture button.

### Manual focus

In this mode, when taking a photo or recording a video, half-press the photo button and the focus frame will appear on the display until the camera focuses clearly.

Then press the photo button all the way down to take the clearest photo or start recording with the clearest image.



### Macro

In this mode, point the camera at the subject (more than 5CM away). When the subject is clearly visible on the camera screen, hold the camera steadily and press the photo button to take photos and videos.

### Fill light

In video mode, pressing the up button can quickly turn on or off the fill light.

In photo mode, the fill light has three flash modes and pressing the up button can quickly switch between the three modes.

	No flash
	Auto flash
	Mandatory flash

Note: When the fill light is in automatic flash mode, it will only flash when taking photos in a relatively dark environment. When switched to forced flash mode, the fill light will always be on.

# Playback

Press the playback button to enter the media library. Select the video or photo file you want to view, then press the OK button to enter the corresponding file to view the video and image stored in the camera memory card.

Current/total number of images

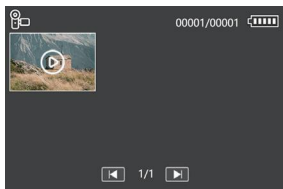

Figure 1: Video playback

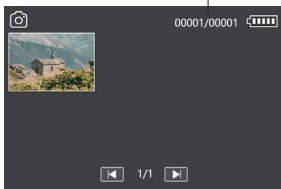
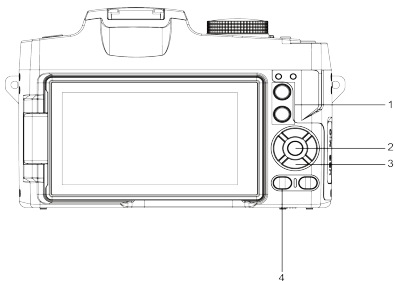

Figure 2: Photo playback



1: To view the details of a captured photo you can press T/W (T to zoom in, W to zoom out).

Note: After zooming in you can press up/down/left/right to move around to see more details.

2: Press the OK button to play/pause the video

3: Press the down button to delete a photo/video.

Note: Once deleted, it cannot be recovered.

4: Press the playback button to exit video/photo playback

# Connect to computer

---

1. Connect the Type-C USB port of the camera and the USB port of the computer with supplied USB cable.

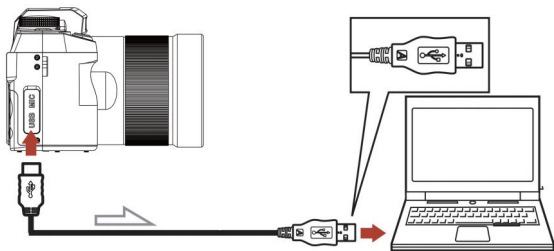

2. The camera will turn on automatically and the screen will display the available options.  
Press the Up/Down button to select the desired option, then press the OK button to confirm the option.

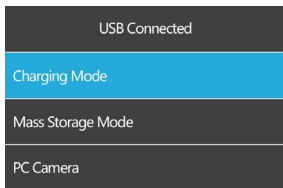

## Charging Mode

Select the charging mode, the camera supports the function of recording normally. Power off the camera would be fully charged faster then keep powering on.

## Mass Storage Mode

Select "Storage Storage Mode" and the computer will display the camera's memory card drive. You can transfer files from the storage to the computer on the computer.



## PC Camera

Select the “PC Camera” mode, the camera can be used as a webcam, live streaming, etc.

Note: When the camera is used as a webcam, only the digital zoom button can be operated on the camera and other functions cannot be used.

## Connect to the Zero CAM app

Using the camera’s built-in Wi-Fi allows you to operate the camera (take photos/videos) and easily download photos/videos from the camera to your smartphone.

## Download the app and connect the camera’s Wi-Fi network

Search for “Zero CAM” from Google play (Android) or Apple app store (iOS) to download the app.

After the camera is turned on, long press the right button to directly turn on WiFi. Or press the menu key to enter the menu, then press the left/right key to switch to system settings, then press the up/down key to find the "WiFi" submenu, and press the OK key to turn on WiFi. The WiFi ID and password will then be displayed on the camera screen.



On your smartphone, go to Settings—WLAN—4K\_WIFI and enter the password according to the camera screen.

Note: The camera's Wi-Fi cannot access social networks, only for smartphones to access the camera.

## System requirement (of smartphone):

\* Android 6.0 or higher is required

\* iOS 8.0 or higher is required

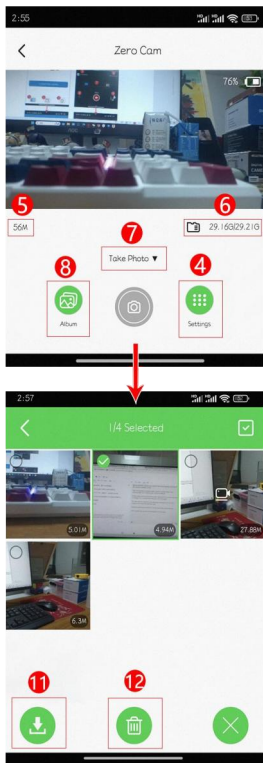

- 1: Click through the APP to view the live view and operate the camera
- 2: View images/videos downloaded to your smartphone from the app
- 3: System Settings
- 4: Camera settings
- 5: When pixel/resolution
- 6: The remaining storage space of the memory card
- 7: Switch the shooting mode of the camera
- 8: Switch the pixel/resolution of the current mode
- 9: View images/videos saved on the camera
- 10: Delete images/videos downloaded from the app to your smartphone
- 11: Share images/videos downloaded from the app to your smartphone to social software
- 12: Delete images/videos from the camera

## **Camera cleaning and maintenance**

- (1) If you do not use the camera for a long time, take out the camera battery and place it in a dust-free, dry environment with a temperature no higher than 30 °C .
- (2) In order to extend the service life of the battery, please discharge it completely before storage.
- (3) Please fully discharge the battery at least once every 3 months after it has been fully charged.
- (4) If there is dust or dirt on the lens or screen, gently wipe it with a clean, soft lens cleaning cloth.
- (5) As this machine is a precision instrument, please do not drop it or suffer from strong impact or vibration.

## **Troubleshooting:**

If you encounter problems with the camera, please refer to this section.

### **1. The camera cannot be turned on after installing the battery**

- (1) The battery power is insufficient, please replace the battery with a new one or charge the battery.
- (2) The battery is installed in reverse, please confirm that the battery is installed in the correct way.
- (3) The battery insulating paper is not removed.

## **2. The battery is not charging**

- (1) If the red light of the charging indicator flashes, the battery is not in place or the contact is poor. Please re-install the battery until the indicator light is on (the indicator light goes out when the battery is fully charged)
- (2) The charging indicator light is off and the charger is not plugged in properly. Please check whether the charger is connected normally.
- (3) The ambient temperature is lower than 10°C, which may lead to slow charging or failure to charge.

## **3. Camera crashes**

Quickly pressing each button of the camera may cause the camera to freeze. After it crashes, unplug the battery and reboot.

Tip: When the camera is recording or taking pictures, do not quickly press the camera button. Under normal circumstances, the camera will display a waiting icon.

## **4. The memory card cannot be recognized:**

- (1) Please check whether the memory card complies with Micro SD card (class10), the maximum is not more than 256G.
- (2) Please check whether the memory card is inserted backwards.
- (3) When the memory card is used on the camera for the first time, it is recommended to format it first.

## **Additional notes**

- (1) Do not insert any object into the slot except the memory card.
- (2) After the power is turned on, the camera may show an unstable image about for a few seconds, but this is not a fault.
- (3) Due to the optical properties of the lens, there may be color dispersion (magnification of chromatic aberration) at the edges of the image. This is not a camera fault.
- (4) It is normal for the memory card to get hot after a long period of use.
- (5) It is normal for the camera's screen to heat up after a long period of use.

**Warning:**

Changes or modifications to this unit not expressly approved by the party responsible for compliance could void the user's authority to operate the equipment.

**NOTE:**

This device complies with part 15 of the FCC Rules. Operation is subject to the following two conditions: (1) This device may not cause harmful interference, and (2) this device must accept any interference received, including interference that may cause undesired operation.

**FCC Statement:**

This equipment has been tested and found to comply with the limits for a Class B digital device, pursuant to part 15 of the FCC Rules. These limits are designed to provide reasonable protection against harmful interference in a residential installation. This equipment generates, uses and can radiate radio frequency energy and, if not installed and used in accordance with the instructions, may cause harmful interference to radio communications. However, there is no guarantee that interference will not occur in a particular installation. If this equipment does cause harmful interference to radio or television reception, which can be determined by turning the equipment off and on, the user is encouraged to try to correct the interference by one or more of the following measures:

- Reorient or relocate the receiving antenna.
- Increase the separation between the equipment and receiver.
- Connect the equipment into an outlet on a circuit different from that to which the receiver is connected.
- Consult the dealer or an experienced radio/TV technician for help.

**RF exposure compliance statement:**

This device has been evaluated to meet the general RF exposure requirement